



Nilfisk



128336341 (10.2020)

Kornmarksvej 1|DK-2605 Broendby|Denmark|Tel.: (+45) 4323 8100

Quick Start Guide High Pressure Washer Core 125

Caution: Read the instructions before using the machine

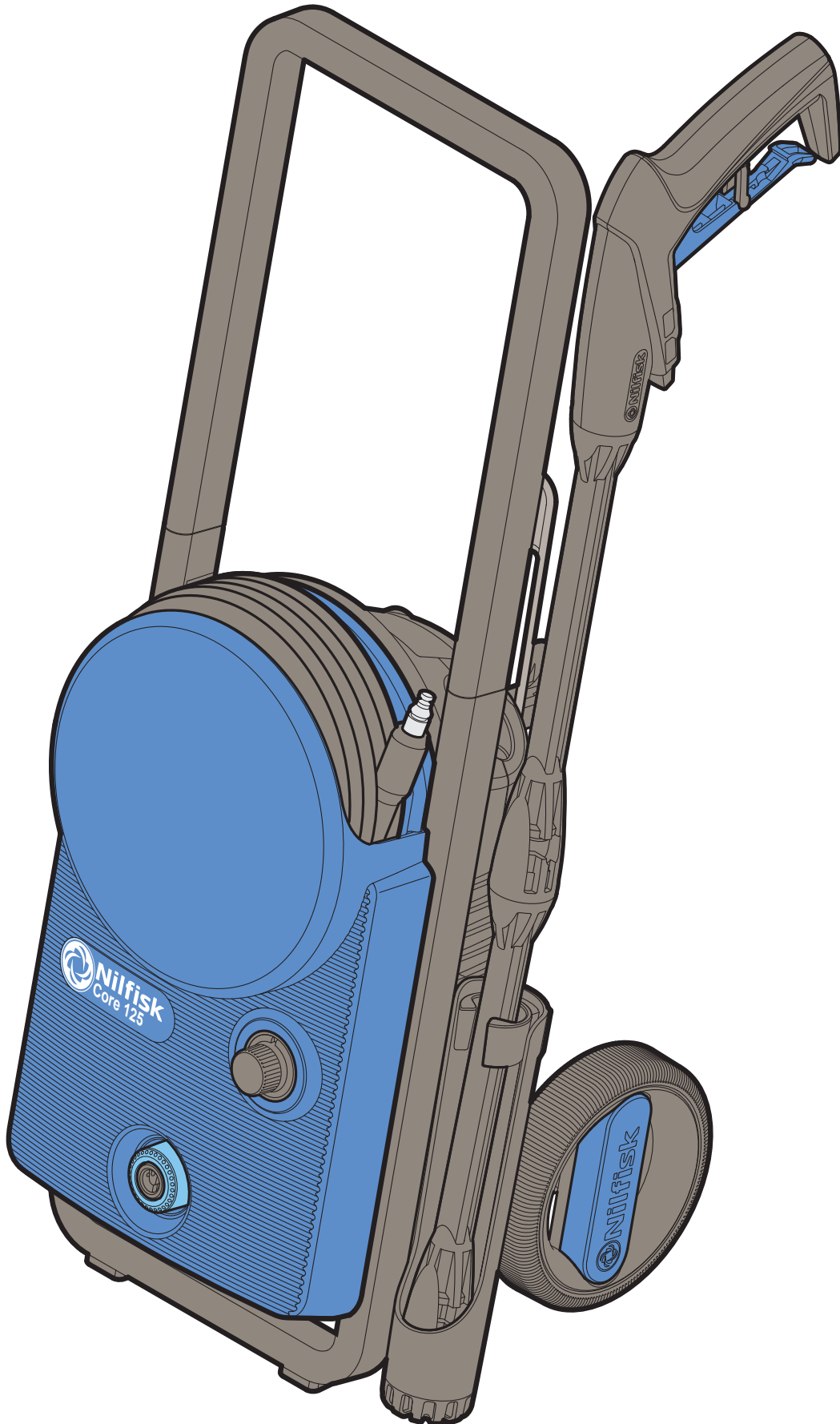

Core 125

A

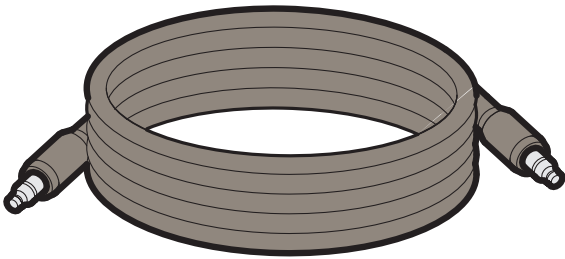
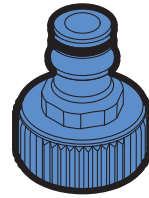
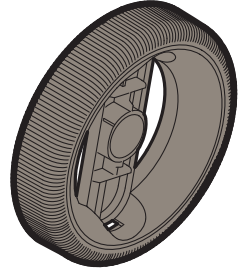
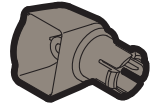
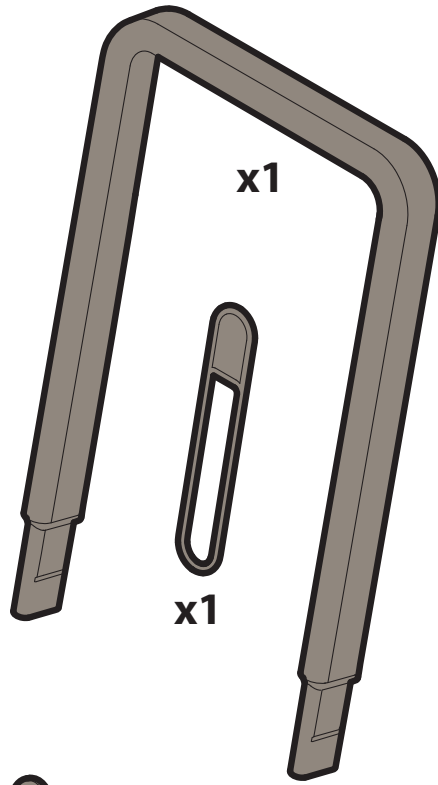
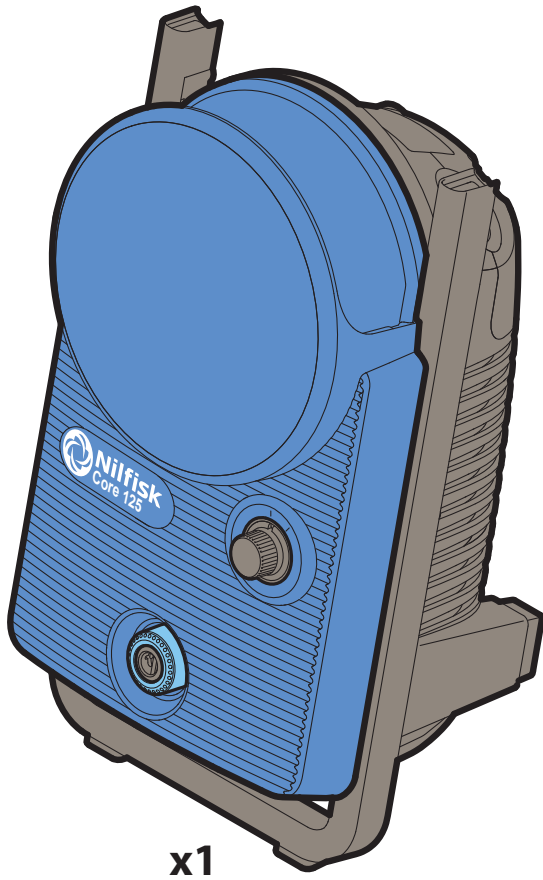

x1

x1

x1

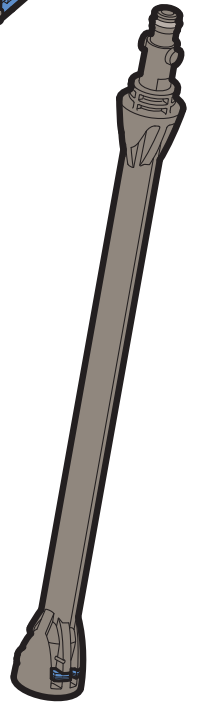
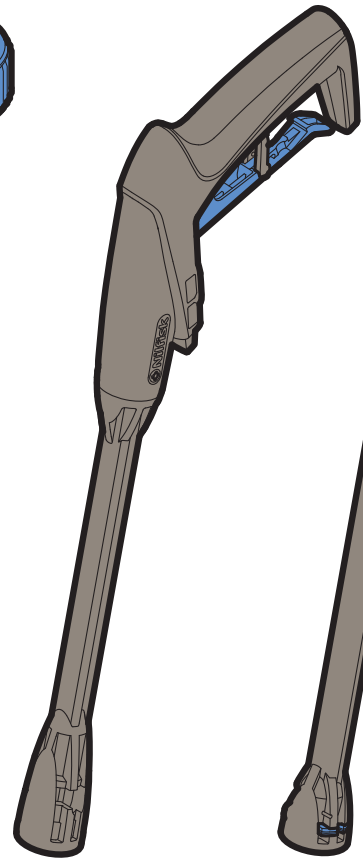
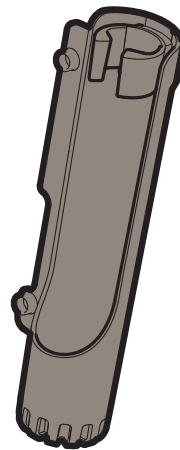
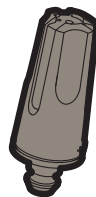
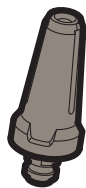

x1

x1

x1

x1

x1

x1

Core 125

A



1

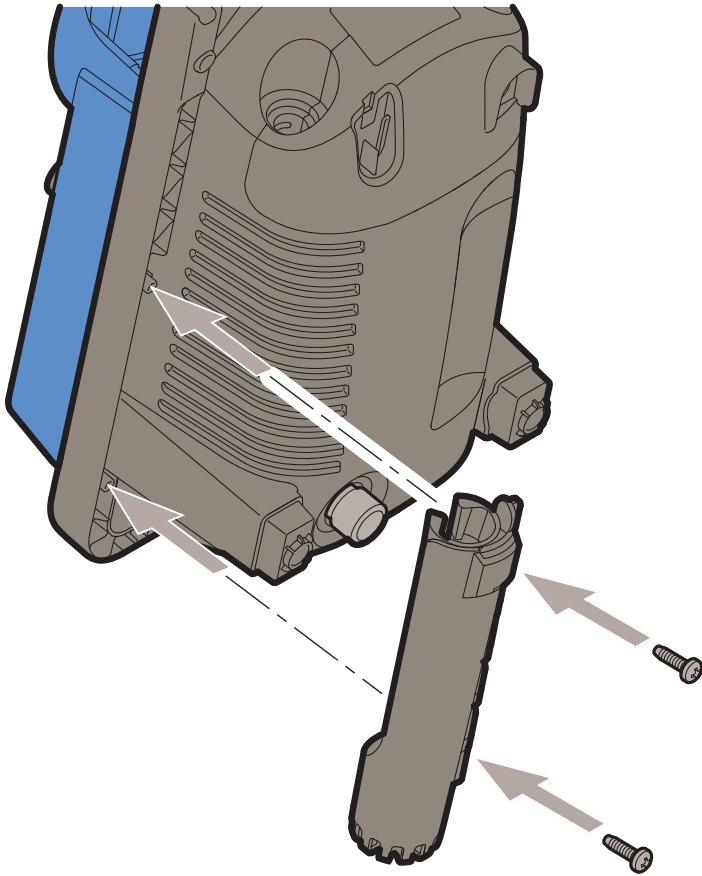

2

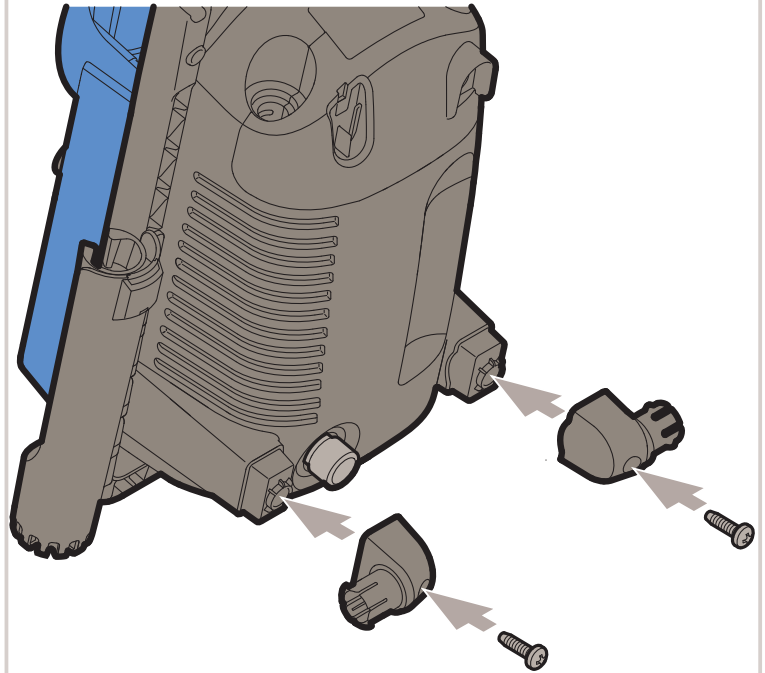

3

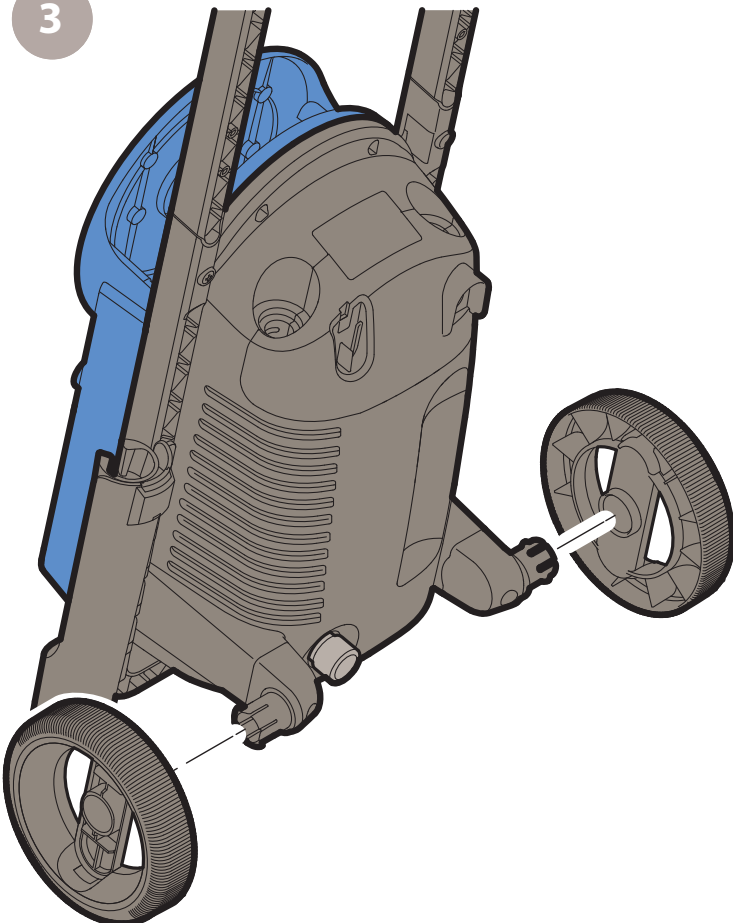

4

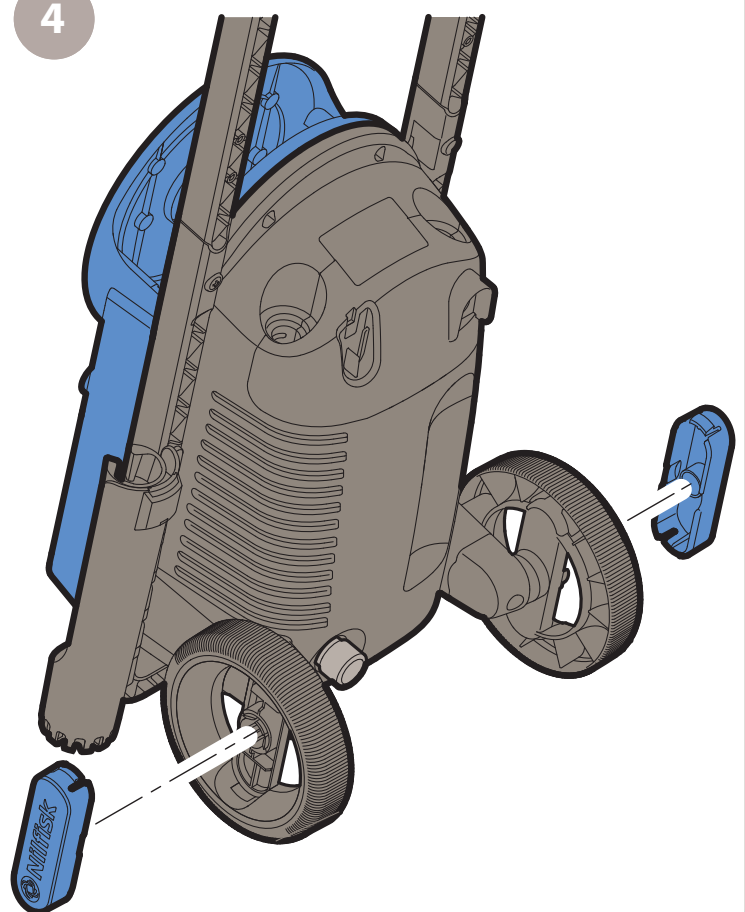

A



5

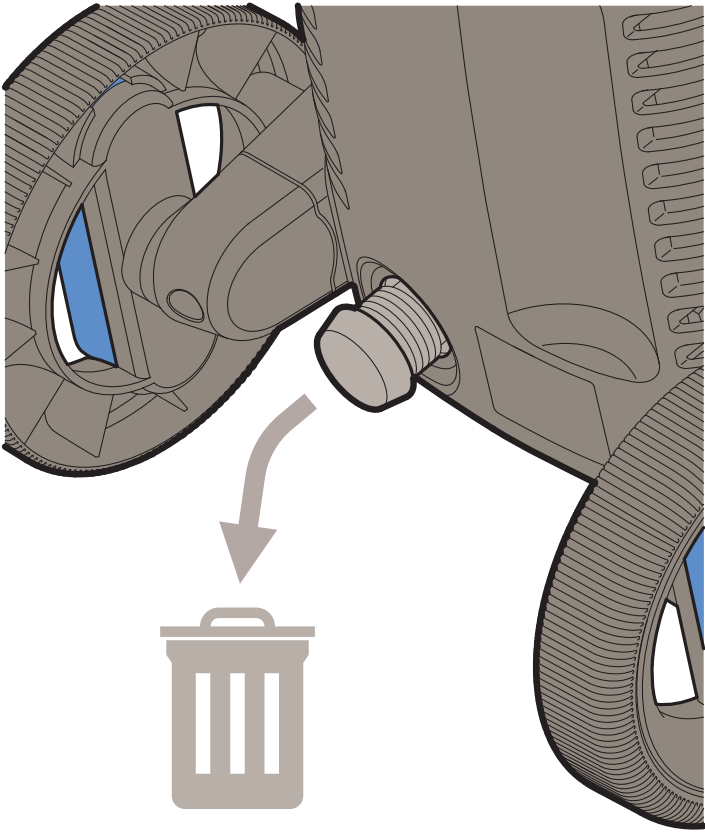

6

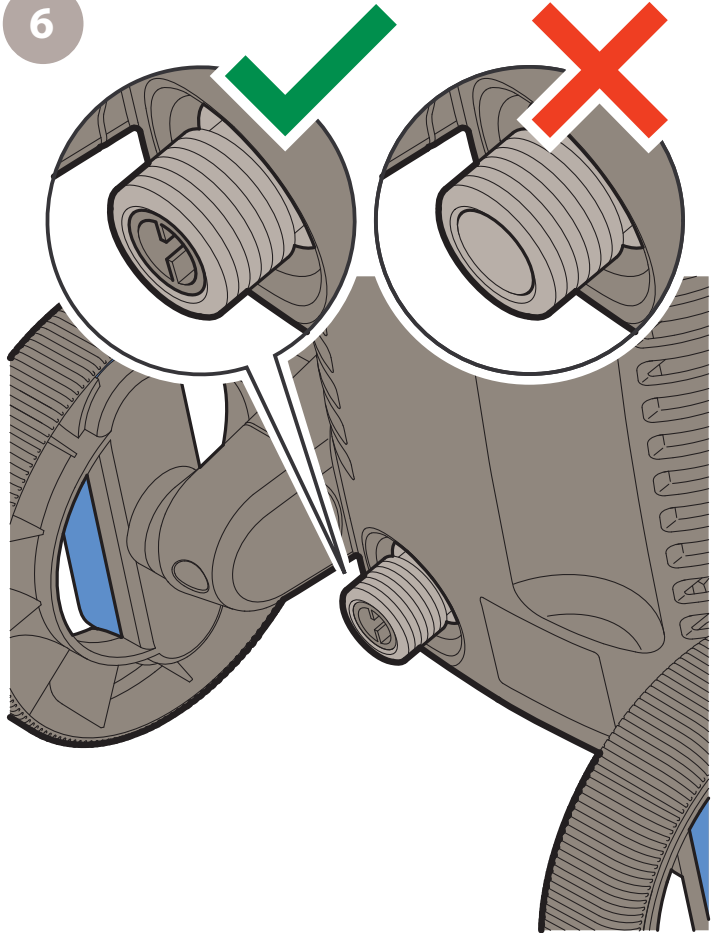

7

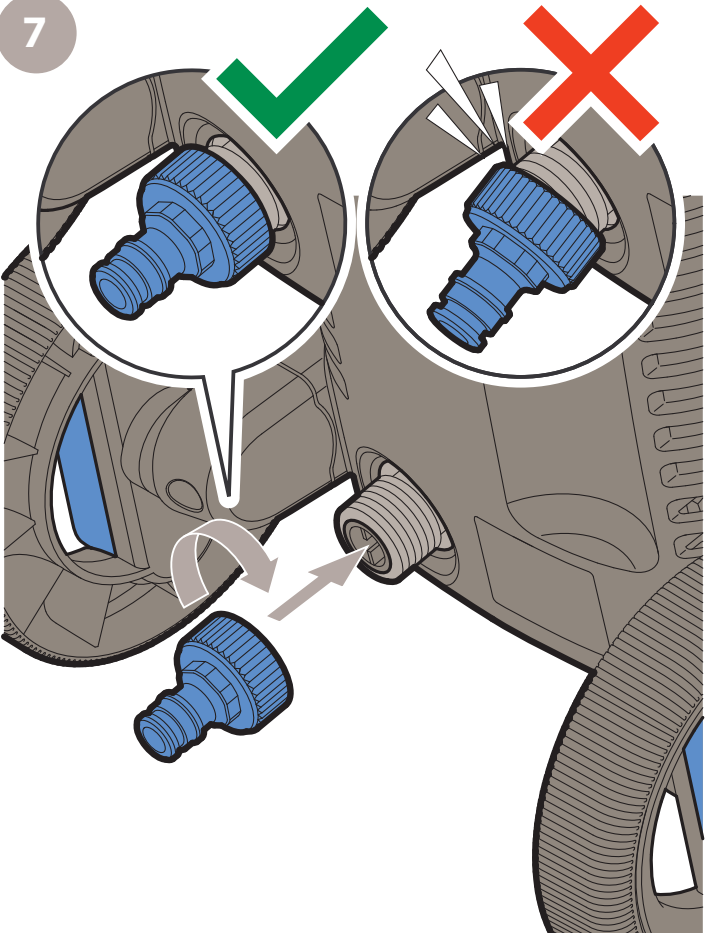

8

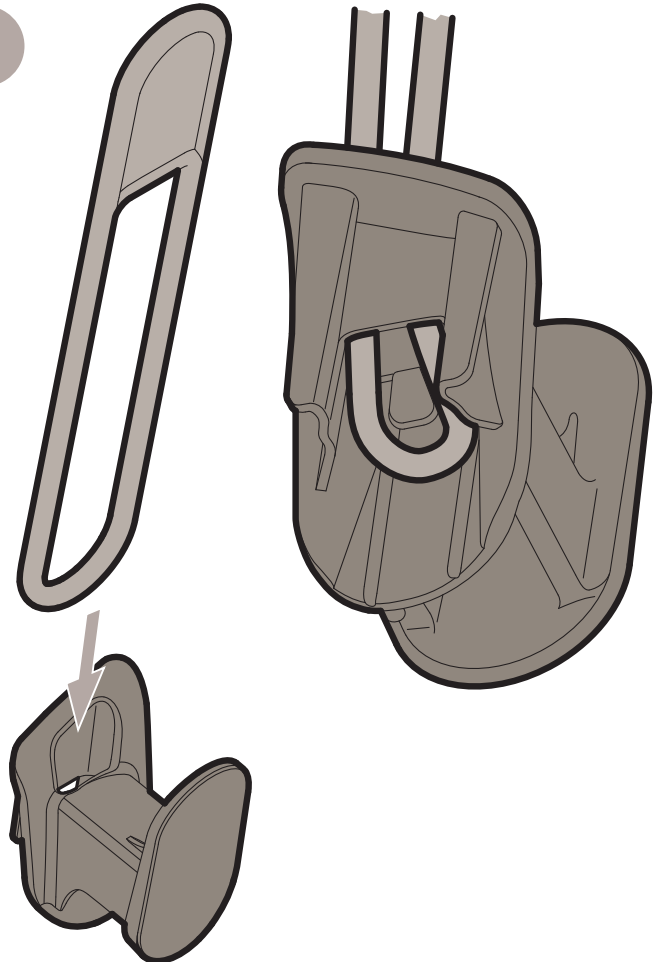

A



9

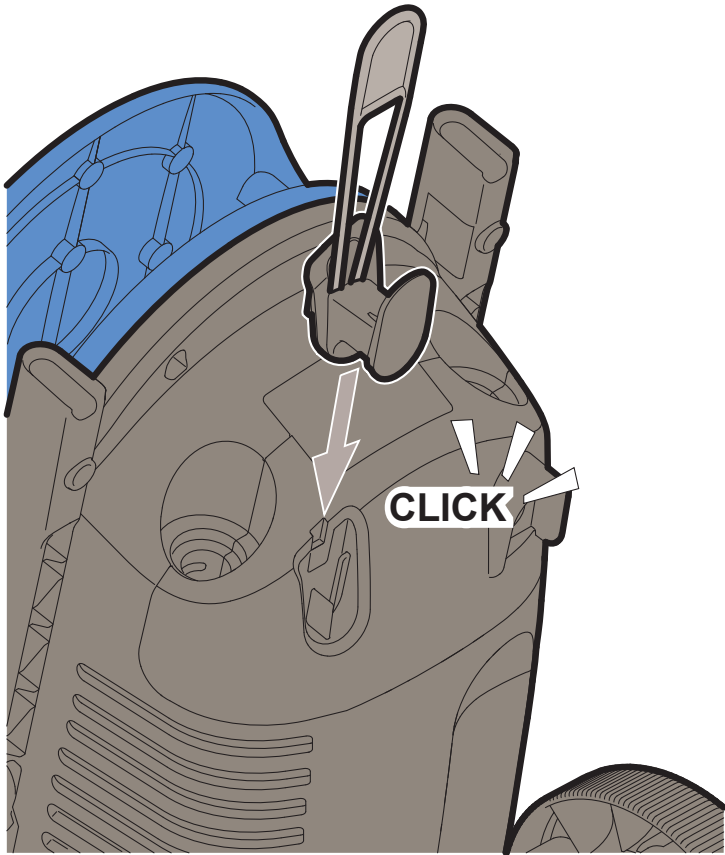

10

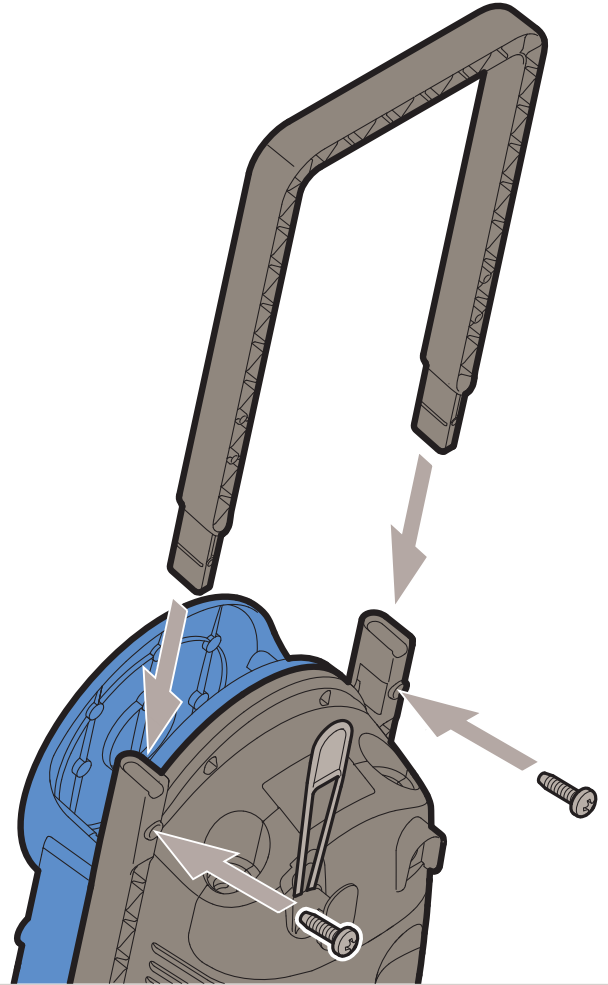

11

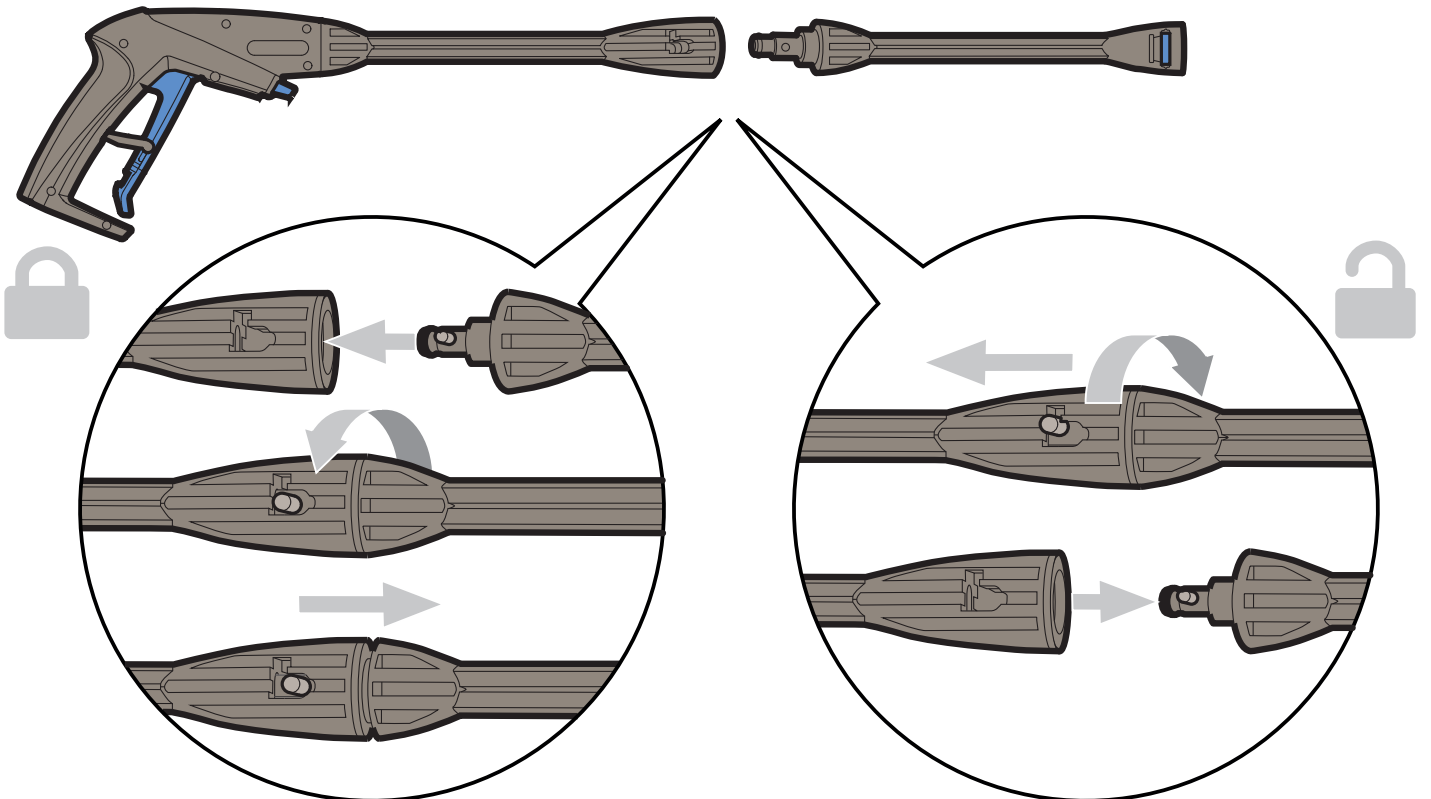

A



12

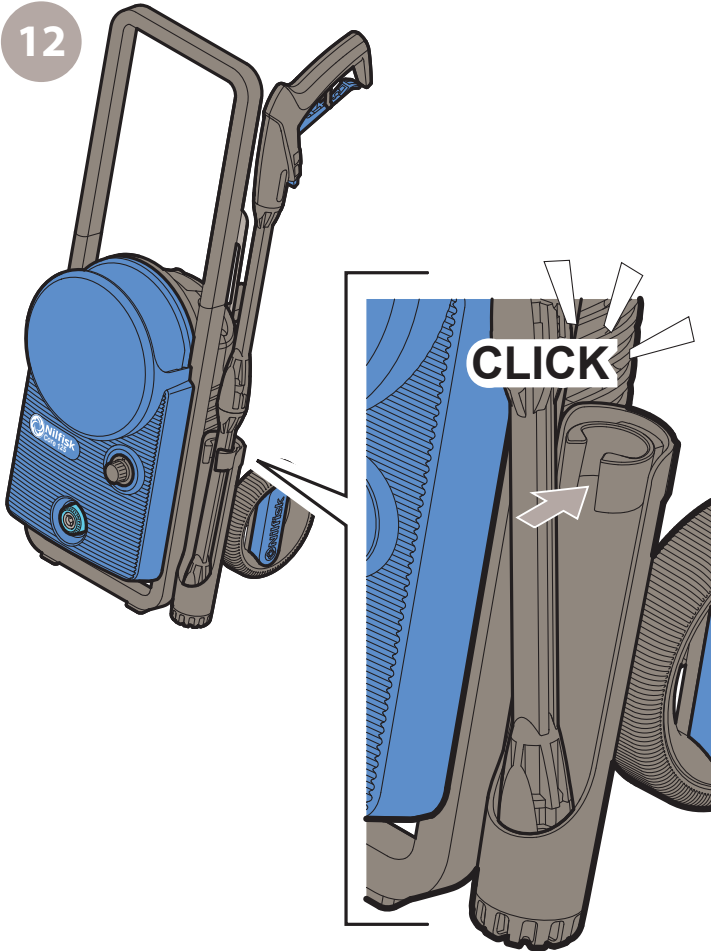

13

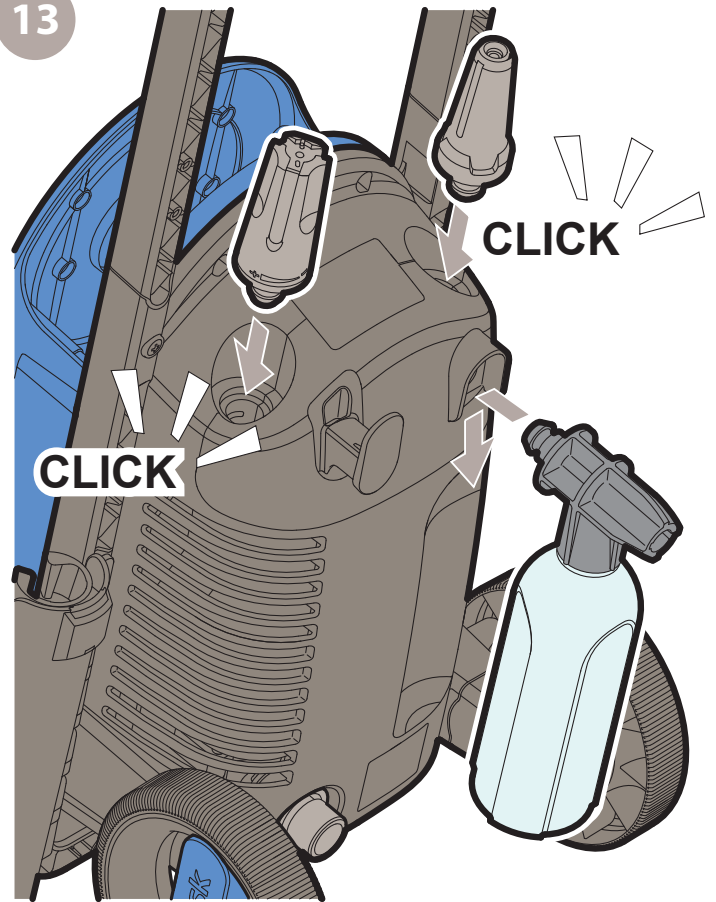

14

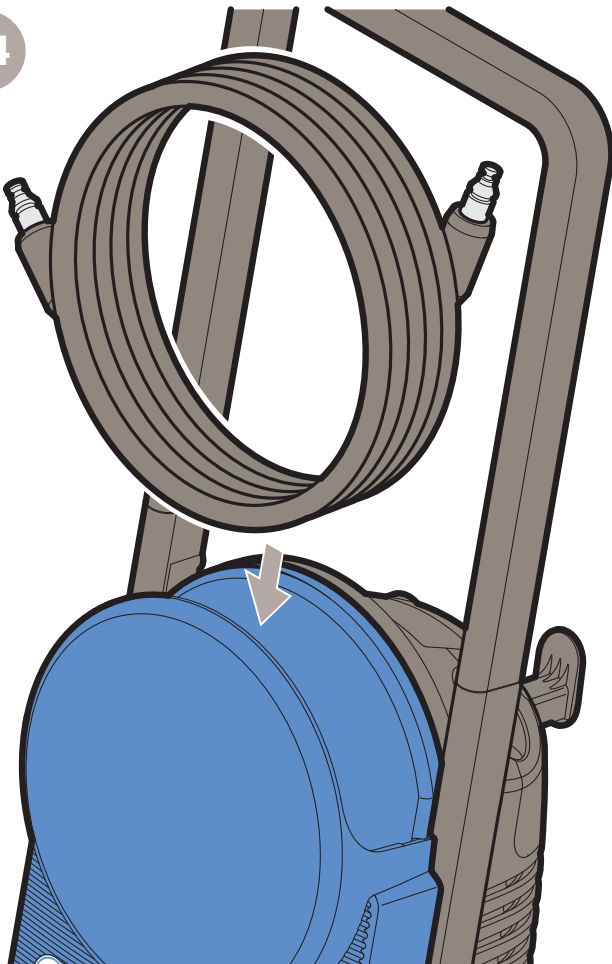

15

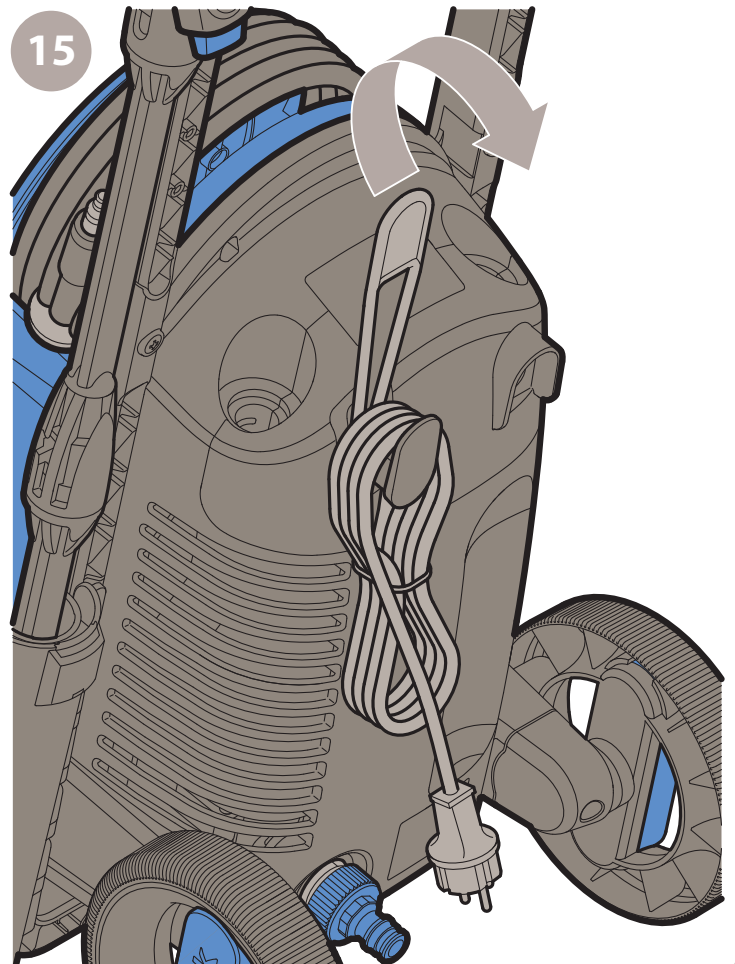

B



1

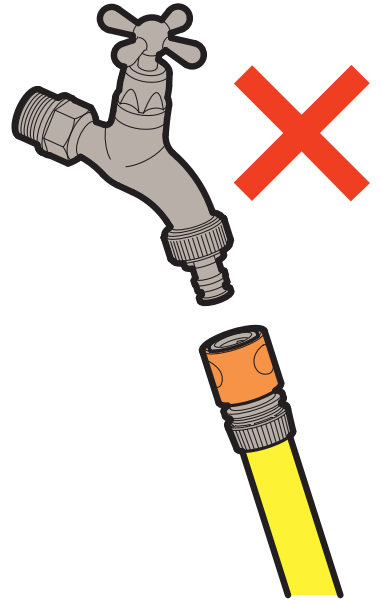
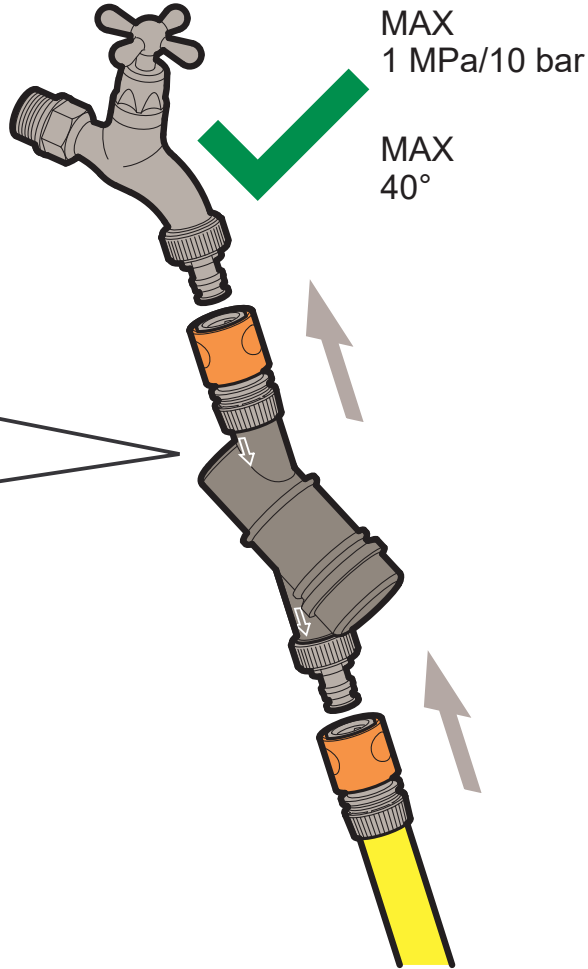
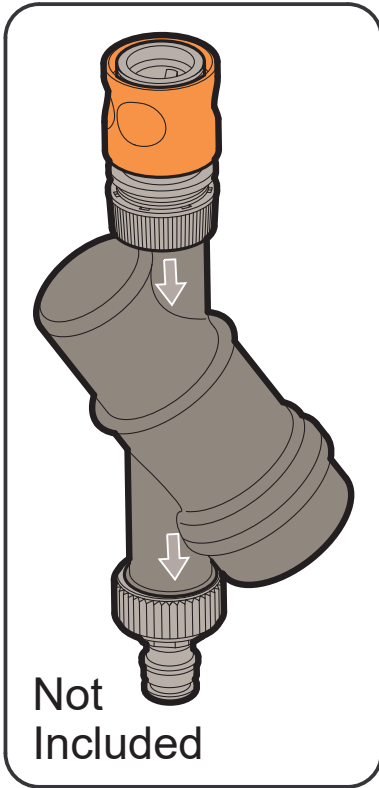

2

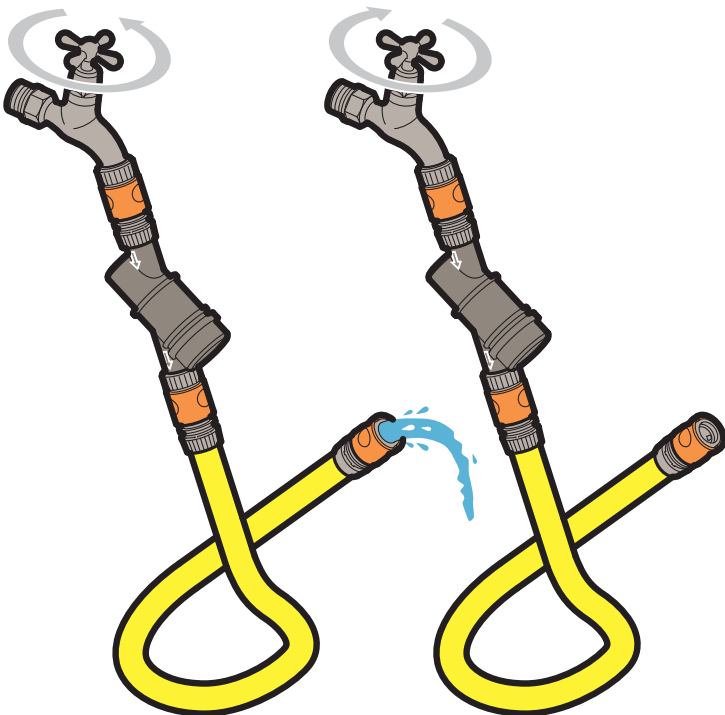

3

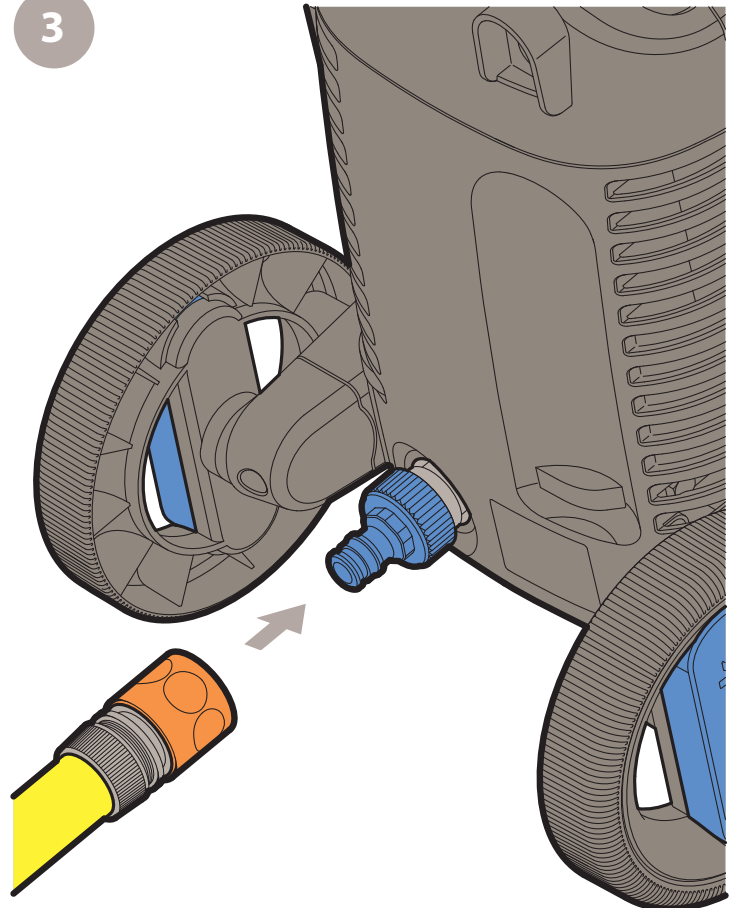

B



4

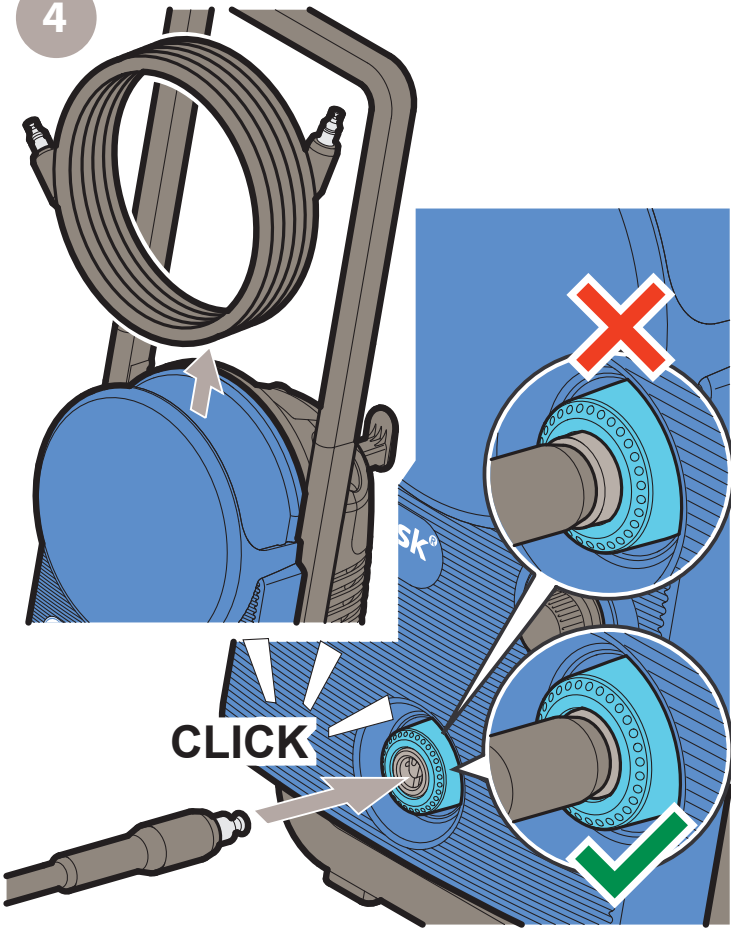

5

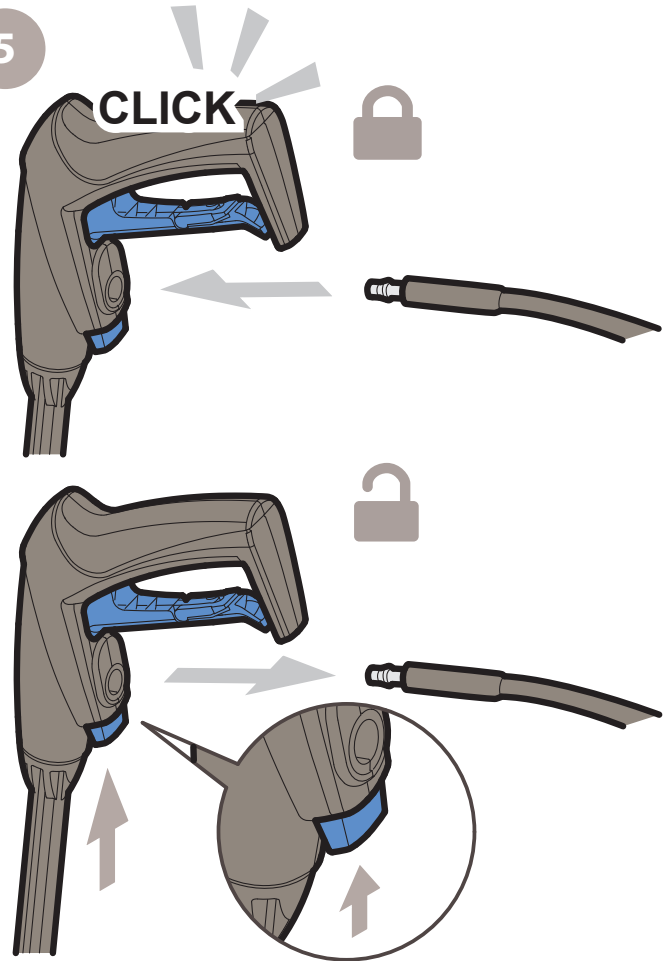

6

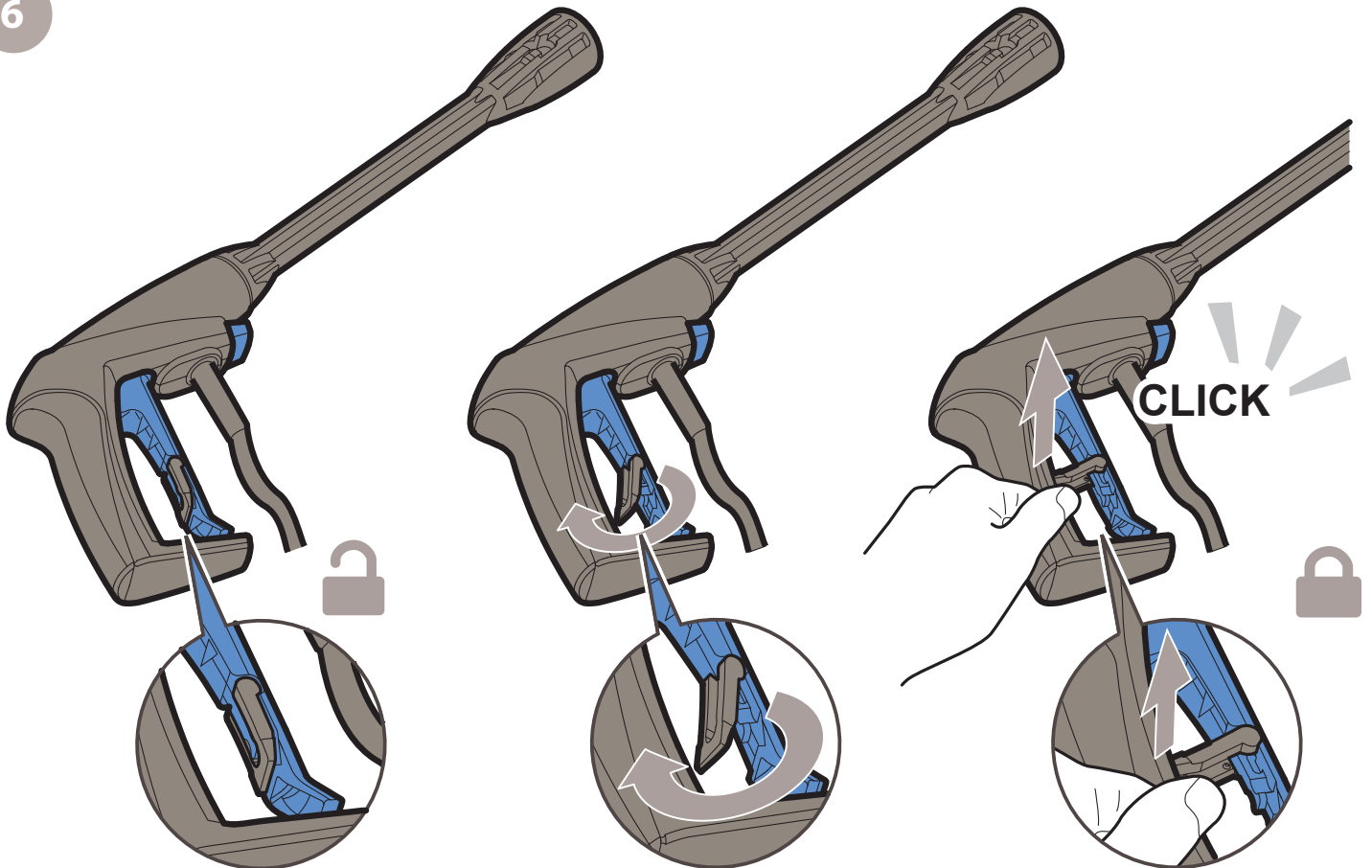

B



7

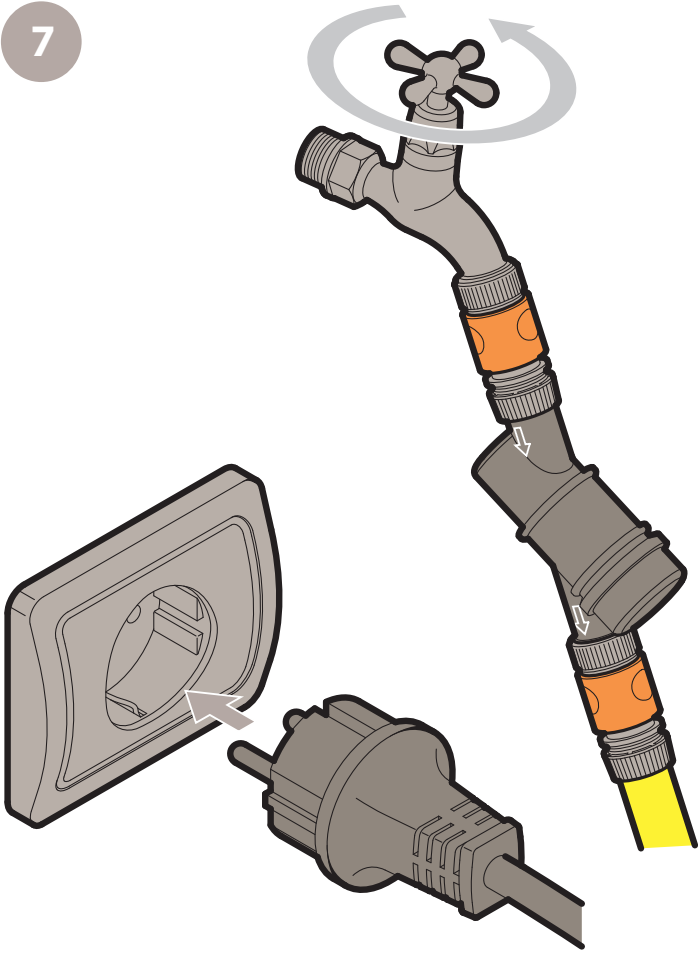

8

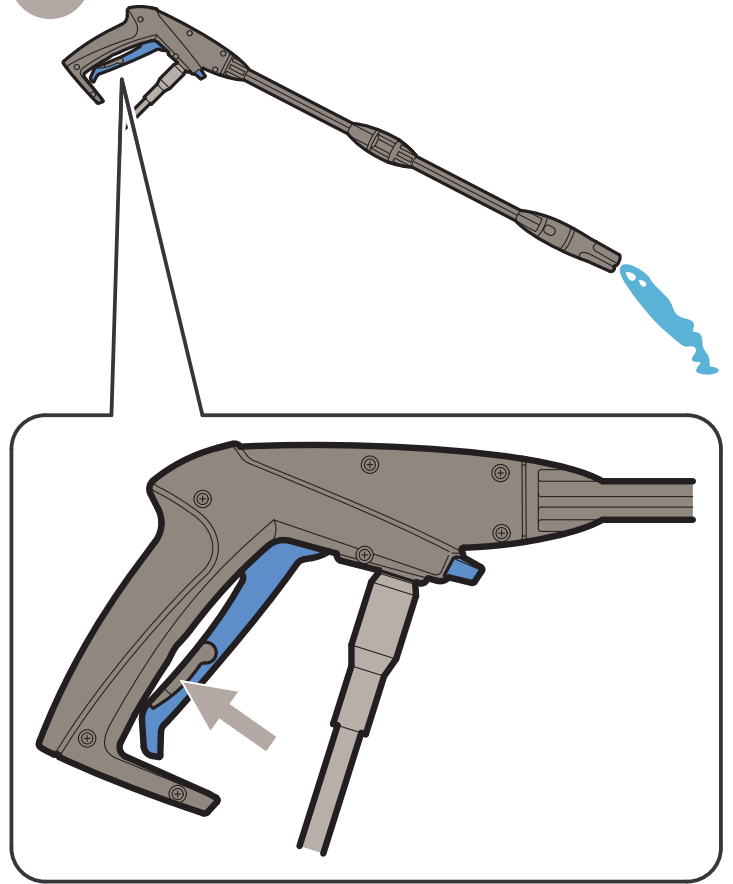

9

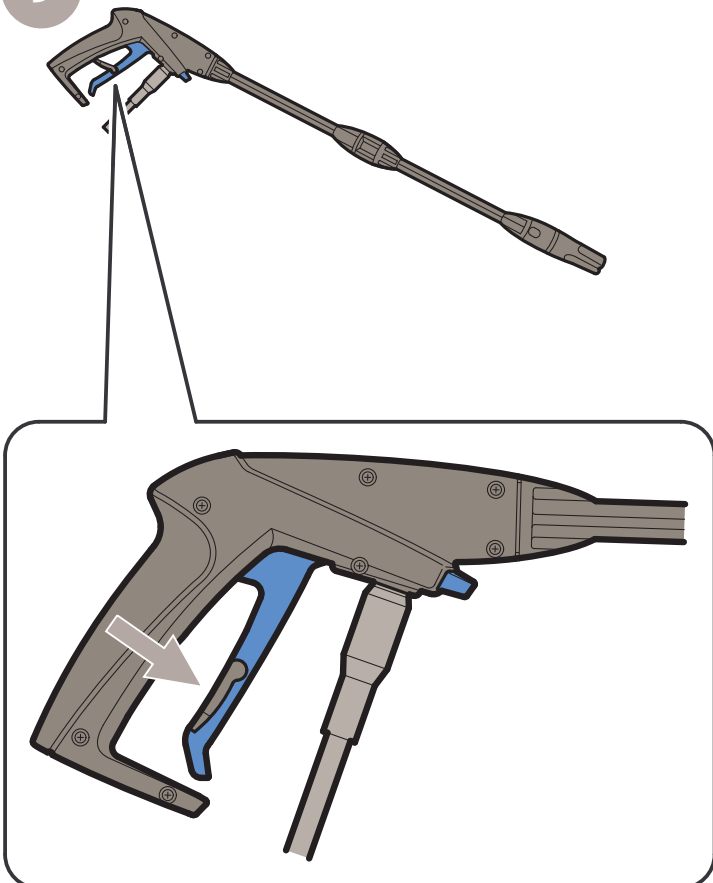

10

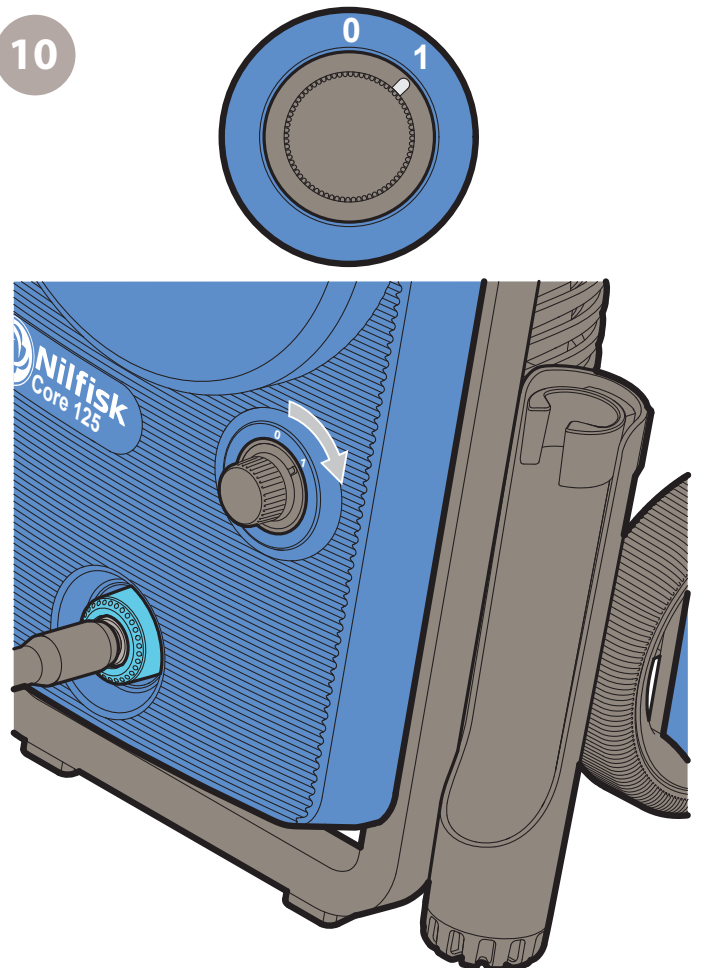

B



11

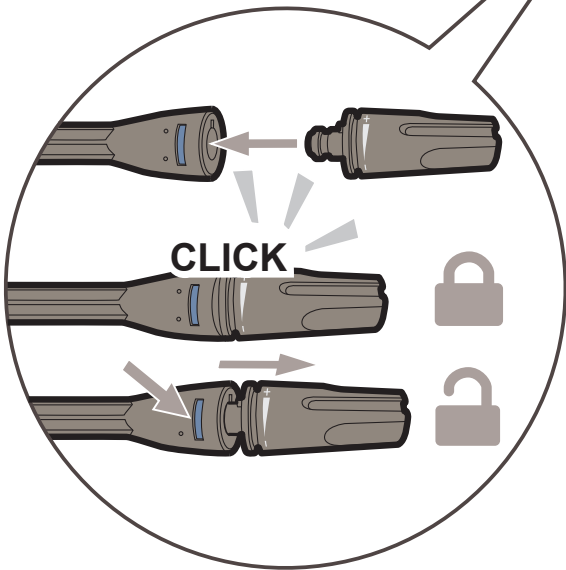
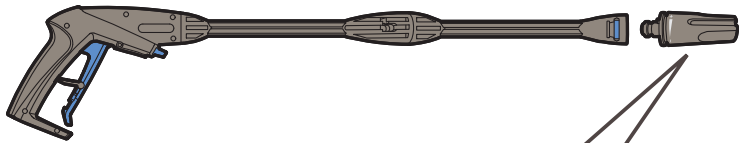

12

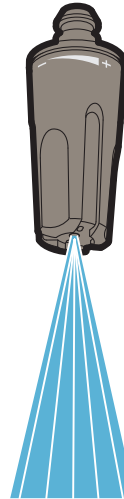

GENTLE NOZZLE

ROUGH NOZZLE



HARD SURFACES ONLY

13

MAX MPa/bar



MIN MPa/bar

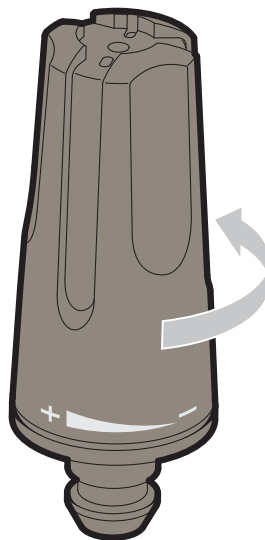
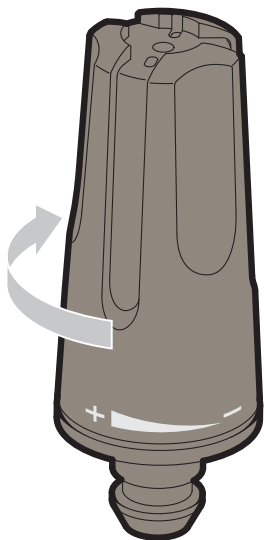

GENTLE NOZZLE

14

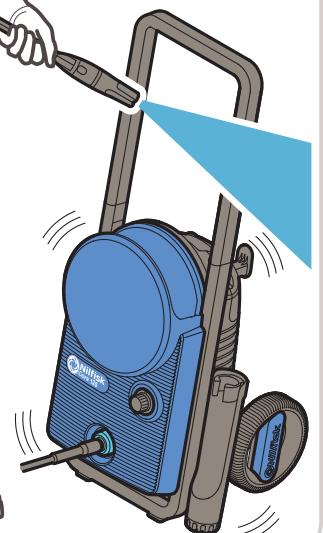
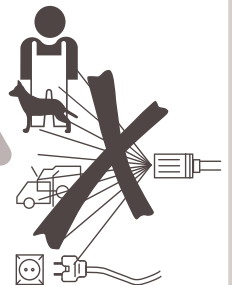

C

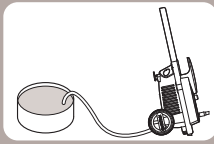

1

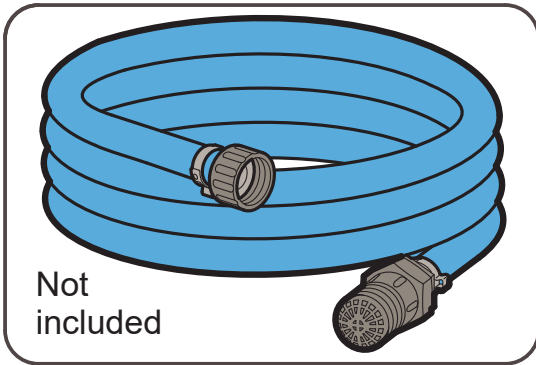

Not included

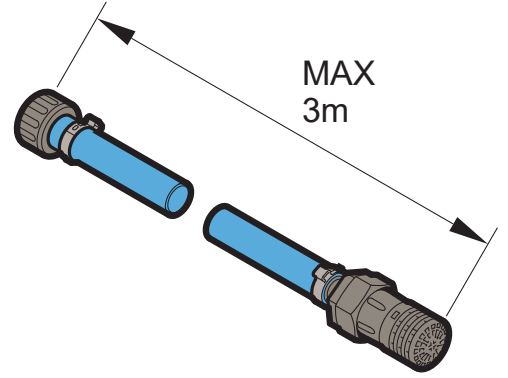

MAX
3m

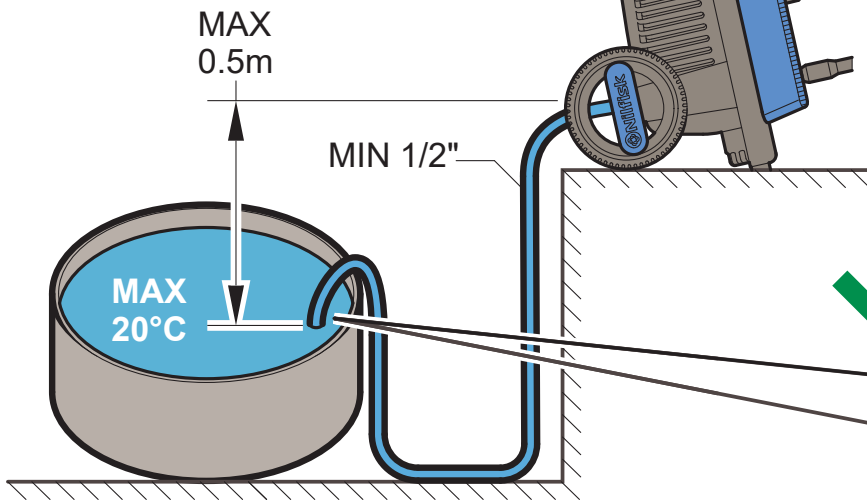

MAX
0.5m

MIN 1/2"

MAX
20°C

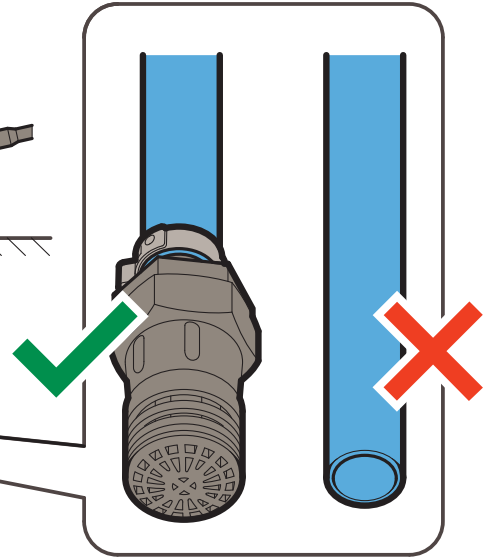

2

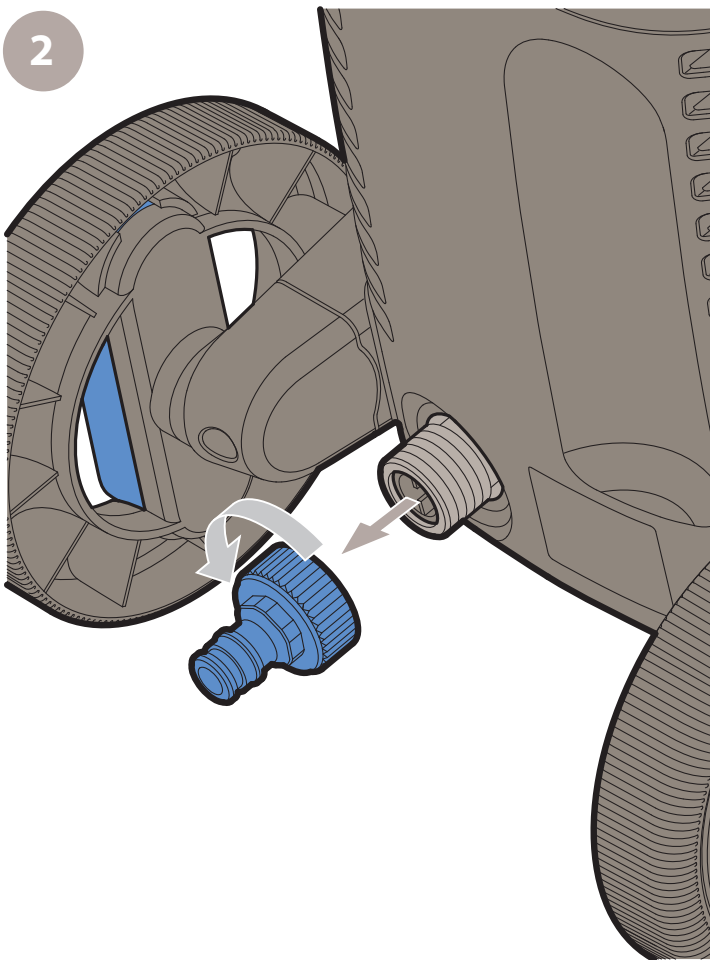

3

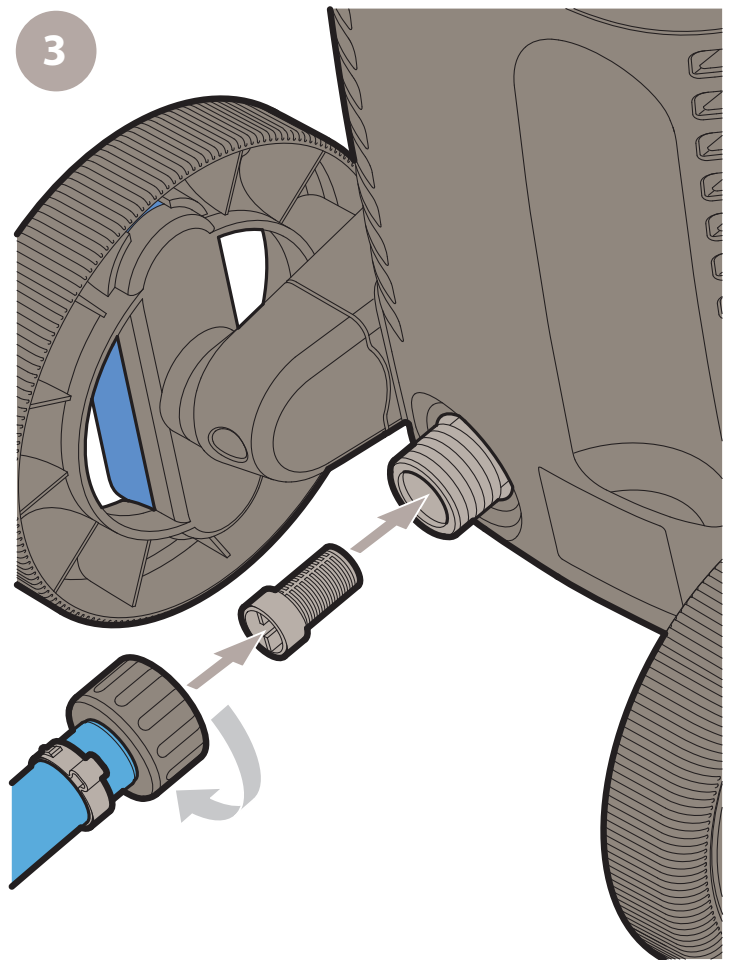

C

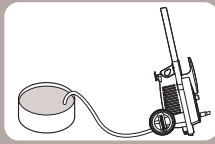

4

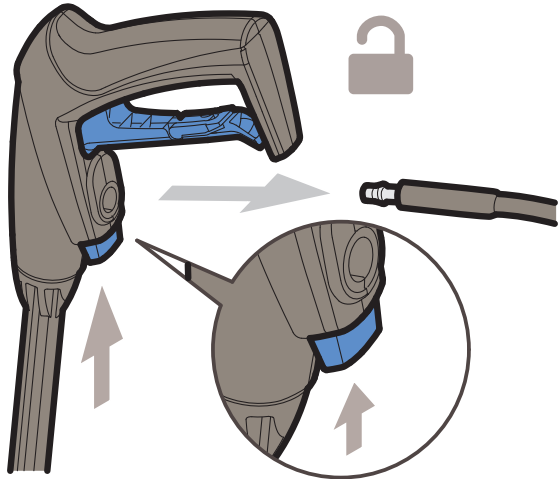

4.1

4.2

5

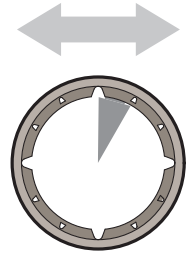
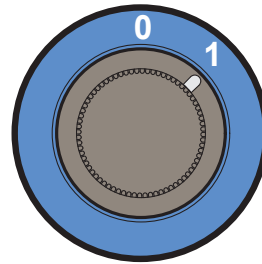

MAX 2min



6

6.1

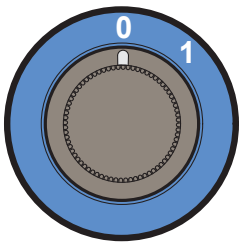

6.2

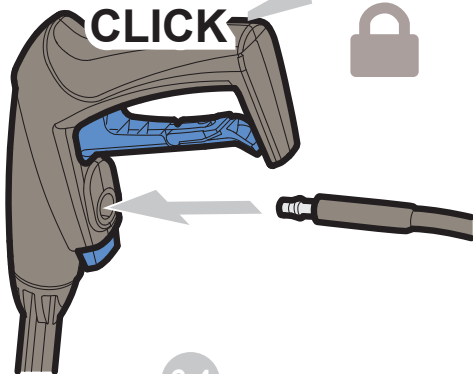

6.3

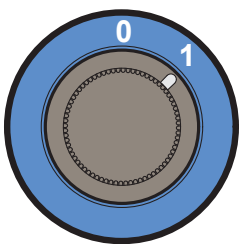

6.4

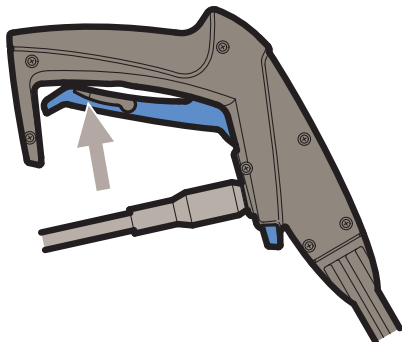

7



D



>5min



1

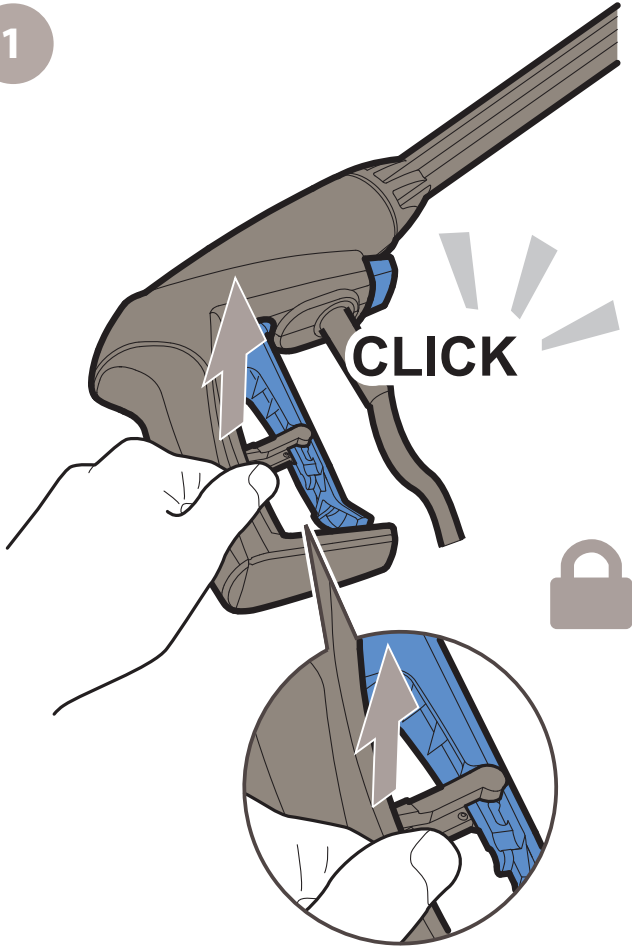

2

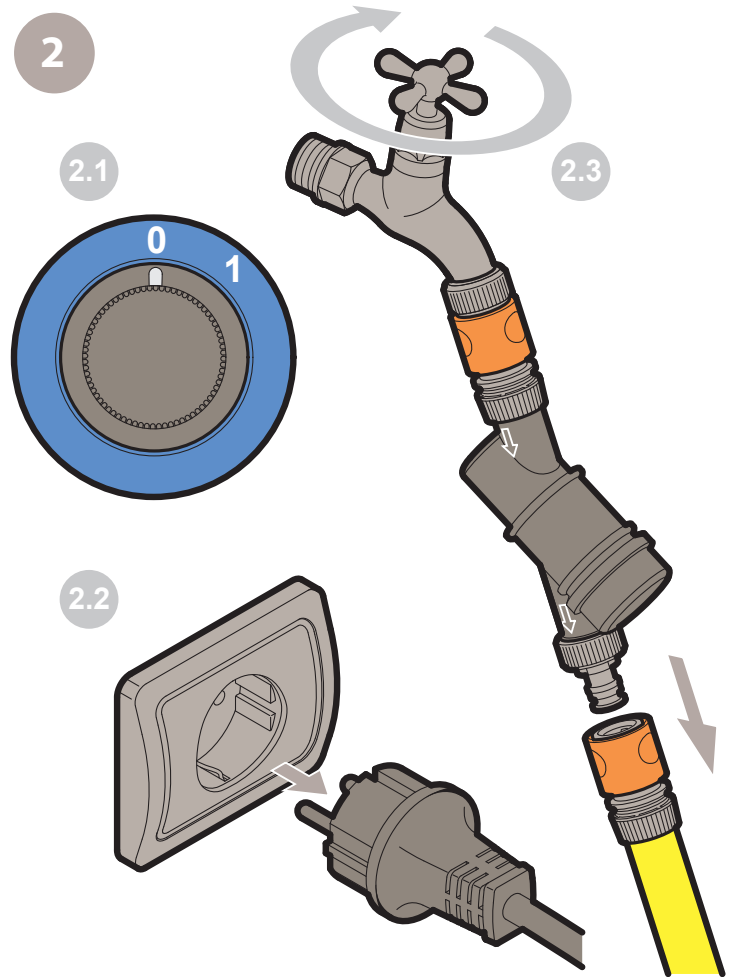

E

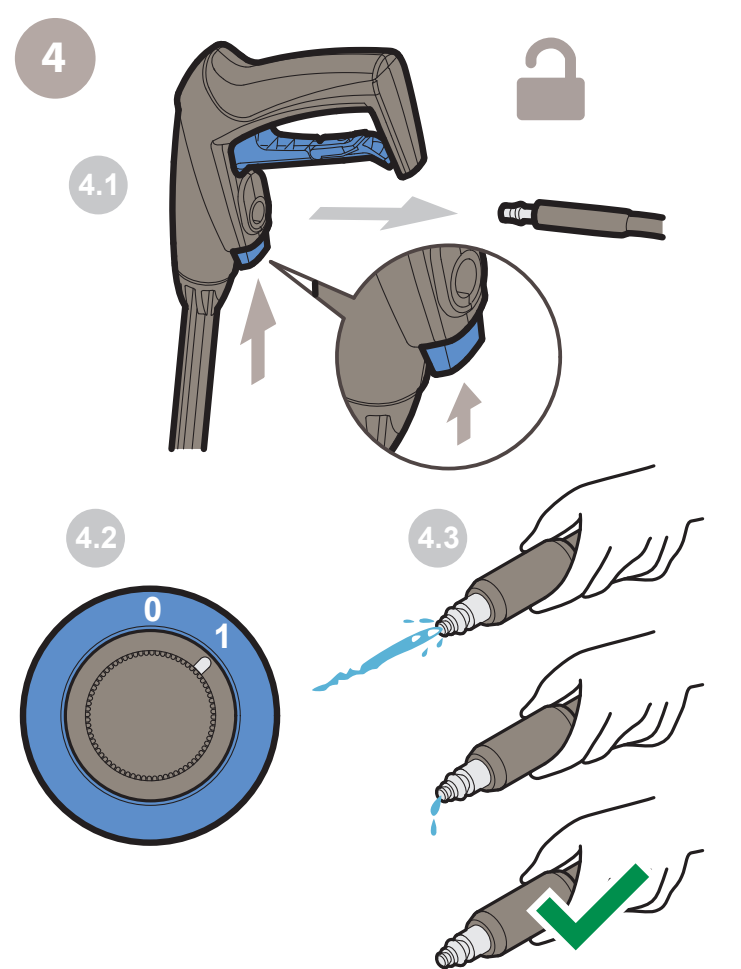
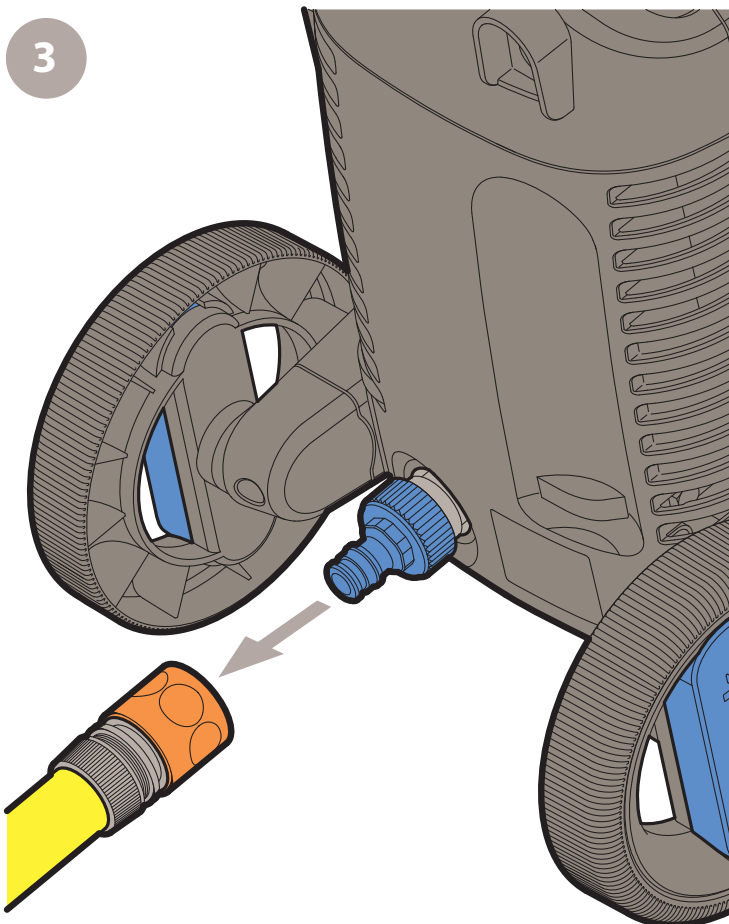
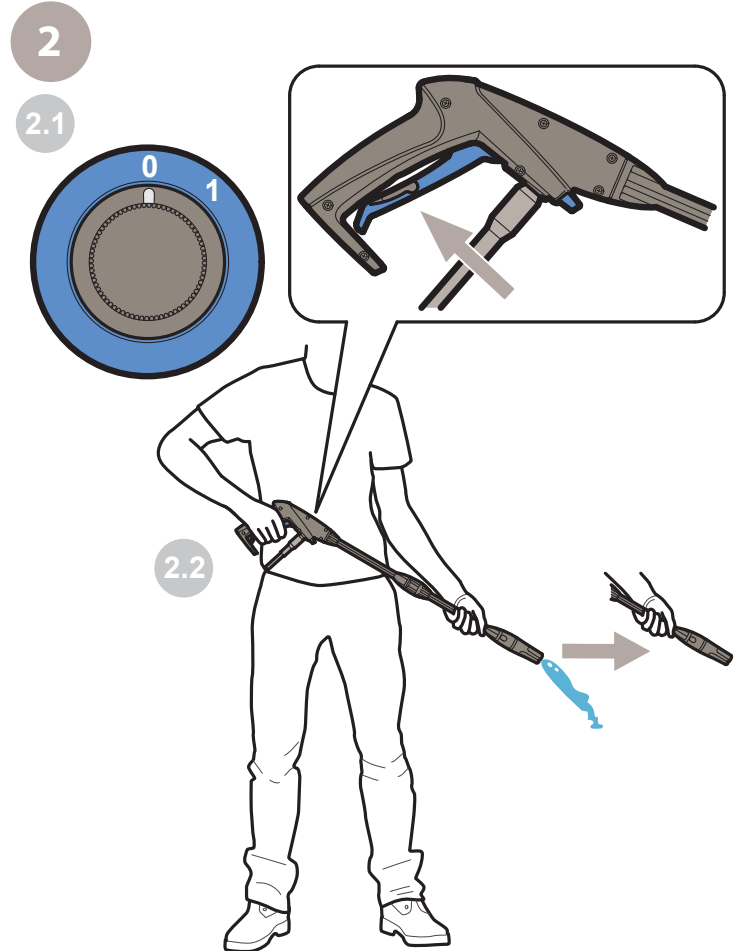
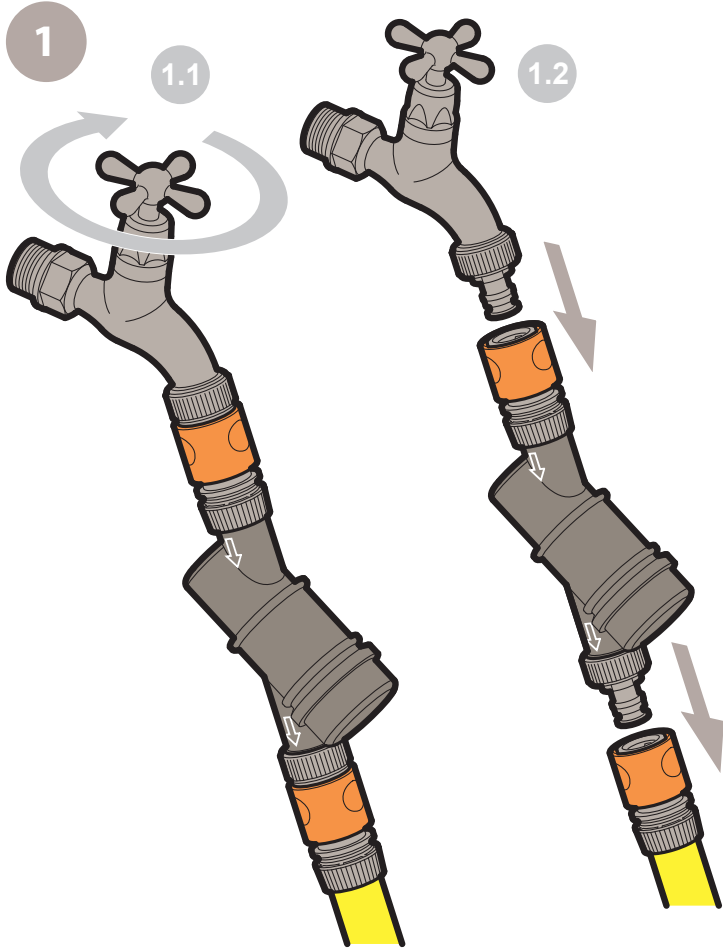
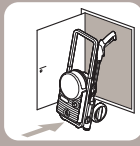

E

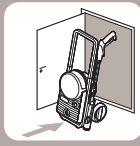

5

5.1

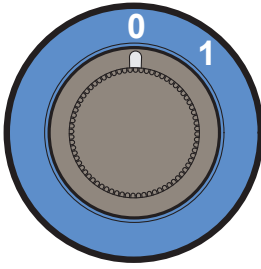

5.2

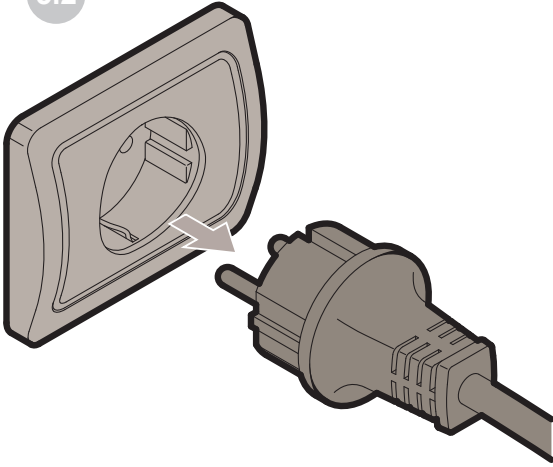

6

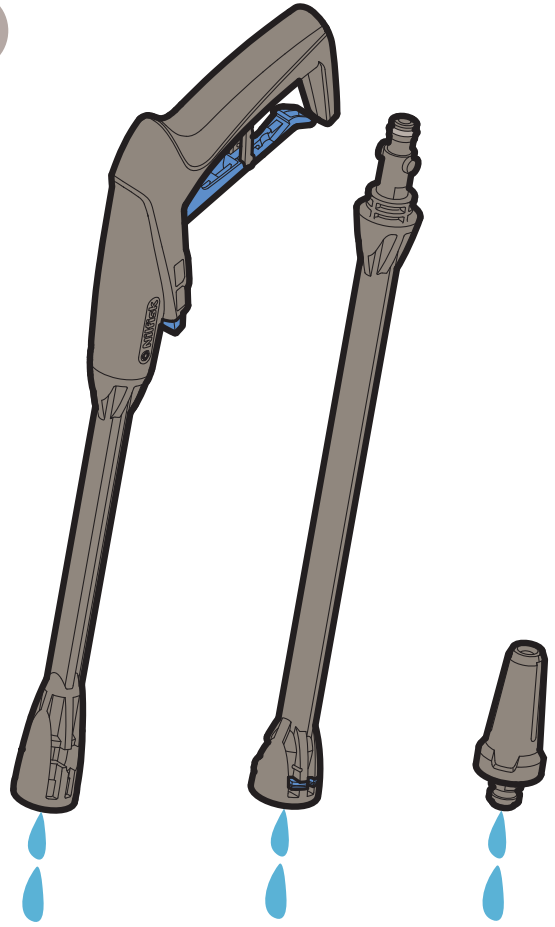

7

7.1

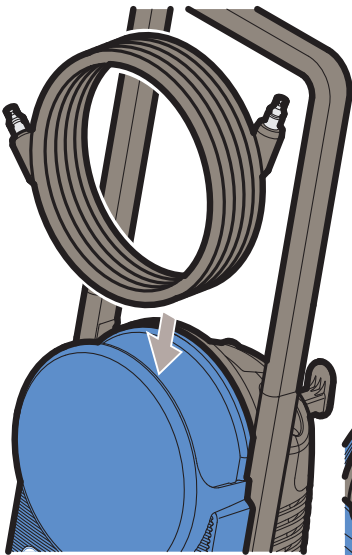

7.2

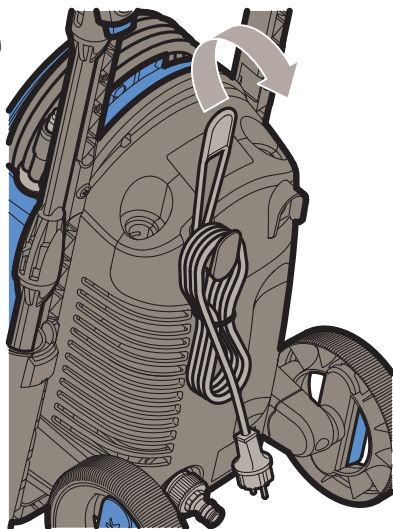

8

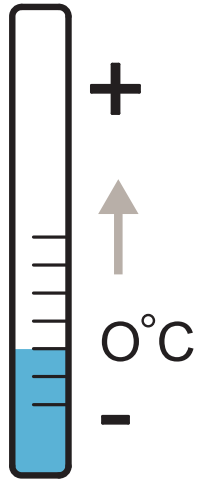
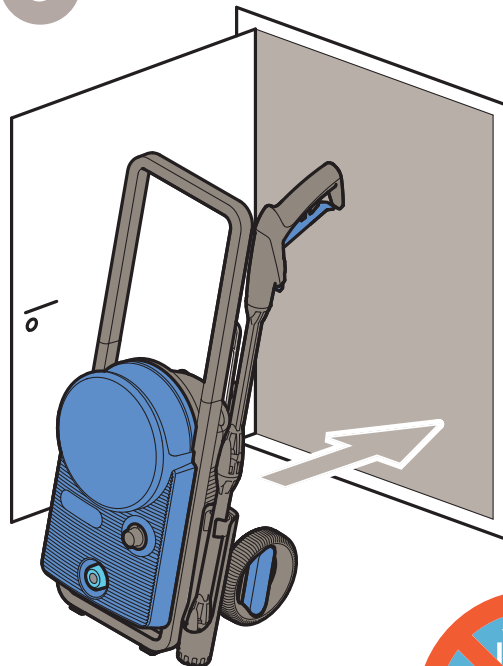

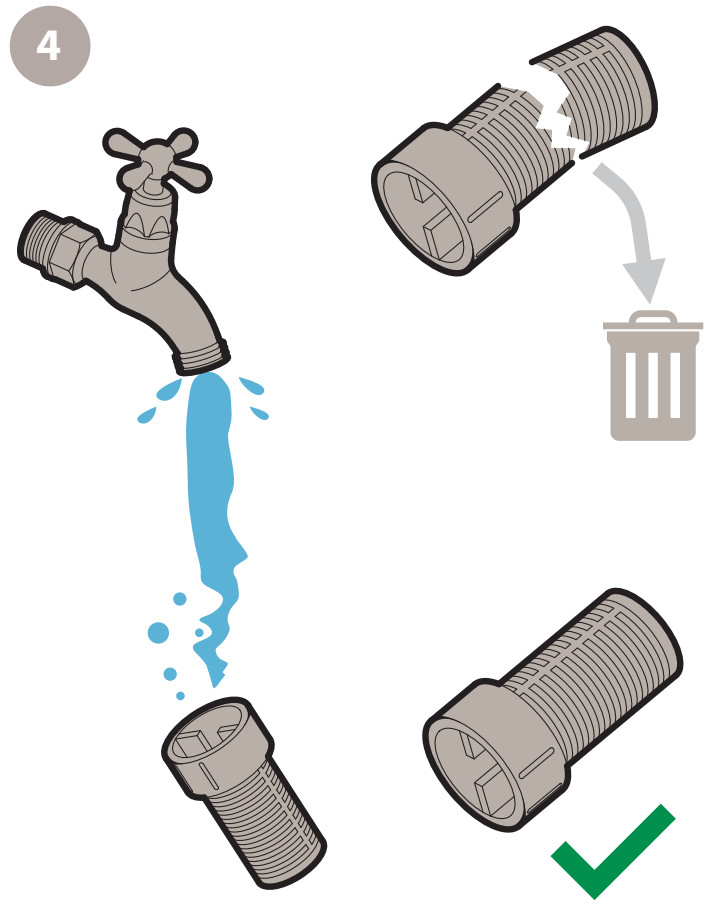
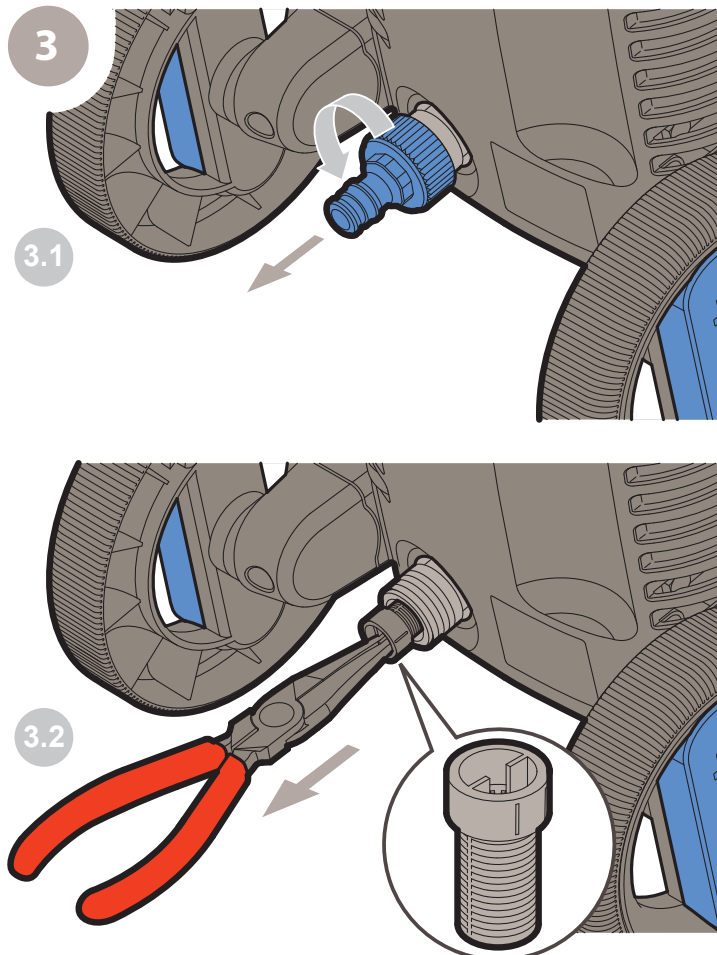
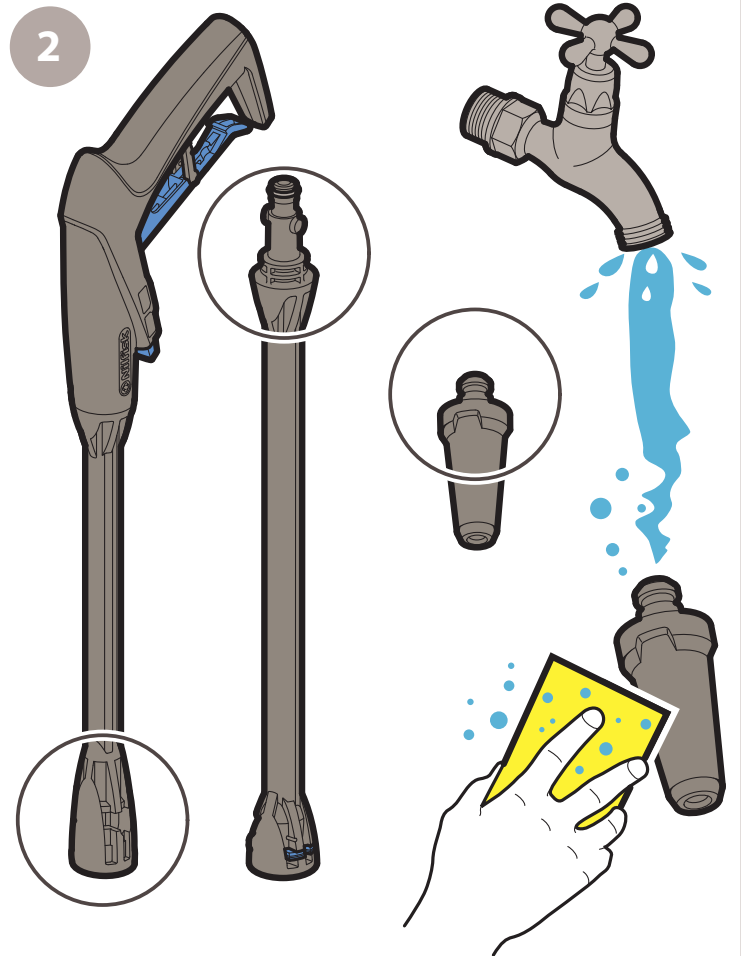
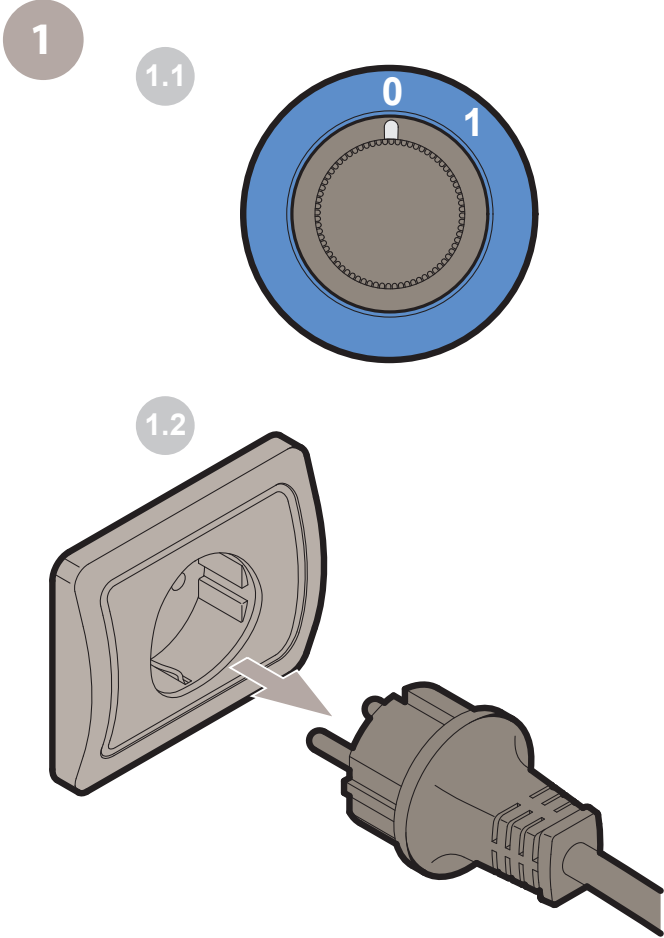



5

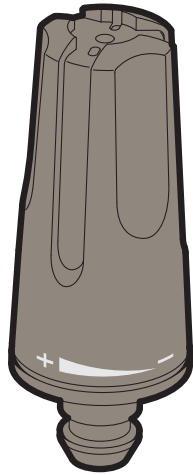
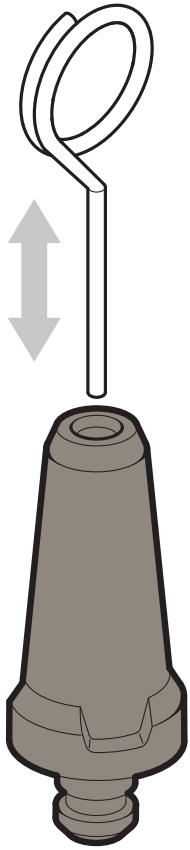

6

