











# ASSEMBLY INSTRUCTIONS

25665 HFR - KINGBED

**X** A HOWARD MILLER COMPANY

NO.	Hardware List		Q'ty
A		Double Thread 5/16 x 100	10
B		Half Moon Washer	10
C		Nut	10
D		Wrench	1
E		Bolt 5/16" * 80mm L	4
F		Lock Washer	4
G		Flat Washer	4
H		Wrench 3/16" Dia * 4-3/4" L	1

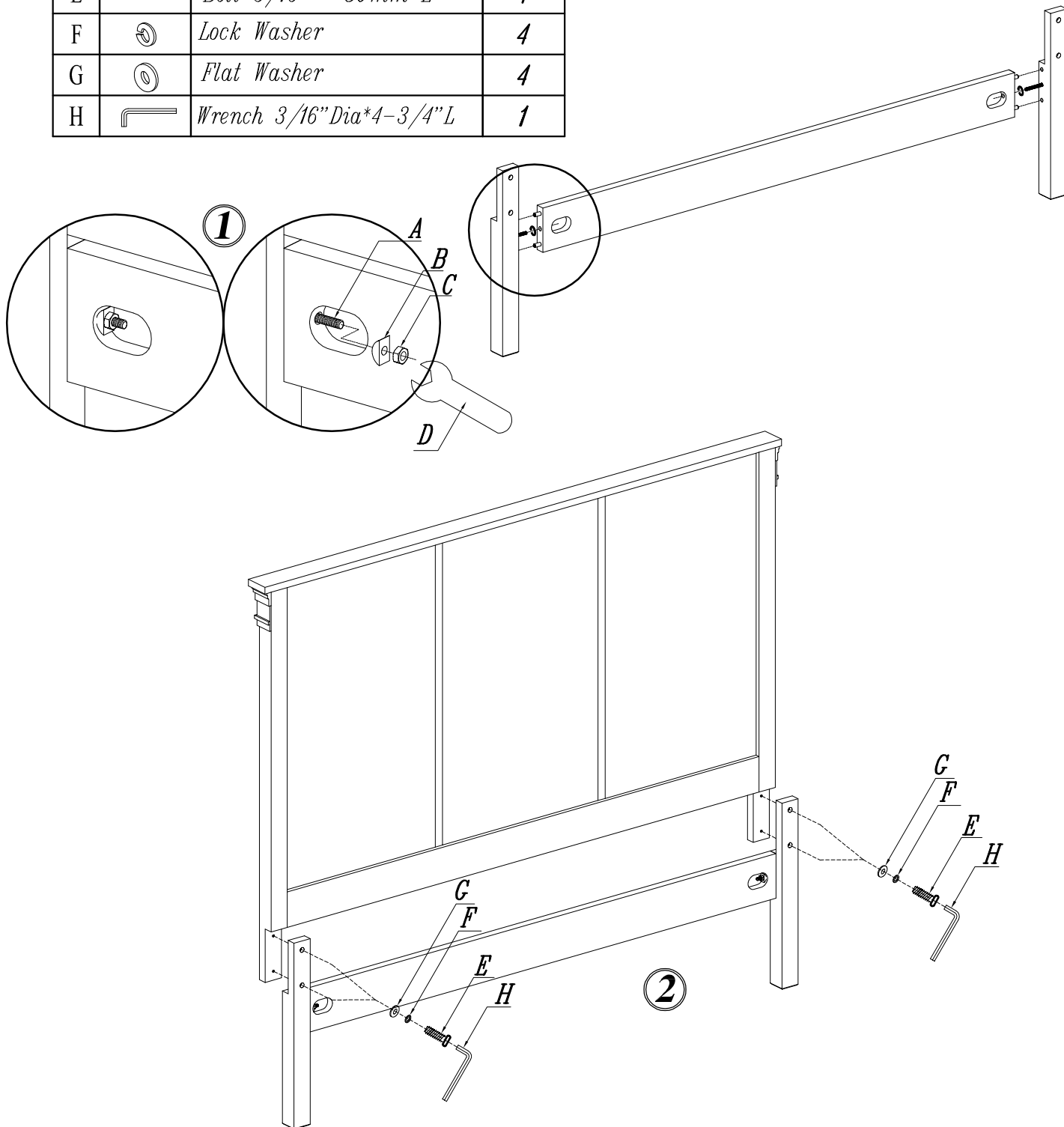

MADE IN INDONESIA

# HEKMAN

A HOWARD MILLER COMPANY

## ASSEMBLY INSTRUCTIONS

25665 HFR-KINGBED

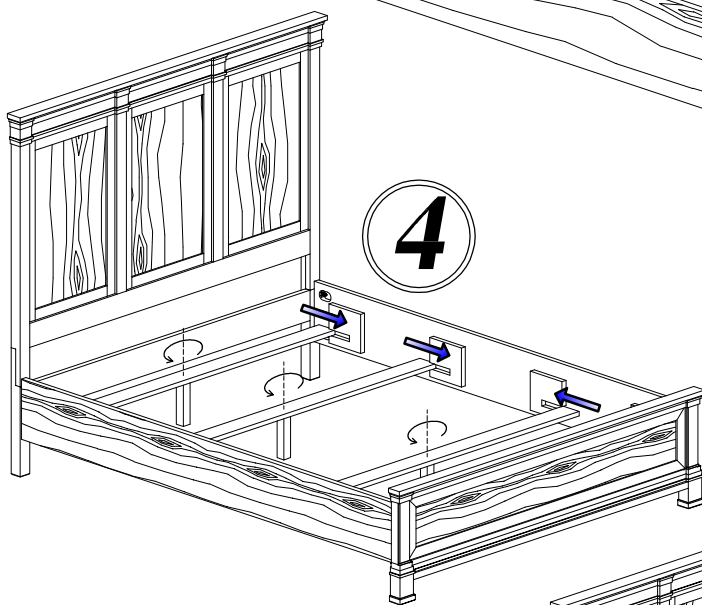
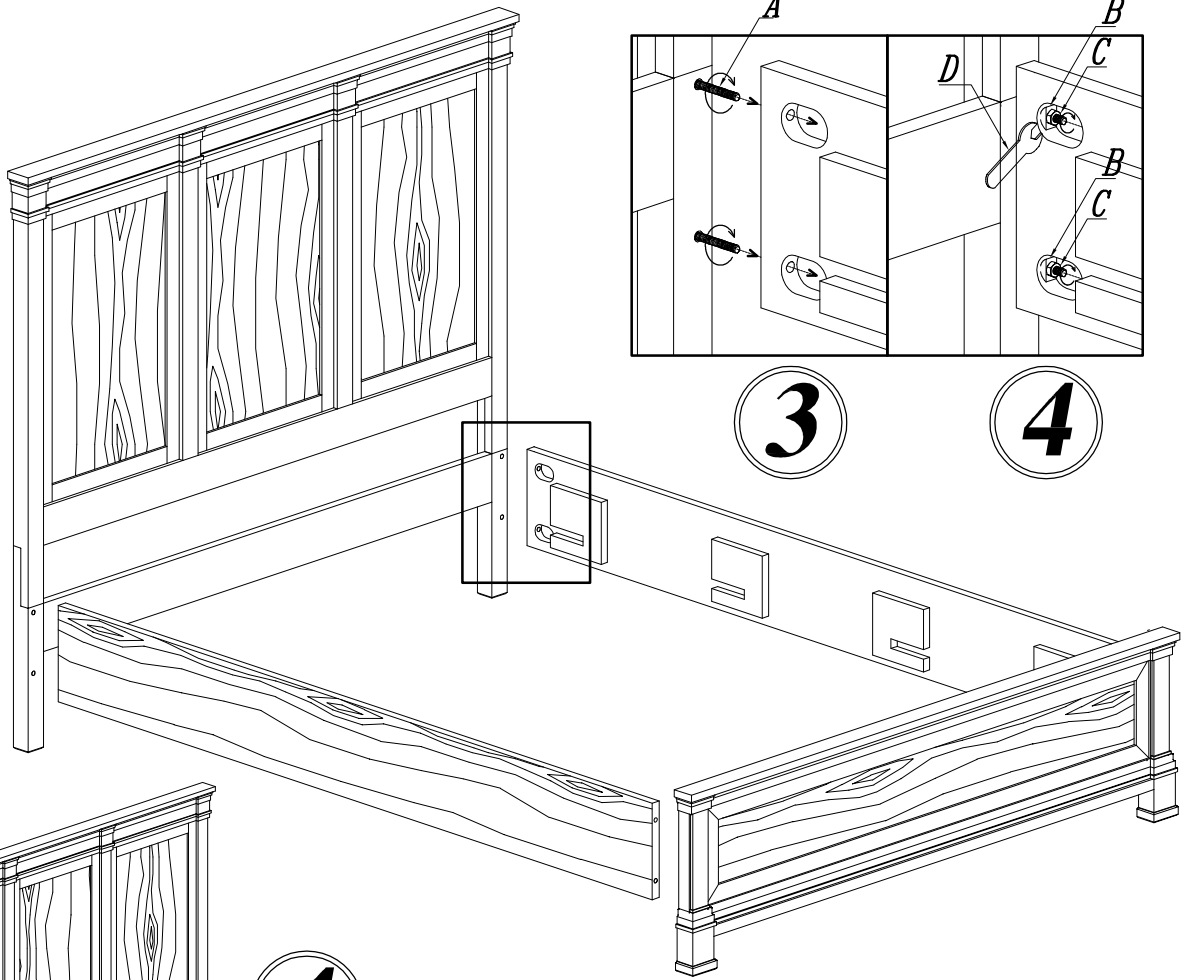

\* SCREW DRIVER  
NOT INCLUDED

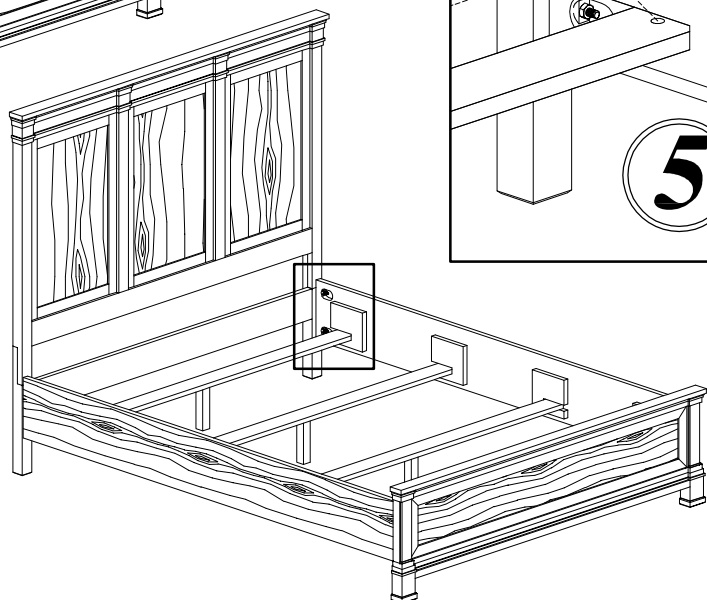
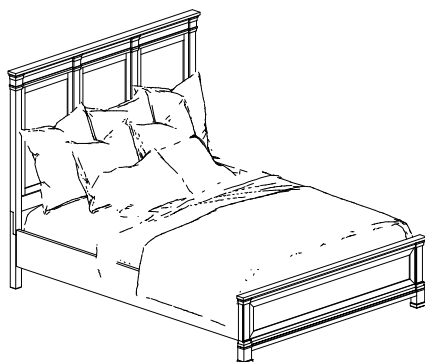
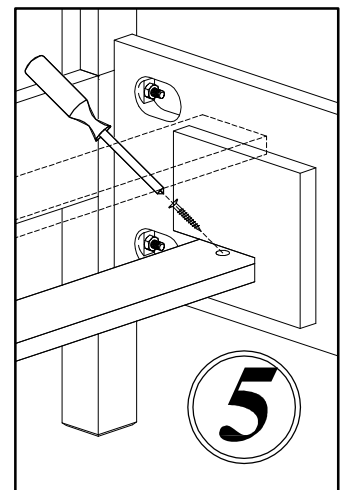

MADE IN INDONESIA