





Specification:

1. Material: Plywood + Birch
2. Finish: See Table
3. Hardware: See Table
4. Slides: USE58-500-15 + USCLIP500-2-4W (2 Set)
5. Hinge: 700.0537.25 + 600.1234.05 (2 Set)
6. Lid Stay (1 PC)
7. The tolerance is +/- 1/8"

Item number	Finish	Deco Hardware	
		Item number	Qty
VN2GAR-30-DW-NT	Dark Walnut	A500-10MB	3
VN2GAR-30-BS-NT	Blue Steel	A500-10MB	3
VN2GAR-30-WH-NT	White	A500-10MB	3
VN2GAR-30-NO-NT	Natural Oak	A500-10MB	3

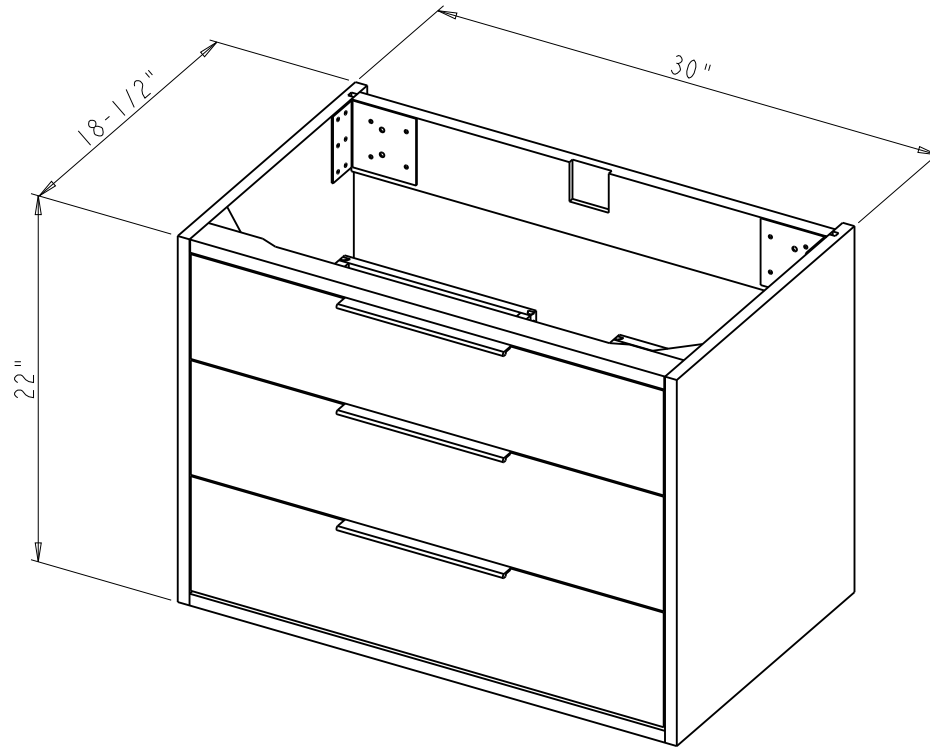
 <p>PROPRIETARY AND CONFIDENTIAL</p> <p>THE INFORMATION CONTAINED IN THIS DRAWING IS THE SOLE PROPERTY OF HARDWARE RESOURCES INC. ANY REPRODUCTION IN PART OR AS A WHOLE WITHOUT THE WRITTEN PERMISSION OF HARDWARE RESOURCES INC. IS PROHIBITED.</p>	ITEM#: VN2GAR-30	MATERIAL:
	FINISH:	WEIGHT: 9
	PROJECTION 	
	TOLERANCE UNLESS OTHERWISE SPECIFIED: X ±0.20 X.X ±0.10 X.XX ±0.05 ANGULAR: ±0.5°	UNITS: DRAWN BY: <i>Hugo.cai</i>
DO NOT SCALE DRAWING	SIZE: SHEET:	APPROVED BY: RELEASE LEVEL: REVISION:



 PROPRIETARY AND CONFIDENTIAL THE INFORMATION CONTAINED IN THIS DRAWING IS THE SOLE PROPERTY OF HARDWARE RESOURCES INC. ANY REPRODUCTION IN PART OR AS A WHOLE WITHOUT THE WRITTEN PERMISSION OF HARDWARE RESOURCES INC. IS PROHIBITED.	ITEM#: VN2GAR - 30		MATERIAL:		
	FINISH:		WEIGHT: 9		
	TOLERANCE UNLESS OTHERWISE SPECIFIED: X ±0.20 X.X ±0.10 X.XX ±0.05 ANGULAR: ±0.5°		UNITS:	DRAWN BY: <i>Hugo.cai</i>	DATE: May - 24 - 23
	DO NOT SCALE DRAWING		SIZE:	APPROVED BY:	DATE:
		SHEET:	RELEASE LEVEL:	REVISION:	



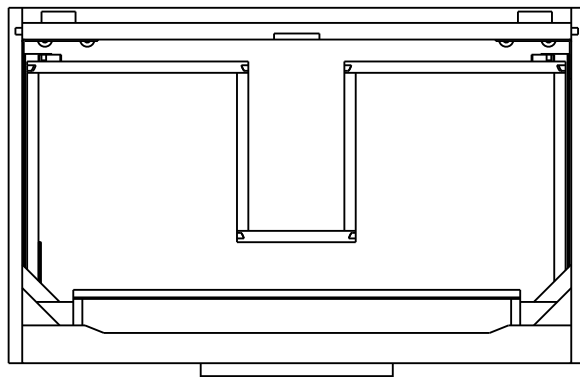
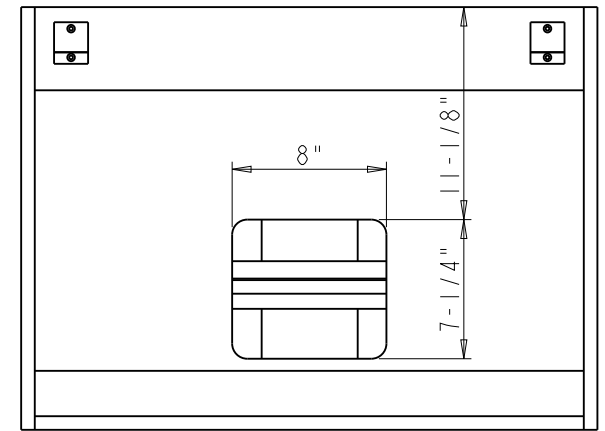
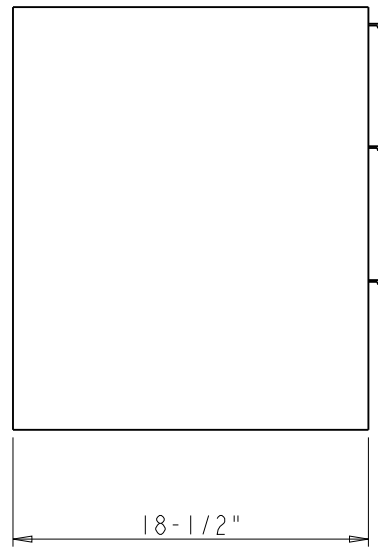
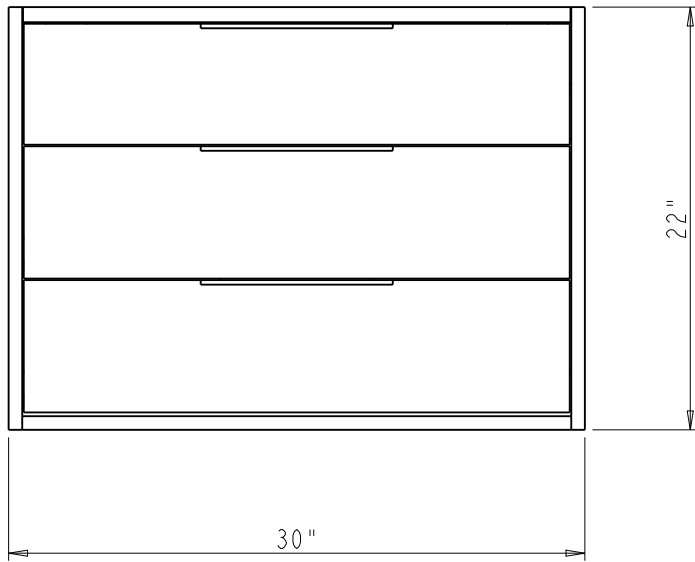

<p>hardware resources</p> <p>PROPRIETARY AND CONFIDENTIAL</p> <p>THE INFORMATION CONTAINED IN THIS DRAWING IS THE SOLE PROPERTY OF HARDWARE RESOURCES INC. ANY REPRODUCTION IN PART OR AS A WHOLE WITHOUT THE WRITTEN PERMISSION OF HARDWARE RESOURCES INC. IS PROHIBITED.</p> <p>DO NOT SCALE DRAWING</p>	ITEM:	VN2GAR - 30	MATERIAL:
	FINISH:		WEIGHT:
	TOLERANCE UNLESS OTHERWISE SPECIFIED:	UNITS:	DRAWN BY:
	SIZE:	APPROVED BY:	DATE:
	SHEET:	RELEASE LEVEL:	REVISION:
			9
			PROJECTION
			<i>Hugo.cai</i> May-24-23