

# evenflo®



EN

## Chase Select™ /LX Child Restraint System

### Owner's Manual

Keep for future use

### Child Requirements

#### 5-point Harness\*

13.6 to 18.1 kg  
(30 to 40 lbs)

89 to 110 cm  
(35 to 43.3 in.)

At least 2 years old

#### Booster\*

18.1 to 45.3 kg  
(40 to 100 lbs)

110 to 145 cm  
(43.3 to 57 in.)

At least 5 years old



\* See page 6 for complete requirements.

Para instrucciones en Español,  
llamar al: 1-800-233-5921

## WARNING:

To reduce the risk of serious injury or death, read this owner's manual prior to installing and using this child restraint.

**More children are killed every year as passengers in car crashes than by any other type of injury.**

To reduce the risk of **SERIOUS INJURY** or **DEATH**, read this owner's manual and your vehicle owner's manual before installing and using this child restraint. Using a child restraint makes a big difference. By properly using this child restraint and following these instructions, the instructions and warning labels on the product, and the instructions that accompany your vehicle, you will greatly reduce the risk of serious injury or death to the child from a crash. Do not be misled by the commonly used term "safety seat"; no restraint system can prevent all injuries in all crashes. Many properly restrained adults and children are injured in motor vehicle crashes, including relatively minor crashes. A properly used child restraint is the best way to minimize injuries to the child and to increase the chances for the child's survival in most crashes.

**U.S. REGULATORY NOTICE**

*This child restraint meets all applicable requirements of Federal Motor Vehicle Safety Standard FMVSS 213.*

**CANADIAN REGULATORY NOTICE  
(Model numbers ending in "C".)**

*This child restraint meets all applicable requirements of Canadian Motor Vehicle Safety Standards CMVSS 213 and 213.2.*

**Symbol Legend**



**Airbag Symbol** – Alerts you to important information about airbag safety.



**LATCH Symbol** – Alerts you to important information about LATCH safety.



**Tether Anchor Symbol** – Alerts you to important information about Tether Anchor safety.



**Aircraft Symbol** – Alerts you to important information about aircraft safety.

# Table of Contents (TOC)

---

## Important Information

Child Restraint Features.....	4
Child Requirements.....	6
Warnings .....	7
LATCH Warnings.....	12
Safe Practices .....	15
Motor Vehicle/Aircraft Usage .....	15
Recall Information for U.S. Customers.....	16
Public Notice for Canadian Customers.....	16

## Using the Internal 5-pt Harness

Installation Checklist .....	18
Installation with Lower Anchor Connector Assembly .....	19
Installation with Seat Belt.....	22
Securing the Child.....	25
Removing the Child.....	27
Positioning the Harness Strap.....	28
Positioning the Buckle Strap .....	30

## Belt-Positioning Booster

Using as a Booster Seat.....	31
Booster Installation Checklist.....	33
Converting into a Booster Seat.....	34
Shoulder belt routing while in booster mode.....	38

## General Information

Leveling the Booster Seat .....	39
Installing the Cup Holders.....	39
Removing Seat Pad.....	40
Securing Your Child Restraint in Aircraft.....	42
Installing Child Restraint in Aircraft.....	42
Care and Cleaning .....	44
Recording Model Information.....	44
Storing Your Instructions.....	45
Proper Disposal of this Child Restraint .....	45
Replacement Parts.....	46
Limited Warranty .....	47

# Child Restraint Features

---

## Front

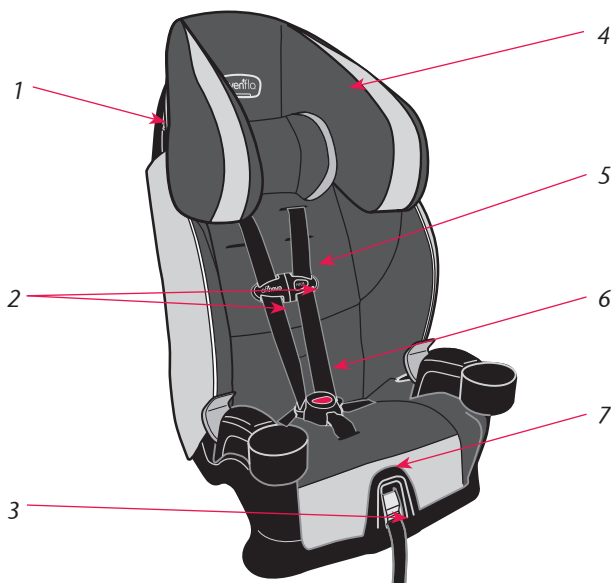

---

## Back

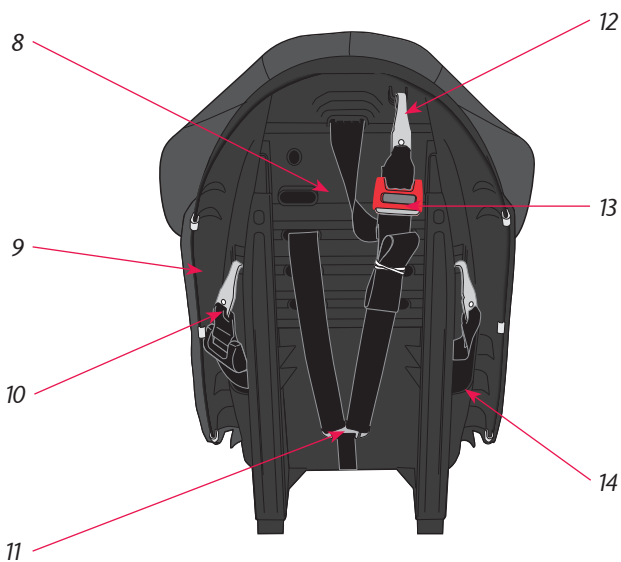

# **Child Restraint Features**

---

## **Description**

- 1.** *Shoulder Belt Guide*
- 2.** *Harness Straps*
- 3.** *Harness Adjust Strap*
- 4.** *Headrest*
- 5.** *Chest Clip*
- 6.** *Buckle*
- 7.** *Harness Release Button*
- 8.** *Model Number & Date of Manufacture*
- 9.** *Instructions*
- 10.** *Lower Anchor Connector Assembly*
- 11.** *Splitter Plate*
- 12.** *Tether Strap and Hook (Shown fastened to storage clip)*
- 13.** *Tether Strap Adjuster*
- 14.** *Vehicle Seat Belt Path*

*\* Not all features are available on all models. Styles may vary.*

## CHILD REQUIREMENTS

### **WARNING**

**Failure to follow these Child Requirements could result in serious injury or death.**

*This child restraint is designed for use by children in **forward-facing** orientation only. To use this child restraint properly, children **MUST** meet the size and age requirements below. In addition, Evenflo recommends consulting with your child's physician before allowing your child to transition from a **rear-facing** to **forward-facing** child restraint.*

*The American Academy of Pediatrics (AAP) recommends keeping children **rear-facing** until they reach the maximum height or weight for their child restraint in **rear-facing** orientation. Additionally, some states' laws require children to be **rear-facing** until age 2. Accordingly, you will see this guidance reflected in the Child Requirements below. Please review any applicable local, state or provincial laws related to child passenger safety before installing and using this child restraint.*

#### **5-point Harness**

- 13.6 to 18.1 kg (30 to 40 lbs)
- 89 to 110 cm (35 to 43.3 in) and tops of the child's ears are at or below the top of the child restraint headrest
- At least 2 years old
- Shoulders are at or below highest harness level

**IMPORTANT:** Once your child **exceeds** any of the size requirements for **5-point harness** use above, you **MUST** discontinue use of this child restraint with its internal harness and begin using it as a belt-positioning booster seat, if possible. If your child **exceeds** any of the size requirements for **5-point harness** use above **and** is less than 5 years old, however, you **MUST** discontinue use of this child restraint.

#### **Belt-Positioning Booster**

- 18.1 – 45.3 kg (40 – 100 lbs)
- 110 to 145 cm (43.3 to 57 in) and tops of the child's ears are at or below the top of the child restraint headrest
- At least 5 years old

**IMPORTANT:** Once your child **exceeds** any of the size requirements above for **belt-positioning** use, you **MUST** discontinue use of this seat. Your child may be ready for use of the vehicle belt system only at this time.

# **⚠️ WARNING** DEATH or SERIOUS INJURY can occur.

## **Air Bag Warnings**

- **DO NOT** use this restraint in the front seat of a vehicle equipped with an air bag. Air bags may cause serious injury or death to children 12 and under. If your vehicle has an air bag, refer to your vehicle owner's manual for child restraint installation.
- If the rear seat of your vehicle is equipped with side air bags, refer to the following information for proper usage.

### **Vehicles built prior to the 2002 model year:**

**DO NOT** use this restraint in a vehicle seating position equipped with a side air bag unless authorized by the vehicle manufacturer.

### **Model year 2002 and newer vehicles:**

Refer to your vehicle owner's manual before placing this restraint in a seating position equipped with a side air bag.

- **DO NOT** place any objects between the restraint and the side air bag, as an expanding air bag may cause the items to strike the child.

***The forward-facing rear seat is the safest place for children 12 and under.***

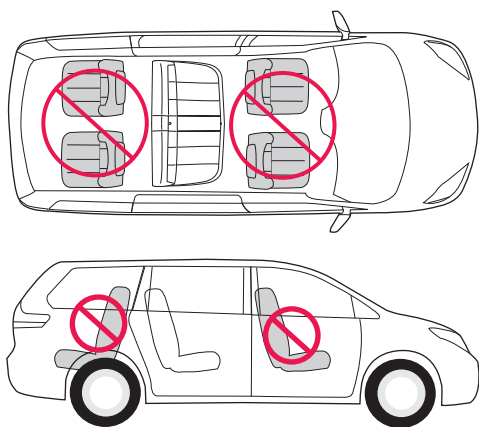

# **⚠ WARNING** DEATH or SERIOUS INJURY can occur.

## **General Warnings**

- Failure to follow the Child Requirements for this child restraint could result in serious injury or death. (See page 6 for Child Requirements).
- Failure to follow these installation instructions and the instructions and warnings on the product can result in the child striking the vehicle's interior during a sudden stop or crash. Serious injury or death may result. These instructions and the instructions in your vehicle owner's manual must be followed carefully. If there is a conflict between the two, the vehicle owner's manual regarding child restraint installation must be followed.
- **NEVER** leave child unattended.
- **DO NOT** use child restraint if it is damaged, broken, or missing parts.
- **DO NOT** use this restraint if it has been involved in a crash. It must be replaced.
- **NEVER** use this child restraint without the headrest installed.
- **NEVER** use this child restraint rear-facing.
- **NEVER** use child restraint without the seat pad.

## **Location Warnings**

- **ALWAYS** read and follow exactly the instructions and warnings that accompany your vehicle and child restraint.
- According to statistics, children are safer when properly restrained in a rear seating position than in the front seating position. Generally, the center rear position is safest and should be used, if available.
- Some child restraints do not fit all vehicles or all seating locations. There are many thousands of combinations of vehicle makes, models, child restraint configurations, seat belt designs, and seat cushion shapes. The easiest way to determine whether the child restraint is suitable for a particular seating position is to check for a tight installation. If the child restraint cannot be properly installed, **DO NOT** use the child restraint. Consult vehicle owner's manual, try a different seating location, or call Evenflo.



# **⚠ WARNING** DEATH or SERIOUS INJURY can occur.

- **ONLY** use this child restraint on forward-facing vehicle seats. **DO NOT** use this restraint with vehicle seats that face the rear or side.
- **ONLY** use this child restraint on vehicle seats with backs that lock into place.

## **Position Warnings**

- If the child exceeds any requirements for 5-point harness, you **MUST** use this child restraint as a booster (p. 31).
- Adjust, or remove, the **vehicle** headrest, in the seat where the child restraint is to be fastened, so that the back of the child restraint rests against the vehicle seat back.
- The headrest on the vehicle seat in front of the child should be put in its lowest position. The vehicle seat back that the child faces must be fully padded and free of any hard objects.

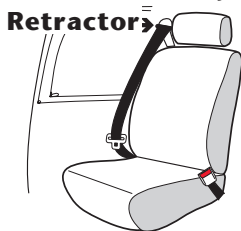

## **Seat Belt Warnings**

If the vehicle seat belts are not routed and fastened correctly, the child restraint may not protect the child in a crash.

- **ALWAYS** read your vehicle owner's manual to determine what vehicle belts and retractors are used in your vehicle.

Lock your retractors if available in your vehicle.

- **DO NOT** use this child restraint if it moves more than 2.5 cm (1 in.) forward or side-to-side at the vehicle belt path. Serious injury or death may result from poor installation. If you cannot tightly secure the child restraint, try again or move it to another location.





- **DO NOT** use this child restraint in a vehicle with door-mounted seat belts.



- **DO NOT** use this child restraint in a vehicle with seat belts that automatically move along the vehicle frame when the door is opened. These seat belts will not hold a child restraint properly.

# **⚠ WARNING** DEATH or SERIOUS INJURY can occur.

## ***Seat Belt Warnings***

- **DO NOT** use this child restraint in a vehicle equipped with lap belts that only lock during a sudden stop or crash (Emergency Locking Retractor – ELR). You must use a seating location with a lap/shoulder belt or a locking lap belt. Check your vehicle owner’s manual to see if you have lap belts with ELRs. 
- **DO NOT** use on vehicle seats when both portions of the vehicle belts are positioned forward of the seat crease. 
- **DO NOT** use with lap/shoulder belts with two retractors. If the vehicle seat belts are not routed and fastened correctly, the child restraint may not protect the child in a crash. 
- **DO NOT** allow the seat belt release button to touch the child restraint. Accidental contact may cause the seat belt to release. If necessary, turn the seat belt release button away from the child restraint or move the child restraint to a different location.
- Failure to adjust the harness or vehicle seat belts snugly around the child may result in the child striking the vehicle’s interior during a sudden stop or crash. Serious injury or death may occur.

## ***For Booster Use Only***

- **WARNING!** Use only the vehicle’s lap and shoulder belt system when restraining the child in this booster seat. **Never use a booster with only a lap belt**, as this could cause serious injuries.
- The shoulder belt **MUST** be threaded properly (p.38).
- **DO NOT** use this booster seat if the child’s ears are above the back of the booster seat headrest.
- The shoulder belt **MUST NOT** cross the child’s neck or fall off the child’s shoulder. If you cannot adjust the shoulder belt to properly lay midway between the child’s shoulder and neck **AND** at or above the shoulder, try another seating location or do not use the booster seat.

# **⚠ WARNING** DEATH or SERIOUS INJURY can occur.

## ***Seat Belt Warnings***

If you have any of these types of vehicle belt systems listed, these are SAFE to use to install your child restraint in the vehicle. Review vehicle owner's manual for specific instructions on child restraint installation.

**LATCH** can be used IN PLACE OF these vehicle belt types. Refer to the weight limits on **LATCH** use on page 19. Refer to your vehicle owner's manual for **LATCH** locations.

---

### ***Lap Belt with Locking Latch Plate***

Once buckled, the vehicle belt is tightened by pulling on the free end of the strap until the belt is tight.



---

### ***Lap Belt with Automatic Locking Retractor (ALR)***

The automatic locking retractor does not allow the lap belt to get longer once it is buckled. The vehicle belt is tightened by feeding seat belt webbing into retractor.

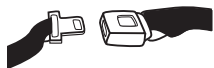

---

### ***Lap/Shoulder Belt with Locking Latch Plate***

The lap portion of this belt does not loosen once the belt is buckled.

The vehicle belt is tightened by pulling up hard on shoulder belt and feeding the extra webbing into the retractor.

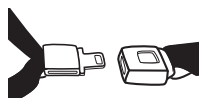

---

### ***Lap/Shoulder Belt with Sliding Latch Plate with Locking Retractor***

The latch plate slides freely along the lap/shoulder belt. Vehicle belts with sliding latch plates are typically locked at the shoulder belt retractor by buckling the belt and pulling all of the webbing out slowly to switch the retractor.

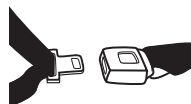

Check vehicle owner's manual for specific instructions. The vehicle belt is tightened after switching the retractor by pulling up on shoulder belt and feeding the webbing into the retractor.

# **⚠ WARNING** DEATH or SERIOUS INJURY can occur.

## **LATCH/UAS Warnings**

*For 5-point Harness Use Only*

What is **LATCH**?

**LATCH** is an acronym for (**L**ower **A**nchors and **T**ethers for **C**hildren) and refers to a pair of fixed Lower Anchors (or bars) and a Top Tether anchor that are built into your vehicle, in vehicles built after September 1, 2002.

The lower **LATCH** anchors are located in the crease, or bight, between the vehicle seat back and seat cushion, and if not visible, will typically be indicated by the  symbol. Top tether anchors are located in various places behind the rear vehicle seat.

**Vehicle Top Tether Anchor Points**

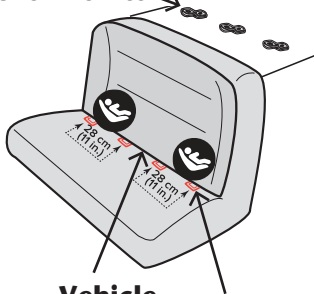

**Vehicle Seat Crease**

**Vehicle Lower Anchors**

### **Center installation in a non-standard LATCH position:**

Center installation of this child restraint is permitted using inner Lower Anchor Bars from the outside seating positions if:

1. your vehicle manual allows such installation; and
2. the inner Lower Anchor Bars from the outside seating positions are 28 - 51 cm (11 - 20 in.) apart.

**LATCH** typically offers an easier and more consistent installation. However, this child restraint can be safely installed using either **LATCH** or vehicle belts and meets the requirements of Federal Safety Standard FMVSS 213 with either installation method. Either method is safe for your child when installed correctly. When using either method, it is best practice to **ALWAYS USE** tether when installing in the forward-facing position.

**DO NOT** install this child restraint with **LATCH** and the vehicle's seat belts at the same time. Your vehicle owner's manual may refer to this system as **ISOFIX**, **Universal Anchorage System (UAS)**, or **Lower Universal Anchorage System**.

The **LATCH** system is intended to be used **ONLY** as described in these instructions. Serious injury or death may result from misuse. Refer to your vehicle Owner's Manual for lower anchor bar positions in your vehicle.

**⚠ WARNING** **DEATH or SERIOUS INJURY can occur.**  
**LATCH/UAS Warnings**

- In addition to these instructions, read and follow your vehicle owner's manual regarding installation of the child restraint and LATCH. If there is a discrepancy, follow your vehicle owner's manual.
- **ONLY** use for securing child restraint to vehicle lower anchor bars.
- **NEVER** attach two lower anchor connectors to one vehicle lower anchor bar.
- **NEVER** use the vehicle seat belts when using the lower anchor connector assembly. Using both together can cause slack in a sudden stop or crash.
- When not in use, the lower anchor connector assembly should be securely stored on child restraint. Keep out of reach of children.
- **ALWAYS** be sure that the lower anchor connectors are attached to the vehicle lower anchor bars by pulling hard on the lower anchor connectors. If they are not attached, the lower anchor connector assembly will not secure your child restraint. Serious injury or death may result.
- **DO NOT** use this child restraint if it moves more than 2.5 cm (1 in) side to side or front to back at the belt path on the child restraint. Serious injury or death may result from poor installation. If you cannot tightly secure the child restraint, try again or move it to another location.

# **WARNING** DEATH or SERIOUS INJURY can occur.

## ***Tether Strap Warnings***

- To avoid a strangulation hazard, you **MUST** tightly roll or fold excess or unused tether strap and secure with a rubber band. Attach the tether hook to the storage clip when not in use (p. 4). This will keep an unused tether from hitting someone during a crash.

## ***Additional Warnings***

- In hot or sunny weather, **ALWAYS** check the areas of the child restraint that may contact your child (e.g., buckle, buckle tongues, etc.) for hot areas before placing him/her into the child restraint. The child could be burned. Cover the child restraint with a light colored blanket when you leave the vehicle.
- This child restraint must be securely fastened to the vehicle, **even when unoccupied**, using the vehicle seat belts or lower anchor connectors. An unsecured child restraint may injure someone if a crash occurs.
- **DO NOT** use the cup holders to store cans or hard cups. Only for use with soft cups.
- **DO NOT** place any cups that contain hot liquids in the cup holders.
- **DO NOT** attach additional padding, toys, or other devices not made by Evenflo or described in these instructions for the child restraint. Items not tested with the child restraint could injure the child. Additional pads or pillows may interfere with the function of the harness system, or cause breathing problems if the child's head falls forward, increasing the risk of serious injury or death.
- In cold weather, **DO NOT** dress the child in bulky clothing like snowsuits if the child is riding in a child restraint. Bulky coats/snowsuits make it difficult to properly tighten the harness to the child, which may allow the child to be ejected from the restraint during a crash. If necessary, place a blanket over the harnessed child without interfering with the child restraint harness system.

- **Everyone rides buckled up or the vehicle does not go.** Make no exceptions for adults or children. If someone unbuckles, stop the vehicle. Being firm and consistent from the start will mean fewer discipline problems as children get older. An unrestrained person can be thrown into and injure other passengers.
- **NEVER** try to tend to a crying baby's needs while driving. **NEVER** take a baby out of a child restraint for comforting while the vehicle is moving.
- **DO NOT** allow a child in a vehicle to have objects such as lollipops or ice cream on a stick. The object can injure the child if the vehicle swerves or hits a bump.
- **DO NOT** feed an infant who is riding in a child restraint.
- Put sharp or heavy items in the trunk. Anything loose can be deadly in a crash.

### **Motor Vehicle/Aircraft Usage**

---

**When used with the 5-point harness system and properly installed pursuant to these instructions**, this restraint is certified for use only in passenger and multi-purpose passenger motor vehicles, buses, and trucks equipped with either lap belts only or lap/shoulder belt systems and in aircraft.



Refer to pages 42 to 43 for instructions on installing your child restraint in aircraft.

**When used without the 5-point harness system (in booster mode) and properly installed pursuant to these instructions**, this restraint is certified for use only in passenger and multi-purpose passenger motor vehicles, buses, and trucks equipped with lap/shoulder belt systems only. In booster mode, this seat is **NOT** certified for aircraft use. A belt-positioning booster requires the use of a lap/shoulder belt system, which is not available on aircraft.

## **Recall Information for U.S. Customers**

- Child restraints could be recalled for safety reasons.  
You must register this restraint to be reached in a recall. Send your name, address, e-mail address (optional), phone number (optional), and the restraint's model number and manufacturing date to:

**Evenflo Company, Inc.**  
**1801 Commerce Dr.**  
**Piqua, OH 45356**  
or call 1-800-233-5921.

You may also register online at  
**[www.evenflo.com/registercarseat](http://www.evenflo.com/registercarseat)**

- For recall information, call the U.S. Government's Vehicle Safety Hotline at 1-888-327-4236 (TTY:1-800-424-9153), or go to **[www.NHTSA.gov](http://www.NHTSA.gov)**

## **Public Notice for Canadian Customers**

- To register your child restraint, return your registration card, call 1-937-773-3971, or register online at:  
**[www.evenflo.com/registercarseatcanada](http://www.evenflo.com/registercarseatcanada)**
- For recall information, call Transport Canada at 1-800-333-0510 (1-613-993-9851 in Ottawa region) or Evenflo at 1-937-773-3971.



# Using the Internal 5-pt Harness

## Child Requirements

- **Weight:** 13.6 - 18.1 kg (30 - 40 lbs)
- **Height:** 89-110 cm (35-43.3 in) and tops of the child's ears are at or below the top of the child restraint headrest
- **Age:** At least 2 years old
- Shoulders are at or below highest harness level

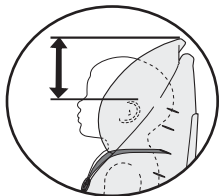

## IMPORTANT

When installing this child restraint with LATCH or the vehicle seat belt, always use the top anchorage (tether) strap.

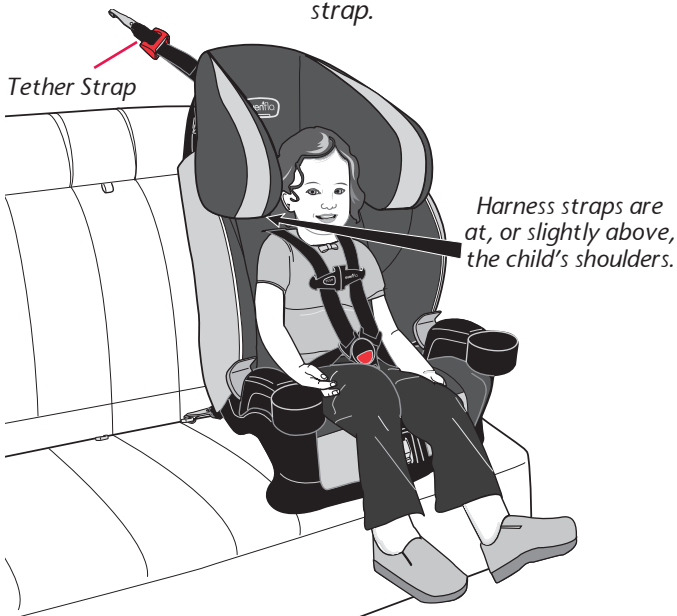

**IMPORTANT:** Once your child **exceeds** any of the size requirements for **5-point harness** use above, you **MUST** discontinue use of this child restraint with its internal harness and begin using it as a belt-positioning booster seat, if possible. If your child **exceeds** any of the size requirements for **5-point harness** use above **and** is less than 5 years old, however, you **MUST** discontinue use of this child restraint.

## **Installation Checklist**

### **1. Secure child restraint to the vehicle seat.**

- ✓ Locking clip is installed, if necessary (p. 23).
- ✓ Child restraint is securely installed with lower anchor connector assembly through belt path (p. 19) **OR** Child restraint is securely installed with vehicle seat belt through belt path (p. 22)
- ✓ Tether strap is attached and tightened (p. 21 and 24).

### **2. Place the child in the child restraint.**

- ✓ The child's back and bottom are flat against the back and bottom surfaces of the child restraint.
- ✓ The top of the child's ears **MUST** be at or below the top of the child restraint headrest.

### **3. Make necessary adjustments.**

- ✓ Harness straps are snug against the child's shoulders, with no slack (p. 26).
- ✓ Straps must be positioned at the child's shoulder level or in the closest position slightly above. (p. 29)
- ✓ Crotch strap is properly positioned (p. 30).

### **4. Fasten both buckle tongues.** Refer to page 25.

### **5. Position and connect chest clip.**

- ✓ Chest clip **MUST** be at armpit level (p. 26).

### **6. Check your work.**

- ✓ To properly protect the child, the child restraint **MUST NOT** move more than 2.5 cm (1 in) from side-to-side or from front-to-back at the belt path.



*To make installation easier, watch the installation video of this child restraint at [www.evenflo.com](http://www.evenflo.com).*



## Installation with Lower Anchor Connector Assembly

### **⚠ WARNING** DEATH or SERIOUS INJURY can occur.

- To avoid a strangulation hazard, you **MUST** store the unused lower anchor connector assembly, with all slack removed, in storage area on the back of the seat. Roll or fold excess lower anchor connector strap and secure with a rubber band to prevent serious injury to vehicle occupants.

The lower anchor connector assembly that comes with your child restraint is shown below.

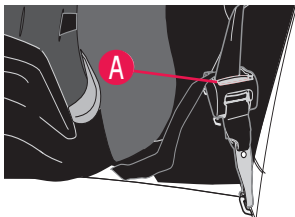

Press the adjuster release button **A** to loosen.

**IMPORTANT:** If you are using the lower anchor connector assembly to secure the child restraint, **DO NOT** use the vehicle seat belt.

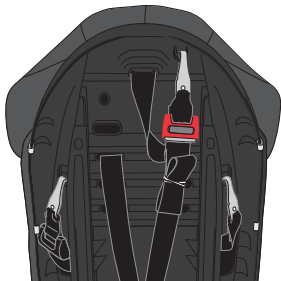

**1. Disconnect tether hook and lower anchor connectors from the back of the child restraint.**

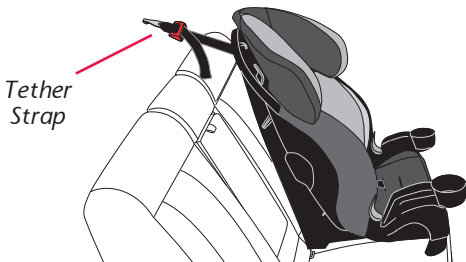

**2. Place the child restraint in position.**

Set child restraint on vehicle seat in forward-facing position. Lay the tether strap over the back of the vehicle seat.

## Installation with Lower Anchor Connector Assembly



### 3. Attach lower anchor connectors.

Attach a lower anchor connector onto each lower anchor bar.

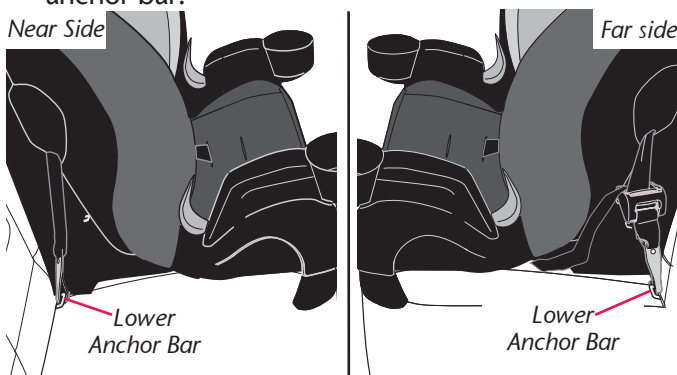

**IMPORTANT:** Make sure both lower anchor connectors are facing upward and the lower anchor connector straps are not twisted.

### Center installation in a non-standard LATCH position:

Center installation of this child restraint is permitted using inner Lower Anchor Bars from the outside seating positions if:

1. your vehicle manual allows such installation; and
2. the inner Lower Anchor Bars from the outside seating positions are 28-51 cm (11-20 in.) apart.

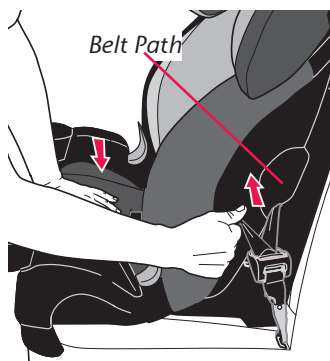

### 4. Secure the child restraint.

Using your full weight, push the child restraint firmly into the vehicle seat while pulling up on the lower anchor connector assembly strap to tighten.

**IMPORTANT:** To properly protect the child, the child restraint **MUST NOT** move more than 2.5 cm (1 in) from side-to-side or from front-to-back **at the belt path**. If you cannot tightly secure the child restraint, try again or move it to another location.



## Installation with Lower Anchor Connector Assembly

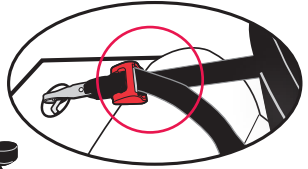
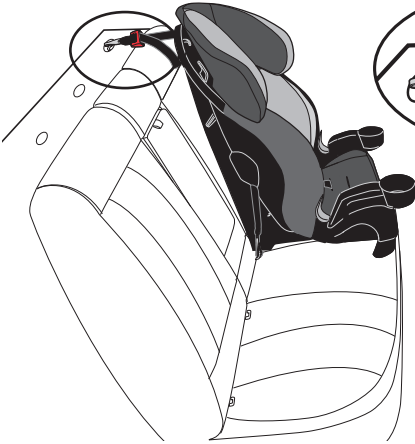

**NOTE:** Press the adjuster release button to loosen.

### 5. Connect and tighten tether strap.

Connect the tether hook to the anchor behind the vehicle seat, as shown. (Please consult your vehicle owner's manual, as tether anchor locations may vary.) Pull the strap and tighten the tether securely.

**IMPORTANT:** If your tether strap is too short to reach from your child restraint to your vehicle tether anchor, you will need a Tether Extender. Please call ParentLink at 1-800-233-5921 (U.S.) or 1-937-773-3971 (Canada).

## Installation with Seat Belt

**IMPORTANT:** If you are using the vehicle seat belt to secure the child restraint, **DO NOT** use the lower anchor connector assembly.



- 1. Disconnect tether hook from the back of the child restraint.**

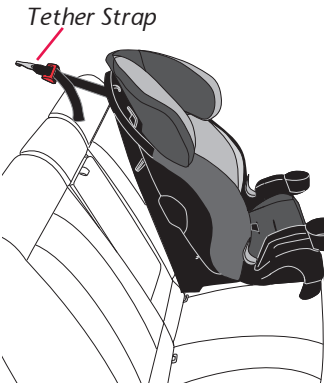

- 2. Place the child restraint in position.**

Set child restraint on vehicle seat in forward-facing position. Lay the tether strap over the back of the vehicle seat.

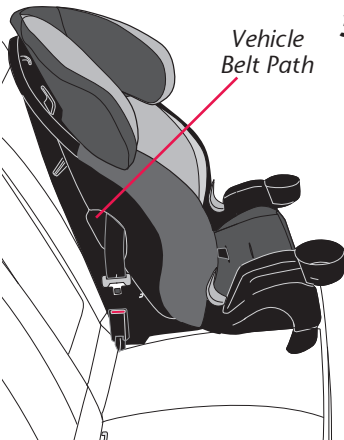

- 3. Route vehicle seat belt through belt path and buckle it, as shown.**

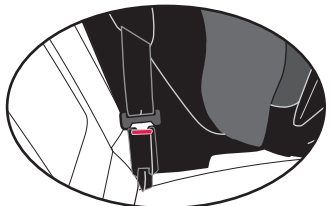

**NOTE:** Lift the restraint's seat pad away for easier access.

## Installation with Seat Belt

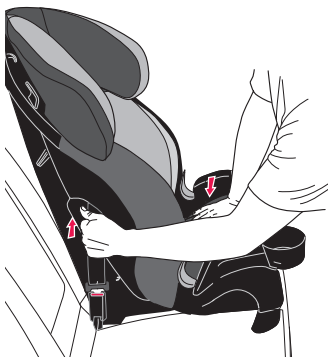

- 4. Remove all slack from the seat belt.** Push downward on child restraint while tightening seat belt to remove excess slack.

Using with the 5-pt Harness

### **5. Install Locking Clip (not included), if necessary.**

If your vehicle is **model year 1996 or newer**, it likely has a vehicle belt system that can be locked when tightened, and will not require use of a Locking Clip.

If your vehicle was built **prior to model year 1996**, and has a lap/shoulder belt that is equipped with an emergency locking retractor (ELR) AND sliding latch plate, you **MUST** use a Locking Clip. Check your vehicle owner's manual to identify which vehicle belt system is in your vehicle.

### **! WARNING DEATH or SERIOUS INJURY can occur.**

- **Consult your vehicle owner's manual before installing a locking clip.**
- **DO NOT** use a Locking Clip in booster mode.
- Remove Locking Clip from vehicle seat belt when not used with a child restraint, or the vehicle seat belt will not properly restrain an adult or child.

If your vehicle requires a Locking Clip, please call ParentLink at 1-800-233-5921 (U.S.), 1-937-773-3971 (Canada), to obtain a Locking Clip and instructions.

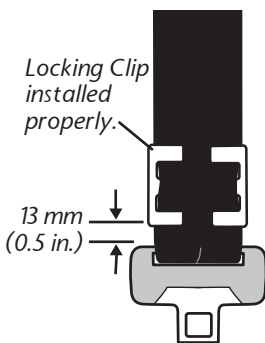

## Installation with Seat Belt

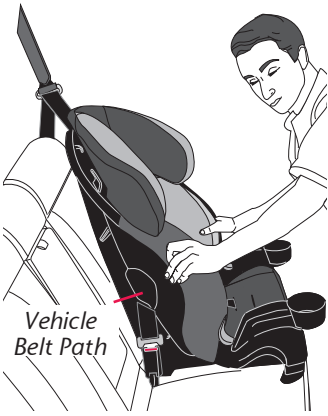

### 6. Ensure child restraint is secure.

Try to move the child restraint in all directions.

**IMPORTANT:** To properly protect the child, the child restraint **MUST NOT** move more than 2.5 cm (1 in) from side-to-side or from front-to-back **at the vehicle belt path**. If you cannot tightly secure the child restraint, try again or move it to another location.

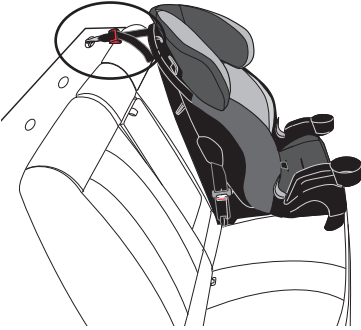

**NOTE:** Press the adjuster release button to loosen.

### 7. Connect and tighten tether strap.

Connect the tether hook to the anchor behind the vehicle seat, as shown. (Please consult your vehicle owner's manual, as tether anchor locations may vary.) Pull the strap and tighten the tether securely.

**IMPORTANT:** If your tether strap is too short to reach from your child restraint to your vehicle tether anchor, you will need a Tether Extender. Please call ParentLink at 1-800-233-5921 (U.S.) or 1-937-773-3971 (Canada).



# Securing the Child

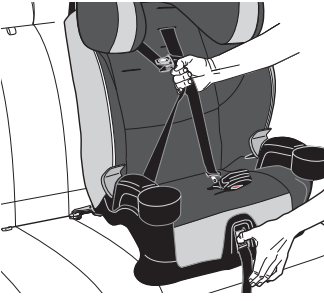

## 1. Loosen harness.

Press the harness release button on the front of the seat while pulling the harness straps.

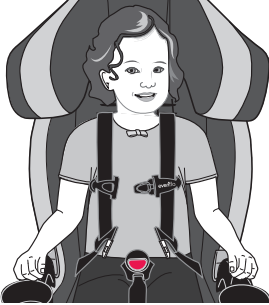

## 2. Position harness straps.

Unfasten chest clip and place the child in the child restraint. Bring each harness strap over the child's shoulders.

### IMPORTANT:

- The child's back and bottom should be flat against the restraint. If there is a gap, the child will not be comfortable.

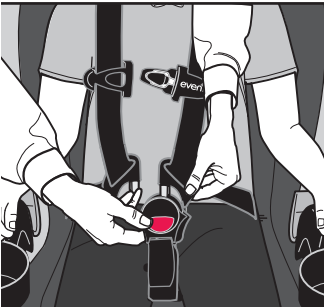

## 3. Buckle the harness.

Insert both buckle tongues into the buckle. **NOTE:** Pull up on the harness straps to ensure that the buckle tongues are fastened securely.

## Securing the Child

---

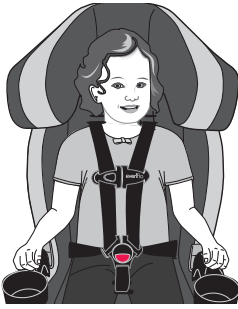

### 4. **Fasten and adjust chest clip.**

Snap the two halves of the chest clip together, as shown, and slide to armpit level.



### 5. **Tighten harness.**

Pull the harness adjuster strap to tighten the harness. **NOTE:** Check the harness straps near the shoulders for slack. You should **NOT** be able to pinch the harness (see illustration). Adjust as needed.

**IMPORTANT:** A snug strap should not allow any slack. It lies in a relatively straight line without sagging. It does not press on the child's flesh or push the child's body into an unnatural position.

## Removing the Child



### 1. Loosen harness straps.

Press the harness release button on the front of the seat while pulling the harness strap outward behind the fastened chest clip.



### 2. Disconnect chest clip.

Push the release button and pull the chest clip apart.

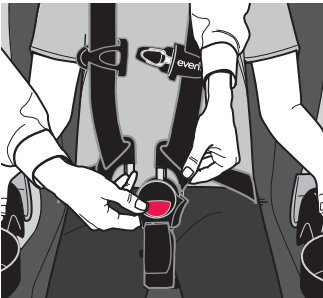

### 3. Unbuckle harness.

Press the red button on the buckle and release both buckle tongues. You may now remove the child.

## ***Positioning the Harness Strap***

---

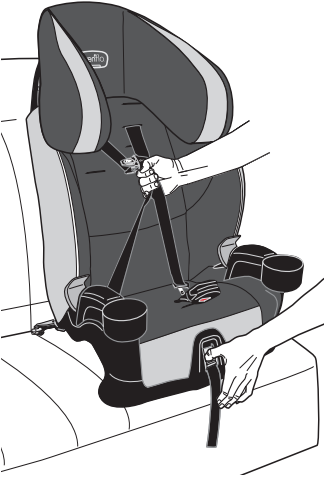

### ***1. Loosen harness straps.***

Press the harness release button on the front of the seat while pulling the harness straps.

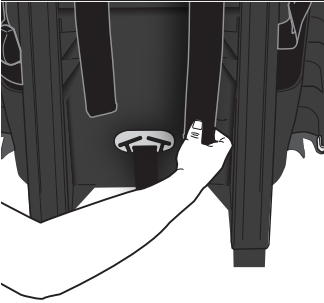

### ***2. Remove both Harness Straps from the Splitter Plate.***

## Positioning the Harness Strap

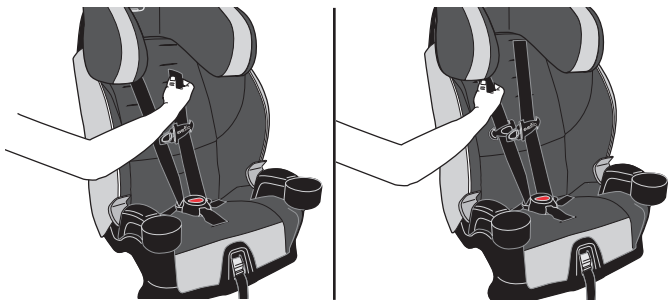

Using with the 5-pt Harness

### 3. Move harness strap.

Remove both harness straps from the slots and feed them into the new slot, as shown. Pull the harness strap to the back of the child restraint.

**NOTE:** Straps must be positioned at the child's shoulder level or in the closest position slightly above.

**IMPORTANT:** When inserting harness straps through the slots in the seat pad, make sure you route them correctly through their corresponding slots in the seat shell.

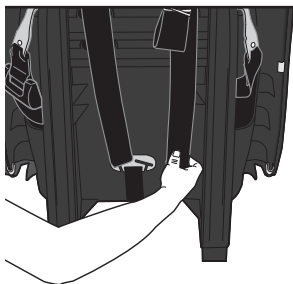

### 4. Attach Harness Straps to Splitter Plate.

Attach the loop at the end of each harness strap onto the splitter plate.

**IMPORTANT:** Make sure both harness straps are installed **completely** on the splitter plate. When properly positioned, the straps will appear bunched together and will not lie flat (see illustration).



## Positioning the Buckle Strap

---

As your child grows, you will need to change the buckle strap position so that it is in the slot closest to your child. The buckle strap should **ALWAYS** be as close as possible to, but **NEVER** under, the child's bottom.



### 1. Remove Buckle Strap.

Loosen the harness straps and move them out of the way. Push the anchor up through the slot to the top of the seat.



### 2. Insert Buckle Strap into new slot.

Insert the buckle strap anchor into the slot that is the closest to the child, but **NEVER** under, the child's bottom. Pull the buckle strap to make sure it is secure.

**IMPORTANT:** When inserting harness straps through the slots in the seat pad, make sure you route them correctly through their corresponding slots in the seat shell.

# Using as a Booster Seat

## Child Requirements

- **Weight:** 18.1 – 45.3 kg (40 – 100 lbs)
- **Height:** 110-145 cm (43.3 to 57 in) and tops of the child's ears are at or below the top of the child restraint headrest
- **Age:** At least 5 years old

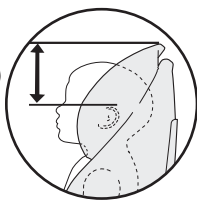

The shoulder belt **MUST** be routed properly. See Page 38.

The shoulder belt **MUST** cross midway between child's shoulder and neck.

The lap belt is stretched low and snug across the child's hips.

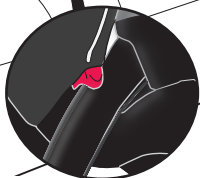

The lap and shoulder belts **MUST** pass beneath the lower belt guide and fasten into the buckle (Canadian models only).



**IMPORTANT:** Once your child **exceeds** any of the size requirements above for **belt-positioning** use, you **MUST** discontinue use of this seat. Your child may be ready for use of the vehicle belt system only at this time.

### Important

Always secure the booster seat with the lower anchor connectors or vehicle seat belt when not occupied. An unsecured booster seat can fly into and injure other occupants in the event of a crash.

# When to Put Your Child in a Booster Seat

Booster seats raise the child up and help to position the vehicle lap and shoulder belt correctly. When the child is **properly restrained** in a booster seat, their risk of injury in all types of crashes is reduced, as the lap and shoulder belt provides excellent restraint of both the upper and lower torsos.

It is important for the child to sit properly within the vehicle seat belts. When the vehicle seat belt is buckled, the lap belt should be low on the hips, just touching the thighs, and the shoulder belt should lie across the middle of the shoulder. If the child leans out or moves the belt behind the back or places it under the arm, it will not provide the intended restraint.

There are a number of things to consider when deciding whether the child is ready to sit in a booster seat, including: the weight and height rating on their current child seat, the child's own weight and height, their maturity, and the seating positions available in your vehicle.

## **How is a booster seat used?**

Using a booster seat is very similar to buckling yourself into the vehicle:

- Read the instruction manuals for both the booster seat and the vehicle before you start.
- Put the booster in the back seat in a location with a lap and shoulder belt. **Never use a booster with only a lap belt**, as this could cause serious injuries.
- After the child is in the booster, pull the lap and shoulder belt across him/her and buckle it.
- Check that the shoulder belt lies across the middle of the shoulder and that the lap belt is low on the hips, just touching the thighs.

## **How can you tell if your child is ready to transition to a booster seat?**

You should consider using a booster seat if the following conditions apply:

- The child is mature enough to sit in the booster seat and not put the belts under their arm or behind their back.
- The child is approaching the weight or height limit of the child restraint they are currently using. (Even children who have not outgrown their toddler seat can benefit from the use of a booster seat, if it is used properly.)
- If you have a vehicle that does not have a tether anchorage but has lap/shoulder belts available in the back seat, a booster seat may provide better protection than an internal harness seat without the tether.



## Booster Installation Checklist

### 1. Convert child restraint to booster seat.

See "Converting into a Booster Seat," p. 34.

### 2. Secure booster seat to the vehicle seat.

- ✓ Make sure the bottom and back of the booster seat are touching vehicle seat and back.
- ✓ Level the booster seat (Canadian models only), p. 39.

**IMPORTANT:** You may use the tether strap and lower anchor connectors to secure this booster seat to the vehicle seat as long as the position of the booster seat in the vehicle and/or the resulting fit of the vehicle seat belt over the child **are not affected**.

### 3. Place the child in the booster seat.

- ✓ Make sure the child's back and bottom are flat against the back and bottom surfaces of the booster seat.
- ✓ Make sure the booster seat is level.

### 4. Secure child and booster seat to vehicle seat.

- ✓ Stretch the lap/shoulder belt across the child and fasten the buckle.
- ✓ The shoulder belt **MUST** be routed properly (p. 38).
- ✓ Make sure the shoulder and lap belts are threaded under the red lap belt guide (Canadian models only).

### 5. Check your work.

Make sure the lap belt is stretched low and snug across the child's hips, within the belt guides, and fastened into the buckle. The shoulder belt must cross the child midway between his/her shoulder and neck.

## **⚠ WARNING DEATH or SERIOUS INJURY can occur.**

- The shoulder belt **MUST NOT** cross the child's neck or fall off the child's shoulder. If you cannot adjust the shoulder belt to properly lay midway between the child's shoulder and neck **AND** at or above the shoulder, try another seating location, or do not use the booster seat.



**TIP!** To make installation easier, watch the installation video of this booster seat at [www.evenflo.com](http://www.evenflo.com).

## ***Converting into a Booster Seat***

---



### ***1. Loosen harness.***

Press the harness release button while pulling outward on the harness straps, as shown. Disconnect the chest clip.

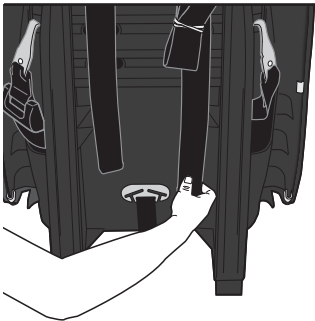

### ***2. Remove both Harness Straps from the Splitter Plate and pull them through to the front of the seat.***



### ***3. Disconnect all J-clips and all Retaining Strips, then remove the Seat Pad.***

## Converting into a Booster Seat



4. Route the Harness Straps through Adjustment Slots, then attach to Splitter Plate.



**IMPORTANT:** Make sure both harness straps are installed **completely** on the splitter plate.

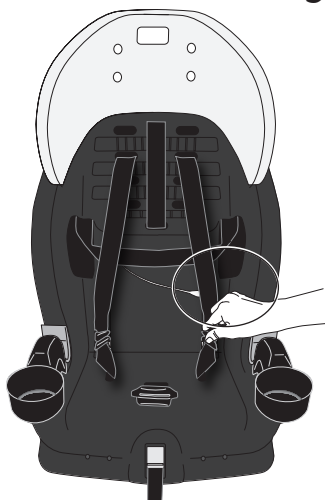

5. Tuck the Chest Clip and Buckle Tongues into the recesses on either side of the seat shell.

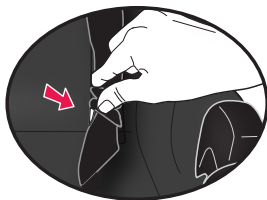

## ***Converting into a Booster Seat***

---

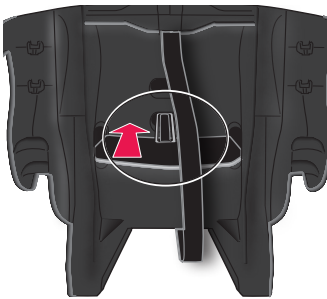

### **6. Remove the Buckle Strap.**

Locate the Buckle Strap anchor on the bottom. Turn the anchor sideways and push it through the seat shell to remove, as shown.

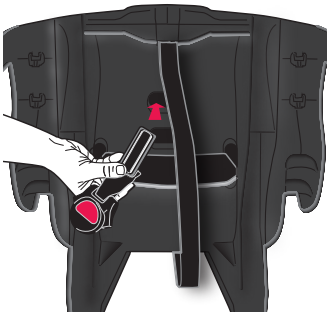
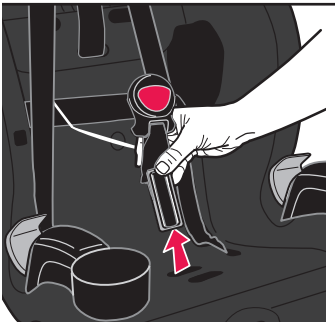
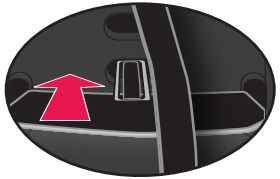

Insert the buckle strap anchor back into the opening from the bottom of the child restraint.

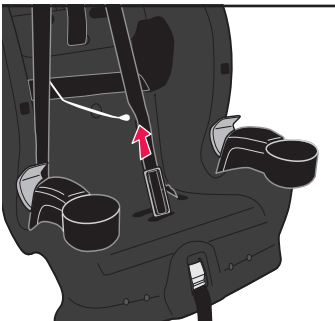

Pull the anchor through the seat and adjust so it lies flat.

## Converting into a Booster Seat



Using as a Booster Seat

### **7. Install the seat pad.**

Your child restraint is now a booster seat and ready for a child who meets the following requirements:

- **Weight:** 18.1 – 45.3 kg (40 – 100 lbs)
- **Height:** 110 to 145 cm (43.3 to 57 in) and tops of the child's ears are at or below the top of child restraint headrest
- **Age:** At least 5 years old

**NOTE:** To convert the seat back into 5-point harness mode, reverse these steps.

## ***Shoulder belt routing while in booster mode***

While the seat is used in booster mode the shoulder belt must be routed over the child's shoulder.

The belt must pass under the head rest, between the head rest and the seat as long as the child's shoulders are at or below the opening between the head rest and shell.

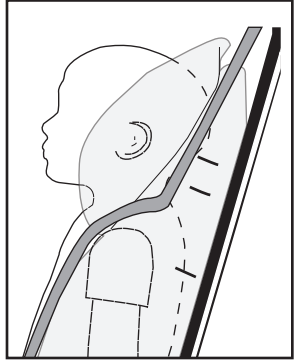

If the child's shoulders are high enough that routing the shoulder belt under the head rest causes the belt to be pulled down the back side of the child's shoulder (before passing through the head rest), the belt should not be routed between the seat and

the head rest.

If the shoulder height causes the belt to route behind the back and the top of the ears are still at or below the top of the head rest, the shoulder belt should be routed on top of the head rest.

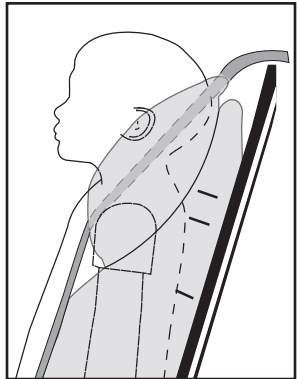

# General Information

## Leveling the Booster Seat

Canadian Models Only

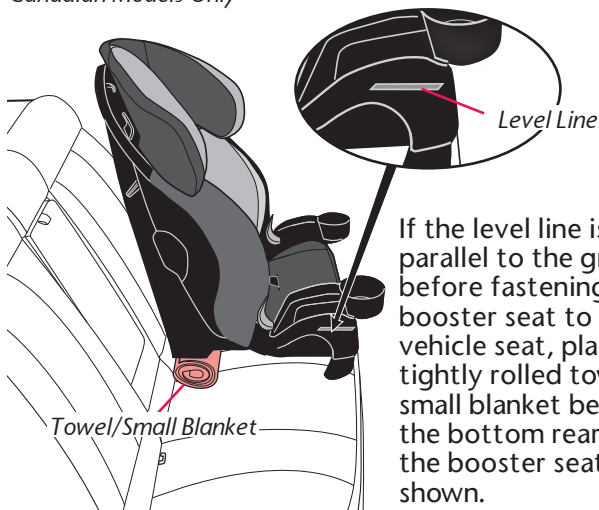

If the level line is not parallel to the ground, before fastening the booster seat to the vehicle seat, place a tightly rolled towel/ small blanket beneath the bottom rear of the booster seat, as shown.

## Installing the Cup Holders

Not available on all models.

Place each cup holder onto the seat, then turn the seat over and secure each cup holder with a screw, as shown. **Do not over tighten.** Make sure each cup holder is attached securely in place.

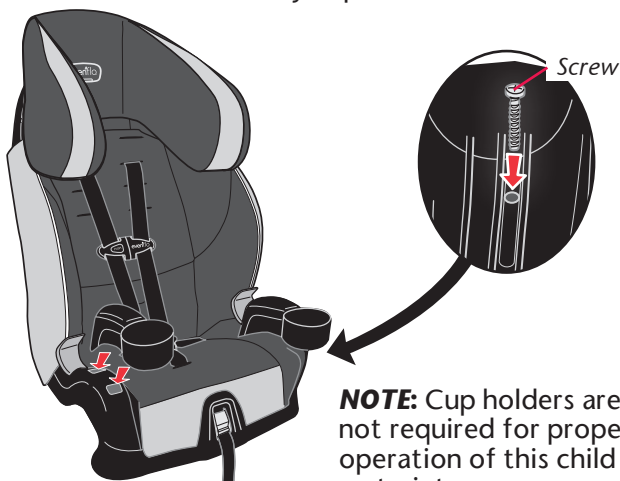

**NOTE:** Cup holders are not required for proper operation of this child restraint.

## **Removing Seat Pad**

---



### **1. Loosen harness.**

Press the harness release button while pulling outward on the harness straps, as shown. Disconnect the chest clip.

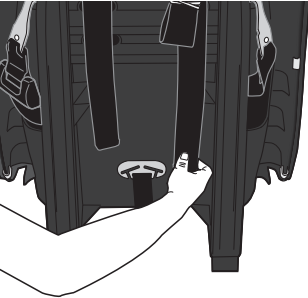

**2. Remove both Harness Straps from the Splitter Plate and pull them through to the front of the seat.**



**3. Disconnect all J-clips from the Seat Pad.**



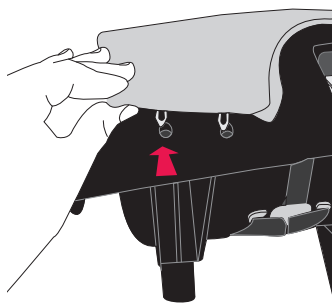

**4. Disconnect all Retaining Strips, then remove the Seat Pad.**

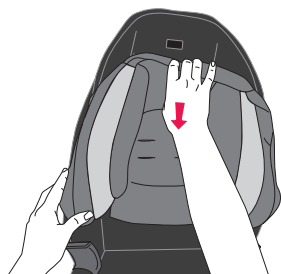

**5. Pull headrest pad off the headrest.**

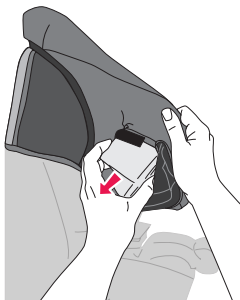

**6. Open the tab on the back of the headrest pad and pull out the foam. Repeat for the other side.**

**NOTE:** To re-attach the seat pad when in 5-point harness mode, reverse these steps.

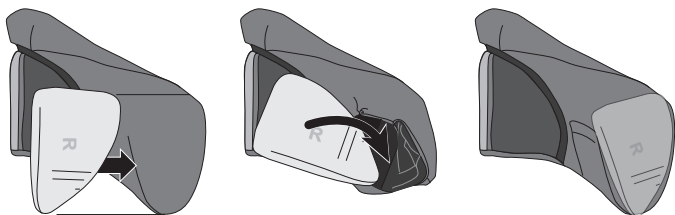

When replacing the foam, make sure the foam is in the correct orientation. Push the foam into place through the headrest pad opening and secure the foam.

## **Securing Your Child Restraint in Aircraft**

---

The Federal Aviation Administration (FAA) recommends that you secure your child for air travel in an appropriate child restraint based on your child's weight and size. Turbulence can happen with little or no warning. When turbulence occurs, **the safest place for your child is in a properly installed child restraint, not in an adult's lap or on the aircraft seat with its seat belt.** Keeping your child in a child restraint during the flight will help ensure your family arrives safely at your destination.

The FAA recommends that a child weighing:\*

- more than 18 kg (40 lbs) use an aircraft seat belt;
- less than 9 kg (20 lbs) use a rear-facing child restraint; and
- from 9 to 18 kg (20 to 40 lbs) use a forward-facing child restraint.

**\* Please note that these FAA recommendations may vary from those applicable to the use of your child restraint in a motor vehicle.**

### **IMPORTANT**

*This child restraint can only be used with a 5-point harness in aircraft. Booster seat mode cannot be used in booster mode in aircraft.*

## **Installing Child Restraint in Aircraft**

**IMPORTANT:** Before installing the child restraint, make sure the **aircraft seat is in a fully upright position.**

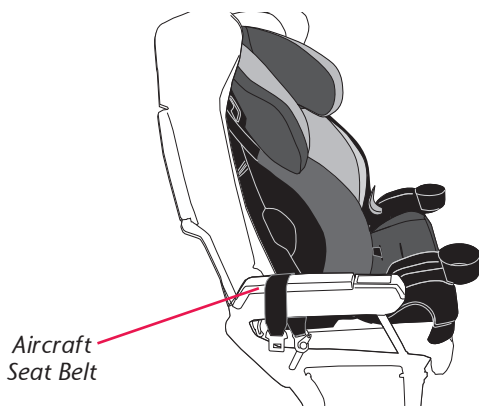

### **1. Place the child restraint in position.**

Place the child restraint on the aircraft seat forward-facing, as shown above.

# Installing Child Restraint in Aircraft

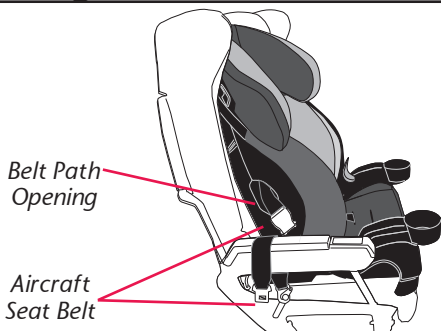

## 2. Route aircraft seat belt through belt path.

Route the aircraft seat belt through the belt path opening in the back of the child restraint and continue through the opening on the opposite side of the child restraint.

**NOTE:** Lift the restraint's seat pad away for easier access.

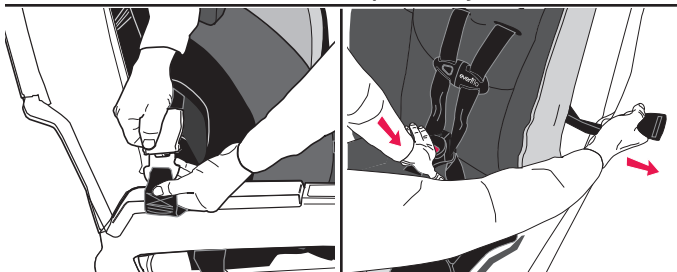

## 3. Fasten the aircraft seat belt, then remove all slack from the belt.

The aircraft seat belt must be as tight as possible.

Route the excess aircraft seat belt strap back through the belt path opening. Using your full weight, push the child restraint firmly onto the aircraft seat while pulling on the excess seat belt strap to tighten.

**NOTE:** Because of the fixed length of aircraft seat belts, the belt buckle could be behind the child's back after tightening the belt. For your child's comfort, Evenflo recommends cushioning the child's back by placing a small pillow or folded-up blanket, or a folded-up jacket, over the belt buckle.

**Check your work:** Reconnect the seat pad to the front of the child restraint. Try to move the child restraint in all directions. If you can move the restraint more than 2.5 cm (1 in) from side-to-side or front to back **at the belt path**, the aircraft seat belt is not tight enough, and you **MUST** install again until the seat belt is tight.

## 4. Secure Your Child in the Child Restraint.

Refer to page 25.

## Care and Cleaning

- **DO NOT** lubricate or immerse in water the LATCH connectors, the buckle, or any other part of this child restraint, unless rinsing is permitted, as stated on the back of the buckle for your restraint.
- Plastic and metal parts may be wiped clean with mild soap and water and dried with a soft cloth. Do not use abrasive cleaners or solvents.
- Take care not to damage any labels.
- The harness can be wiped clean with mild soap and water. Allow harness to air dry.
- Remove the EPS foam from the headrest pad before washing. See page 41. Machine wash the seat pad separately in cold water, delicate cycle. Tumble dry 10 to 15 minutes on low heat.
- **NEVER** use child restraint without the seat pad.
- To protect the child restraint from damage caused by weather, rodents, and other elements common to garages, the outdoors, and other storage locations, remove the seat pad and thoroughly clean the restraint and pad prior to storage. Take care to clean in the areas where crumbs and other debris tend to accumulate.

**Tip!**

To help protect the vehicle upholstery, place a towel beneath and behind the child restraint.

## Recording Model Information

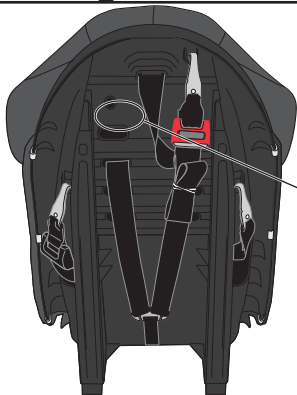

Manufactured in / Fabriqué en  
(year-month-day)/(année-mois-jour)  
Name / Nom  
Model / Modèle  
Made in / Fabriqué en  
Expires on/Expire le

For future reference, record the model number of your child restraint AND the date of manufacture below.

**Model Number:** \_\_\_\_\_

**Date of Manufacture:** \_\_\_\_\_

## ***Storing Your Instructions***

---



*After thoroughly reading and following these instructions, store them in the slots on either side of the child restraint.*

## ***Proper Disposal of this Child Restraint***

---

When this booster seat reaches the expiration date found on the date of manufacture label, Evenflo encourages you to dispose of it properly. Most components of this child restraint are recyclable.

1. Remove all fabric and padding.
2. Remove all screws and disassemble the restraint.
3. Recycle all fabric, padding, plastic, foam and metal parts, if accepted by your local recycling center. Responsibly discard the rest.

If your local recycling center won't accept the padding, you may dispose of it in the landfill.

***To prevent injury due to hidden damage, lost instructions, outdated technology, etc., discontinue use of this restraint after date on the Date/Model label (below), OR if it has been involved in a crash.***

# Replacement Parts

---

Not available on all models.

You can order replacement parts online at [www.evenflo.com](http://www.evenflo.com) or contact Evenflo. When you contact us, please have the product model number and date of manufacture (found on the back of the child restraint).

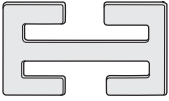

Locking Clip:  
Not included with  
child restraint,  
see page 23.



Cup Holder/  
Armrest

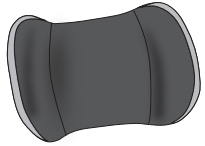

Head Pillow

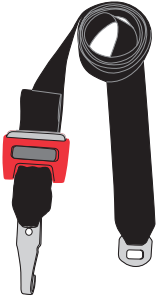

Tether Extender



Chest Clip



Harness System

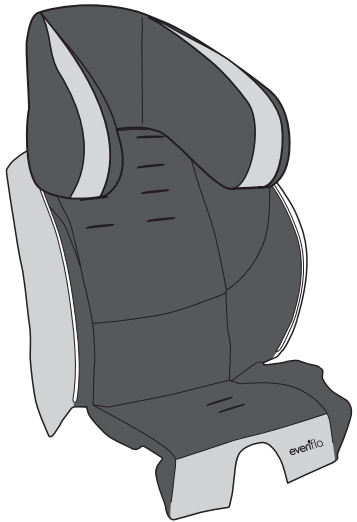

Seat Pad



Lower Anchor  
Connector Assembly

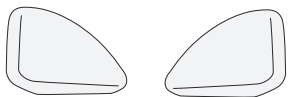

Head Foam

## ***Limited Warranty***

---

For a period of 90 days from the original purchase of this Product, Evenflo warrants to the original end user ("Purchaser") this Product (including any accessories) against defects in material or workmanship. Evenflo's sole obligation under this express limited warranty shall be, at Evenflo's option, to repair or replace any Product that is determined to be defective by Evenflo and determined to be covered by this warranty.

Repair or replacement as provided under this warranty is the exclusive remedy of the Purchaser. Proof of purchase in the form of a receipted invoice or bill of sale evidencing that the Product is within the warranty period must be presented to obtain warranty service. This express limited warranty is extended by Evenflo ONLY to the original Purchaser of the Product and is not assignable or transferable to subsequent purchasers or end users of the Product. For warranty service, contact Evenflo's ParentLink Consumer Resource Center.

EXCEPT TO THE EXTENT PROHIBITED BY APPLICABLE LAW, ANY IMPLIED WARRANTY OF MERCHANTABILITY OR FITNESS FOR A PARTICULAR PURPOSE ON THIS PRODUCT IS HEREBY DISCLAIMED. EVENFLO SHALL NOT BE LIABLE FOR ANY INCIDENTAL, CONSEQUENTIAL, SPECIAL OR PUNITIVE DAMAGES OF ANY KIND FOR BREACH OF THE EXPRESS LIMITED WARRANTY ON THIS PRODUCT, OR ANY WARRANTY IMPLIED BY OPERATION OF LAW. OTHER THAN THE EXPRESS LIMITED WARRANTY SET FORTH ABOVE, THERE ARE NO OTHER WARRANTIES THAT ACCOMPANY THIS PRODUCT AND ANY ORAL, WRITTEN OR ANY OTHER EXPRESS REPRESENTATION OF ANY KIND IS HEREBY DISCLAIMED.

**ParentLink®**

answers. advice. affirmation.™

**[www.evenflo.com](http://www.evenflo.com)**

**USA:** 1-800-233-5921, 8 AM to 5 PM E.T.

**Canada:** 1-937-773-3971

# ParentLink®

answers. advice. affirmation.™

**[www.evenflo.com](http://www.evenflo.com)**

**USA:** 1-800-233-5921, 8 AM to 5 PM E.T.

**Canada:** 1-937-773-3971