

## Features

- A single handle controls both on/off activation and temperature setting
- 9" (229 mm) spout reach
- 7.5 gpm (28.4 lpm) maximum bath faucet flow rate at 45 psi (3.1 bar)
- 1.75 gpm (6.6 lpm) maximum handshower flow rate at 80 psi (5.5 bar)
- KOHLER® ceramic disc valves exceed industry longevity standards for a lifetime of durable performance
- Coordinates with other products in the Riff collection

## Material

- Premium metal construction for durability and reliability
- KOHLER finishes resist corrosion and tarnishing

## Installation

- Floor-mount

## Required Products/Accessories

For freestanding installation  
K-97339 Mounting block for select floor-mount bath fillers

## Recommended Products/Accessories

K-27409 18" towel bar  
K-27410 24" towel bar  
K-27411 Double robe hook  
K-27412 Towel ring  
K-27413 Pivoting toilet paper holder

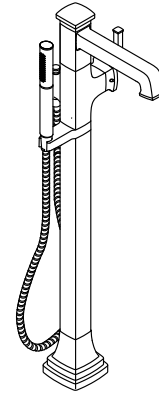

## Codes/Standards





ASME A112.18.1/CSA B125.1  
DOE - Energy Policy Act 1992  
EPA WaterSense®  
California Energy Commission (CEC)

## KOHLER® Faucet Lifetime Limited Warranty

See website for detailed warranty information.

## Available Colors/Finishes

*Color tiles intended for reference only.*

Color	Code	Description
	CP	Polished Chrome
	SN	Vibrant® Polished Nickel
	BN	Vibrant® Brushed Nickel
	BL	Matte Black
	2MB	Vibrant® Brushed Moderne Brass

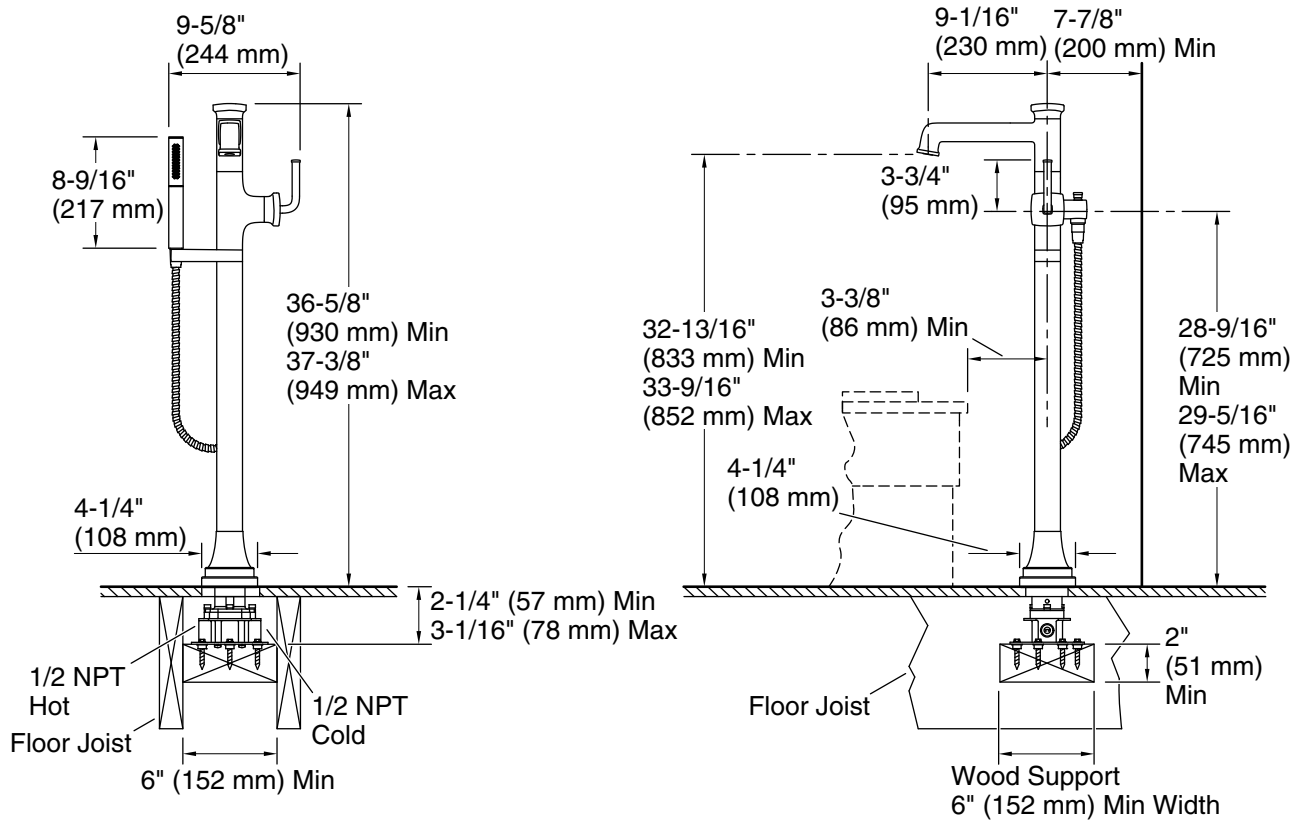

### Technical Information

All product dimensions are nominal.

Faucet flow rate: 7.5 gal/min (28.4 l/min)

### Spout:

Spout reach: 9-1/16" (230 mm)

Handshower rated max flow: 1.75 gal/min (6.6 l/min)

### Notes

Install this product according to the installation instructions.