

## HLS Ladder Tray Tray Section

# HUBBELL

## Triangle Wall Support Bracket

### Features

- HLS Ladder Tray is a modular system that is easily configured for all unique installations
- Ladder tray sections universally work with all ladder tray accessories
- HLS Ladder feature rung spacing every 9" to support and relieve cable stress

### Ordering Information

Color	Width	Catalog Number	UPC Number
Black	6"	HLTSB06B	662620819747

### Specifications

Material	Steel
Finish	Black
Installation	Mounts to Wall

### Accessories

Ladder Splice Kit	<b>HLBSK</b>
Protective End Caps	<b>HLCEPK2</b>
Black Velcro Roll	<b>HVFBK575</b>
9" Velcro Strips, Yellow	<b>MCCMV9YL10</b>

### Online Resources

Brochure  
Customer Drawing  
Customer Use Drawing  
eCatalog

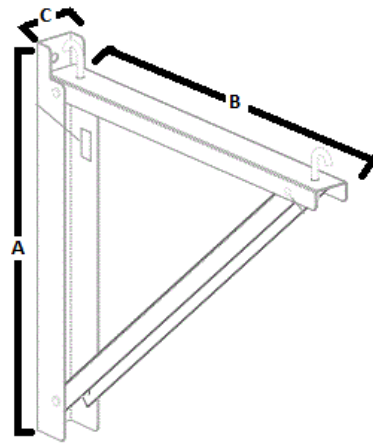

### Dimensions- inches (mm)

A	7" (178)
B	7" (178)
C	0.89" (23)