



bestchoiceproducts



INSTRUCTION MANUAL

Pre-Lit Moose Family
Yard Decoration



Assembly is similar for the bull and calf. Please follow these steps to assemble each moose.

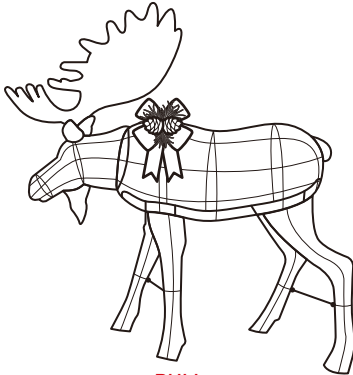

BULL

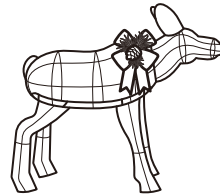

CALF

! NOTICE

Please retain these instructions for future reference.

- This product is intended for outdoor use and should be assembled outdoors only.
- This item is not intended for permanent installation or use.
- Unplug item when not in use or if left unattended.
- Ensure that your voltage is consistent with specifications.
- If any parts are missing, broken, damaged, or worn, stop using this product until repairs are made and/or factory replacement parts are installed.
- Do not use this item in a way inconsistent with the manufacturer's instructions as this could void the product warranty.

⚠ WARNING

- Do not plug into a wall outlet until item is fully assembled and lights are properly connected.
- Do not use in extreme weather conditions.
- This product contains glitter, do not assemble indoors to avoid unintended property damage and cleanup.
- Do not allow glitter to contact your eyes or face as this may result in skin irritation or injury.
- Keep item away from all heat sources (fireplace, stove, heater, etc.).
- Do not secure wiring with staples, nails, or sharp hooks.
- Do not hang ornaments or other objects from the cord.
- Unplug item before removing or changing bulbs.
- Replace burned-out bulbs immediately. Make sure to purchase bulbs of the same rated voltage and wattage.

HARDWARE

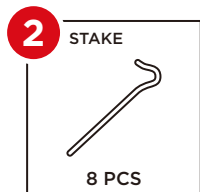
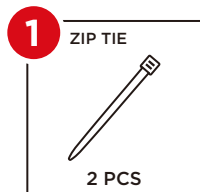

PARTS

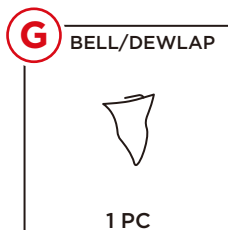
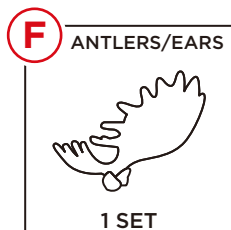
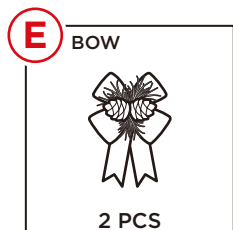
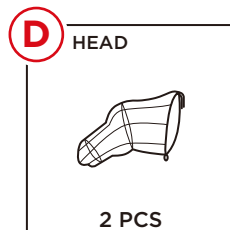
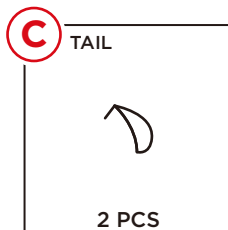
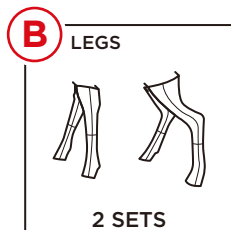
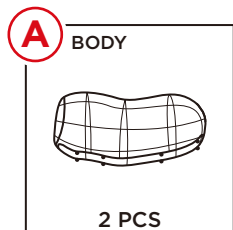

Parts are loosely attached to one another with string lights. Be careful when handling parts as they are joined together with electric wires. **This product is intended for outdoor use, assemble outdoors only.**

PRODUCT ASSEMBLY

1

Carefully remove protective wrap. Do not use a knife to avoid damaging parts or light bulbs.
Insert part B legs into the designated holes on the part A body.

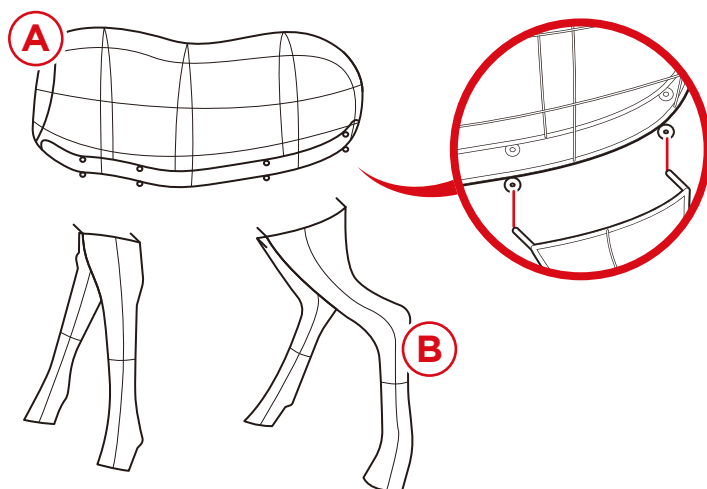

2

Insert the rod on a front leg into the designated hole on the other front leg. Repeat on the back legs.
Insert the part C tail.

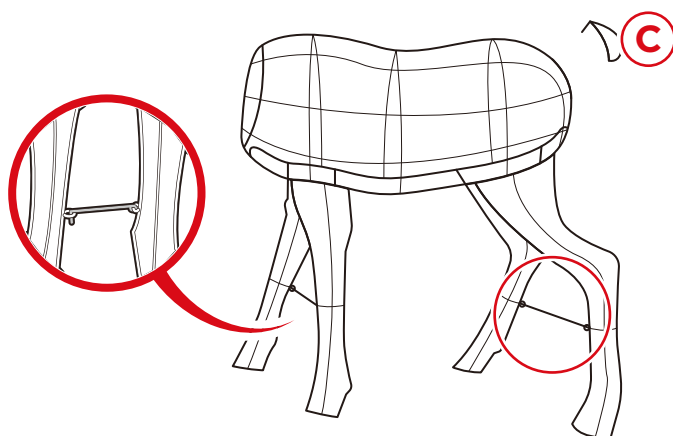

PRODUCT ASSEMBLY

3

Insert the part D head. Secure the front of the neck with a part 1 zip tie.

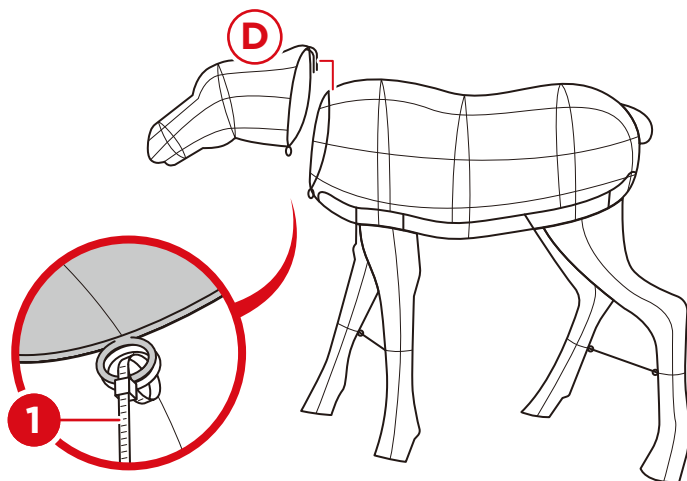

4

FOR BULL ONLY: Insert the part F antlers/ears and part G bell/dewlap.

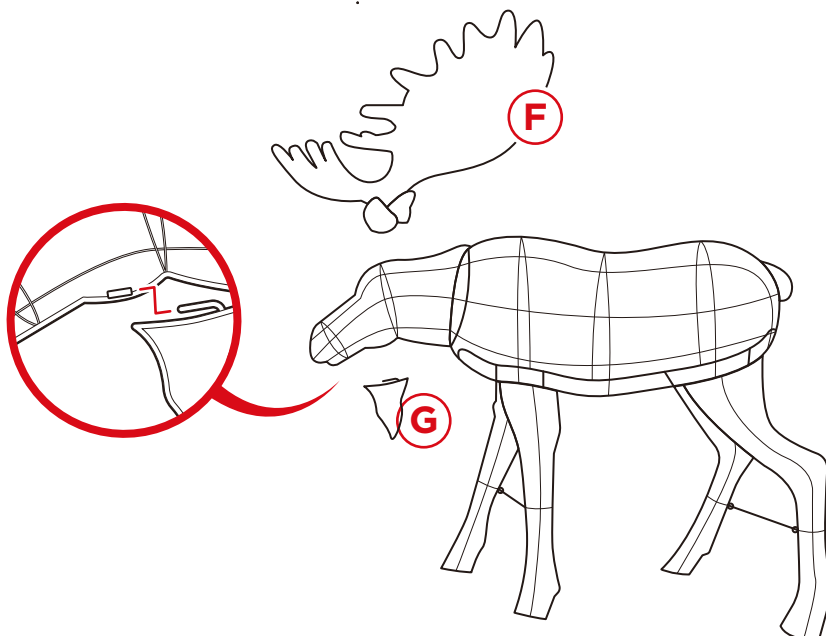

PRODUCT ASSEMBLY

5

Attach the part E bow.

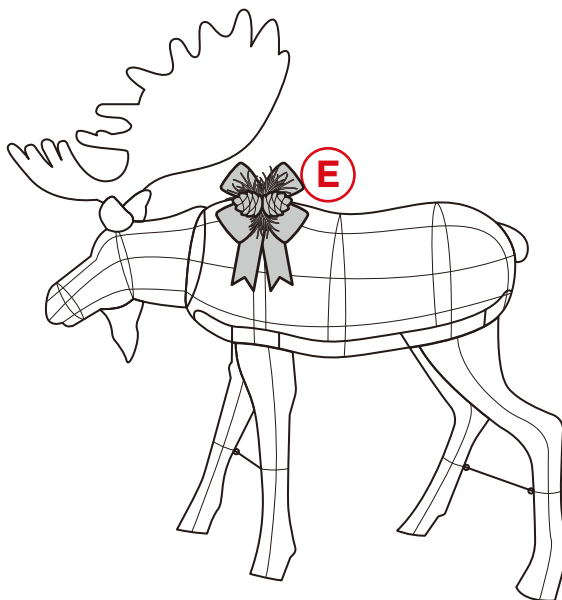

6

Secure the moose to the ground with four part 2 stakes. Plug into a wall outlet to turn on lights. Repeat steps to build additional moose.

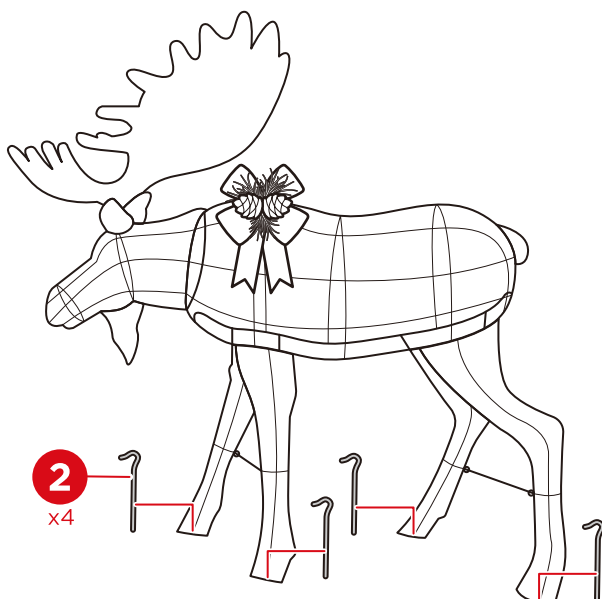

TROUBLESHOOTING

PROBLEM	REASON	SOLUTION
One section does not light	Broken or loose bulb	Inspect bulbs individually and replace broken bulbs
Lights do not work	Not plugged in	Firmly plug into wall outlet
	Extension cord does not have power	Plug in/turn on extension cord
	Broken or loose bulb	Inspect bulbs individually and replace broken bulbs
	Blown fuse	Replace fuse on plug



HELP CENTER



Question about your product? We're here to help. Visit us at:

help.bestchoiceproducts.com



Chat Support



Product Inquiry



Orders FAQ



Product Assembly



Returns & Refunds

PRODUCT WARRANTY INFORMATION

All items can be returned for any reason within 60 days of the receipt and will receive a full refund as long as the item is returned in its original product packaging and all accessories from its original shipment are included. All returned items will receive a full refund back to the original payment method. All returned items will not be charged a re-stocking fee.

All returned items require an RA (Return Authorization) number, which can only be provided by a Best Choice Products Customer Service Representative when the return request is submitted. Items received without an RA may not be accepted or may increase your return processing time. Once an item has been received by Best Choice Products, refunds or replacements will be processed within 5 business days.

All returns must be shipped back to the Best Choice Products Return Center at the customer's expense. If the reason for return is a result of an error by Best Choice Products then Best Choice Products will provide a pre-paid shipping label via email. Boxes for return shipping will not be provided by Best Choice Products, and is the customer's responsibility to either use the original shipping boxes or purchase new boxes.

Pictures may be required for some returns to ensure an item is not damaged prior to its return. Items returned are not considered undamaged until they are received by Best Choice Products and verified as such. All damages to items are the customer's responsibility until the item has been received by and acknowledge by Best Choice Products as undamaged.



WARNING

Manufacturer and seller expressly disclaim any and all liability for personal injury, property damage or loss, whether direct, indirect, or incidental, resulting from the incorrect attachment, improper use, inadequate maintenance, unapproved modification, or neglect of this product.