

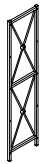

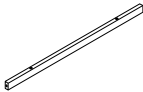

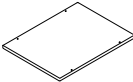



# ASSEMBLY INSTRUCTION

## BOOKCASE WITH SHELVES

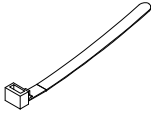
<b>A</b> Side Frame  2PCS	<b>B</b> Shelf Support Bar  10PCS	<b>C</b> Shelf  5PCS	<b>D</b> Bolt 1/4" x 35mm  20PCS
<b>E</b> Bolt 1/4" x 43mm  20PCS	<b>F</b> L-Allen Key 4mm  1PC	<b>G</b> Strap 240 x 7mm (Anti-Tipping Kit)  1PC	<b>H</b> Plastic Bracket 43 x 20mm (Anti-Tipping Kit)  2PCS
<b>I</b> Wall Anchor M4 (Anti-Tipping Kit)  2PCS	<b>J</b> Screw M4 x 30mm (Anti-Tipping Kit)  2PCS	<b>K</b> Screw M4 x 15mm (Anti-Tipping Kit)  2PCS	

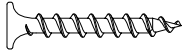

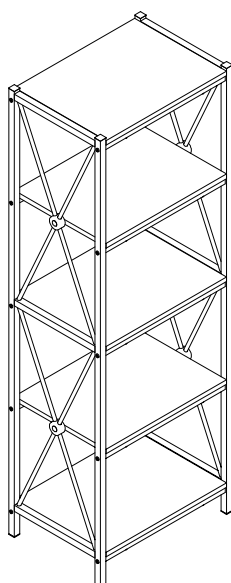
This page lists all the contents included in the box. Please take the time to identify the hardware as well as the individual components to this product. As you unpack and prepare for assembly, place the contents on a carpeted or padded area to protect them from damage.

1

Attach the Shelf Support Bar (B) to Side Frame (A), insert the Bolt (E), turn the L-Allen Key (F) to tighten them.

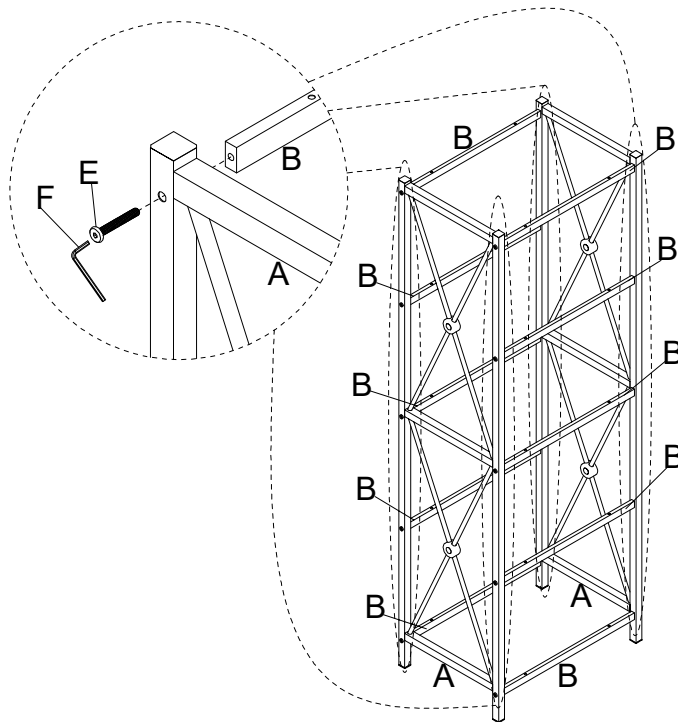

2

Attach the Shelf (C) to Shelf Support Bar (B), insert the Bolt (D), turn the L-Allen Key (F) to tighten them.

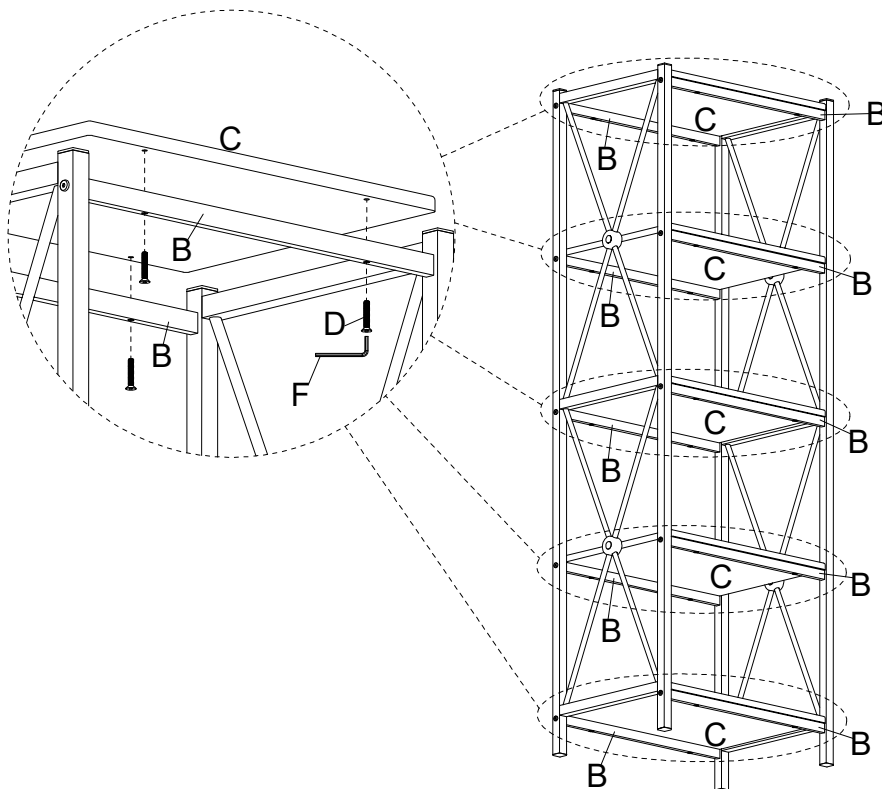

**3**

Drill two holes in the wall and insert the Wall Anchor (I) into the holes. Attach the Plastic Bracket (H) to the back of the top Shelf (C) using the Screw (K) and a Phillips Screwdriver (not provided). Then attach the other Plastic Bracket (H) to the Wall Anchor (I) and the wall using Screw (J) and a Phillips Screwdriver (not provided). Move the bookcase to its final position. Thread the Strap (G) through each Plastic Bracket (H) and pull the Strap (G) tight as shown.

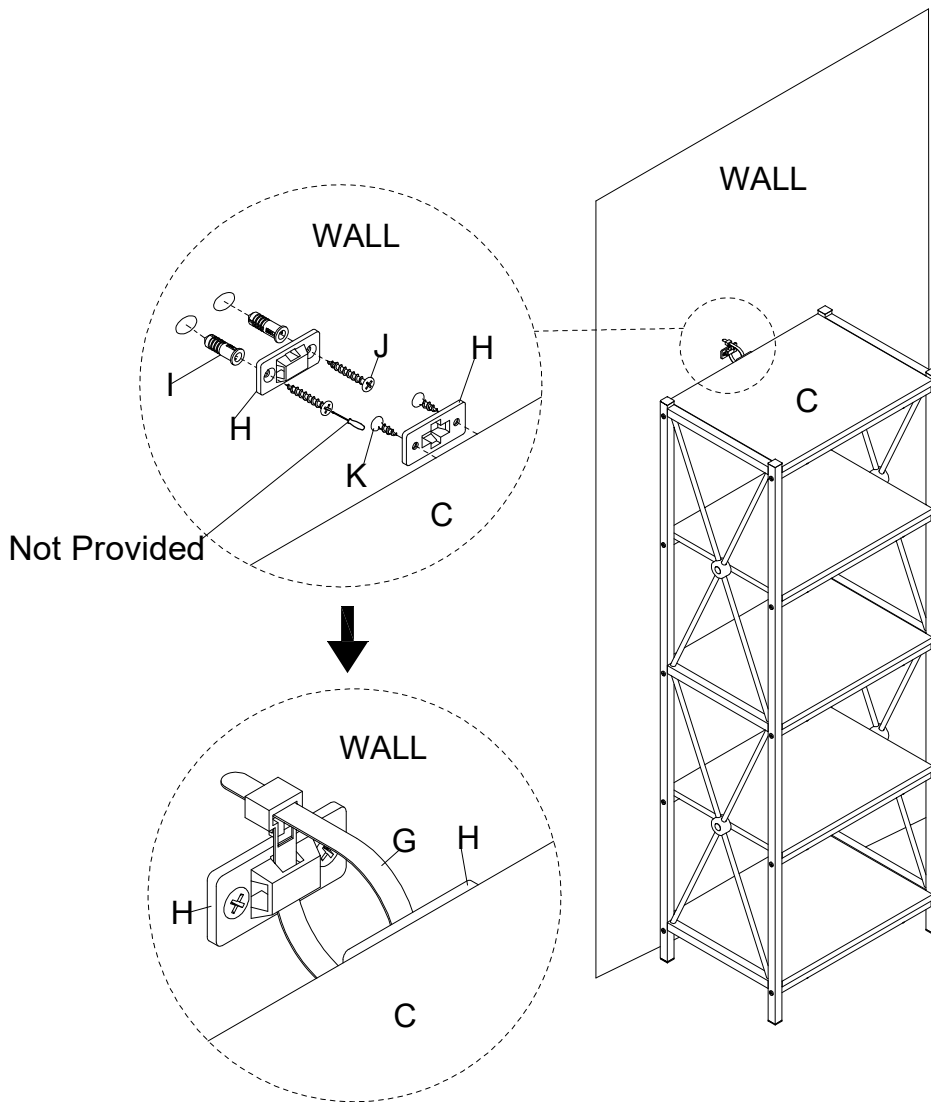

### Cleaning & Care

Treat surfaces with care. Surfaces are resistant to scratches but are not scratch resistant. Clean surfaces with a dry or damp soft cloth. Do not use abrasive cleaners. Hardware may loosen over time. Periodically check that all connections are tight.