

# 2207011B BRINDLEWOOD CAR PORT 20x12 Container Loading Diagram

( 1 set=8 boxes 35 sets/40HQ, 20 pallets/ 40HQ, Weight: 16715Kg)

Top view

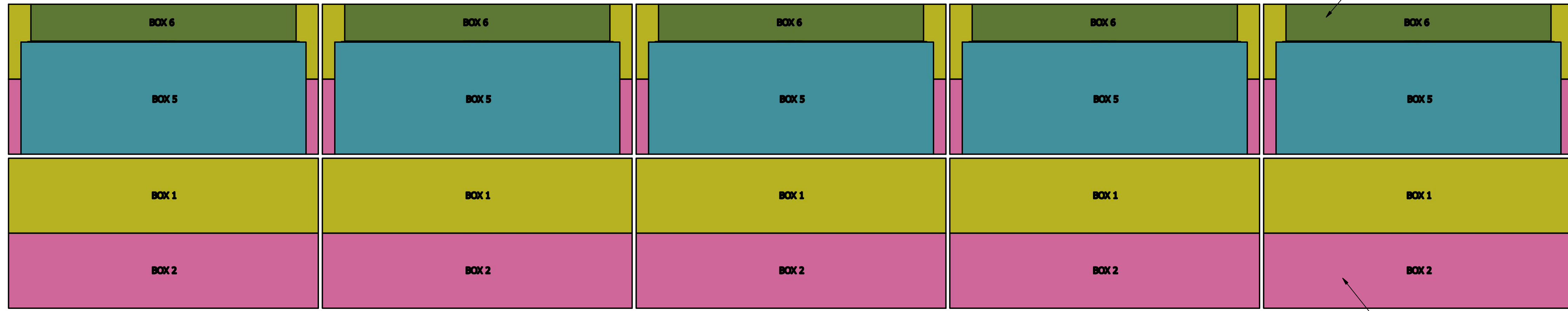

Pallet C \* 5

Side view

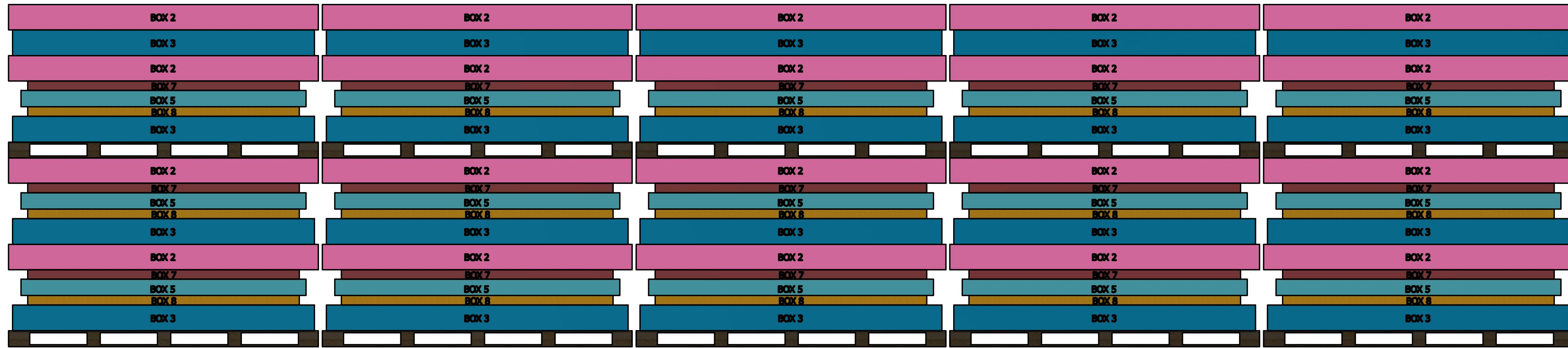

Pallet B \* 5

End view

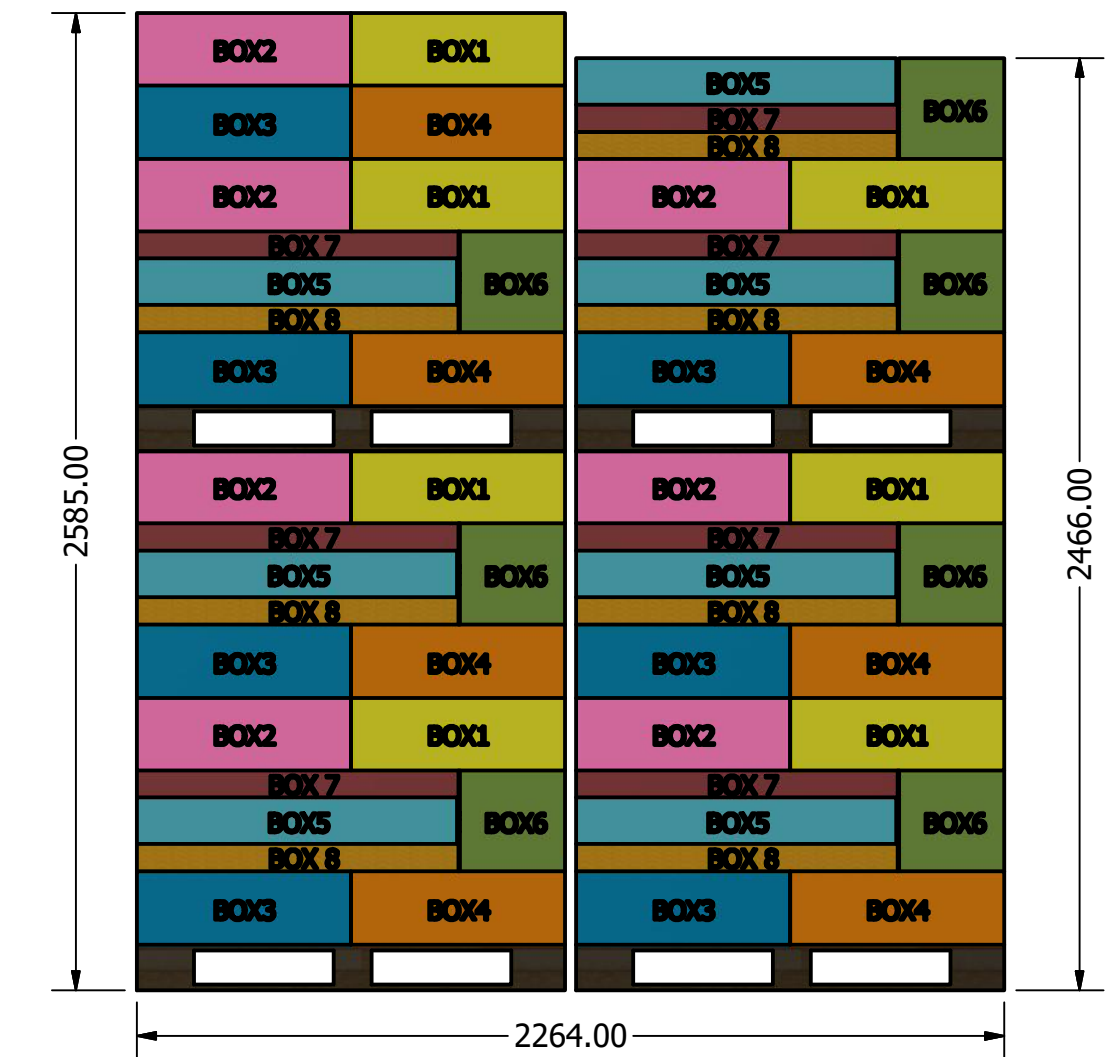

Pallet A \*10

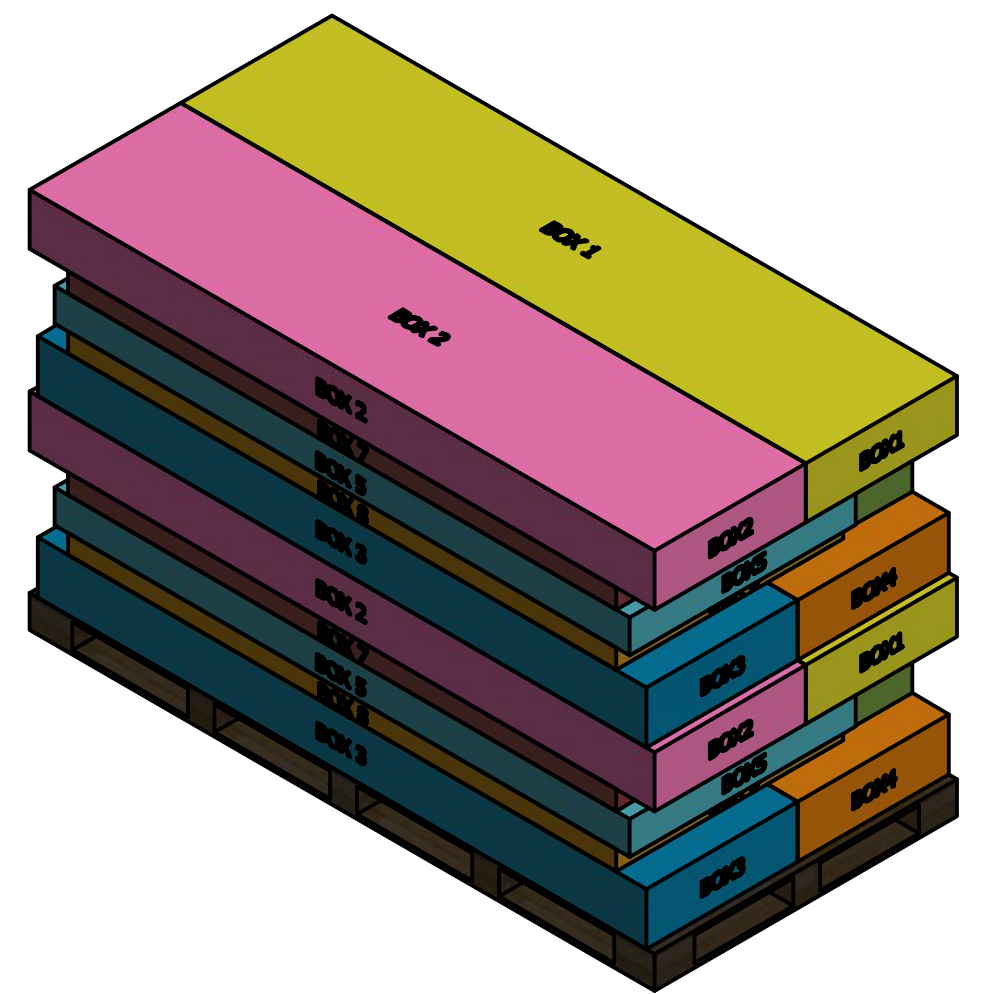

Pallet A  
(2 sets/ Pallets)

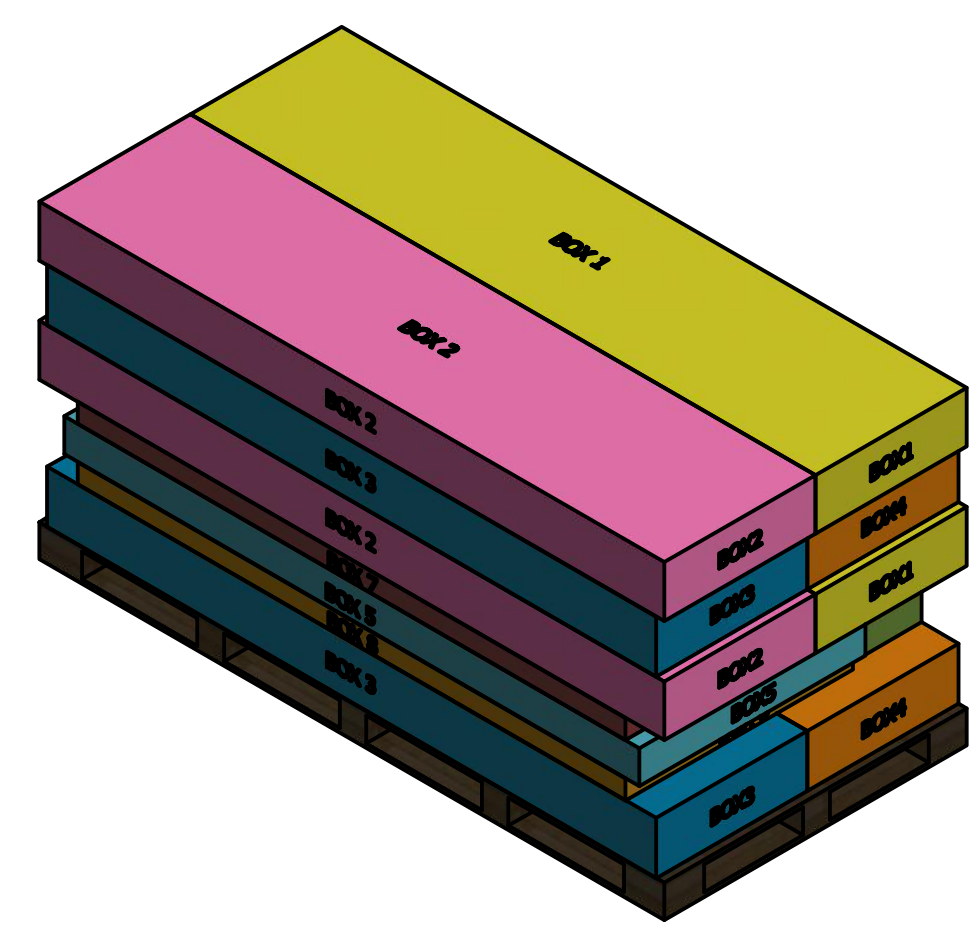

Pallet B  
(1.5 sets/ Pallets)

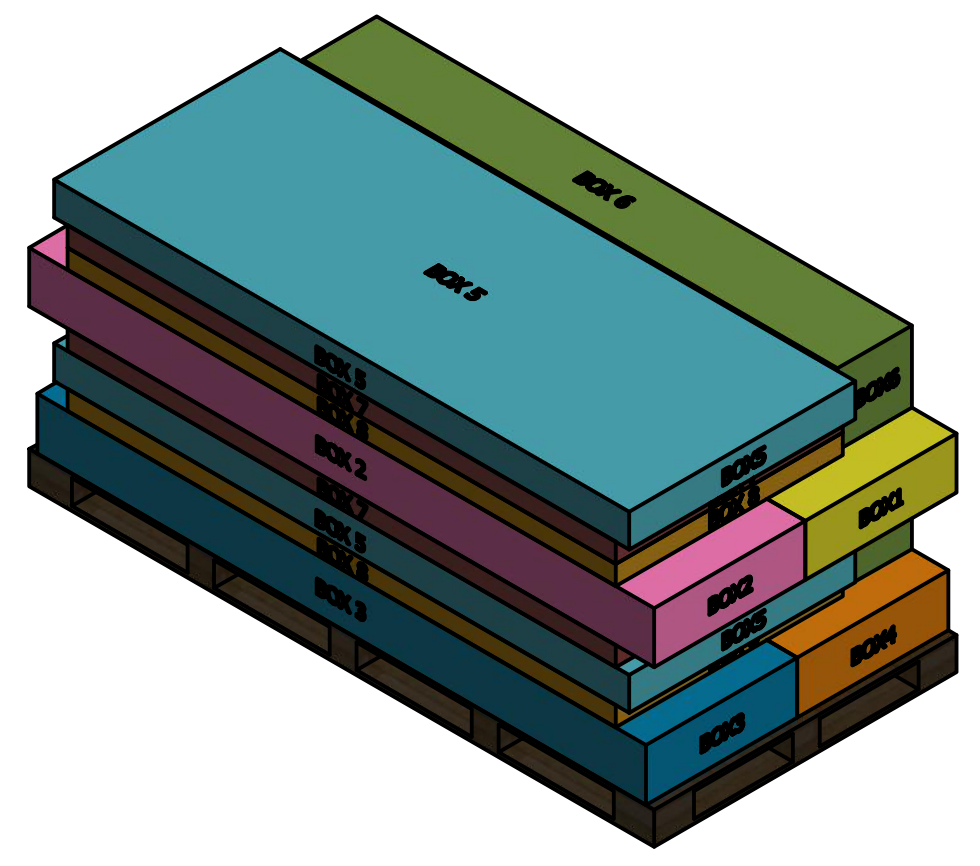

Pallet C  
(1.5 sets/ Pallets)

DRAWN	Rudy	2019/8/19		
CHECKED			TITLE	
QA				
MFG				
APPROVED				
			SIZE	DWG NO
			D	2006522
			SCALE	1 / 20
			SHEET 1 OF 1	

Pallet A ( 2 sets/pallet )

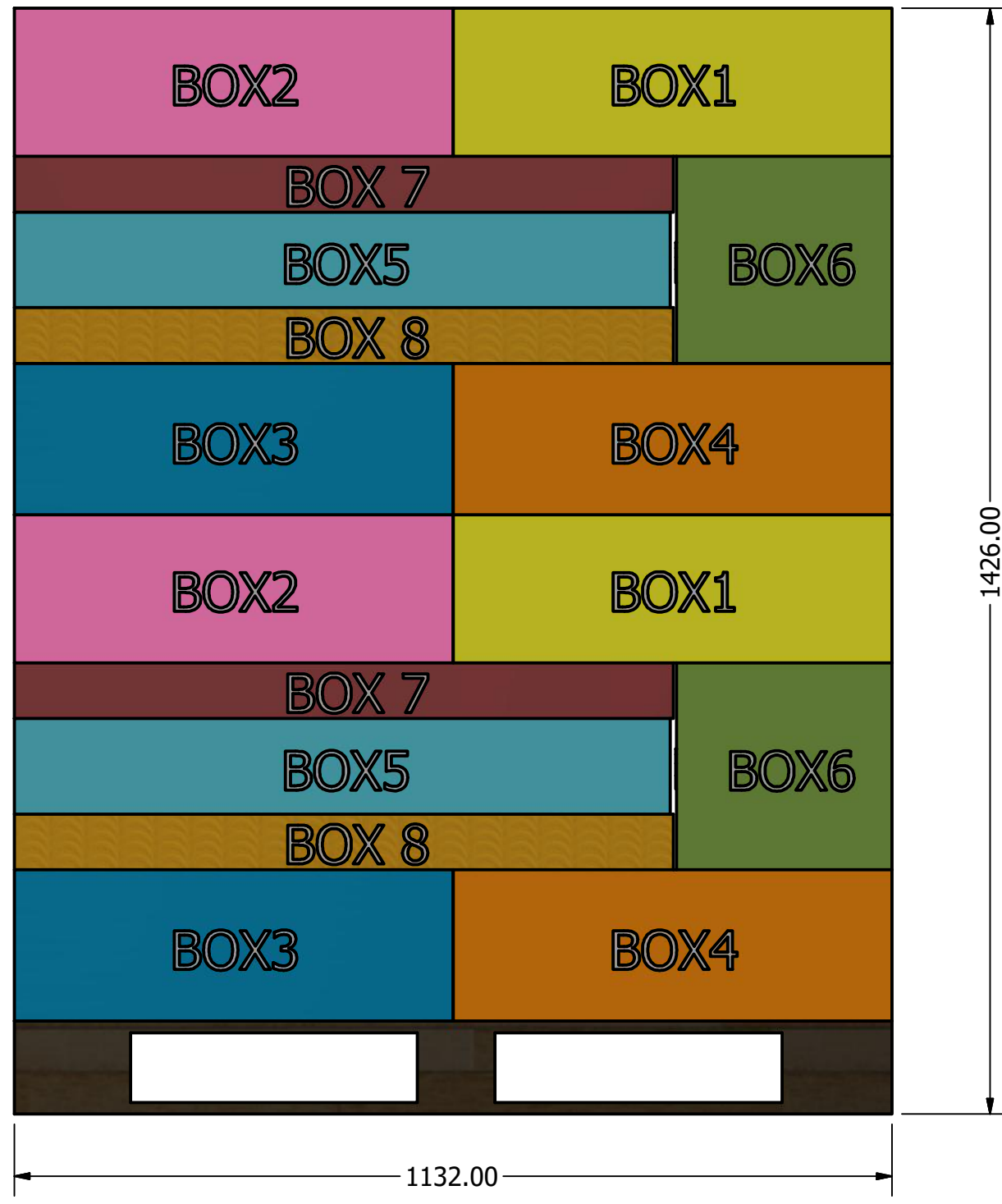
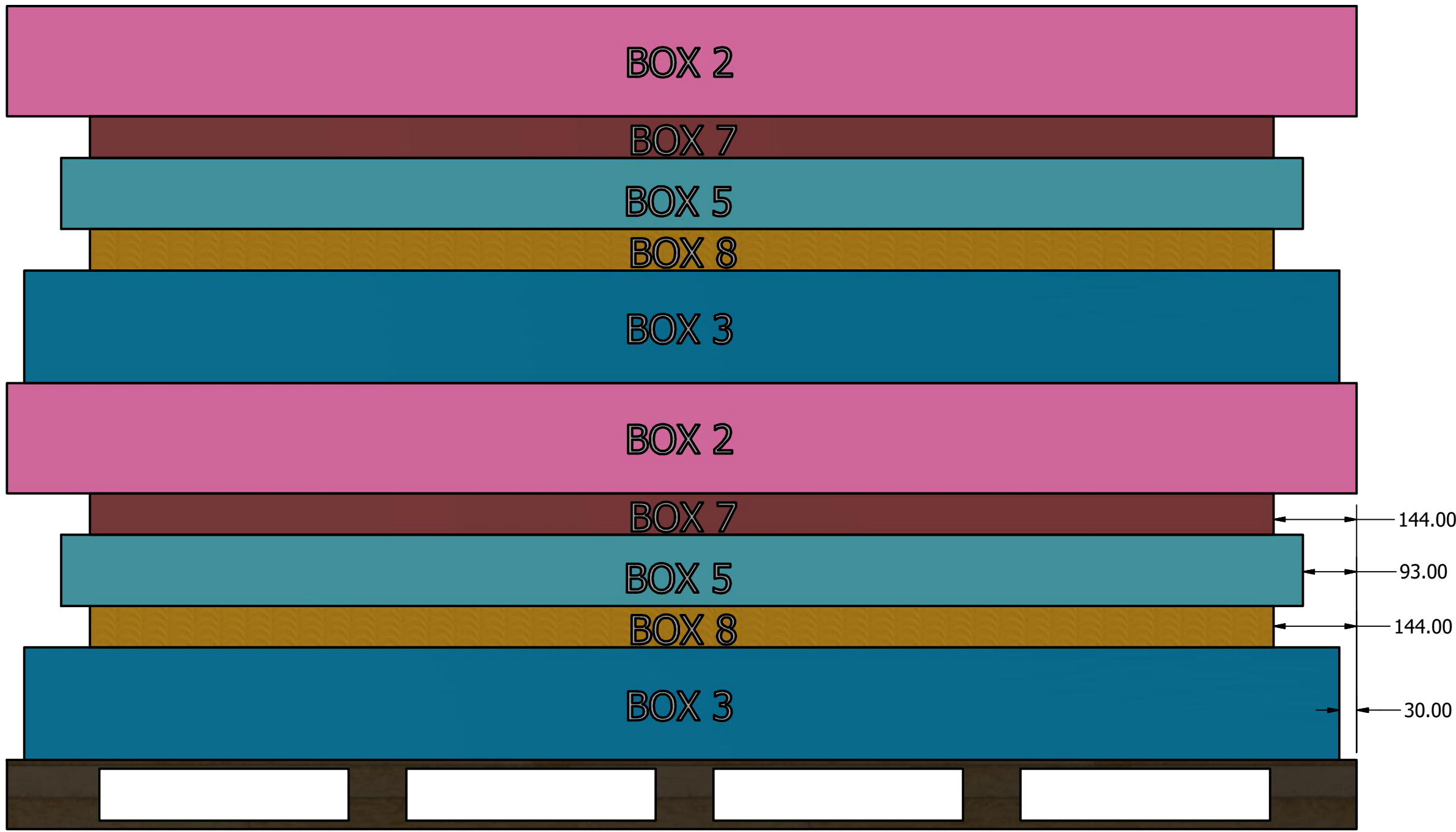
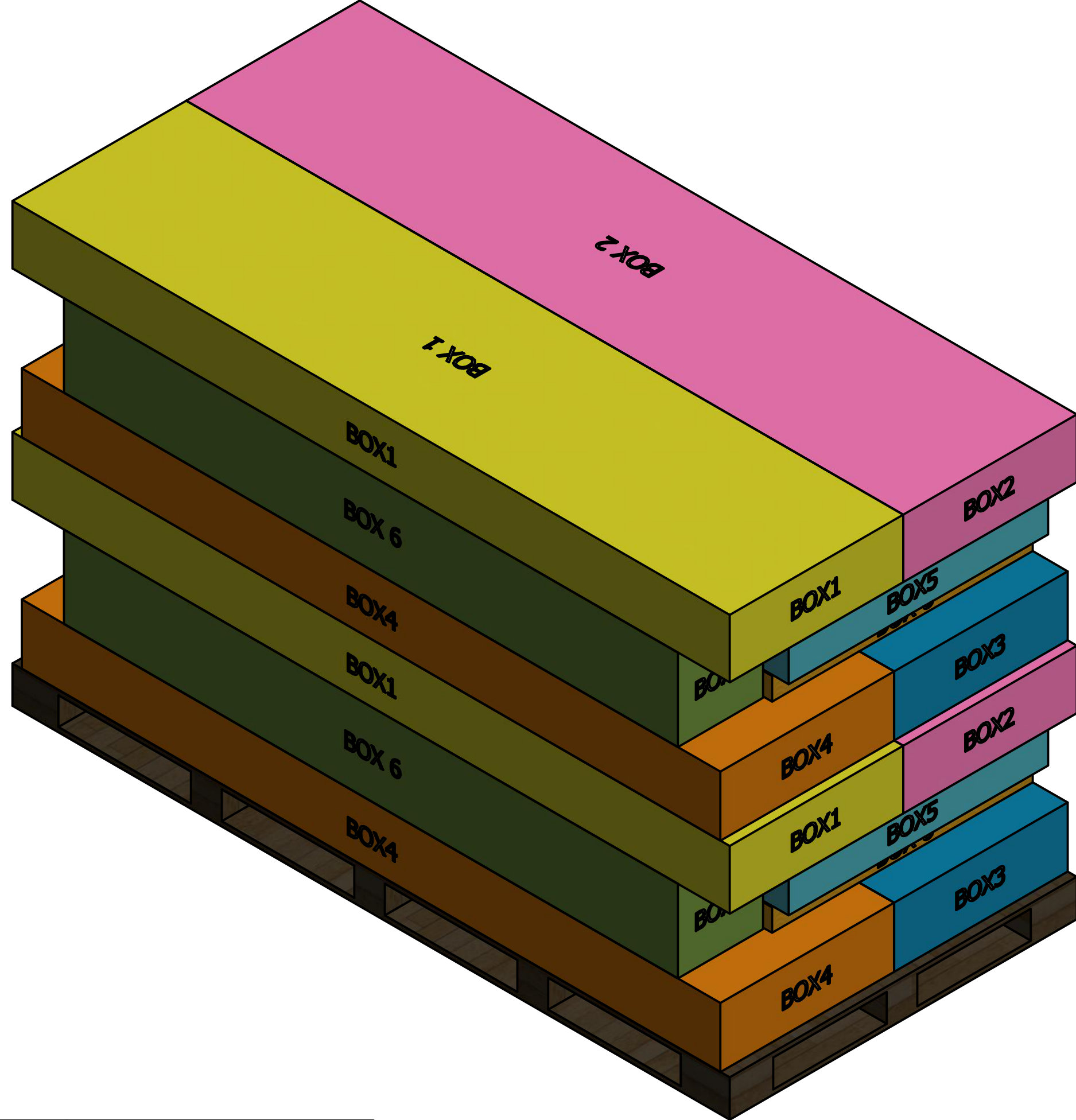
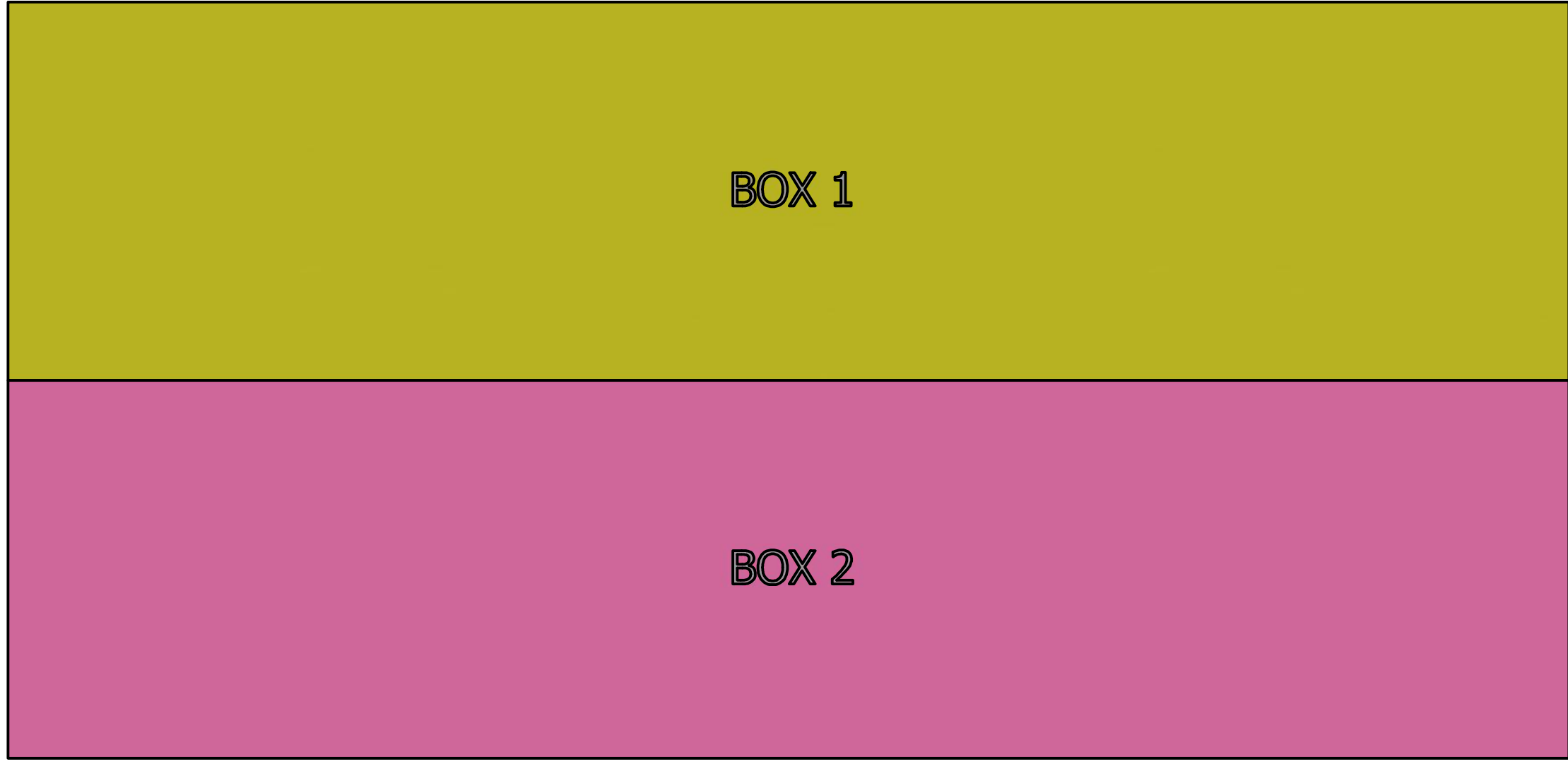

DRAWN Rudy	2019/8/19		
CHECKED		TITLE	
QA			
MFG			
APPROVED			
		SIZE D	DWG NO Pallet A
		SCALE 1 : 10	REV
		SHEET 1 OF 1	

Pallet B ( 1.5 sets/pallet )

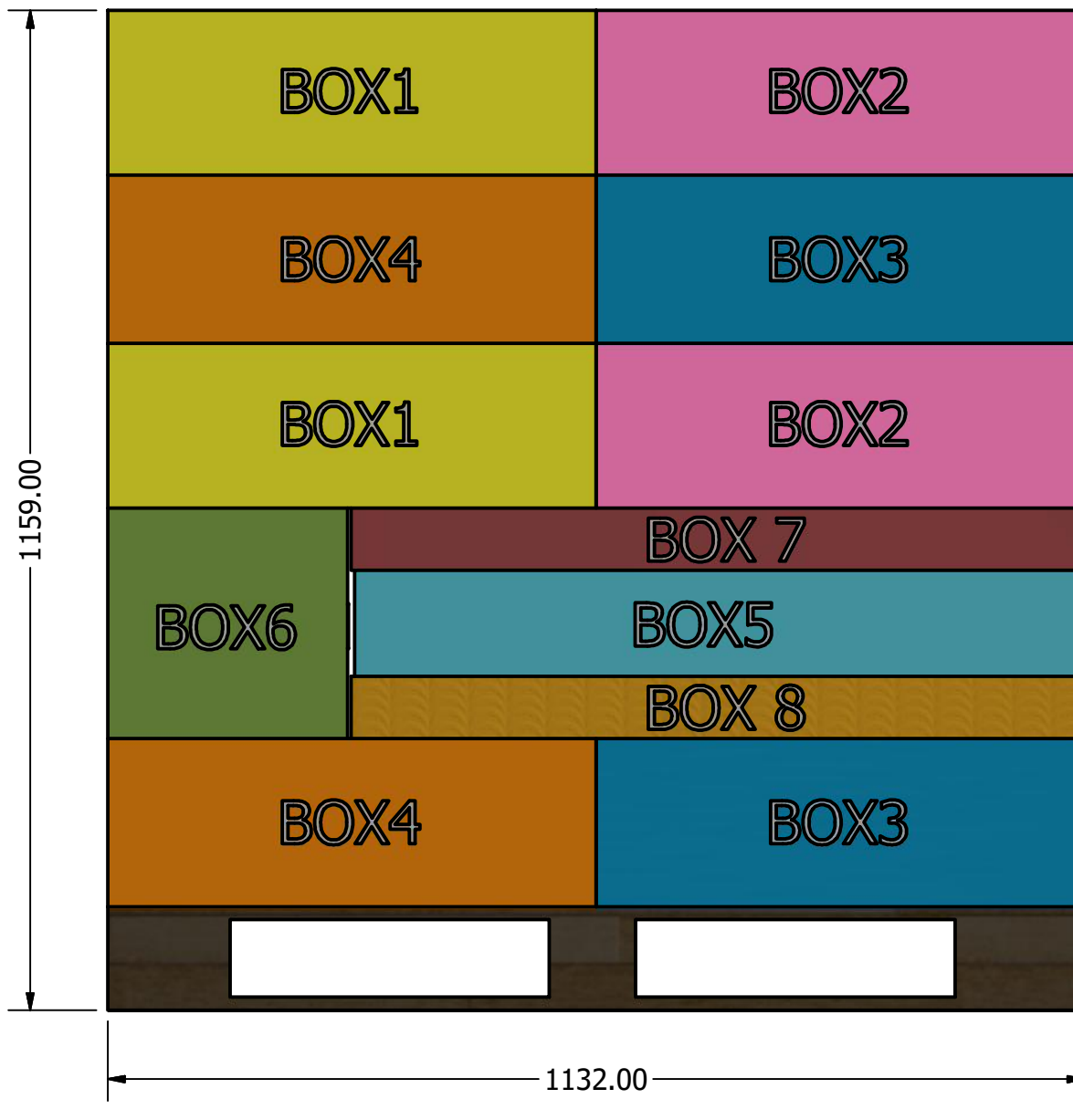
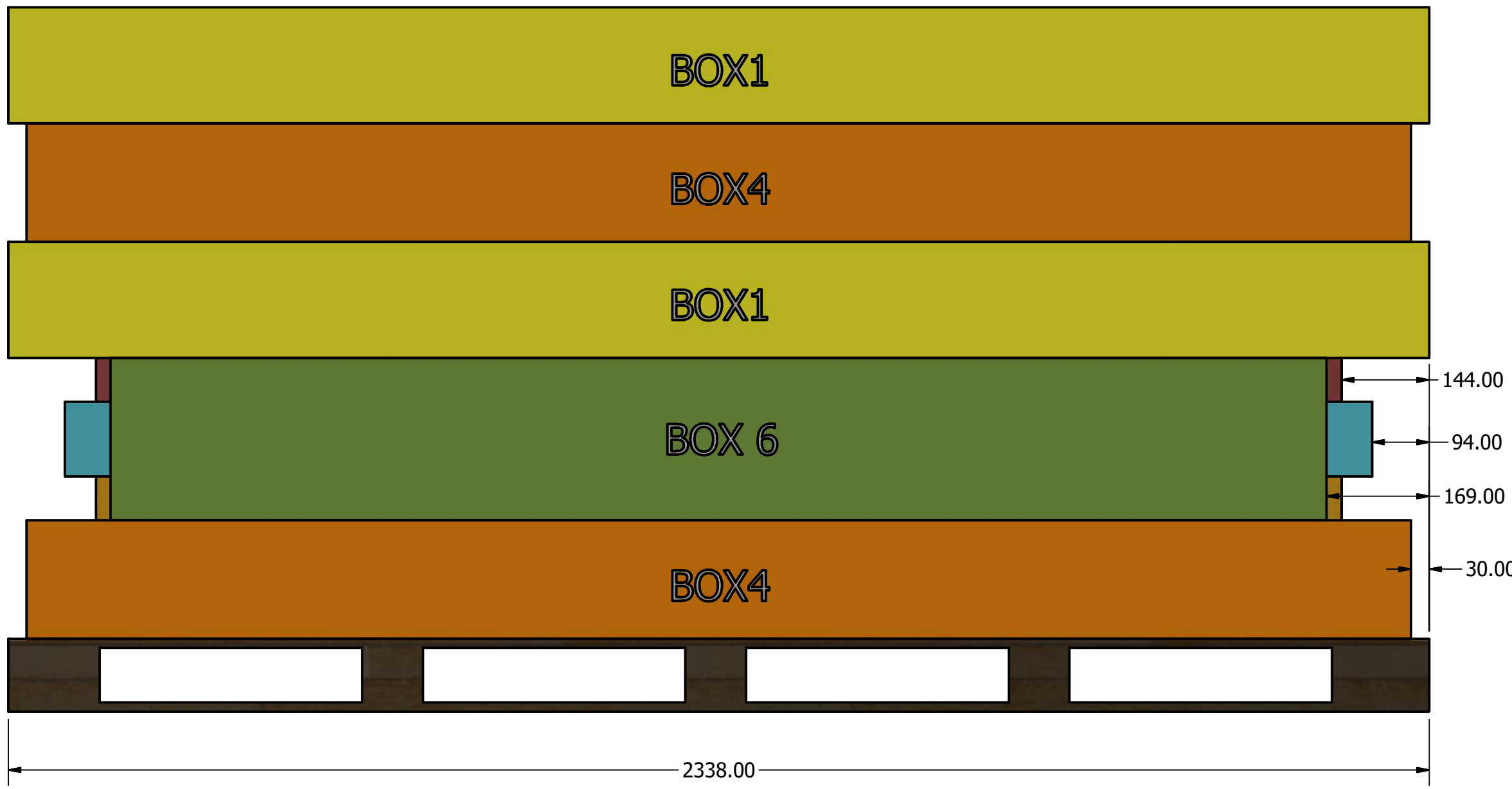
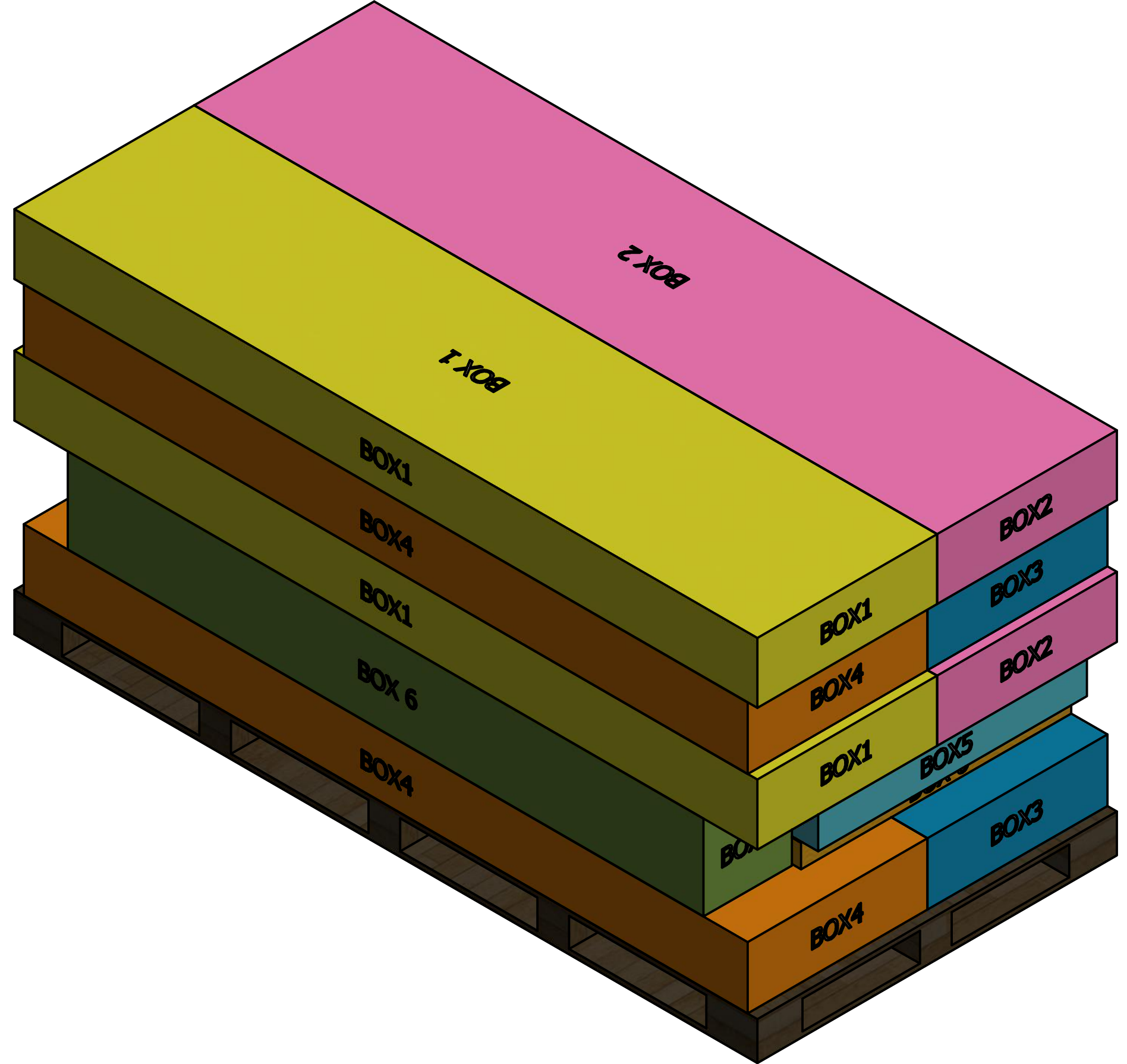

DRAWN	Rudy	2019/8/19		
CHECKED			TITLE	
QA				
MFG				
APPROVED				
			SIZE	DWG NO
			D	Pallet A
			SCALE	1: 8
			SHEET 1 OF 1	

Pallet C ( 1.5 sets/pallet )

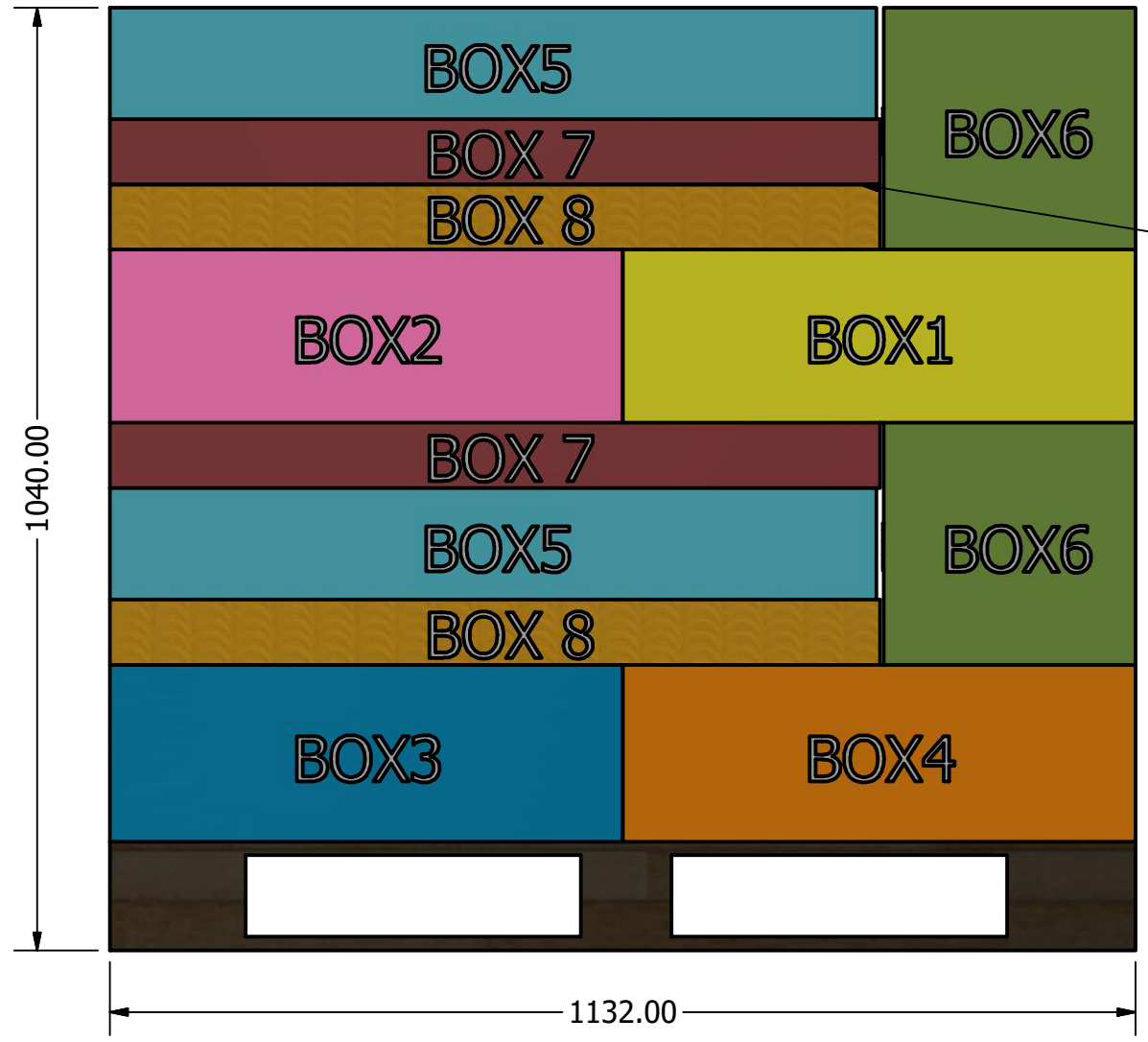
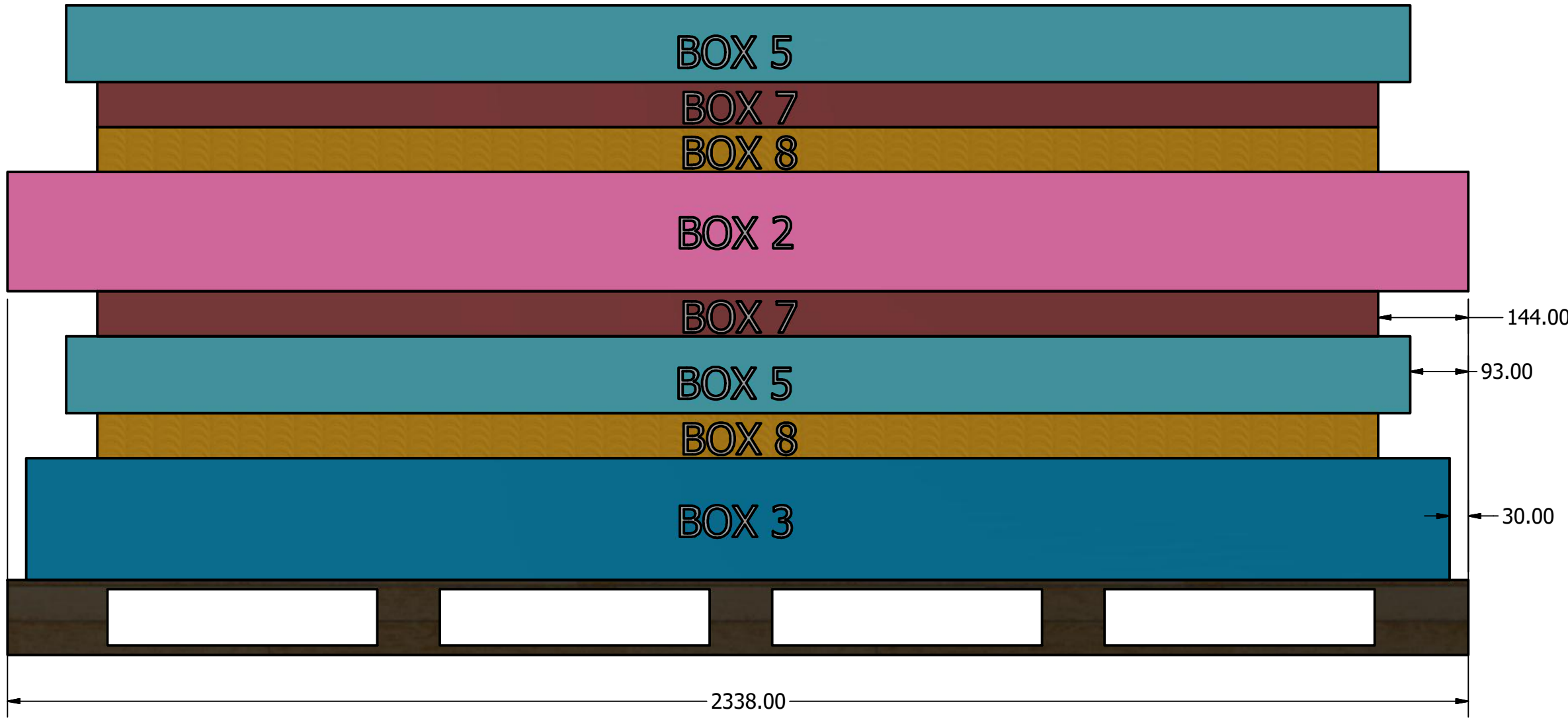
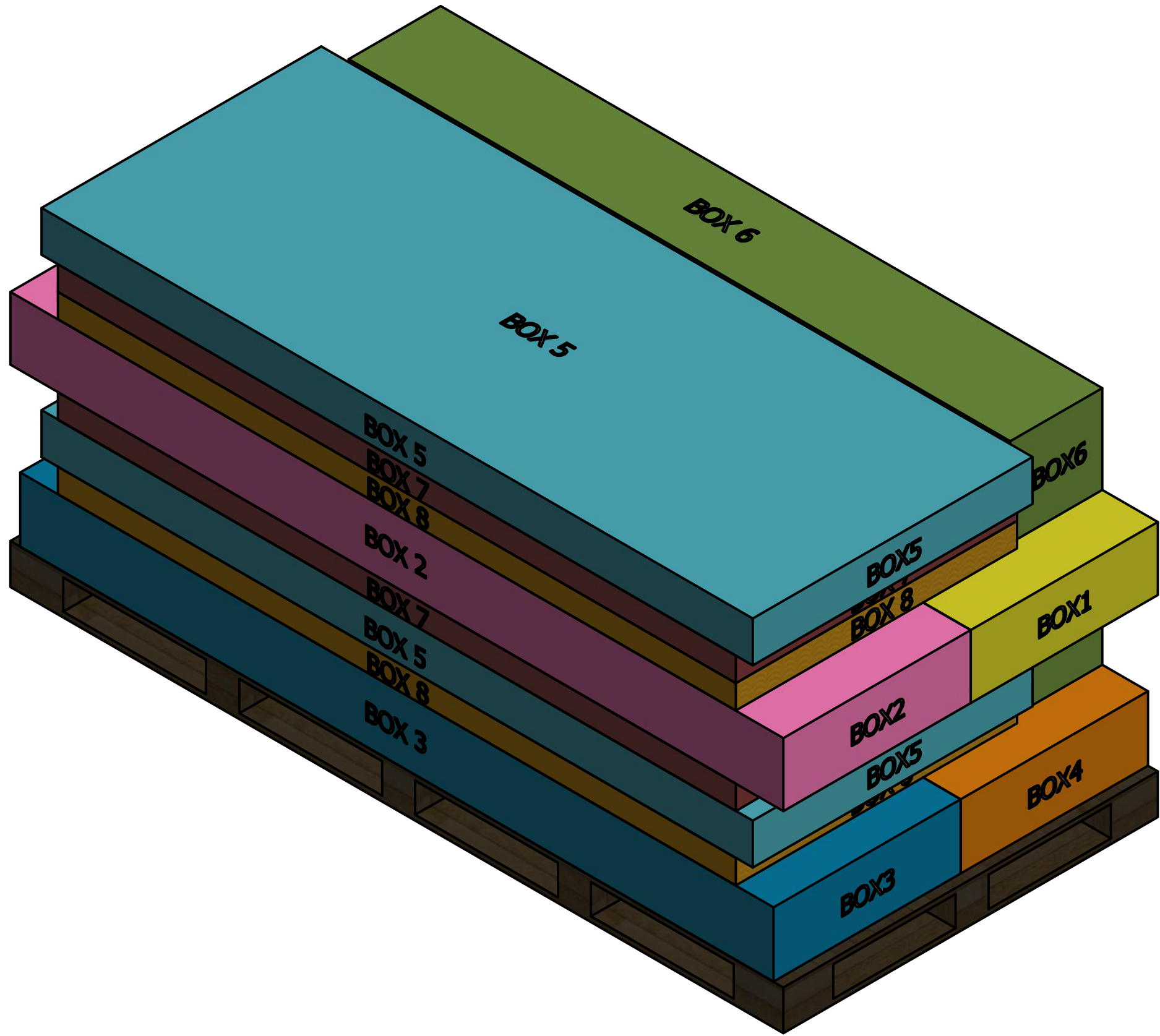
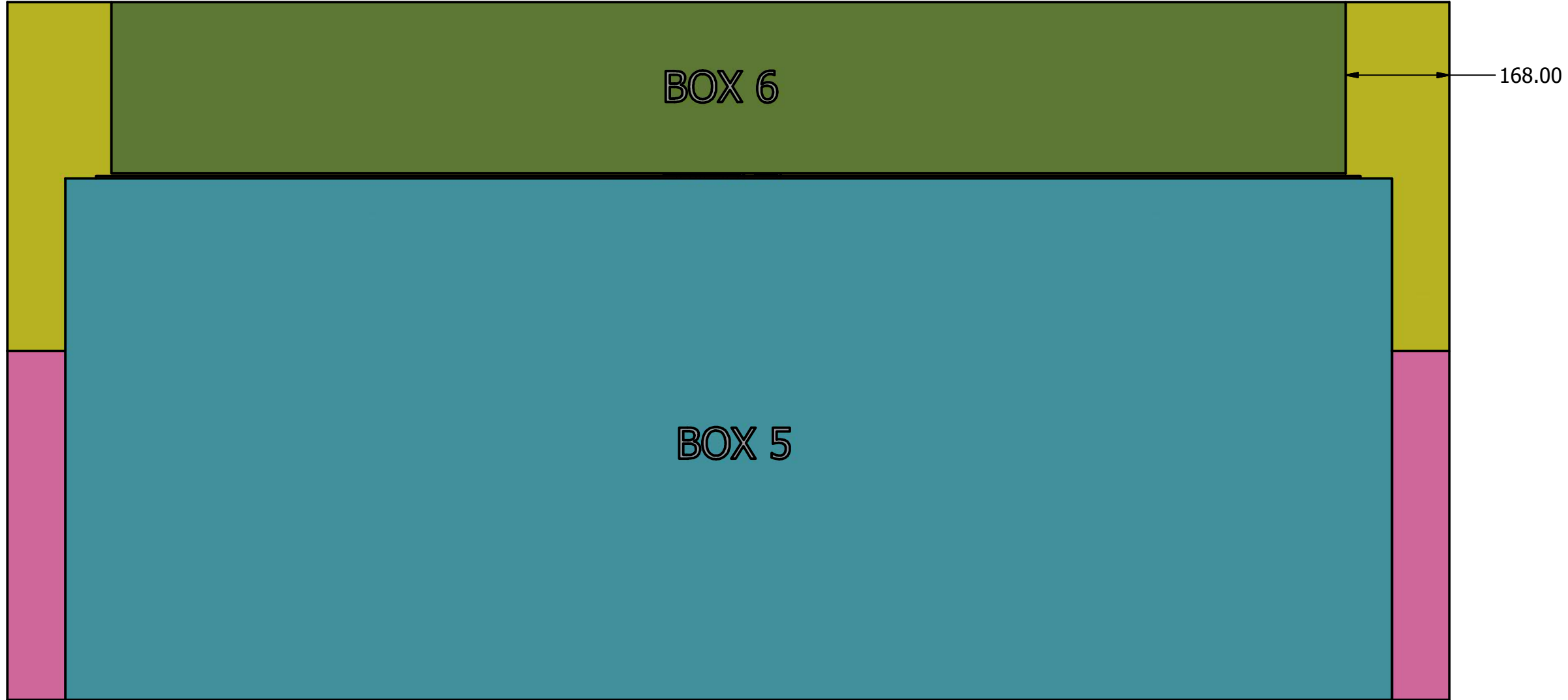

BOX7和BOX8堆叠好之后，需要用塑钢带在长度方向固定，避免两个铁棚盒在长度方向相互移动。

DRAWN Rudy	2019/8/19		
CHECKED		TITLE	
QA			
MFG			
APPROVED			
		SIZE D	DWG NO Pallet A
		SCALE 1 / 8	REV
		SHEET 1 OF 1	

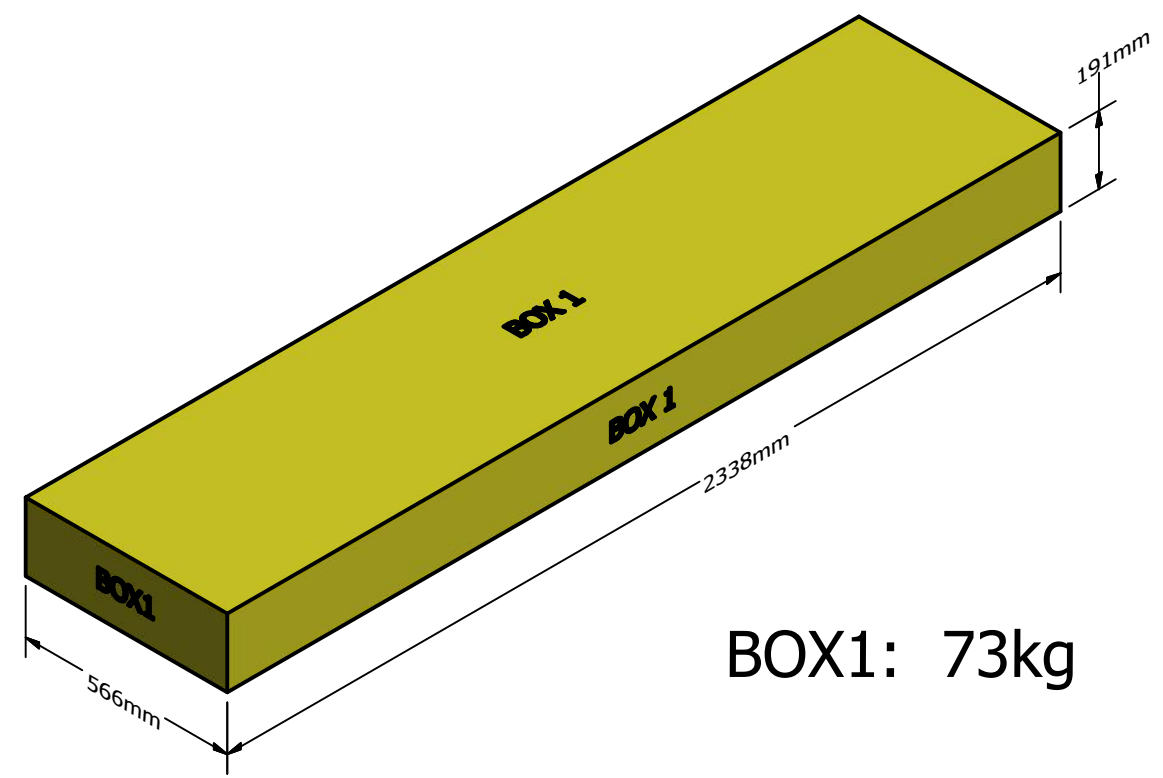

BOX1: 73kg

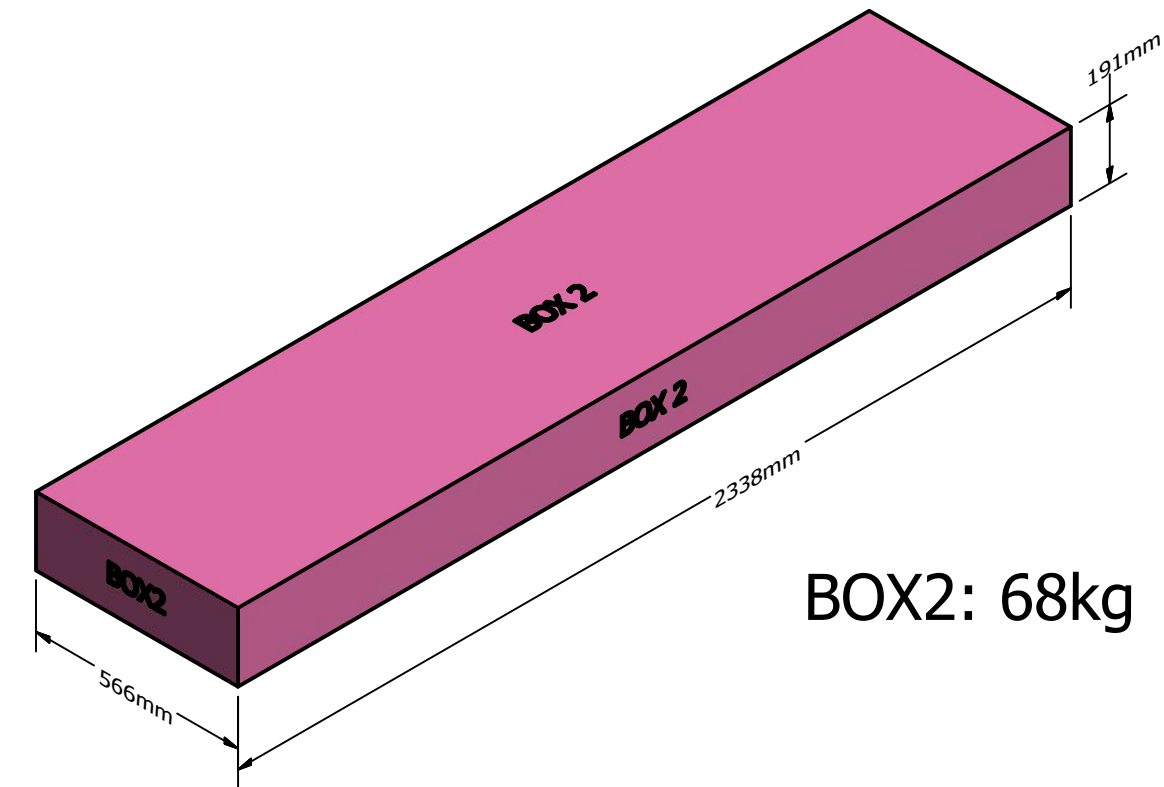

BOX2: 68kg

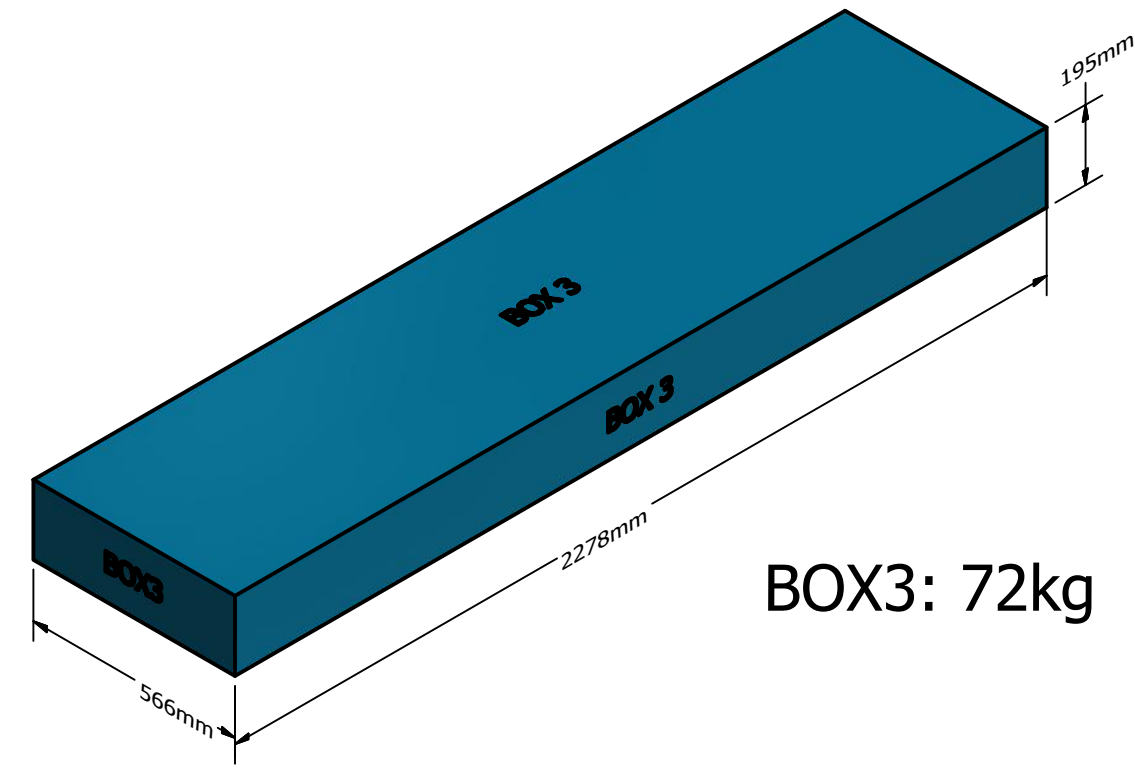

BOX3: 72kg

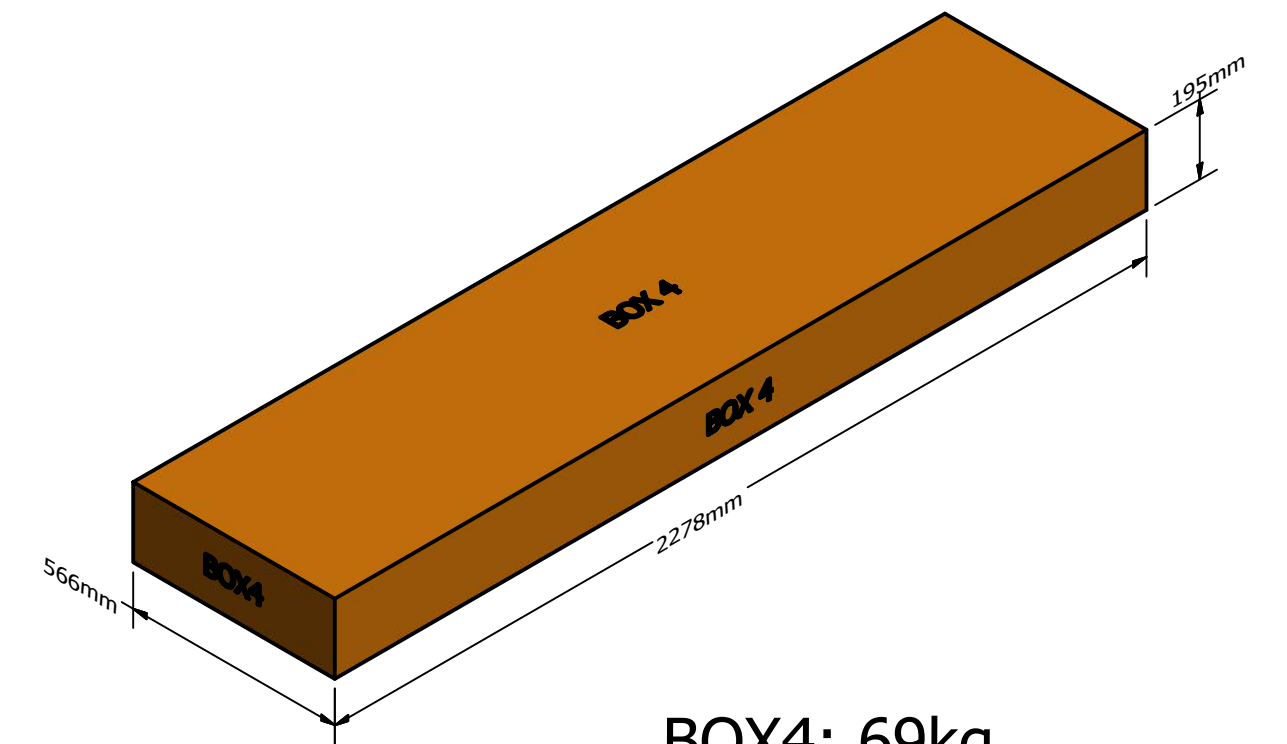

BOX4: 69kg

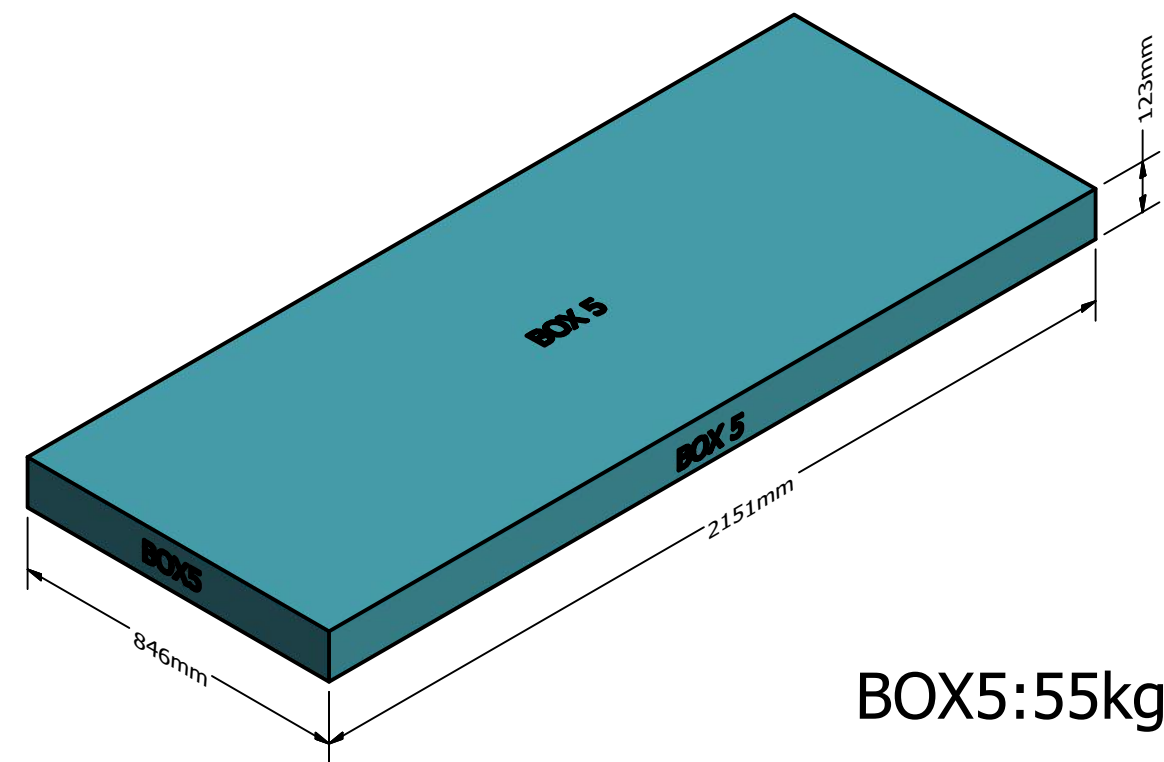

BOX5: 55kg

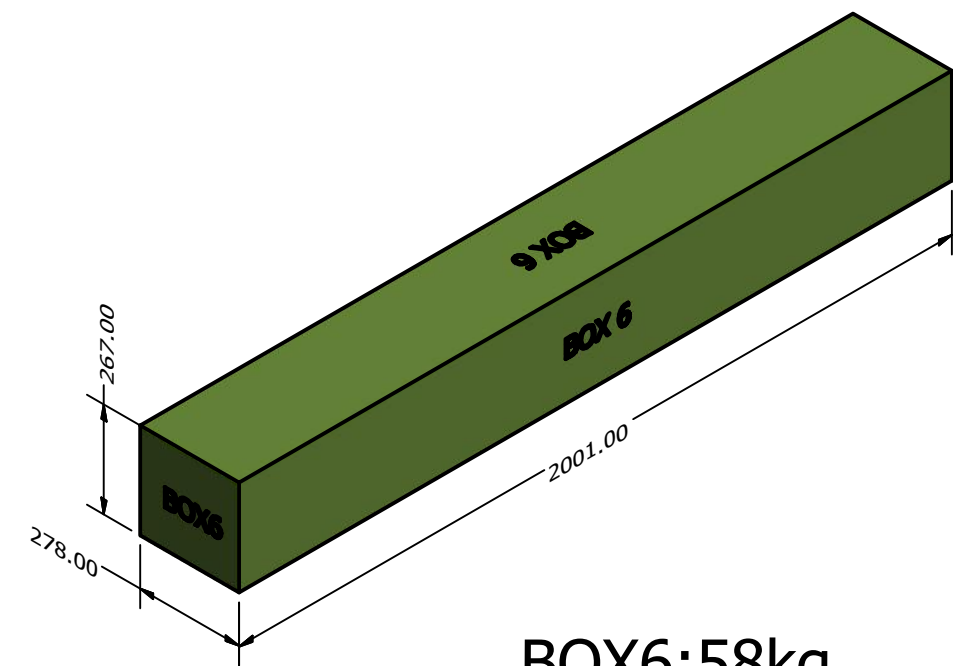

BOX6: 58kg

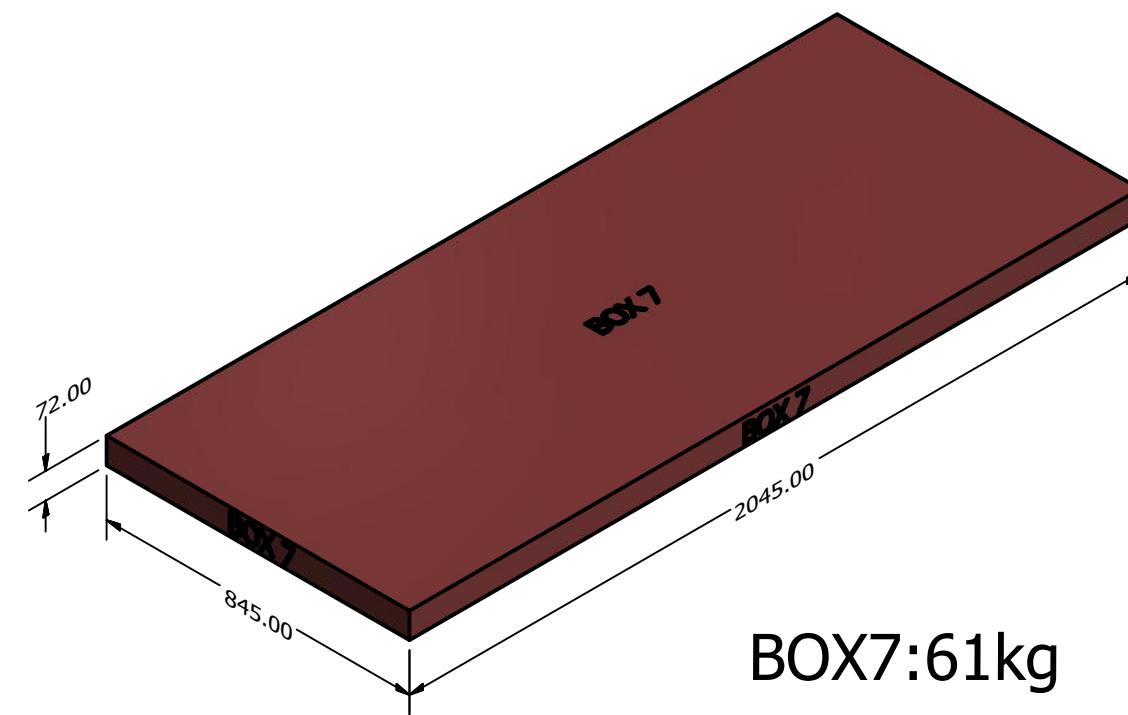

BOX7: 61kg

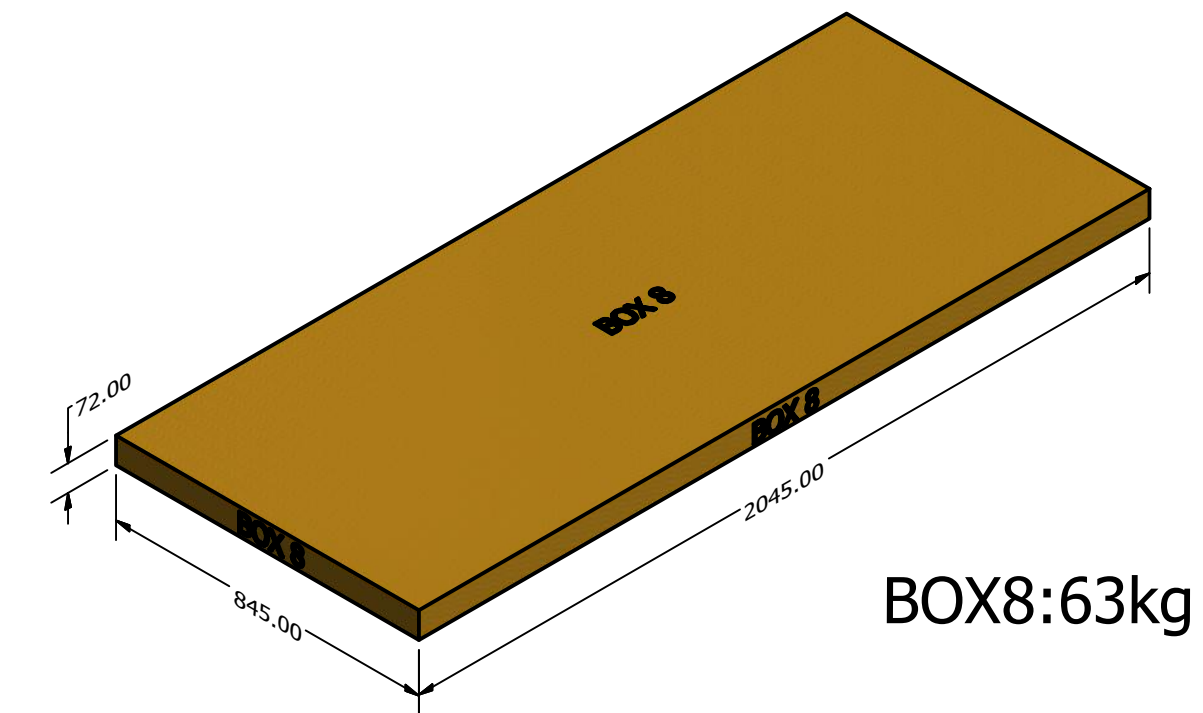

BOX8: 63kg

DRAWN Rudy	2019/8/19			
CHECKED		TITLE		
QA				
MFG				
APPROVED				
		SIZE D	DWG NO Pallet A (详细)	REV
		SCALE 1 / 15	SHEET 1 OF 1	