



The installation must only be performed by a licensed electrician.

To prevent death, injury or damage to property, this product must be installed in accordance to National Electrical Code (NFPA70) in the US or Canadian Electrical Code (CSA 22.1) in Canada.

Disconnect power before installing the product or servicing it.

Wait until fixture has cooled down before installing or servicing the fixture.

MIN. 90°C SUPPLY CONDUCTORS

What's In The Box

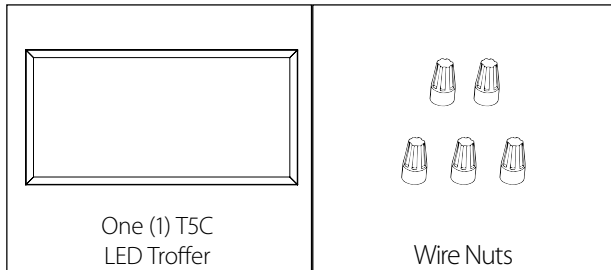

Tools Needed

This LED Troffer requires very few tools for installation. A drill or a screwdriver and a pair of wirecutter.



- 1** Carefully unpack the fixture from its packaging. Inspect product for defects due to shipping.

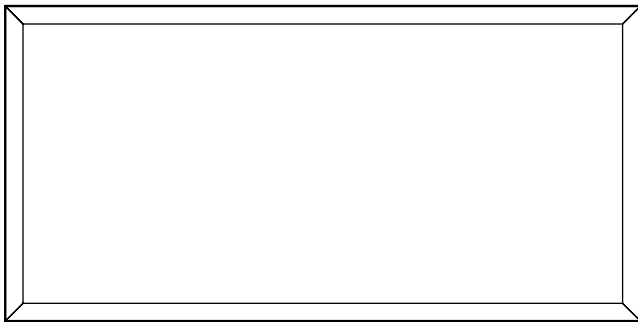

- 2** Locate desired positioning for fixture in ceiling grid. Remove ceiling tiles if necessary.

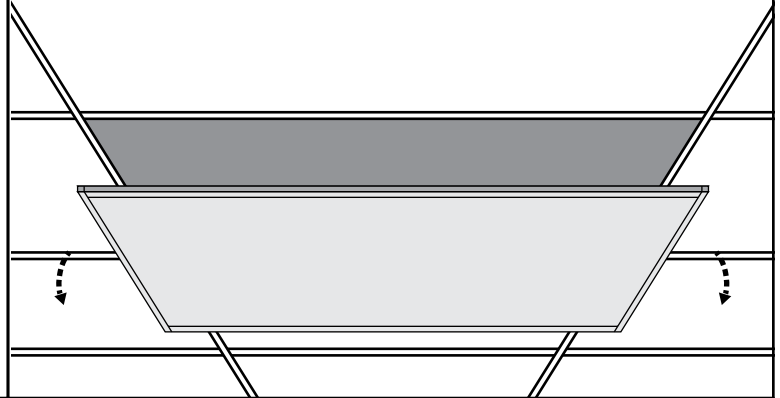

- 3** Turn off power to appropriate circuit at the breaker panel.

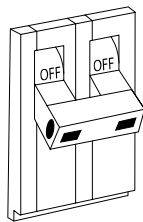

- 4** Place fixture into the T-grid ceiling panel. Secure to structure and/or grid per state and local codes.

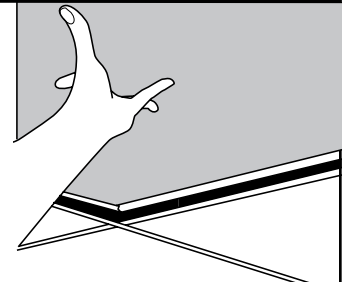

- 5 Remove access plate from junction-box (do not discard) by removing screws.
Other end is for low voltage connection.

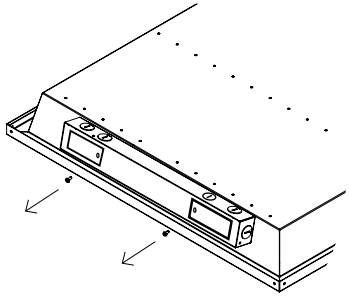

- 6 Connect wiring as shown. Grey and purple wiring are for 0-10V dimming systems. Cap off if not used.

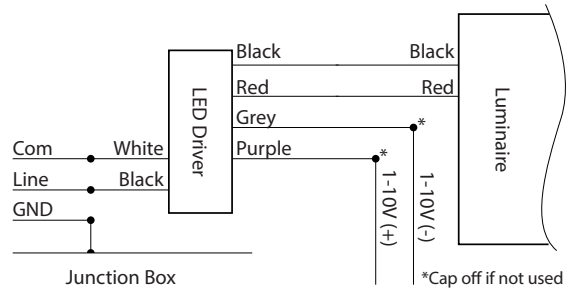

- 7 Reattach cover of junction box and secure with (2) two screws.

- 8 Turn power on and verify that the panel is lit.