

Features

- Quarter-turn washerless ceramic disc valves

Material

- Premium metal construction for durability and reliability
- Brass valve bodies

Installation

- For 8" – 16" (203 – 406 mm) centers

Required Products/Accessories

K-72759 Bathroom sink faucet spout with Bell design, 1.2 gpm

or

K-72760 Bathroom sink faucet spout with Column design, 1.2 gpm

or

K-72761 Bathroom sink faucet spout with Flume design, 1.2 gpm

Recommended Products/Accessories

- K-72567 18" Towel Bar
- K-72568 24" Towel Bar
- K-72570 24" Double Towel Bar
- K-72571 Towel Ring
- K-72572 Robe Hook
- K-72573 Pivoting toilet paper holder
- K-72576 Toilet paper carriage



ADA

Codes/Standards









ASME A112.18.1/CSA B125.1
NSF/ANSI/CAN 61
NSF/ANSI/CAN 372
ADA
ICC/ANSI A117.1

KOHLER® Faucet Lifetime Limited Warranty

See website for detailed warranty information.

Available Colors/Finishes

Color tiles intended for reference only.

Color	Code	Description
	CP	Polished Chrome
	SN	Vibrant® Polished Nickel
	AF	Vibrant® French Gold
	BN	Vibrant® Brushed Nickel
	BV	Vibrant® Brushed Bronze
	BL	Matte Black
	2MB	Vibrant® Brushed Moderne Brass
	TT	Vibrant Titanium

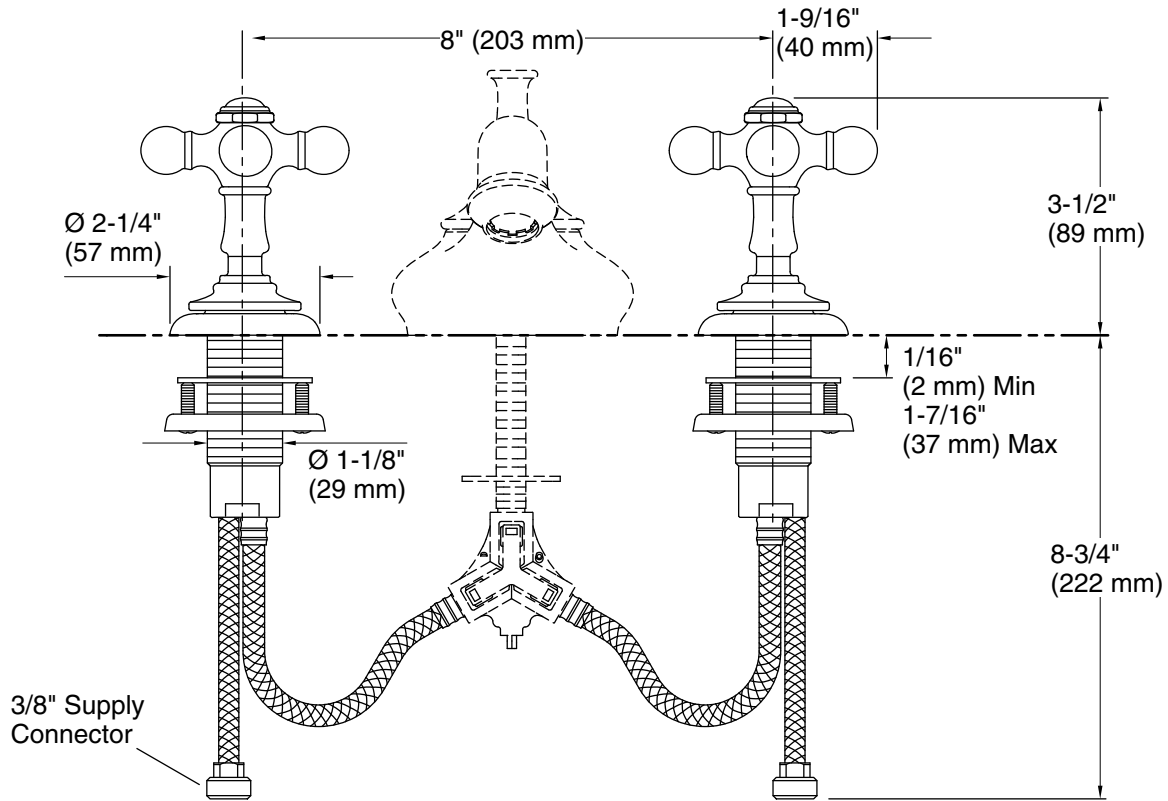

Technical Information

All product dimensions are nominal.

Spout:

Notes

Install this product according to the installation instructions.

ADA compliant for handles only.

ADA compliant when installed to the specific requirements of these regulations.