

2400382 ADVENTURER Container Loading Diagram

(1 set = 3 boxes, 25 pallets/40HQ, 54 sets/40HQ, Gross Weight:12384kg)

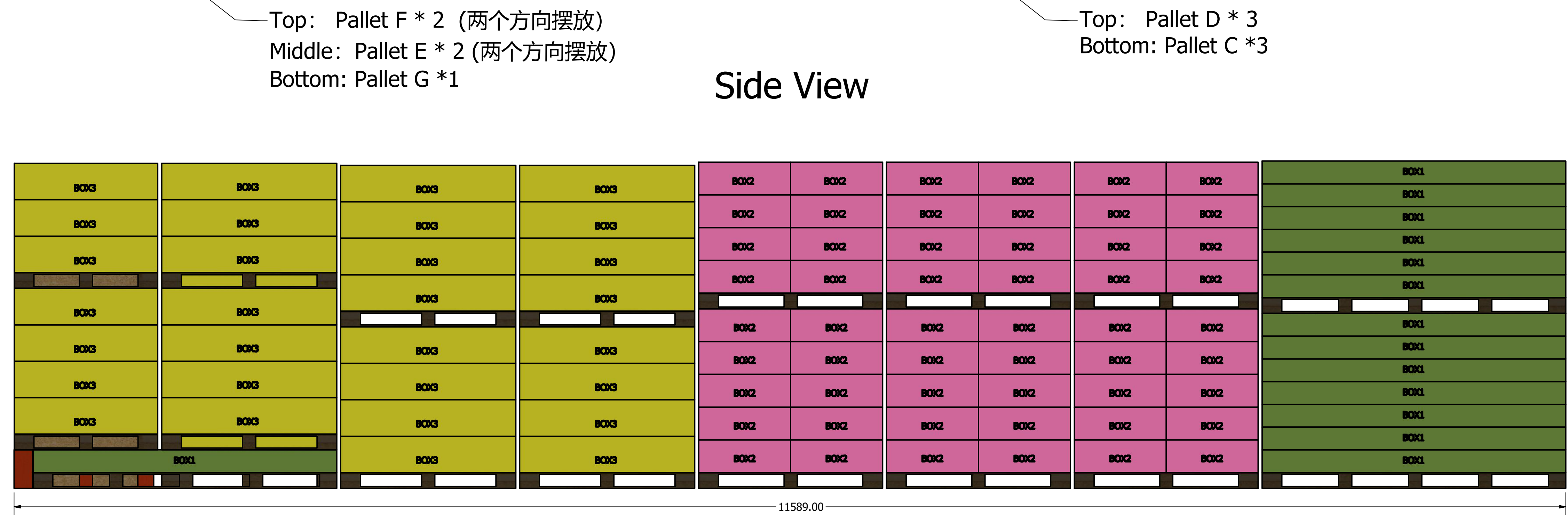
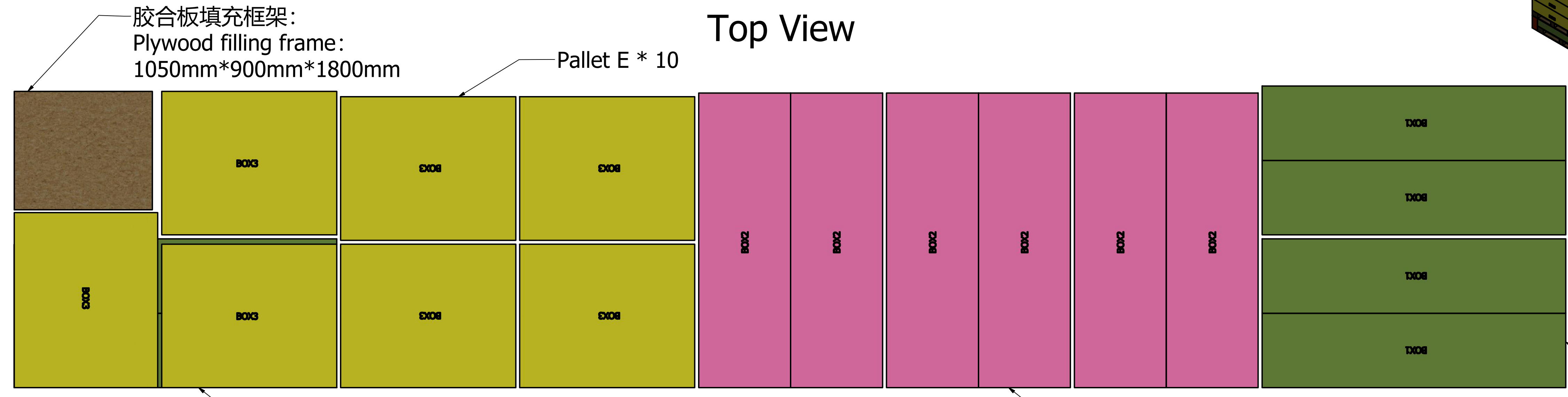
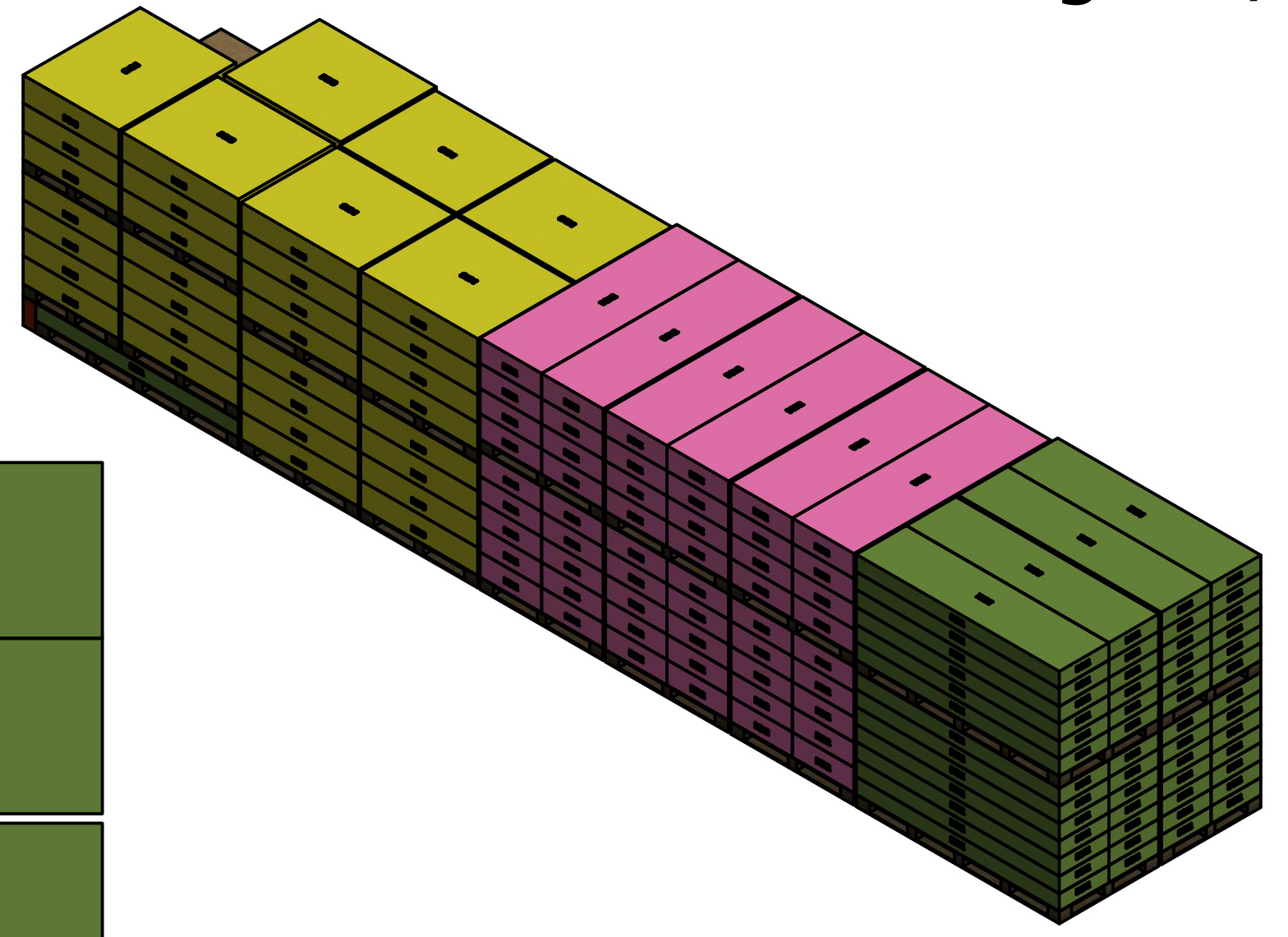

Top: Pallet B * 2
Bottom: Pallet A * 2

End View

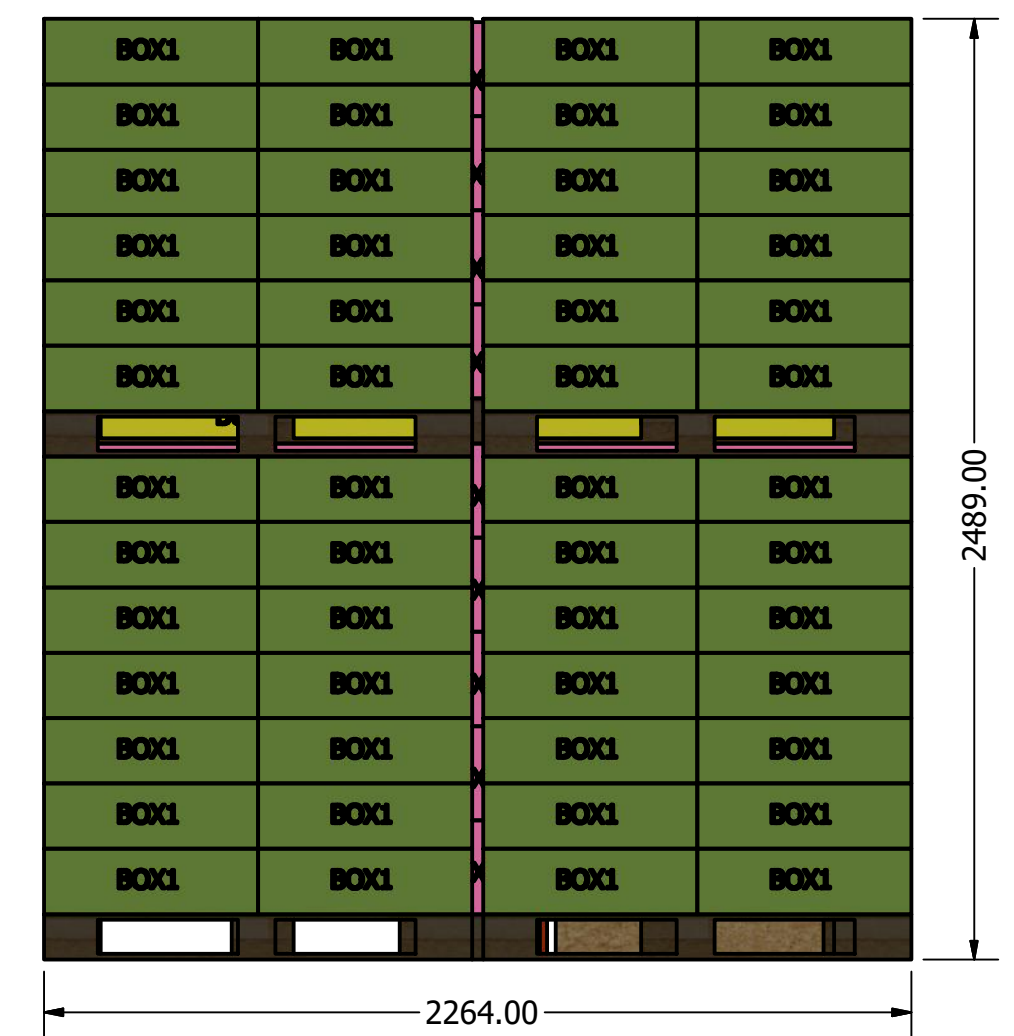

Total: Pallet A * 2
Pallet B * 2
Pallet C * 3
Pallet D * 3
Pallet E * 12
Pallet F * 2
Pallet G * 1

DRAWN Rudy		TITLE		
CHECKED				
QA				
MFG				
APPROVED				
		SIZE D	DWG NO	REV
		SCALE 1 / 20	SHEET 1 OF 1	

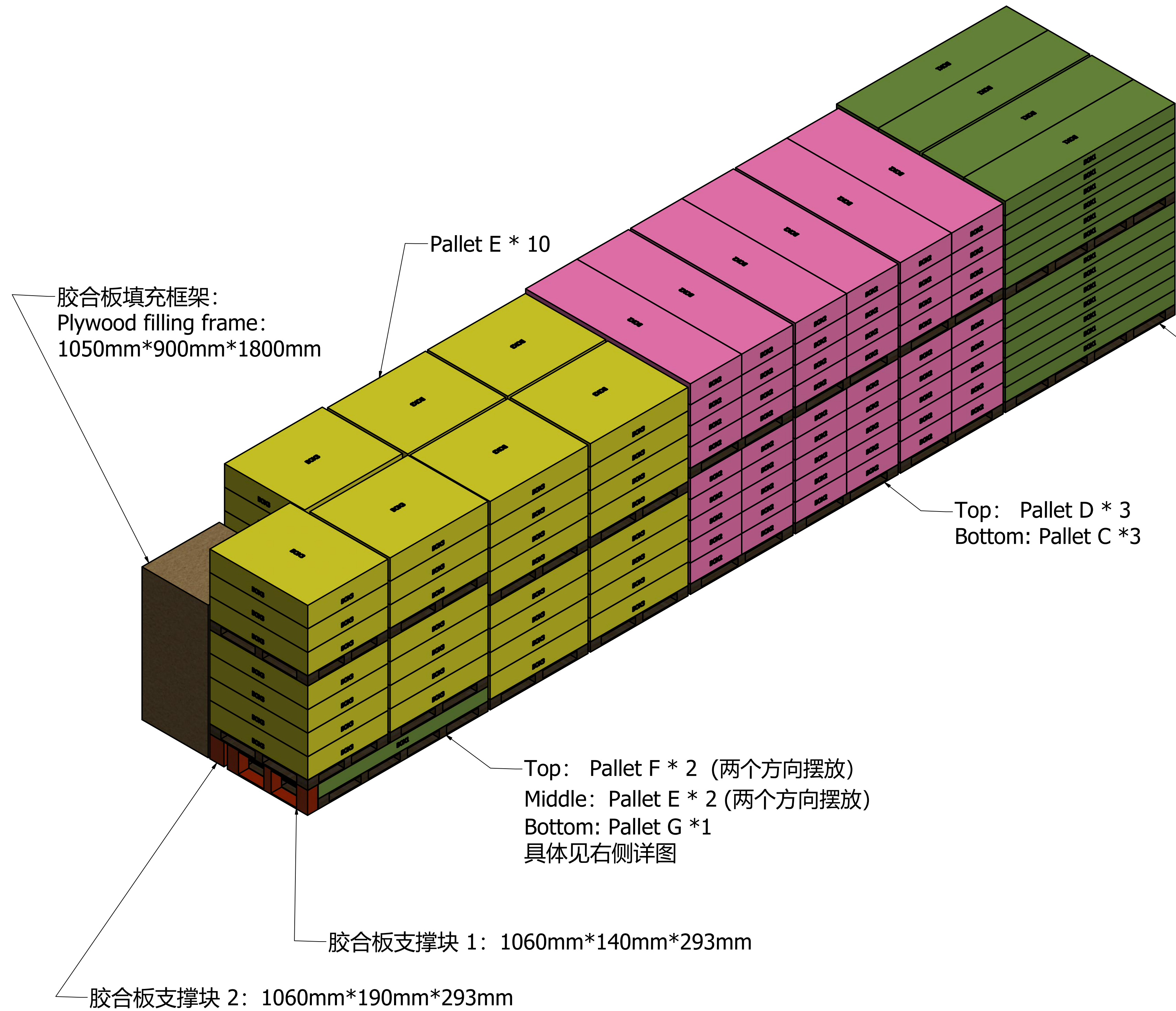

Top: Pallet B * 2
Bottom: Pallet A * 2

Top: Pallet F * 1
Middle: Pallet E * 1

Pallet G * 1

Top: Pallet F * 1
Middle: Pallet E * 1

胶合板支撑块 2: 1060mm*190mm*293mm

胶合板支撑块 1: 1060mm*140mm*293mm

注意: 堆叠好之后, 需要使用塑钢带将Pallet G, 两个胶合板支撑块, 以及Pallet E和Pallet F固定起来.

Total: Pallet A * 2 Pallet B * 2
Pallet C * 3 Pallet D * 3
Pallet E * 12 Pallet F * 2
Pallet G * 1

DRAWN Rudy	2021-5-11	TITLE		
CHECKED		TITLE		
QA		TITLE		
MFG		TITLE		
APPROVED		TITLE		
		SIZE D	DWG NO	REV
		SCALE 1 : 25	SHEET 1 OF 1	

Pallet A
(BOX1*14)

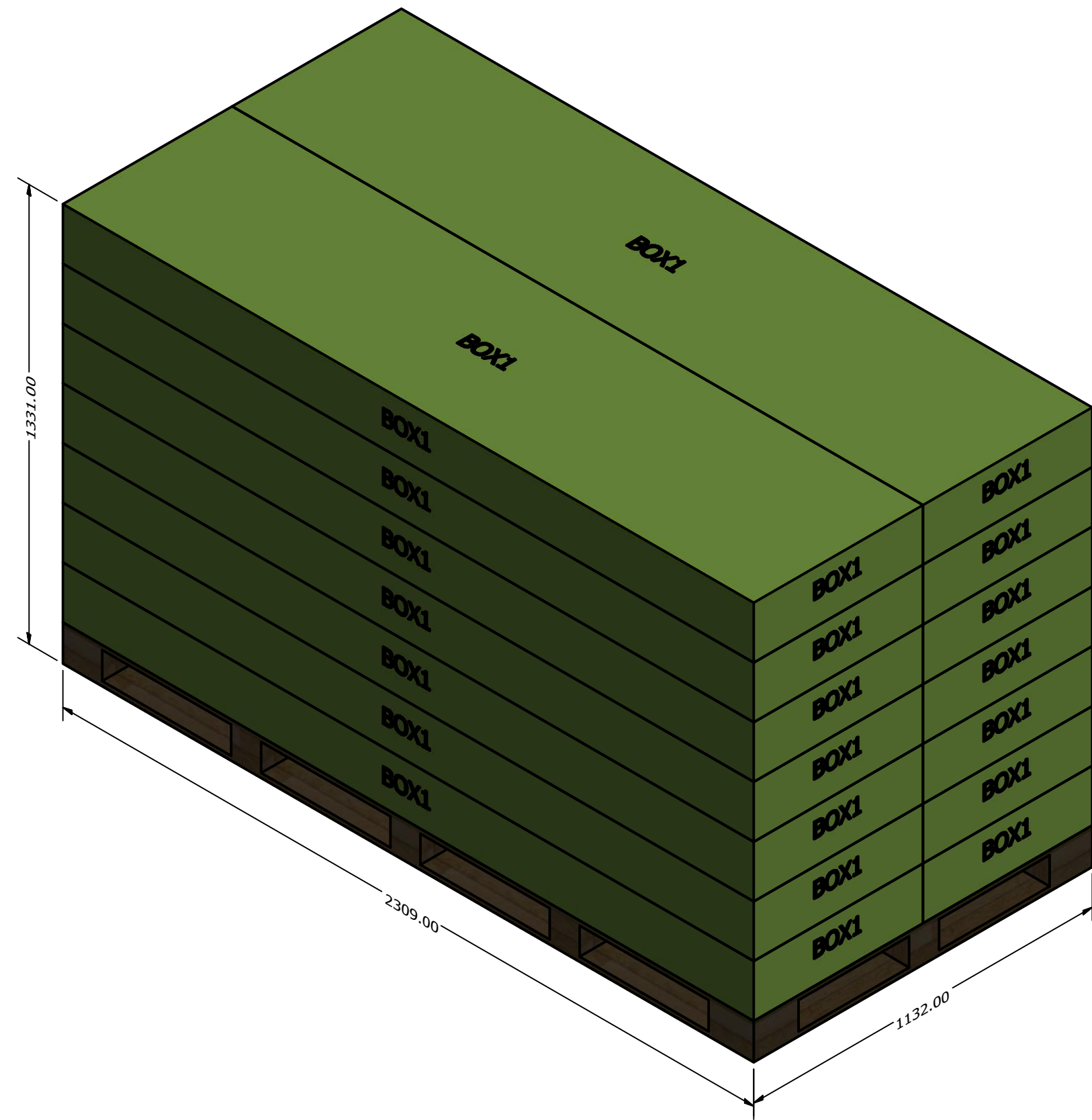

Pallet B
(BOX1*12)

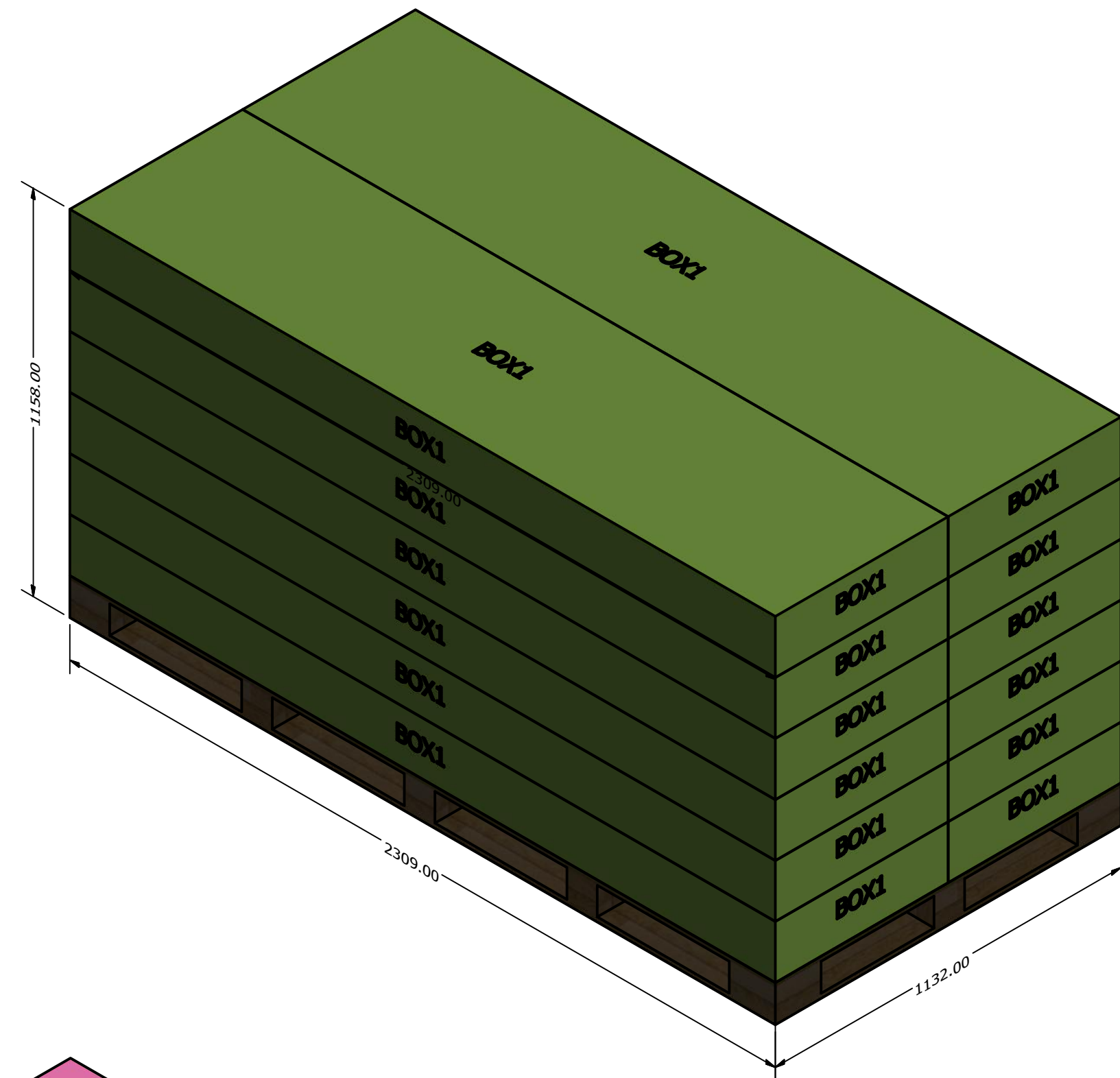

Pallet C
(BOX2*10)

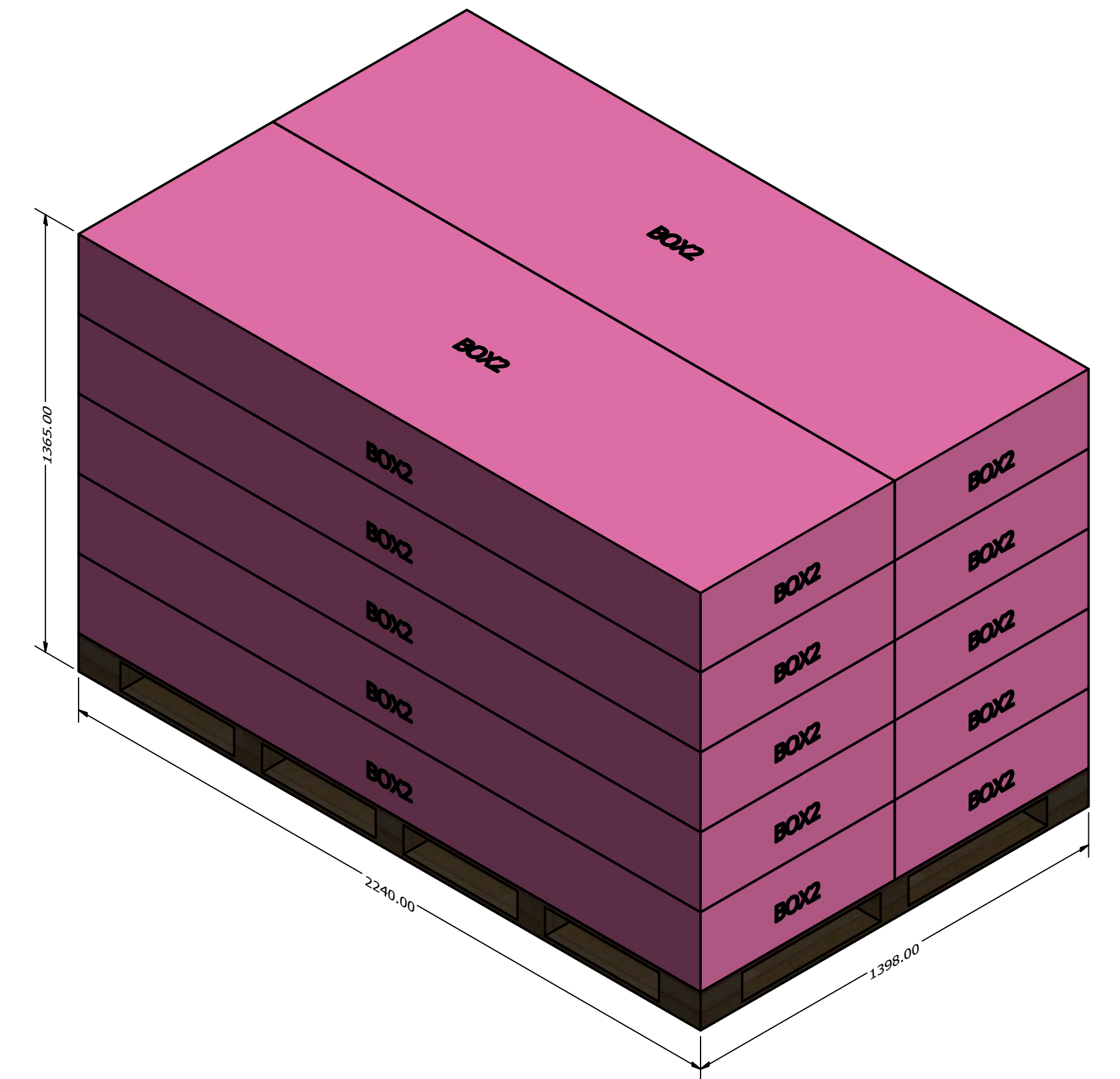

Pallet D
(BOX2*8)

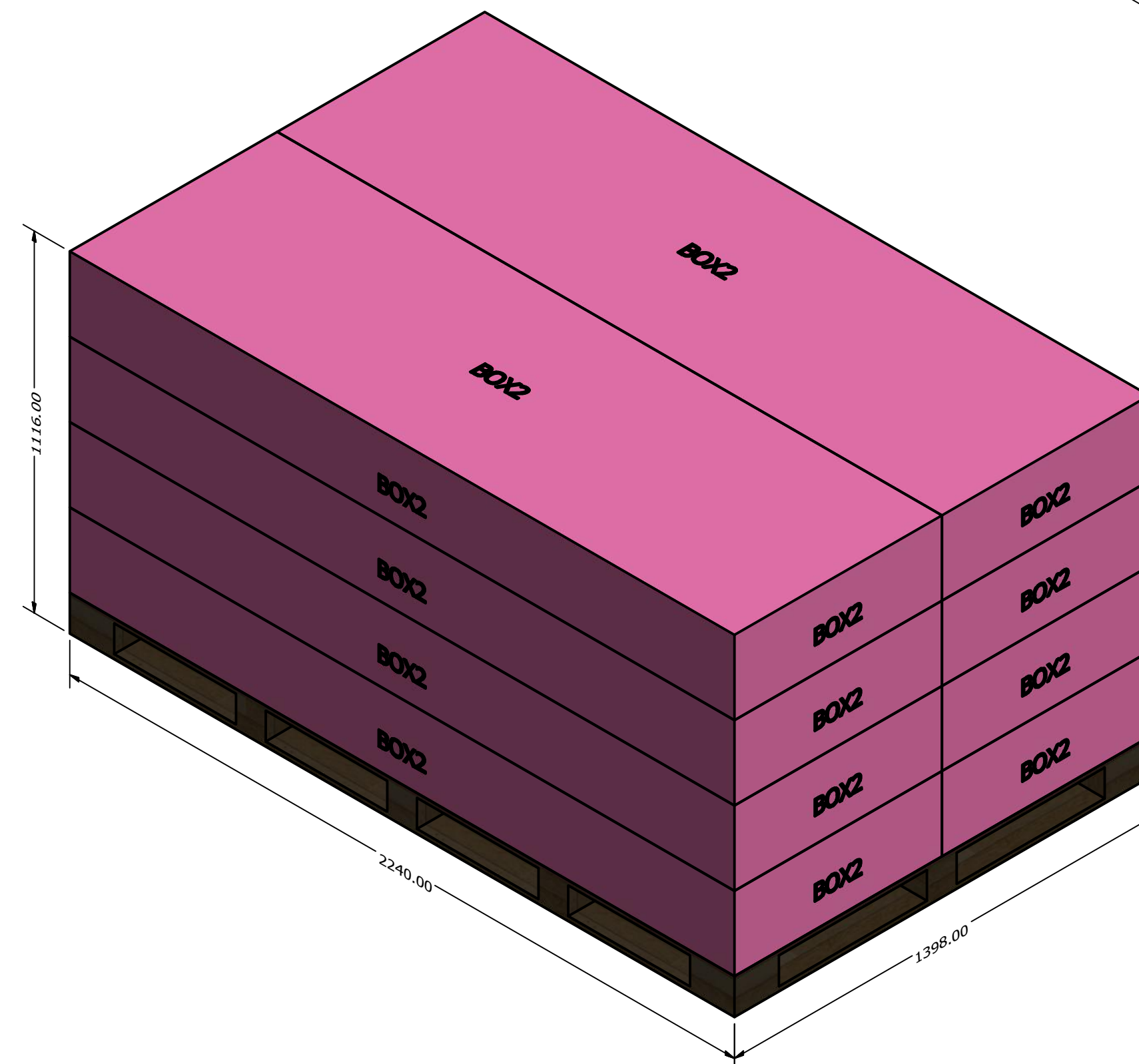

DRAWN	Rudy	2021-5-11			
CHECKED			TITLE		
QA					
MFG					
APPROVED					
			SIZE	DWG NO	REV
			D		
			SCALE	1: 12	SHEET 1 OF 1

Pallet E
(BOX3*4)

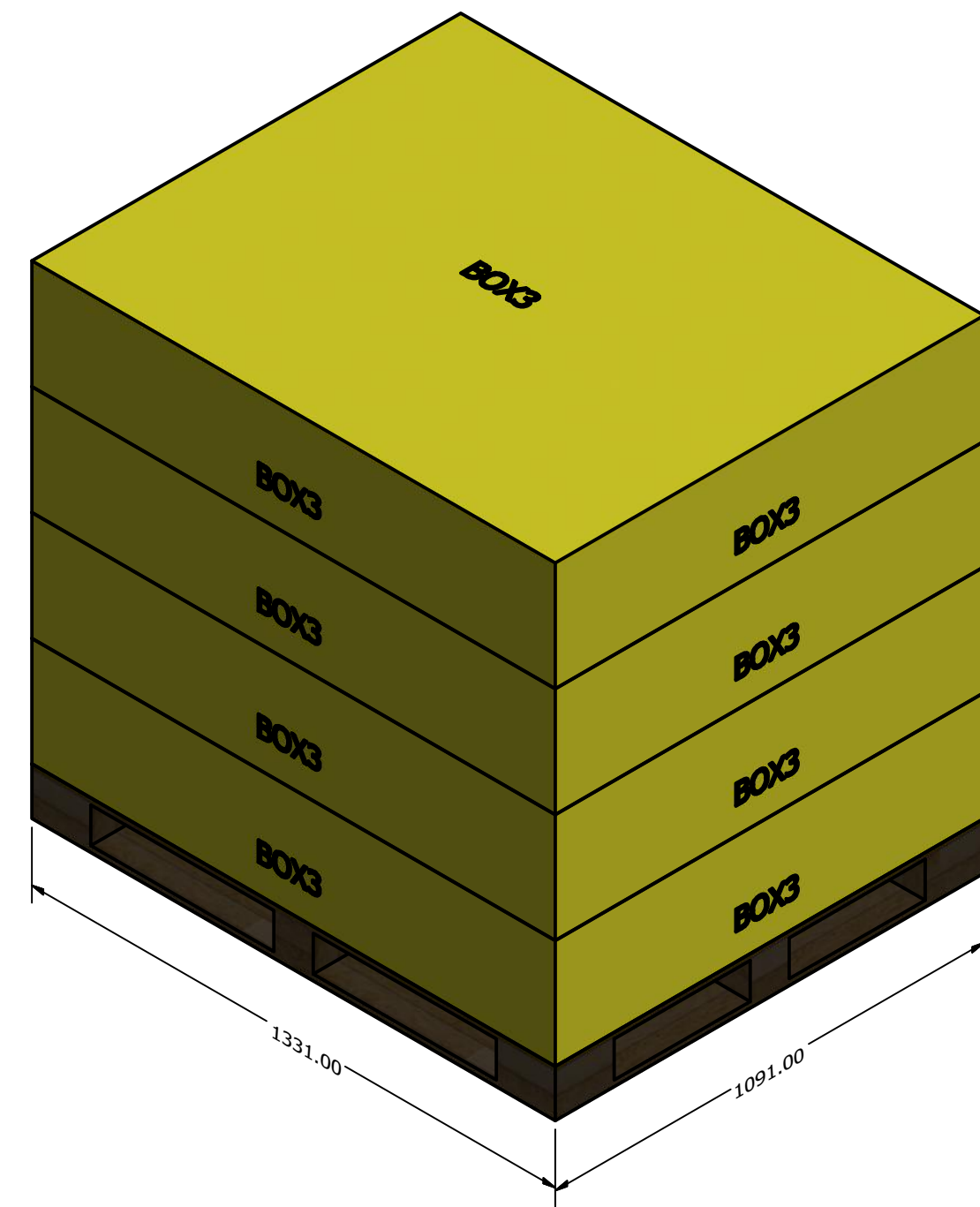

Pallet F
(BOX3*3)

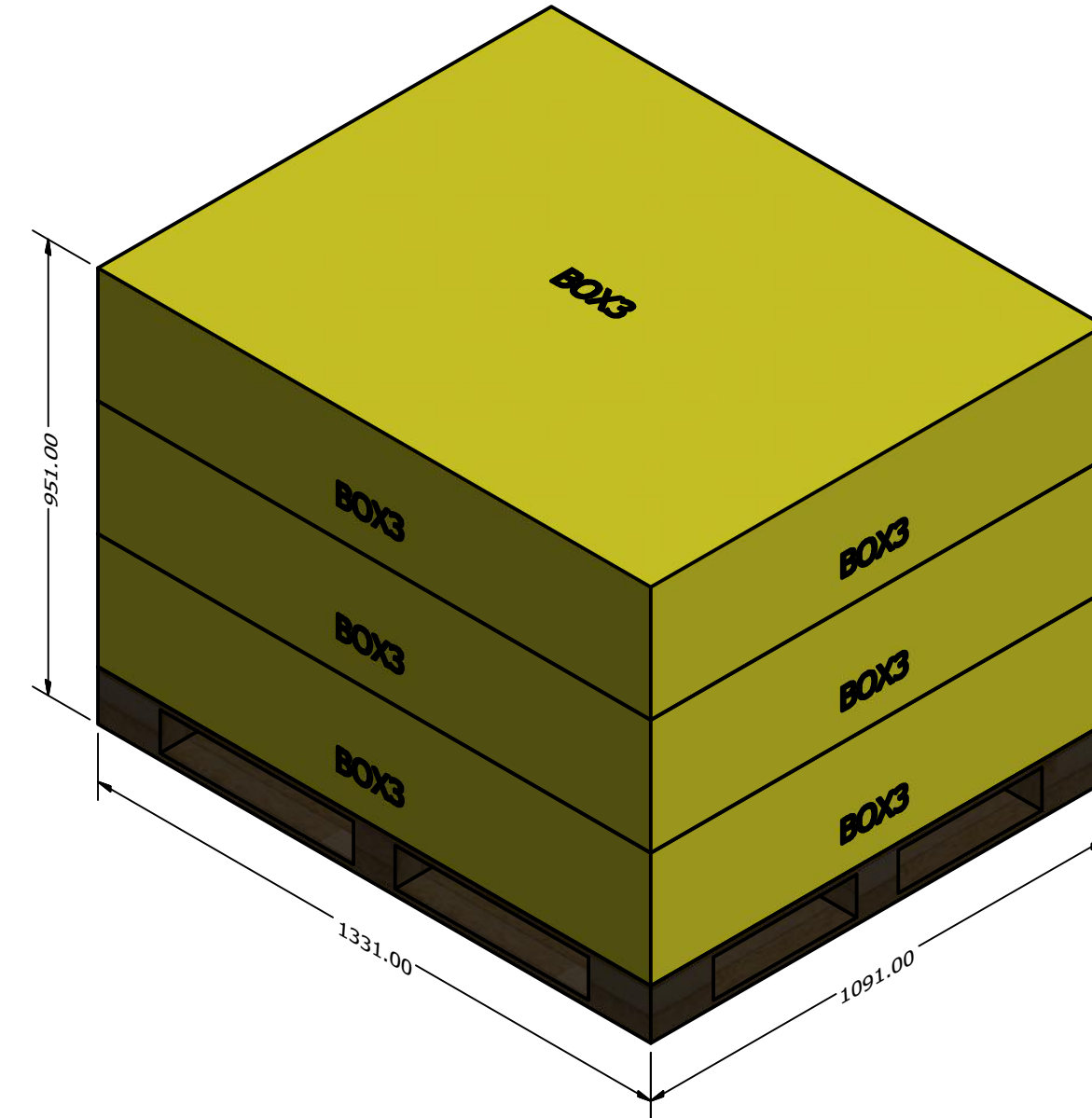

Pallet G
(BOX1*2)

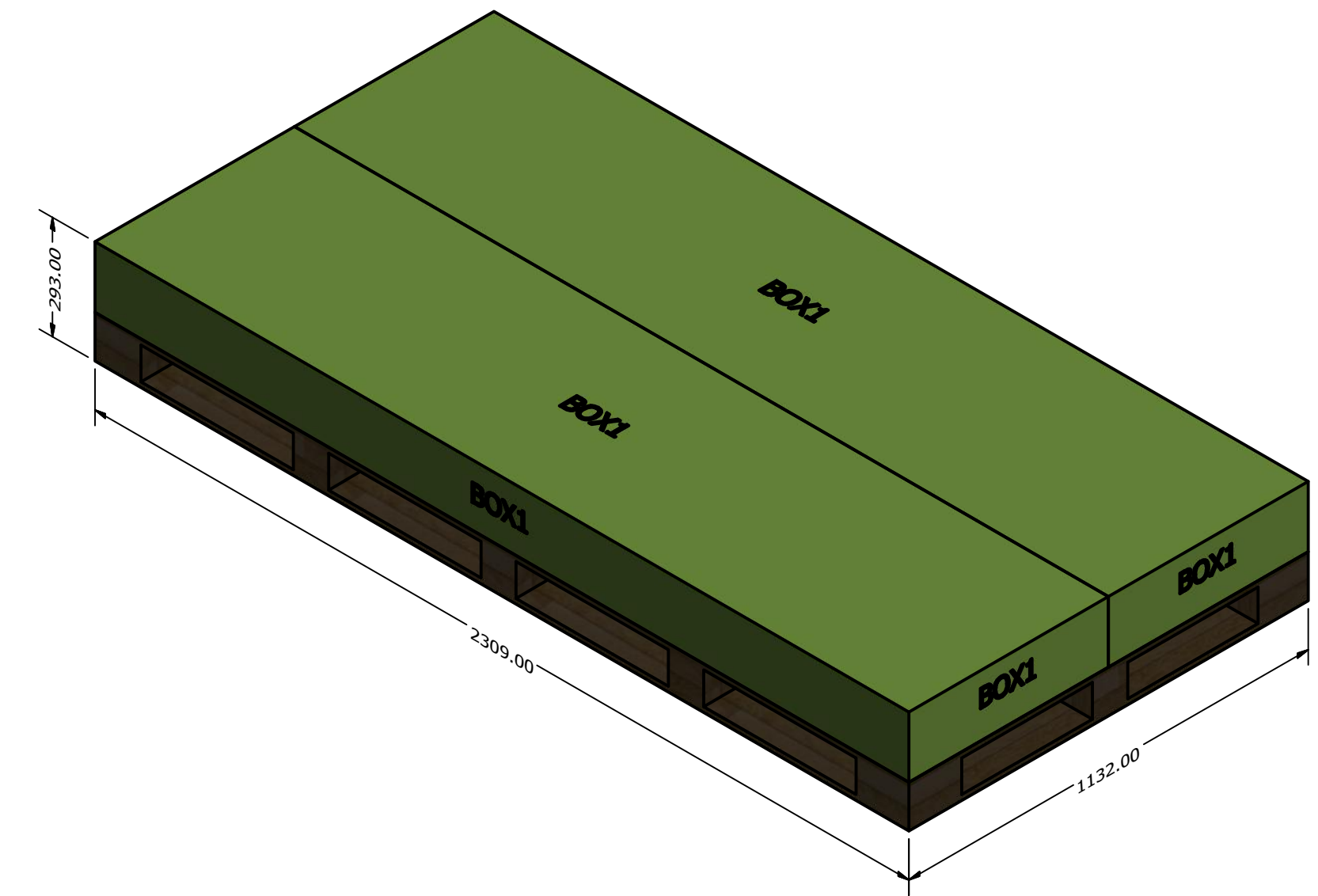

DRAWN	Rudy	2021-5-11			
CHECKED			TITLE		
QA					
MFG					
APPROVED					
			SIZE	DWG NO	REV
			D		
			SCALE	SHEET 1 OF 1	
			1 : 12		

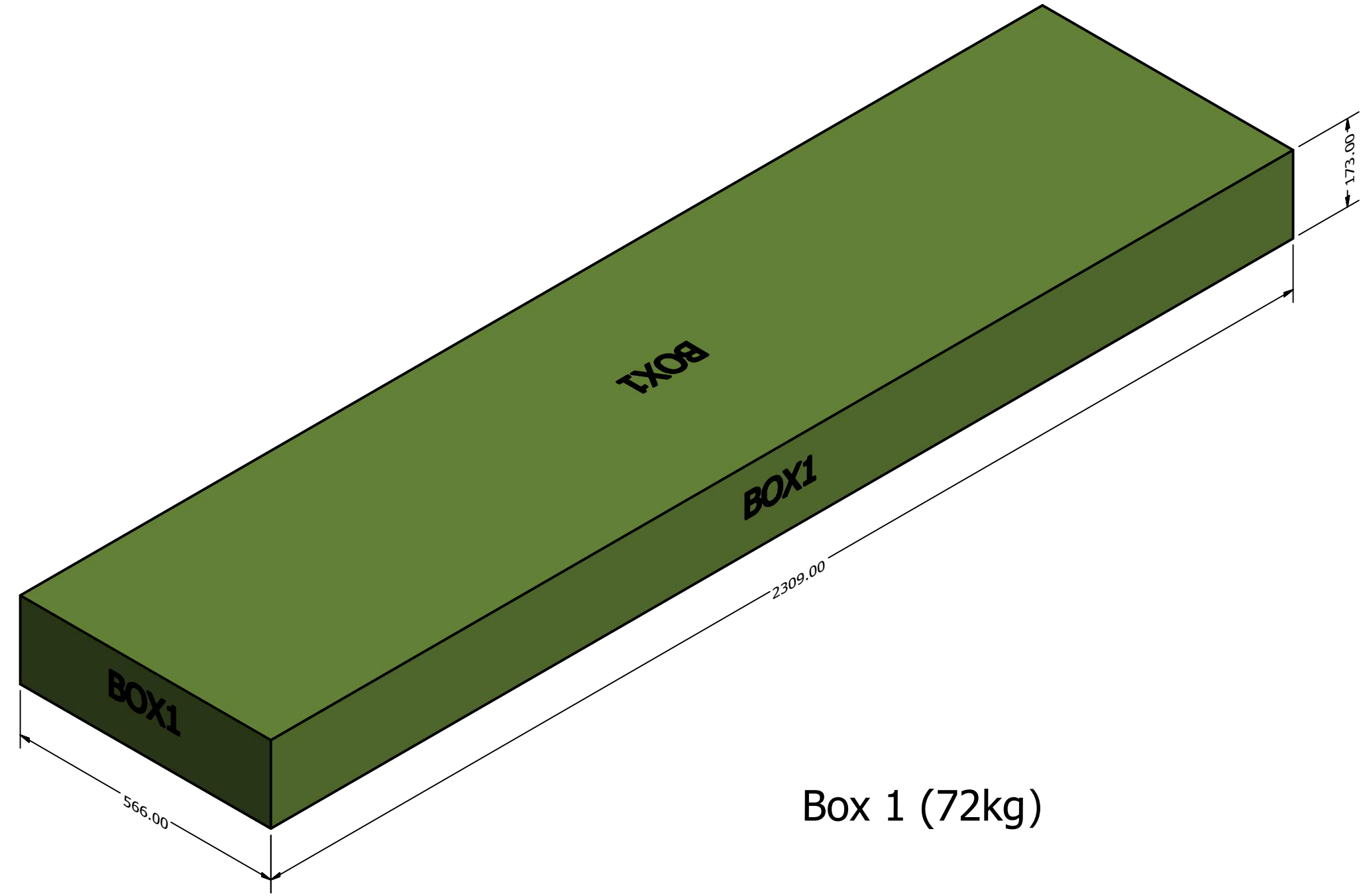

Box 1 (72kg)

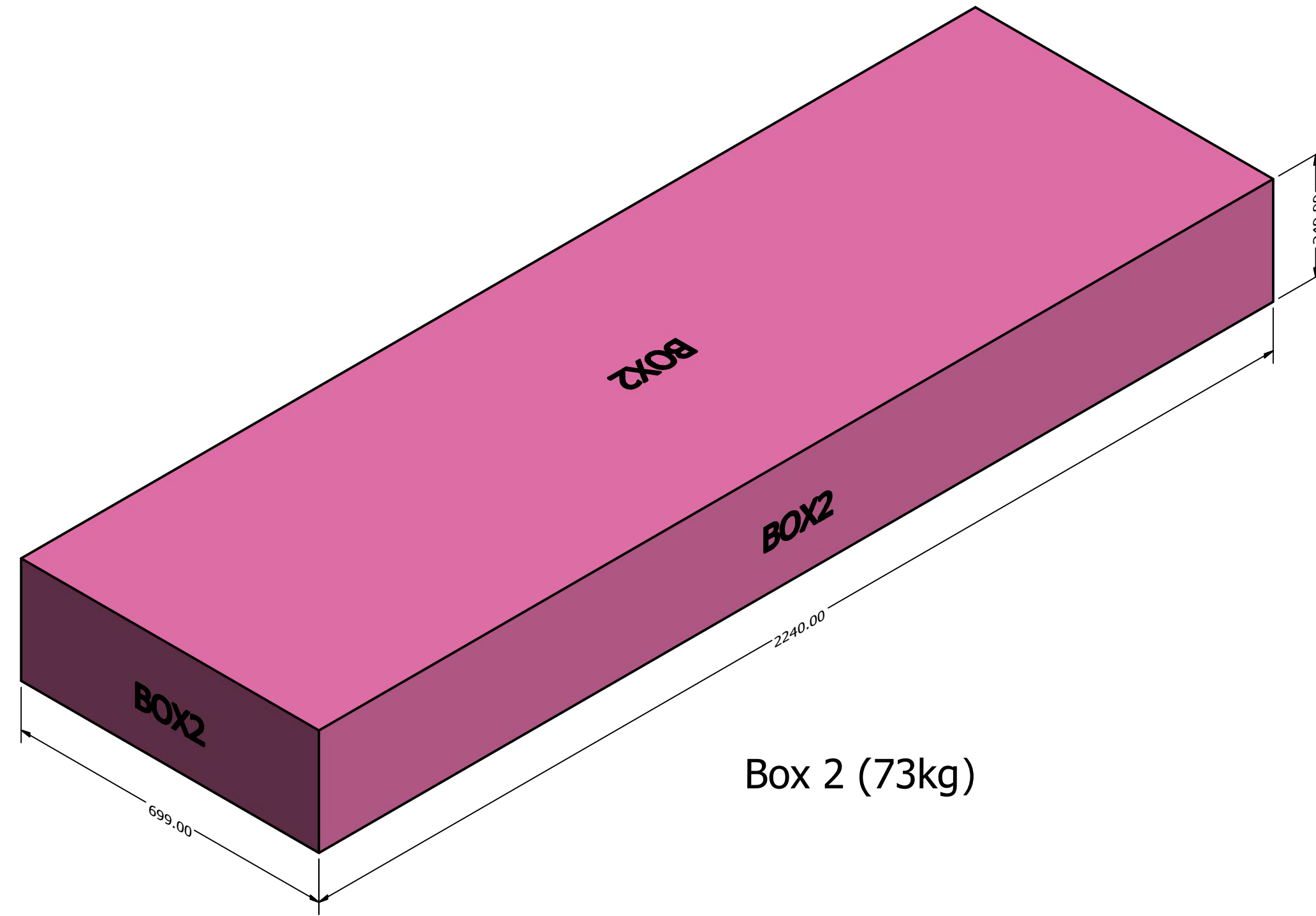

Box 2 (73kg)

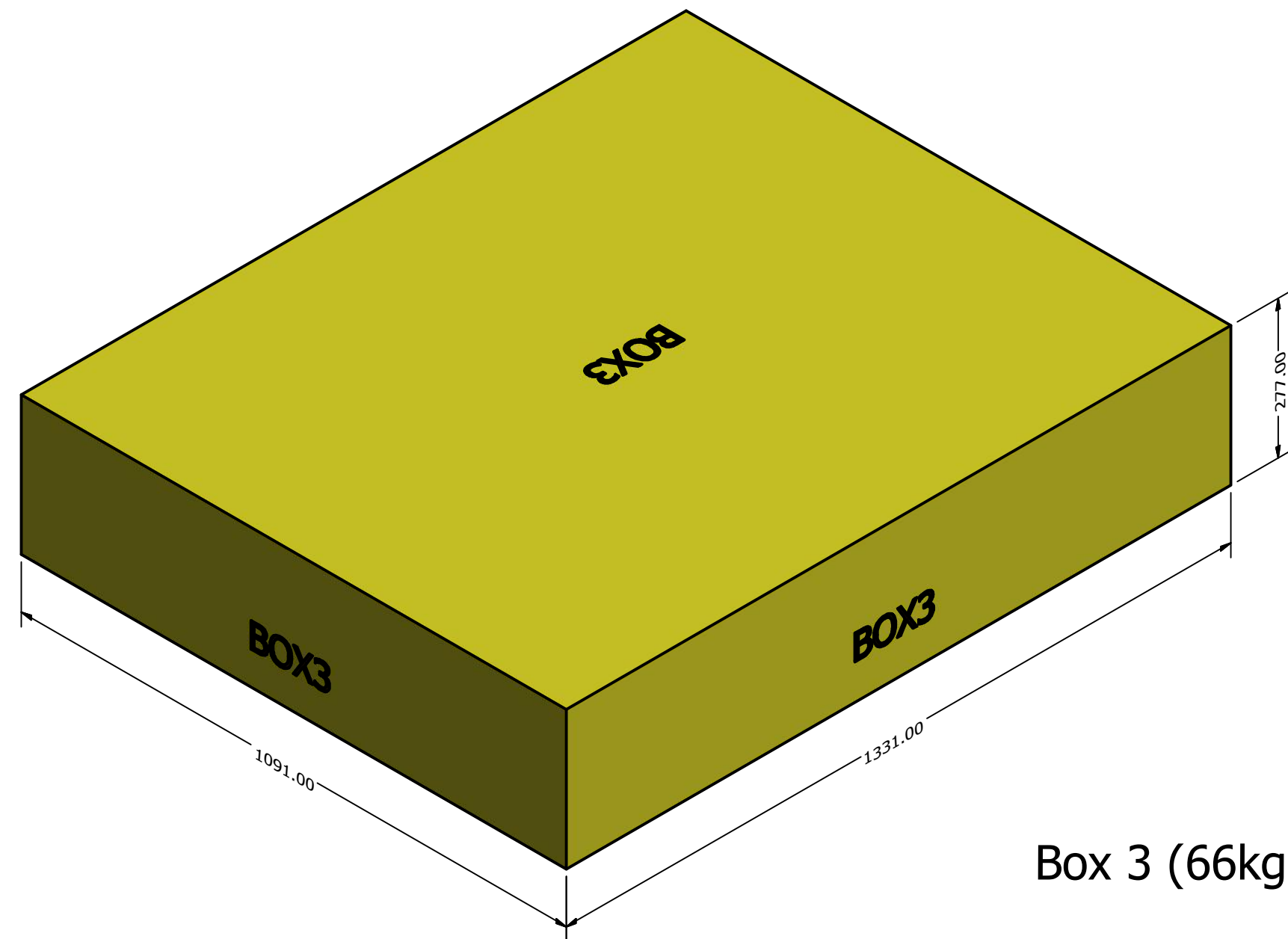

Box 3 (66kg)

DRAWN	Rudy	2021-5-11			
CHECKED			TITLE		
QA					
MFG					
APPROVED					
			SIZE	DWG NO	REV
			D		
			SCALE	1 : 8	SHEET 1 OF 1