

# HUBBELL WIRE TRAY

# INSTALLATION GUIDE

Innovative, Flexible, Field-Configurable Wire Basket Tray Solutions

## Contents

<b>General Installation and Assembly Instructions</b> .....	<b>2</b>
How to Cut .....	3
<b>Assembly Instruction</b> .....	<b>4</b>
90° with Corner Splice.....	4
90° Sweep Elbow (Large Radius) .....	6
Tee Fittings .....	7
Wye Junctions.....	8
Elevation Changes.....	9
Reducers.....	10
Divider Installation.....	12
Strut Clip.....	13
Under Floor Tray .....	14
Ground Bolts.....	15
Change of Direction Supports .....	16
No-Splice Support .....	17
Pre-Formed Fittings (30°, 45°, 90°, Tee & Intersection).....	19



## General Installation and Assembly Instructions

**NOTICE:** For installation by a qualified installer in accordance with all national and local electrical codes, communications standards, building codes, the following instructions and any instructions included with individual devices.

**CAUTION:** Always wear eye protection when cutting basket tray wire sections.

**WARNING:** Cut edges may be sharp, use care when handling trimmed basket tray during fabrication and installation.

Cable tray must be installed in accordance with the NEC® and CE Code, and must be properly bonded per NEC section 250.96 and CE Code Rule 12-2208, as applicable. To meet this requirement, Hubbell® UL classified splices or No-splice supports must be used to join sections of basket tray together. To properly bond Hubbell® painted cable tray, remove the plastic masking device from the trays on each end (exposing the pre-galvanized wire), and splice sections together using Hubbell® splice kits. For cable trays that are not UL Classified as being "Suitable as an Equipment Grounding Conductor", a separate grounding means using approved ground conductors and grounding connectors is required.

Proper installation and product selection must take into consideration conditions and materials at the installation site, environmental conditions, and manufacturer established parameters for the use of this product. Installation must not exceed established load ratings, cable fills or ampacities as specified by NEC® and CE Code. Device type and ratings must be suitable for the application.

Failure to comply with the manufacturer's instructions or usage parameters, including improper cutting or modifying any of the products, may result in reduced product life or product failure, potentially resulting in damage to person and property, and may void classifications, certifications, and listings for which the product was designed and tested.

For seismic applications Hubbell recommends contacting a local Seismic Engineering firm to design a system to conform with all local building codes.



# General Installation and Assembly Instructions

## How to Cut

To trim wire basket tray sections, it is recommended to use HBTCUTTOOL (purchased separately) or equivalent cutting tool.

Catalog Number	Description	Qty. per Box	Weight (Lb/each)
HBTCUTTOOL	Manual offset angled cutting tool, 24" leveraged handle	1	6.0

- Always make field cuts with the side action angle cutting tool.
- Mark sections to be cut.
- Cuts can be made on any finish, width or depth basket tray.
- Cut as many segments required for sweep elbows.
- Remove any sharp edges to eliminate possible damage to cables.



### **Bottom Cutting Order**

- Cut the bottom wires first, in order as shown, from the unders
- Rest the lower jaw of the cutters against the cradle wire and away from the new end.



### **Side Cutting Order**

- Cut the side wires next, starting with the top wire.
- Make sure the finished cut is safe and ready for installation.

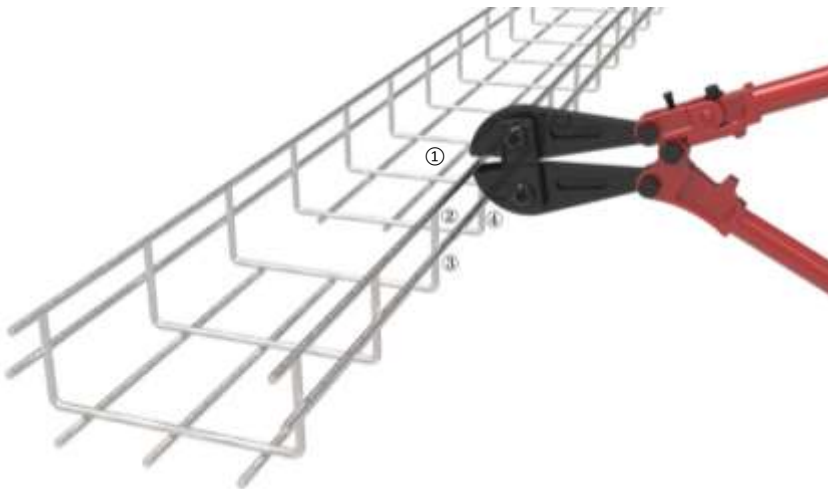

# Assembly Instruction

## 90° with Corner Splice

### HORIZONTAL BEND CUT & CONNECTOR PATTERN

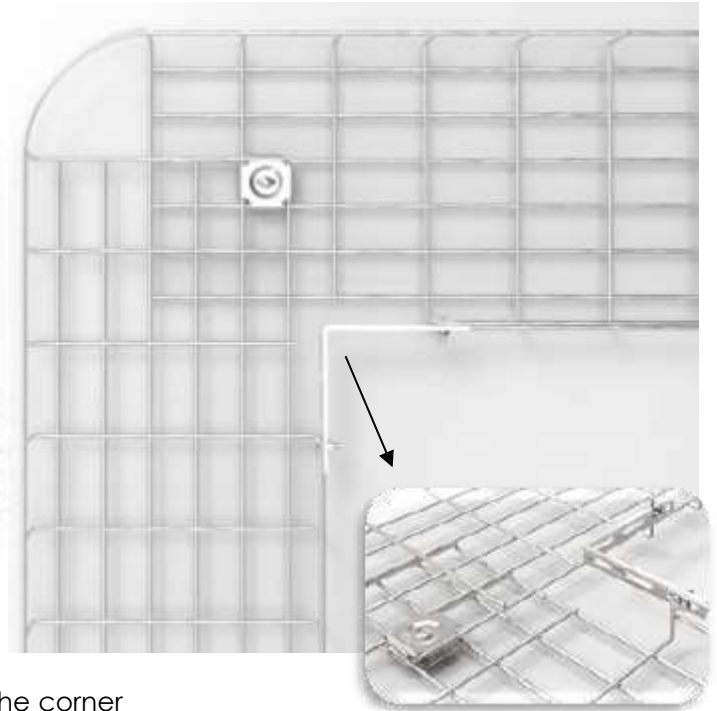
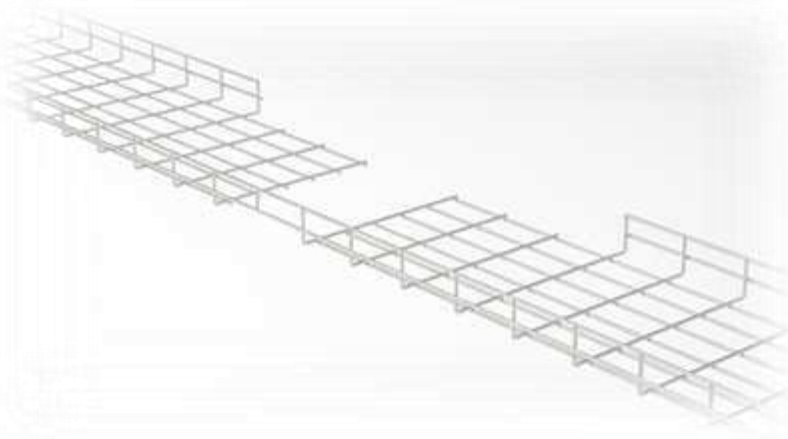

Refer to the images below to determine how many tray sections will be required to be cut from the tray for the corner splice. Ensure that the side wire cuts and the mid-section cuts are always symmetric.

Secure 90° corner splice kit (HBTCsxx) to the inside corner with provided mounting hardware. Secure overlapping tray with (2) HBTWS washer supports and HBTNB 1/4" X 20 Nut and Bolt. Always install bolt heads on the inside of the tray to protect cables.

Installing a ground conductor along fitting is required to ensure bonding across removed sections.

#### 4" TRAY WIDTH



#### 6" TRAY WIDTH

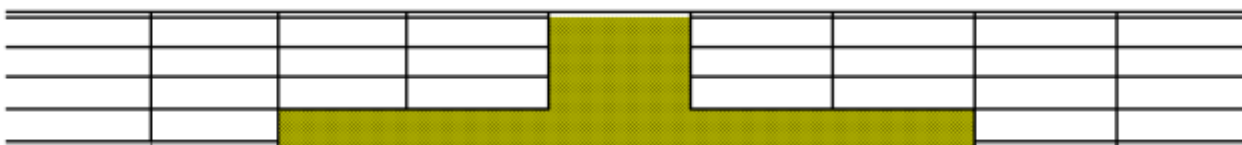



8" TRAY WIDTH



12" TRAY WIDTH

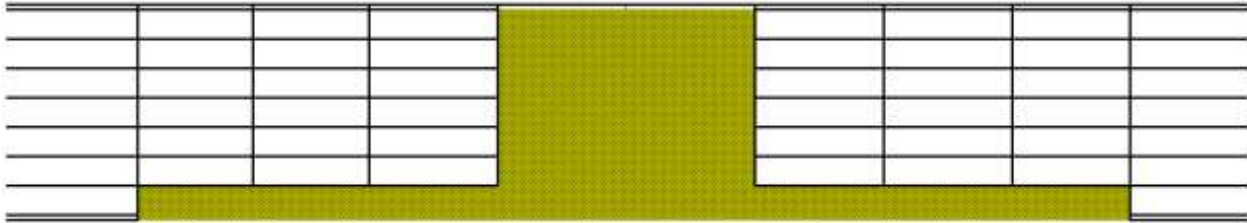

18" TRAY WIDTH

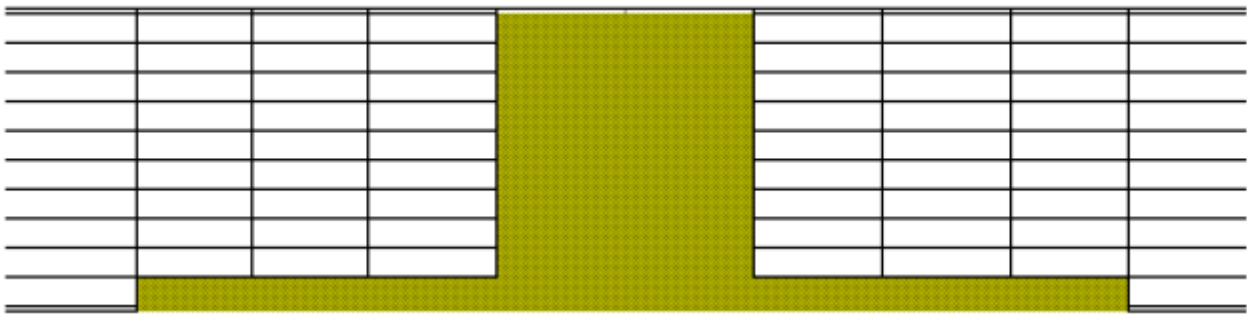

20" TRAY WIDTH

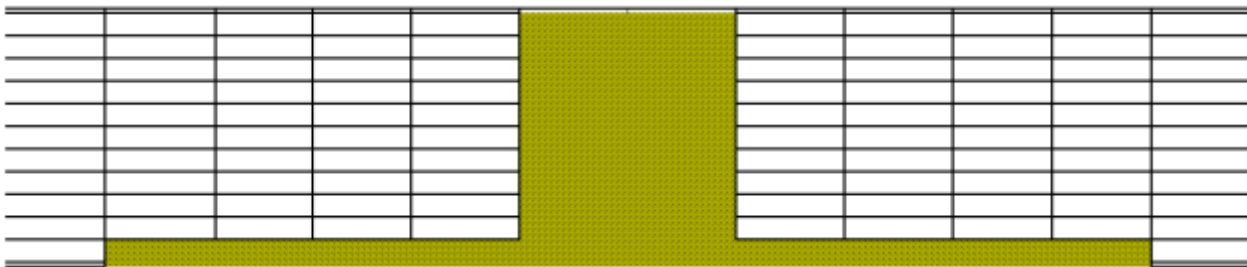

24" TRAY WIDTH

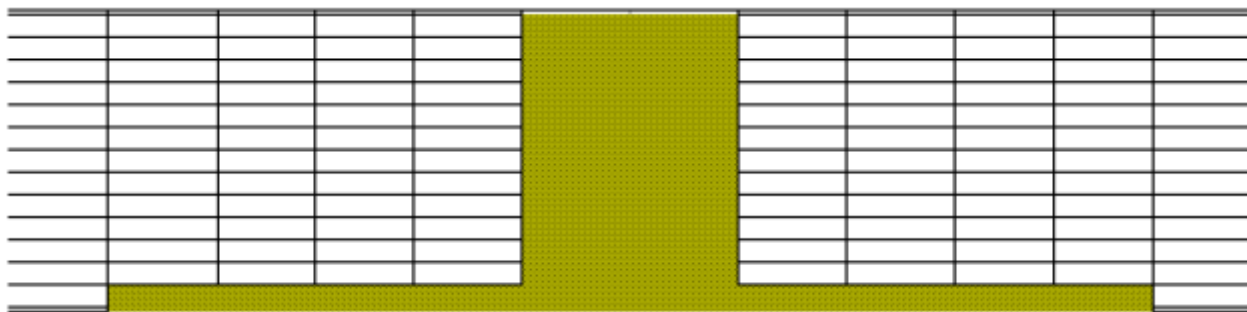

### HORIZONTAL BEND CUT & CONNECTOR PATTERN

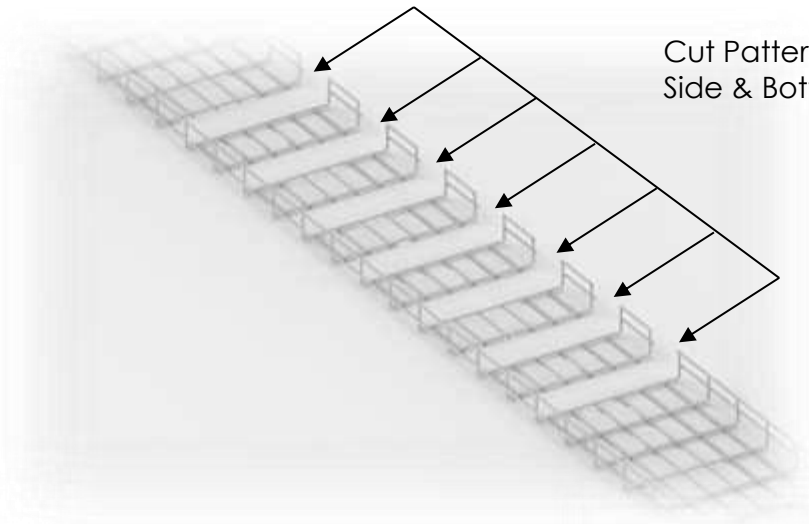

Cut Pattern:  
Side & Bottom section removed

- Refer to the table below to determine how many tray sections will be required to be cut from the tray for the turn (See images for detail).
- The number of hardware pieces (Splice kit) required will vary according to the number of Section to be removed.
- Use Standard Splice Kits (HBTSKxx), Bar Splice (HBTBSxx) optional for the connections.
- Always install bolt heads on the inside of the tray to protect cables.
- Installing a ground conductor along fitting is required to ensure bonding across removed sections.

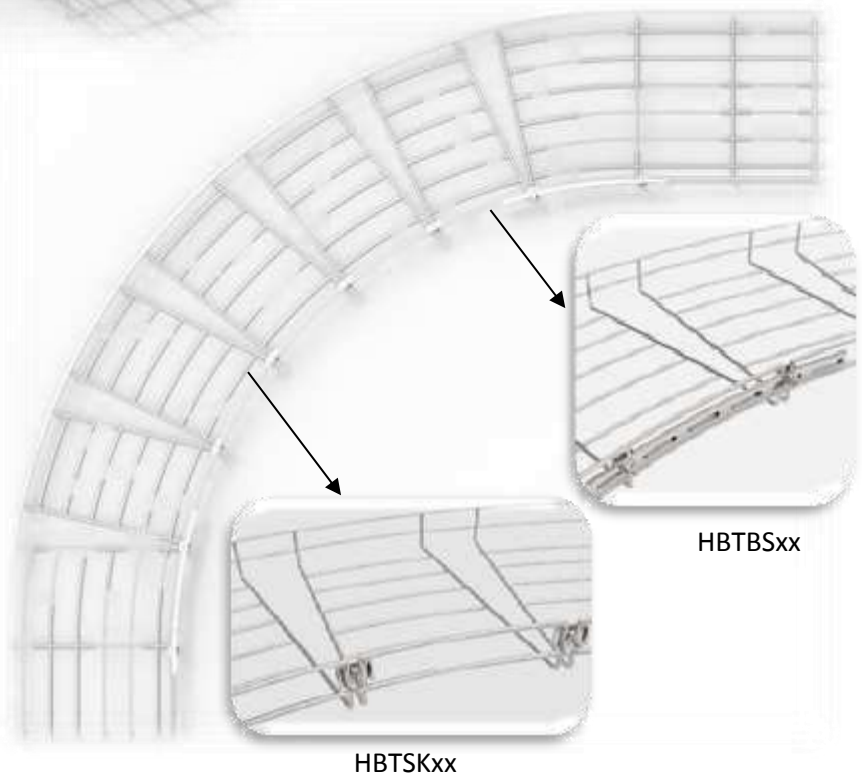

Tray Width (INCHES)	2	4	6	8	12	18	20	24
No of Side & Bottom section to be removed	2	3	4	4	6	8	9	11

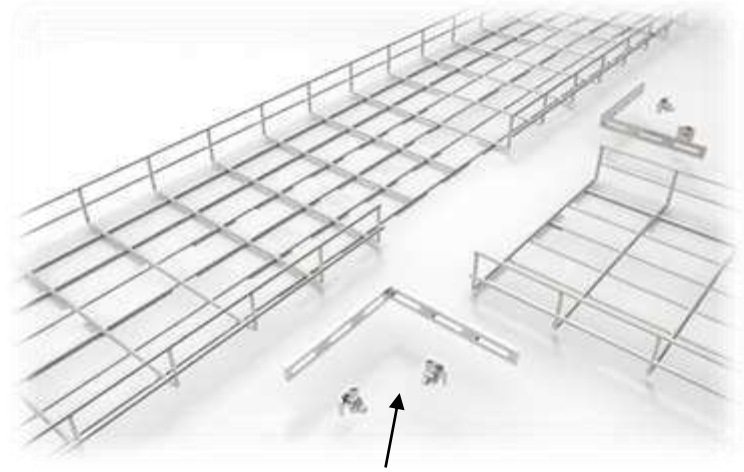
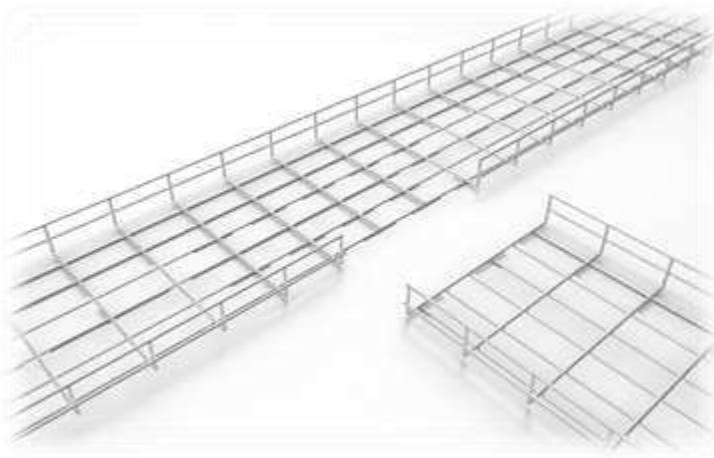

HBTCSxx

- Cut out side rail of main run according to width of the intersecting tee.
- Attach short tee radius with 90 degree corner splice using provided mounting hardware.
- Always install bolt heads on the inside of the tray to protect cables.
- Installing a ground conductor along fitting is required to ensure bonding across removed sections.

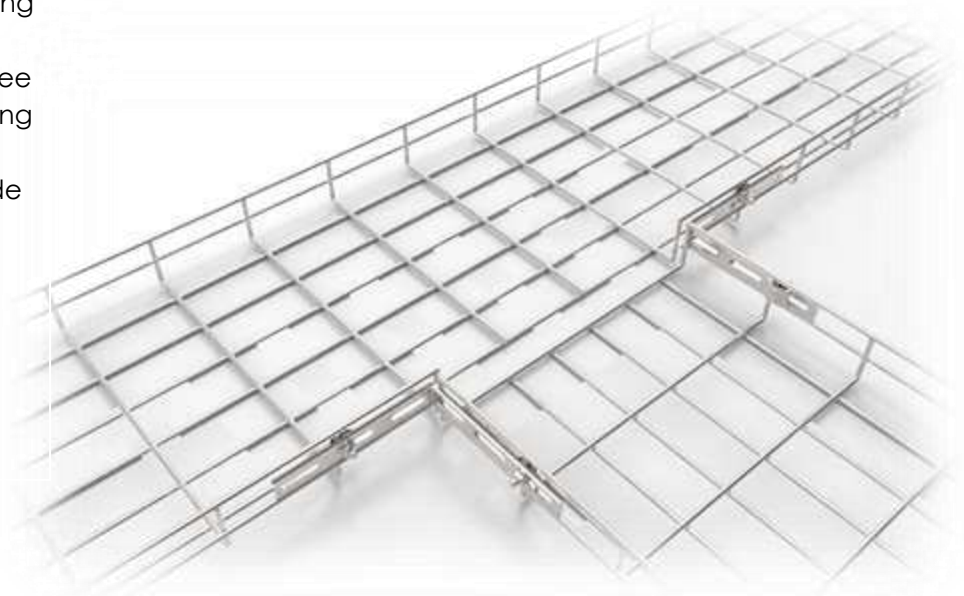

Tray Width (INCHES)	2	4	6	8	12	18	20	24
No of Side section to be removed	1	1	2	2	3	5	5	6

# Assembly Instruction

## Wye Junctions

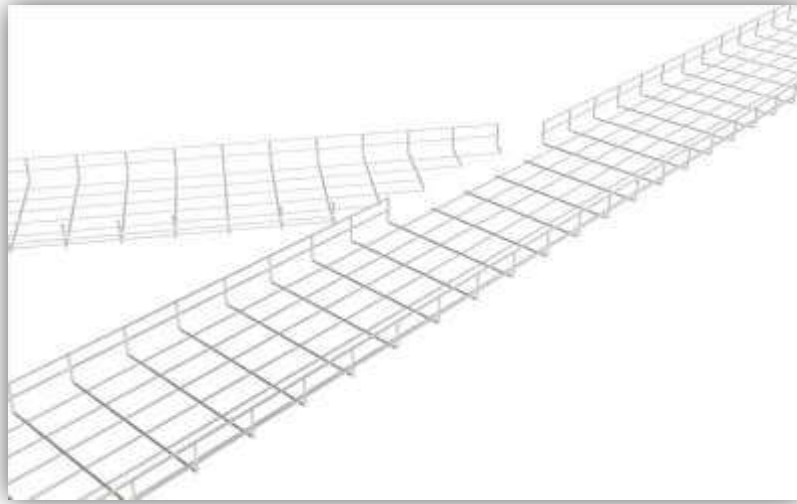

- Remove bottom wires at angles on attachment tray.
- Remove side wires from the main tray.
- Attach pieces with splice kits.
- Always install bolt heads on the inside of the tray to protect cables.
- Installing a ground conductor along fitting is required to ensure bonding across removed sections.



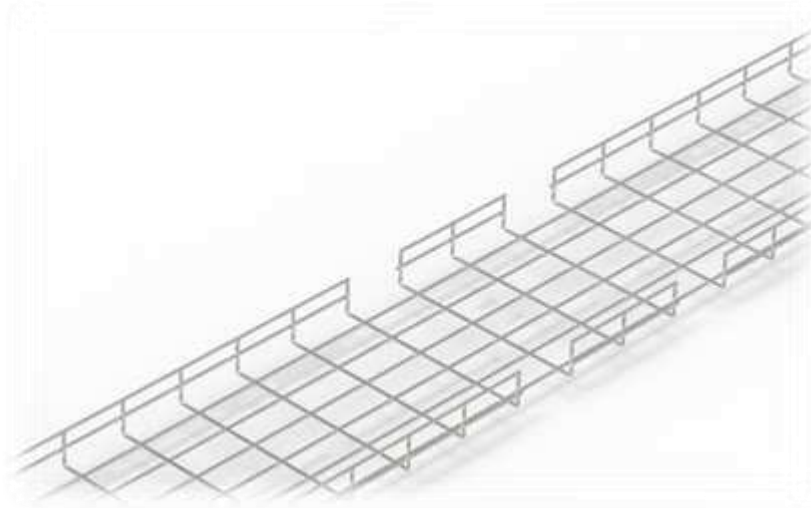

- Cut side wires to make vertical bend
- To avoid obstacles, alternate cuts can be made to make a variety of vertical drops and rises.
- Refer images for cutting and bending procedures.
- Install supports at either side of elevation change.
- Always install bolt heads on the inside of the tray to protect cables.



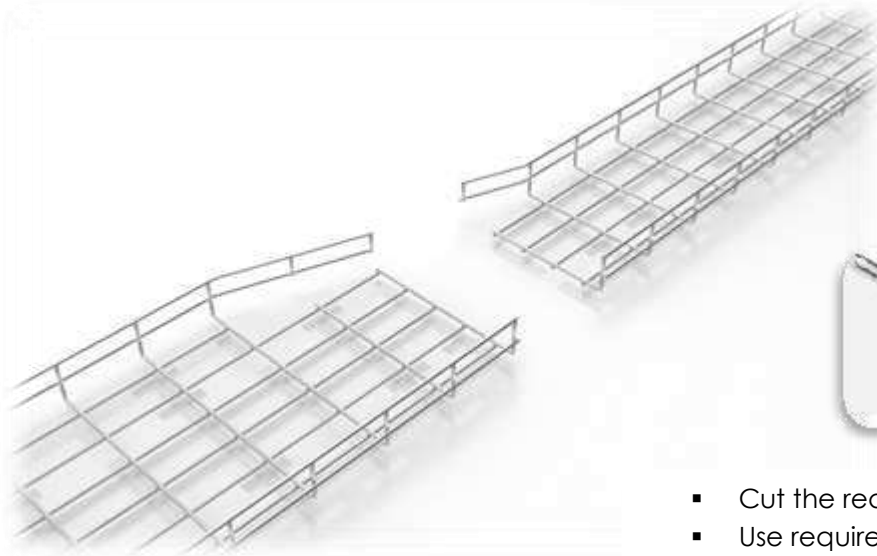

Splice Kit  
(HBTSKxx)



Bar Splice  
(HBTBSxx)

- Cut the required bottom wires and bend the side walls.
- Use required number of splice kits (HBTSKxx) and Bar splice (HBTBSxx) to make the connection.
- Always install bolt heads on the inside of the tray to protect cables.
- Refer to images for cutting and bending requirements.
- Installing a ground conductor along fitting is required to ensure bonding across removed sections.

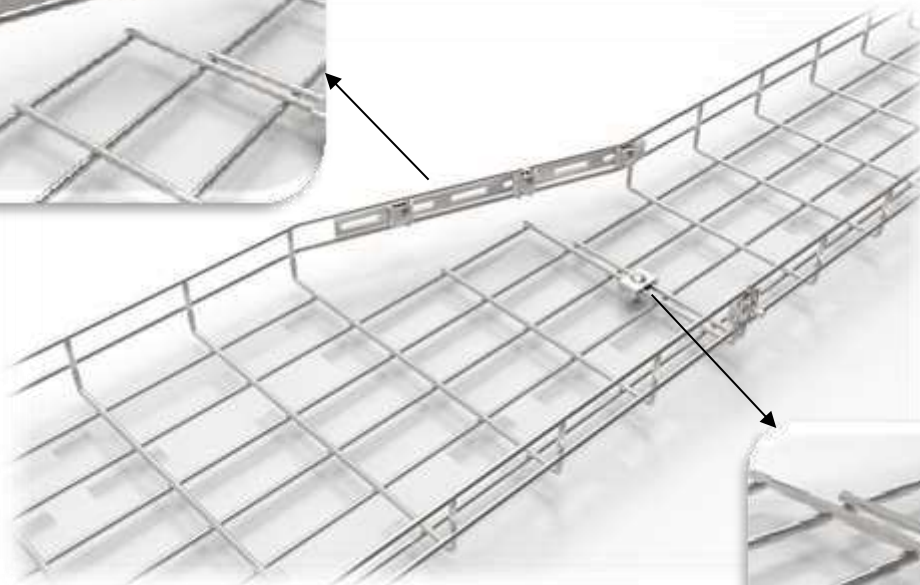
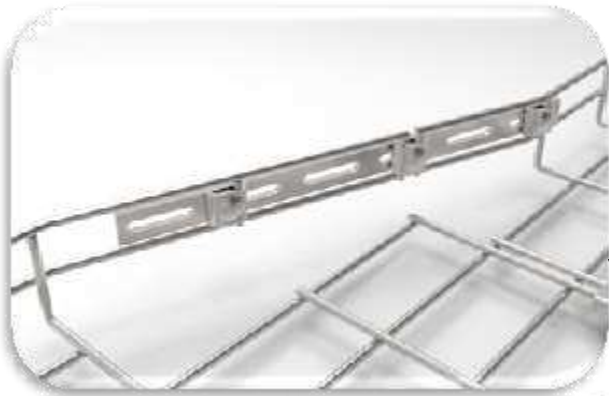

Offset Reducer

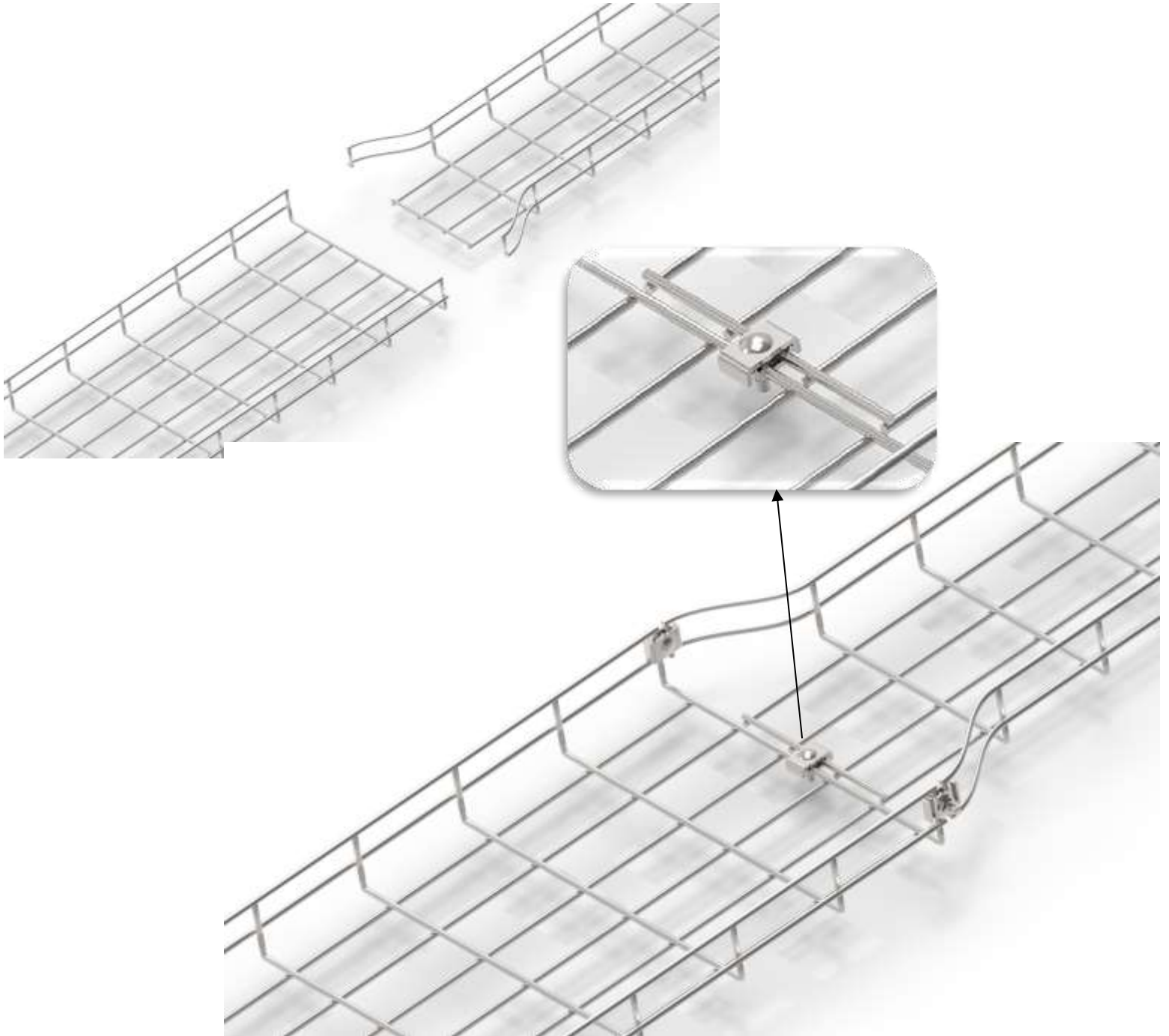

### Straight Reducer

- Cut the required bottom wires and bend the side walls.
- Use required number of splice kits (HBTSKxx) to make the connection.
- Always install bolt heads on the inside of the tray to protect cables.
- Refer images for cutting and bending requirements.
- Installing a ground conductor along fitting is required to ensure bonding across removed sections.

# Assembly Instruction

## Divider Installation



OPTION 1

USING SPLICE KIT(HBTSK)



- Place the divider on the tray as required.
- Install Splice Kit (HBTSKxx) in order to securely attach the tray and divider together.
- Always install bolt heads on the inside of the tray to protect cables.



OPTION 2

USING WASHER (HBTWS)  
AND BOLT & NUT(HBTNB)



- Place the divider on the tray as required.
- Insert bolt into the slot of the divider from the top.
- Position washer through bolt and fit to tray.
- Tighten with the nut.
- Always install bolt heads on the inside of the tray to protect cables.



# Assembly Instruction

## Strut Clip



HBTSTRUTCLIP



- Place the wire tray on top of the Strut.
- Place the clip on the tray at the desired position.
- Squeeze the clip and slide it to the place to finish the connection.
- 12" trays or smaller use 2 clips per strut support.
- 16" - 18" trays use 3 clips per strut support.
- Larger trays add one clip per strut support for every 6" of tray width.



# Assembly Instruction

## Under Floor Tray

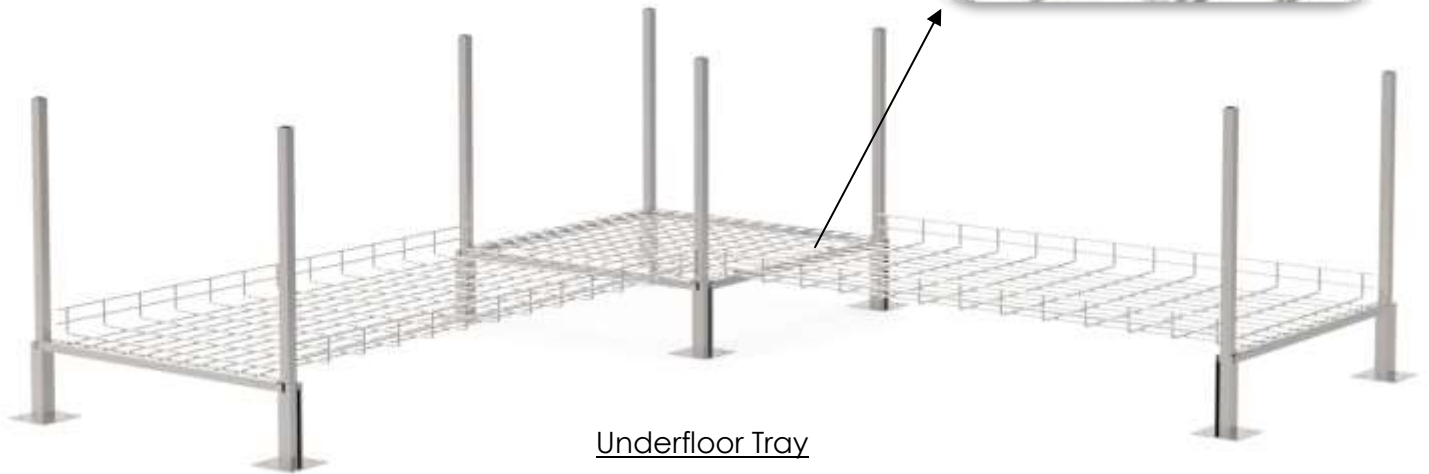

Underfloor Tray



Pedestal Kit (HBTUPK) with  
"L" Bracket (HBTLBxxx)



Pedestal Kit  
(HBTUPK)

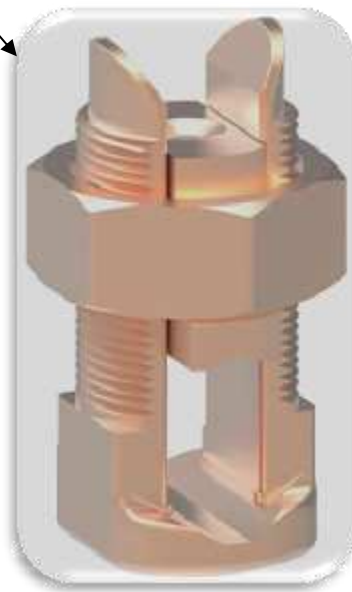
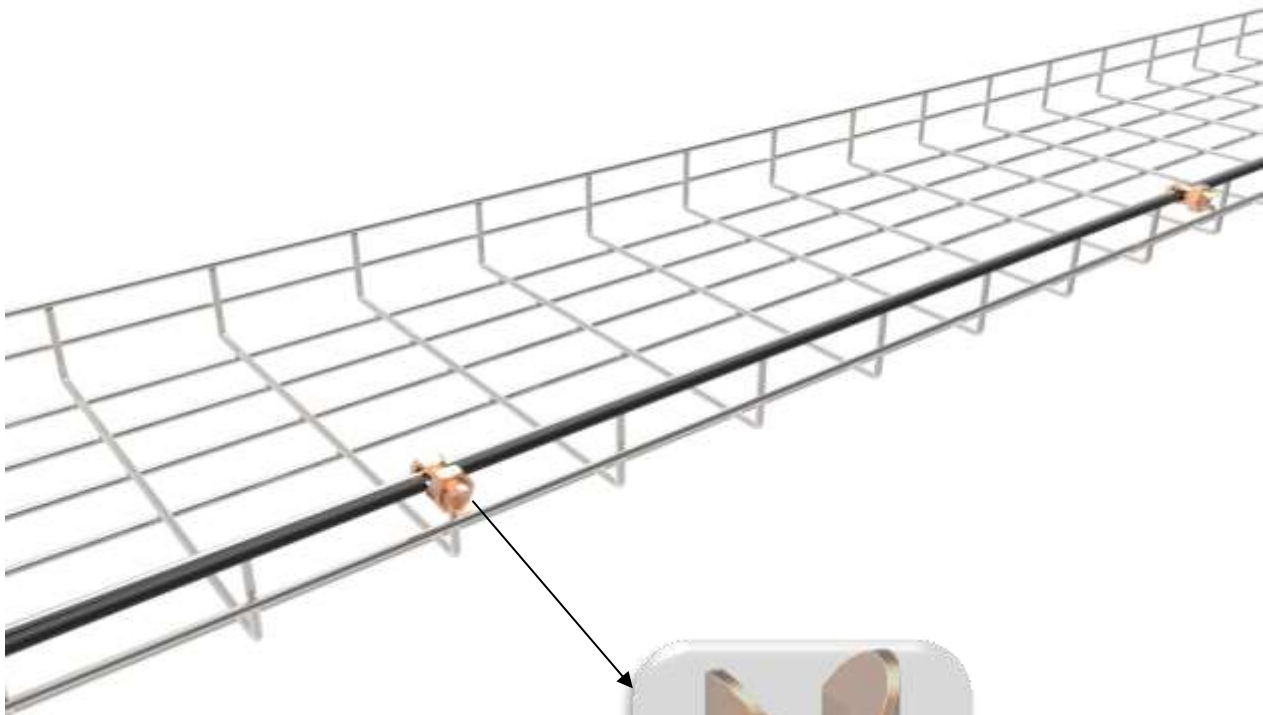

HBTSPPLITBOLTPK10

- Install a continuous ground conductor along the full length of the tray pathway.
- Run a ground wire from a secure grounding point to the cable tray.
- For painted trays ensure that there is metal-to-metal contact by removing the paint where the Split Bolt Grounding Clamp contacts the cable tray.
- Always install a grounding conductor across field cut fittings.

### Horizontal Tee Support

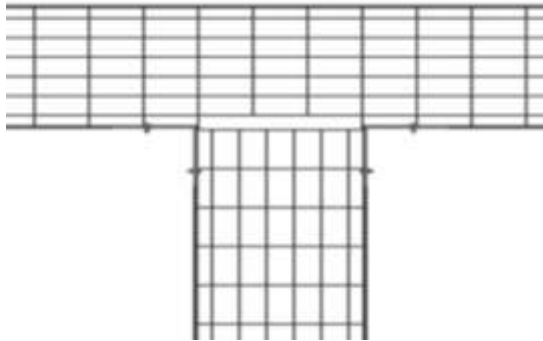

Additional support recommended at back of Tee or directly under Tee, diagonally positioned for 4" and 6" deep trays, or tray 18" and wider

### Horizontal Intersection Support

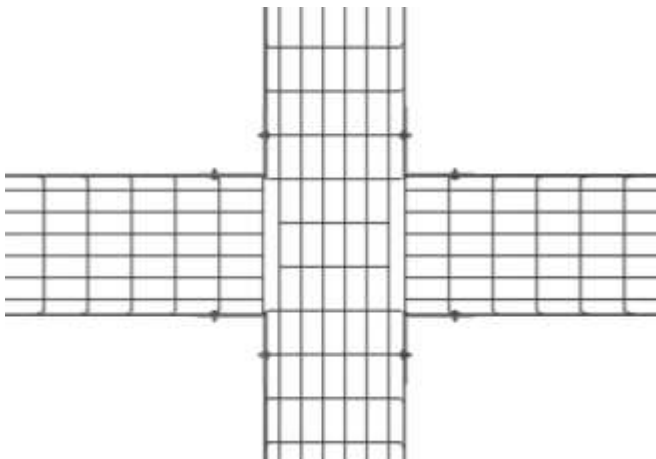

On 24" wide items, recommended distance is 1 ft. 6 in. from splice connection

# Assembly Instruction

## No-Splice Support



- Use provided washer and 1/4" -20 self tapping screws to clamp the tray and center support to form a straight connection.
- No-Splice supports accept up to 1/2" threaded rod.

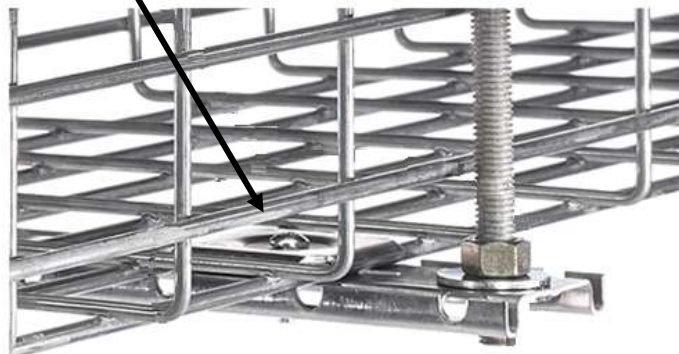

No-Splice Supports should be spaced every 5 feet. The tray will sit on top of the support located in the middle of the tray.



**1. Utilizes factory ends of bottom rails to lock into the No Splice Support Notches**

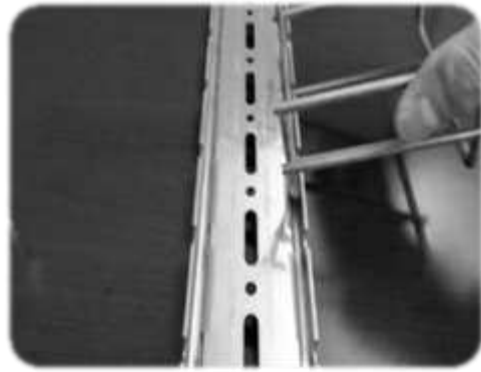

**2. Lift the 1<sup>st</sup> tray and insert into support**



**3. Lock the 1<sup>st</sup> tray into support by pushing downward**



**4. Lift and insert 2<sup>nd</sup> tray into support**

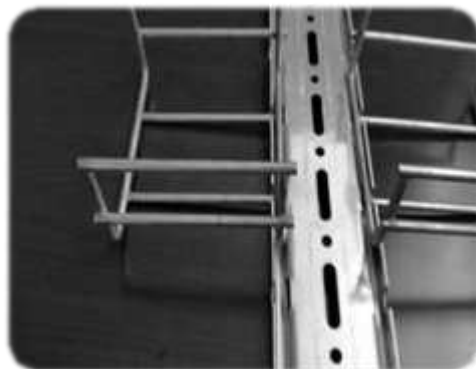

**5. Lock 2<sup>nd</sup> tray into support by pushing downward**



**6. Secure with supplied washer support & self tapping 1/4" -20 screw (HBTUGS mounting hardware included)**



# Assembly Instruction

## Pre-Formed Fittings (30°, 45°, 90°, Tee & Intersection)

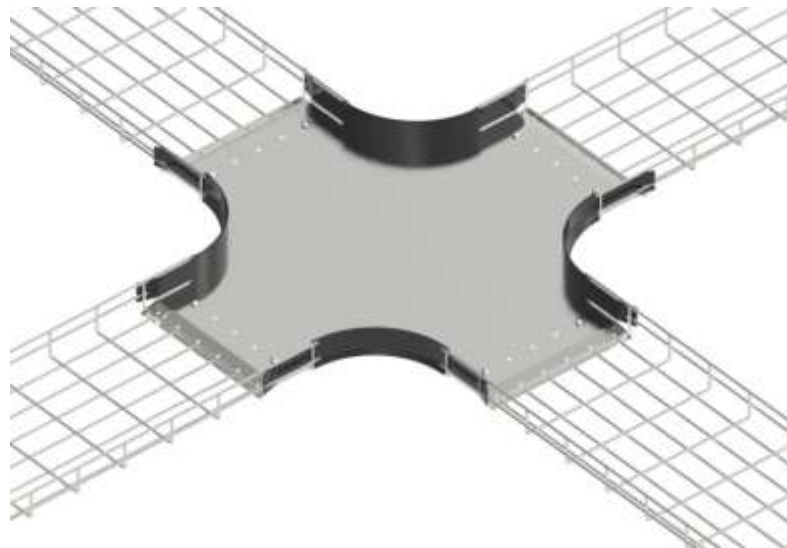
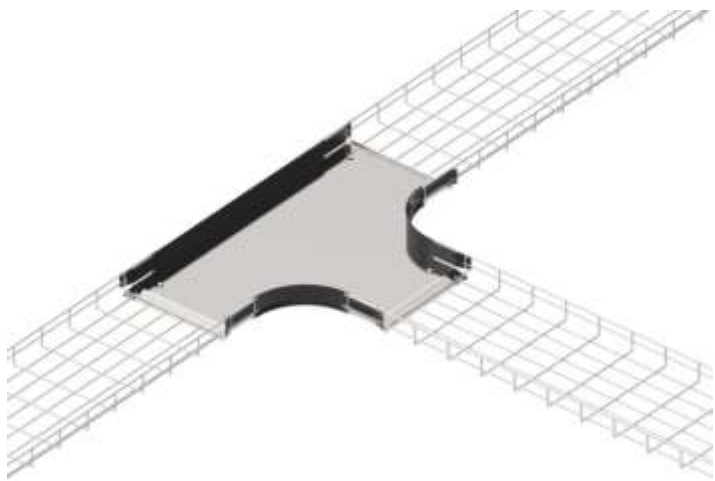
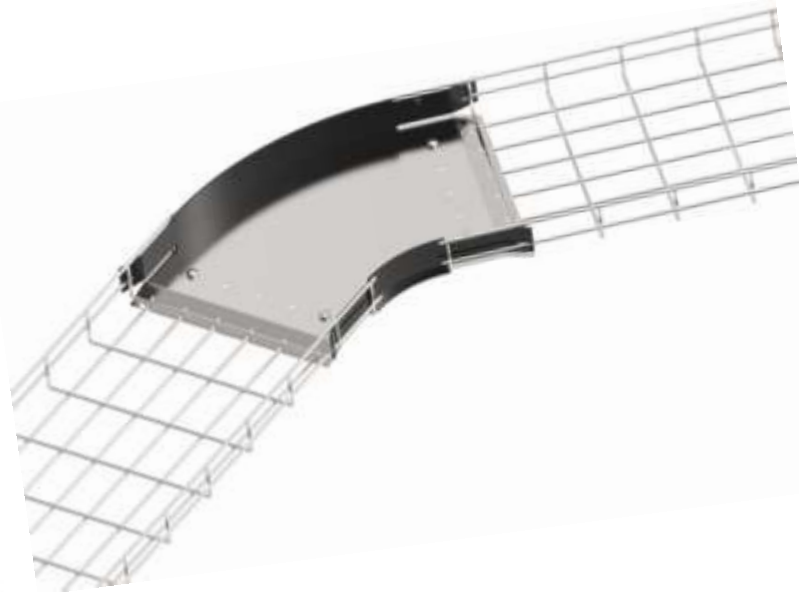
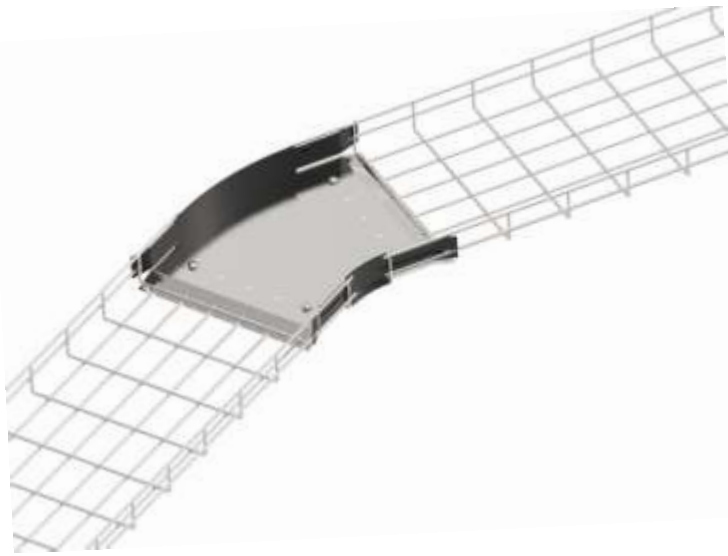

**Step 1:**

Splicing hardware included.

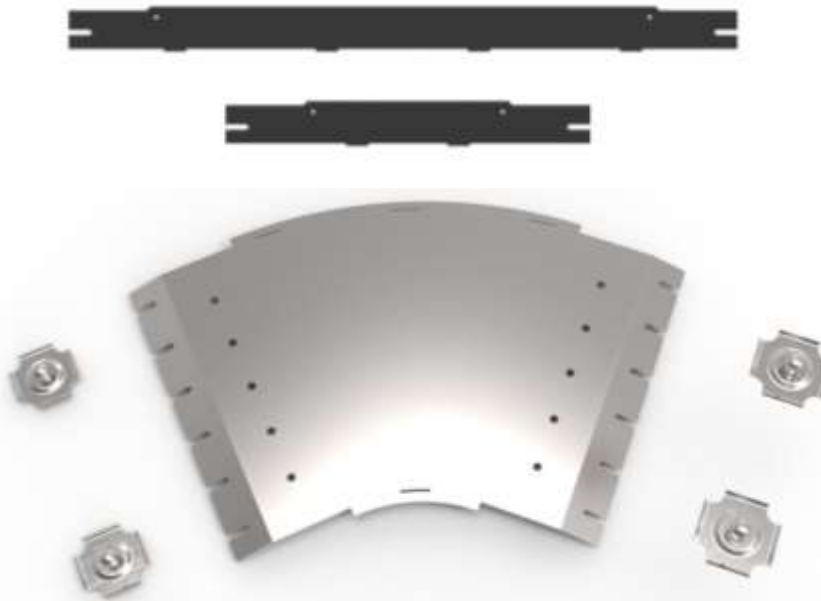

**Step 2:**

Attach first tray to the fitting base with the supplied mounting hardware.

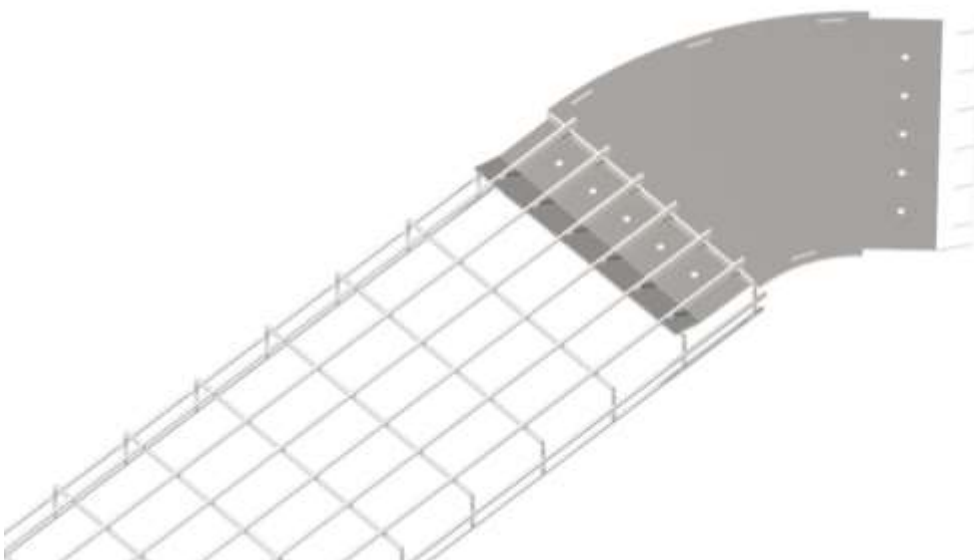

**Step 3:**

Tighten mounting hardware.

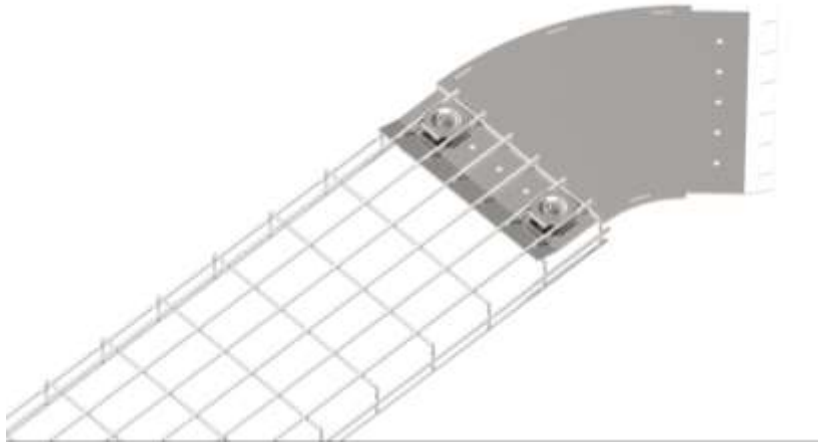

**Step 4:**

Attach second tray

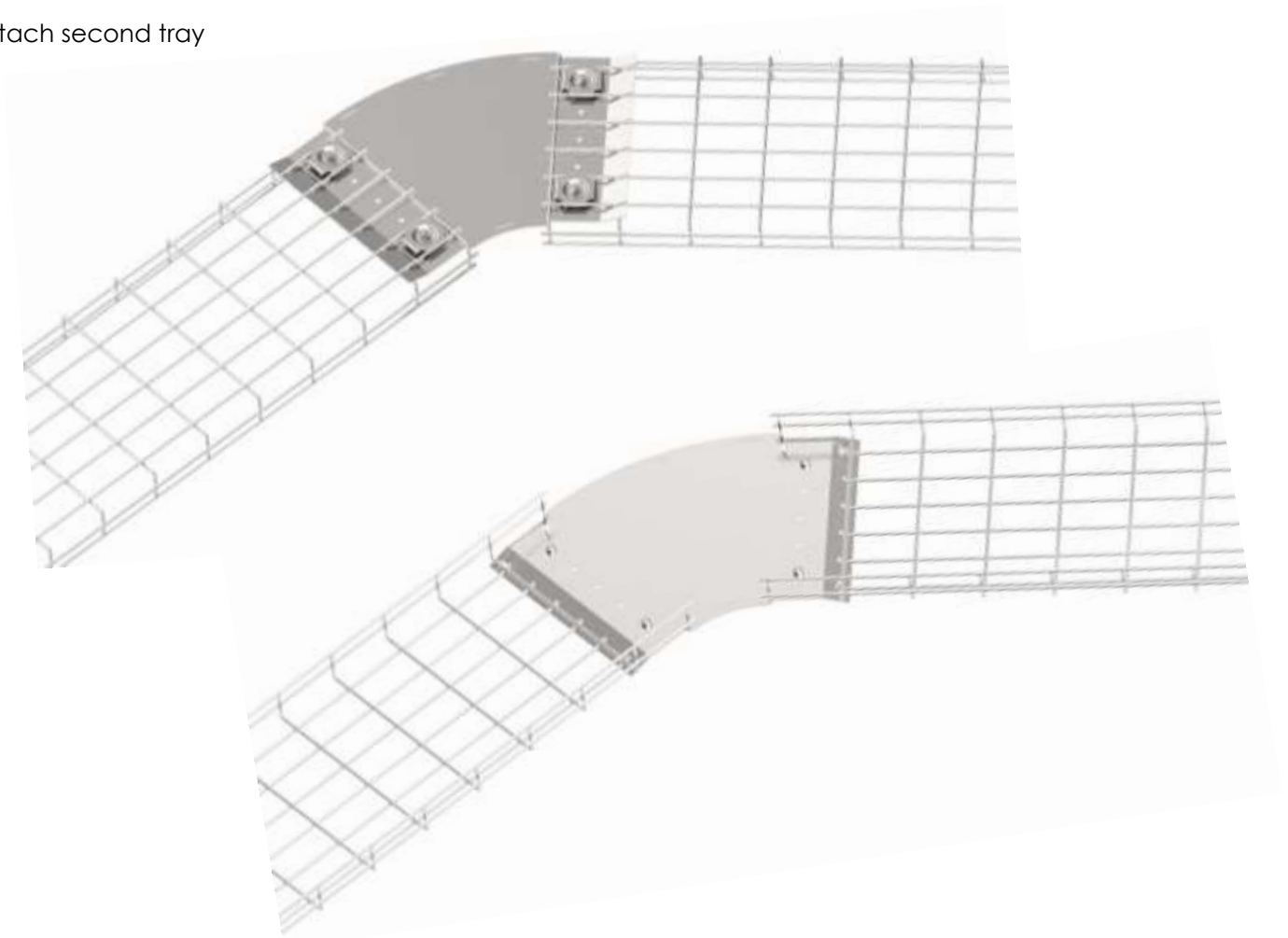

**Step 5:**

Install polymer side wall into slots in base and along side rail of tray as shown. Bend polymer tabs under fitting base to complete the Installation.

