



bestchoiceproducts



INSTRUCTION MANUAL

Massage Chair with Ottoman



bestchoiceproducts

Thank you for choosing us! Since 2002, Best Choice Products has been bringing customers high-quality products at the absolute lowest price. With everything ranging from instruments and toys to furniture and outdoor, we've got your everyday living essentials covered. We're centered around a customer-first philosophy - with free shipping, exceptional customer service, and a catalog sourced with you in mind.

TOOLS REQUIRED



1 PERSON
ASSEMBLY



APPROXIMATELY
20 MIN.
ASSEMBLY

HARDWARE

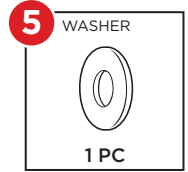
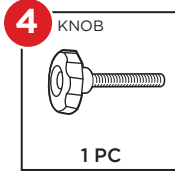
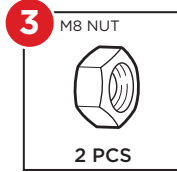
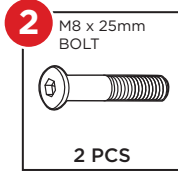
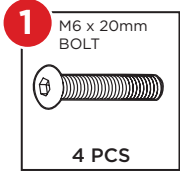

PARTS

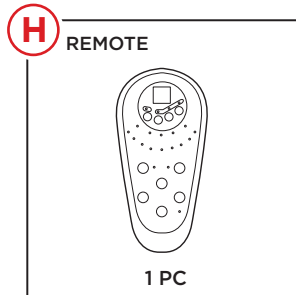
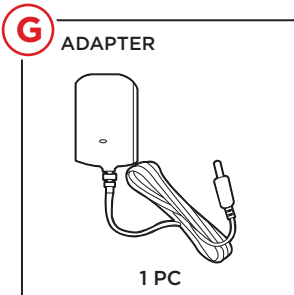
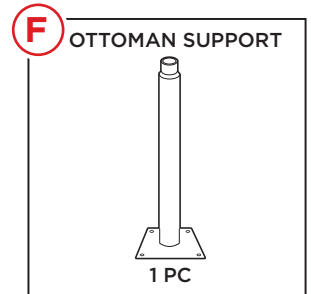
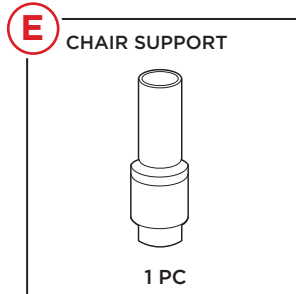
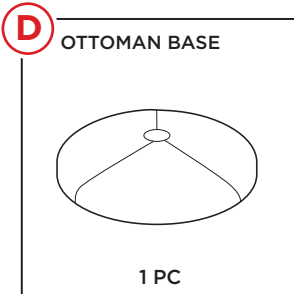
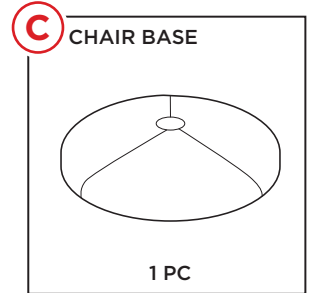
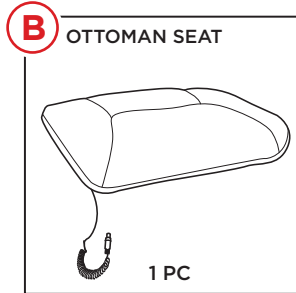
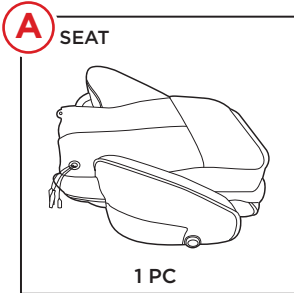

PRODUCT ASSEMBLY

Please retain these instructions for future reference.

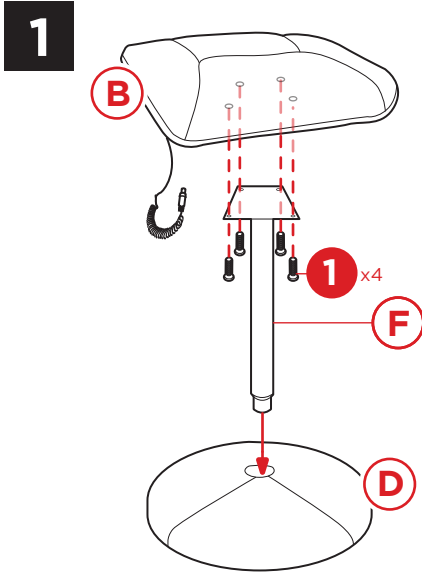

Attach part F ottoman support to bottom of part B ottoman seat with four part 1 screws. Insert the ottoman support and seat into the part D ottoman base.

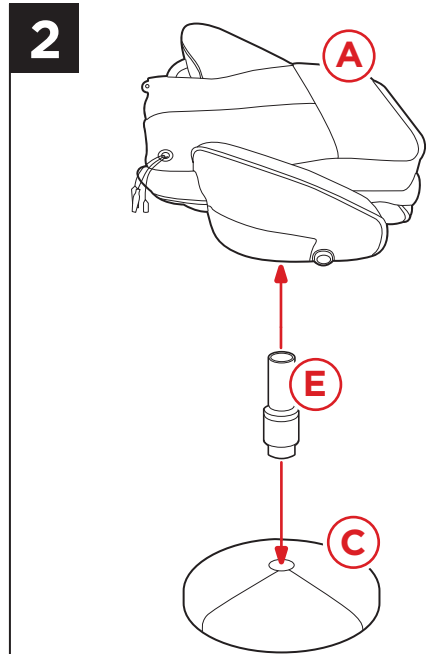

Assemble the chair.

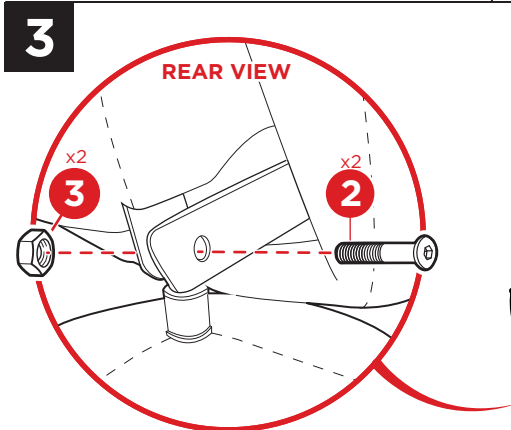

Unfold the chair. Insert two part 2 bolts into the hinges on the back of the chair and secure them with two part 3 nuts.

NOTE: Hinge holes should align. Make sure that the backrest is properly arranged on the seat.

Slide a part 5 washer onto the part 4 knob and screw the knob into the side of the chair.

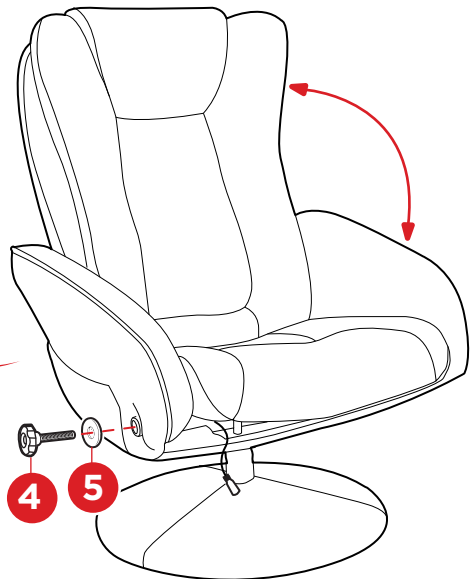

4



Join wire on the ottoman to the corresponding wire on the front of the chair.

Join the corresponding wires on the side of the chair. Join the part G adaptor and part H remote to the appropriate wires.

NOTE: Make sure that the sizes and colors match (white with white, etc.).

USE

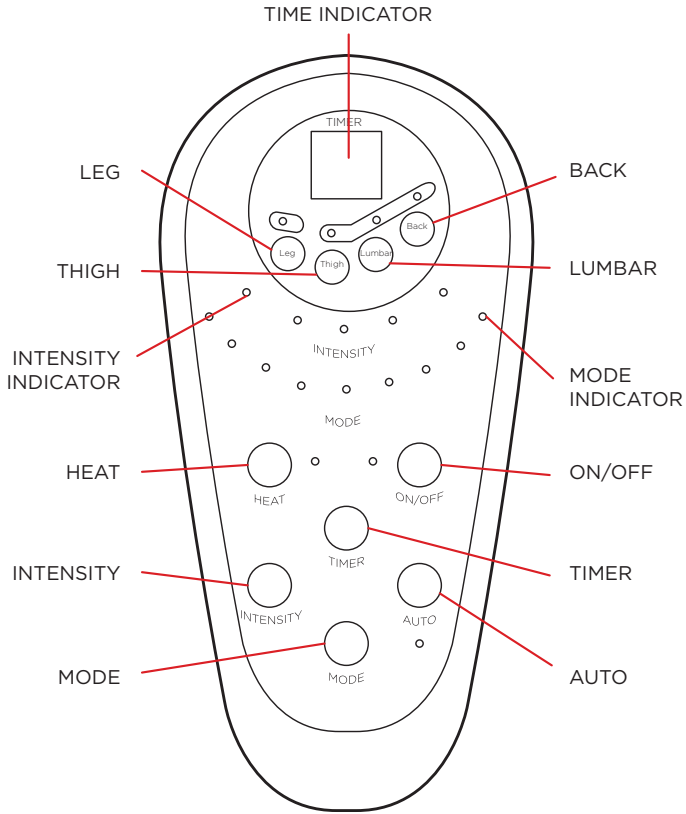

- **HEAT:** Turn on the heat function.
- **INTENSITY:** Turn on and cycle through 5 different intensities.
- **MODE:** Turn on and cycle through 9 different pre-programmed massage modes.
- **TIMER:** Toggle timer function.
- **BACK, LUMBAR, THIGHS, and LEGS:** Target massages to specific areas or turn off massage functions for specific areas.

SPECIFICATIONS

Chair Weight Capacity	250 lbs.
Ottoman Weight Capacity	200 lbs.

WARNING

- This massage chair features electrical components. Do not expose this massage chair to high temperatures or humidity.
- Always unplug this appliance when not in use.
- Only plug this product into a grounded outlet. Do not plug this product in with any electrical adaptor besides the included plug. Do not modify the plug in any way.
- Unattended children and individuals with impairments that may prevent them from safely operating this device should not use this chair.
- Do not stand on any part of the chair.
- Do not use this chair outdoors.
- Do not use this chair if massage mechanism is exposed.
- Do not use this chair if your physician or healthcare professional has advised against massage chair use.
- Do not use this chair if you are inebriated, have a pacemaker, heart condition, skin condition or injury, are pregnant, plan on becoming pregnant, have just given birth, have a disease like diabetes that disrupts sensory feedback, have osteoporosis, chronic pain or injuries, have a fever, or have other medical issues that may impede your ability to safely use this chair.
- Do not use this chair for sleeping, or if you have a history of narcolepsy.
- If you experience any pain, illness, or discomfort during use, discontinue using this chair and consult with a physician.
- Do not use massage chair at the same time as other medical or therapeutic devices, such as blanket warmer or another massage device.
- Only operate this device on a stable, flat surface.
- Do not operate massage function or heating function for long periods of time.
- Do not pull out the plug to turn off this massage chair. Turn off all functions before unplugging the chair.

NOTICE

- Firmly secure all parts before use.
- Reconfirm that all parts are secure every 90 days.
- Do not use or store this item or its parts in the proximity of open flame or flammable/combustible chemicals.
- Do not expose this chair or its electrical parts to water.
- If any parts are missing, broken, damaged, or worn, stop using this product until repairs are made and/or factory replacement parts are installed.
- Do not use this item in a way inconsistent with the manufacturer's instructions, as this could void the product warranty.
- Do not exceed 250 lbs. when using this chair. Do not exceed 200 lbs. on the ottoman. This chair and ottoman are not designed for multiple people to sit at once.
- Do not let small children or pets near during assembly.

ENJOY YOUR PRODUCT!

bcp



PRODUCT WARRANTY INFORMATION

All items can be returned for any reason within 60 days of the receipt and will receive a full refund as long as the item is returned in its original product packaging and all accessories from its original shipment are included. All returned items will receive a full refund back to the original payment method. All returned items will not be charged a re-stocking fee.

All returned items require an RA (Return Authorization) number, which can only be provided by a Best Choice Products Customer Service Representative when the return request is submitted. Items received without an RA may not be accepted or may increase your return processing time. Once an item has been received by Best Choice Products, refunds or replacements will be processed within 5 business days.

All returns must be shipped back to the Best Choice Products Return Center at the customer's expense. If the reason for return is a result of an error by Best Choice Products then Best Choice Products will provide a pre-paid shipping label via email. Boxes for return shipping will not be provided by Best Choice Products, and is the customer's responsibility to either use the original shipping boxes or purchase new boxes.

Pictures may be required for some returns to ensure an item is not damaged prior to its return. Items returned are not considered undamaged until they are received by Best Choice Products and verified as such. All damages to items are the customer's responsibility until the item has been received by and acknowledge by Best Choice Products as undamaged.

CONTACT US; WE'RE HERE 7 DAYS A WEEK TO HELP YOU!



bestchoiceproducts.com



customerservice@bestchoiceproducts.com



844.948.8400



[LEARN MORE!](#)

WARNING

Manufacturer and seller expressly disclaim any and all liability for personal injury, property damage or loss, whether direct, indirect, or incidental, resulting from the incorrect attachment, improper use, inadequate maintenance, or neglect of this product.