

# 2506060 14x14 LODGE GAZEBO Container Loading Diagram

( 1 set=7 boxes, 36 units/40HQ, 18 pallets/ 40HQ, Gross Weight:21140kg)

Top View

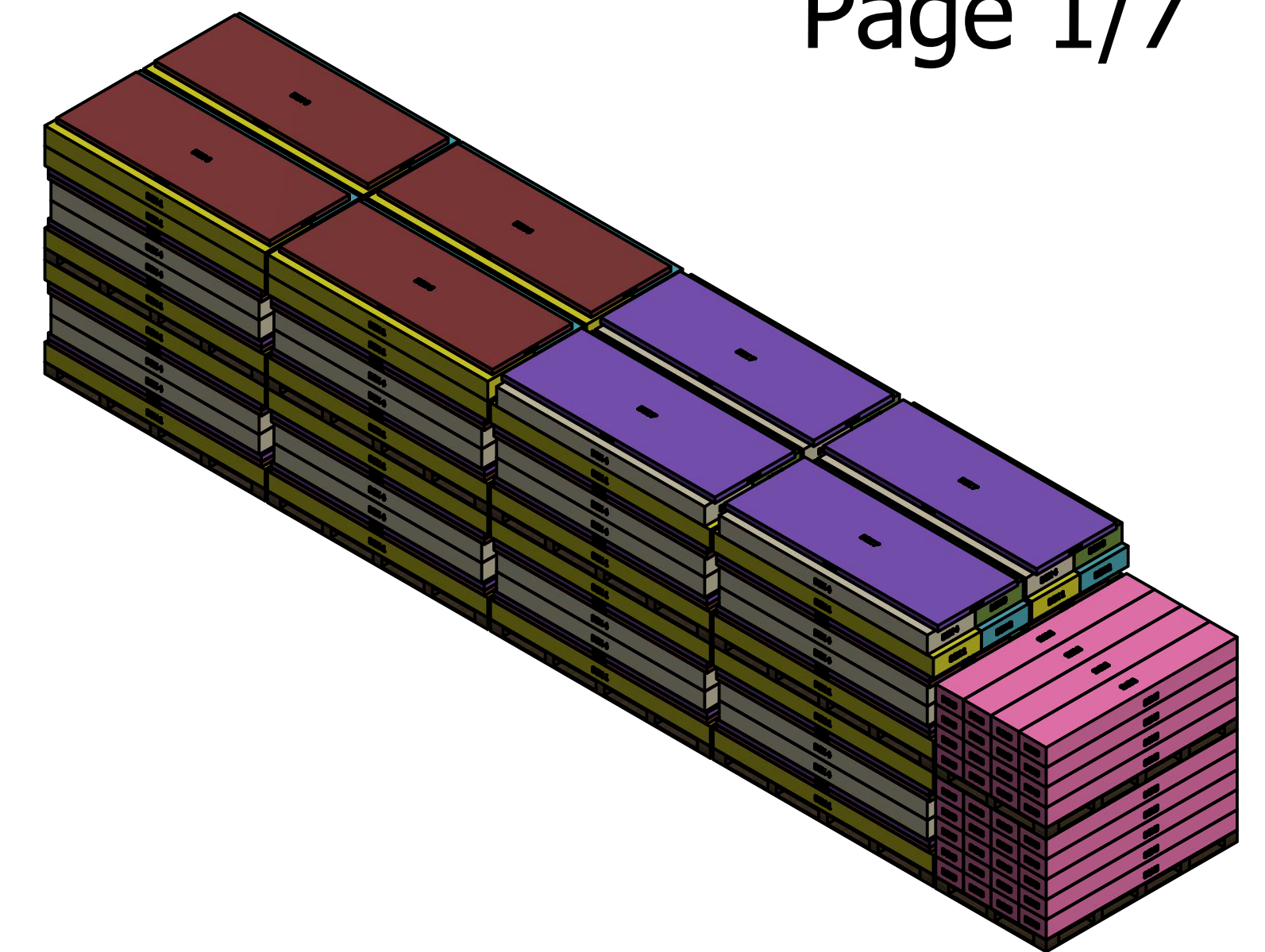
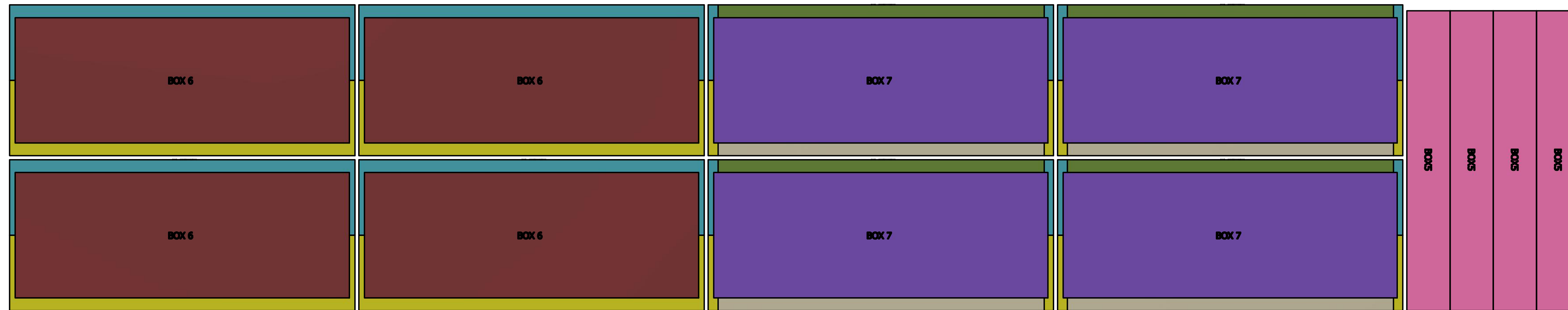

Side View

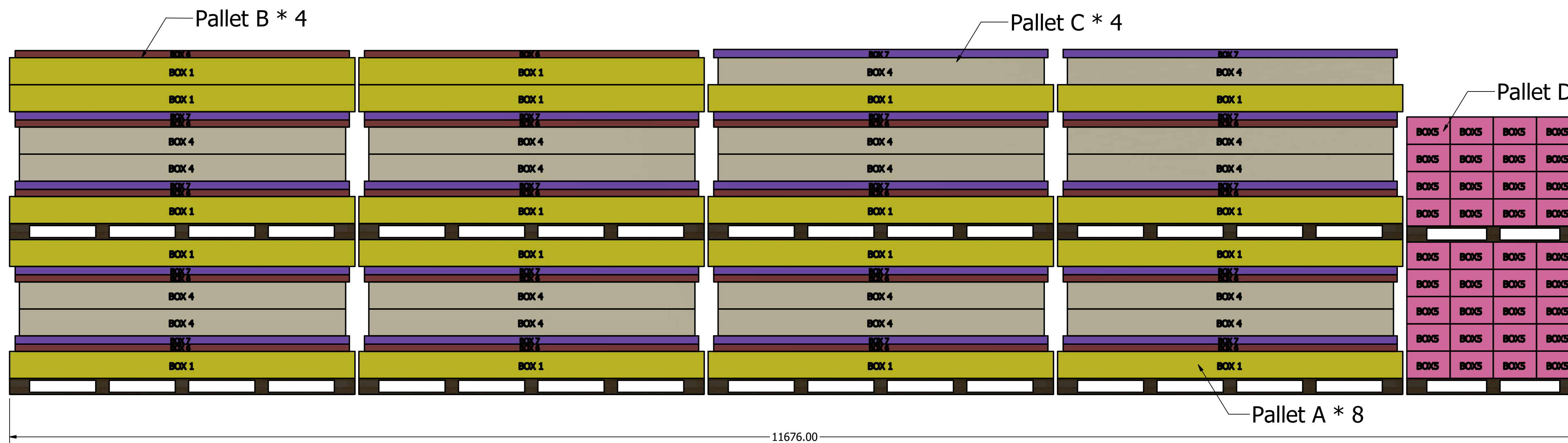

End View

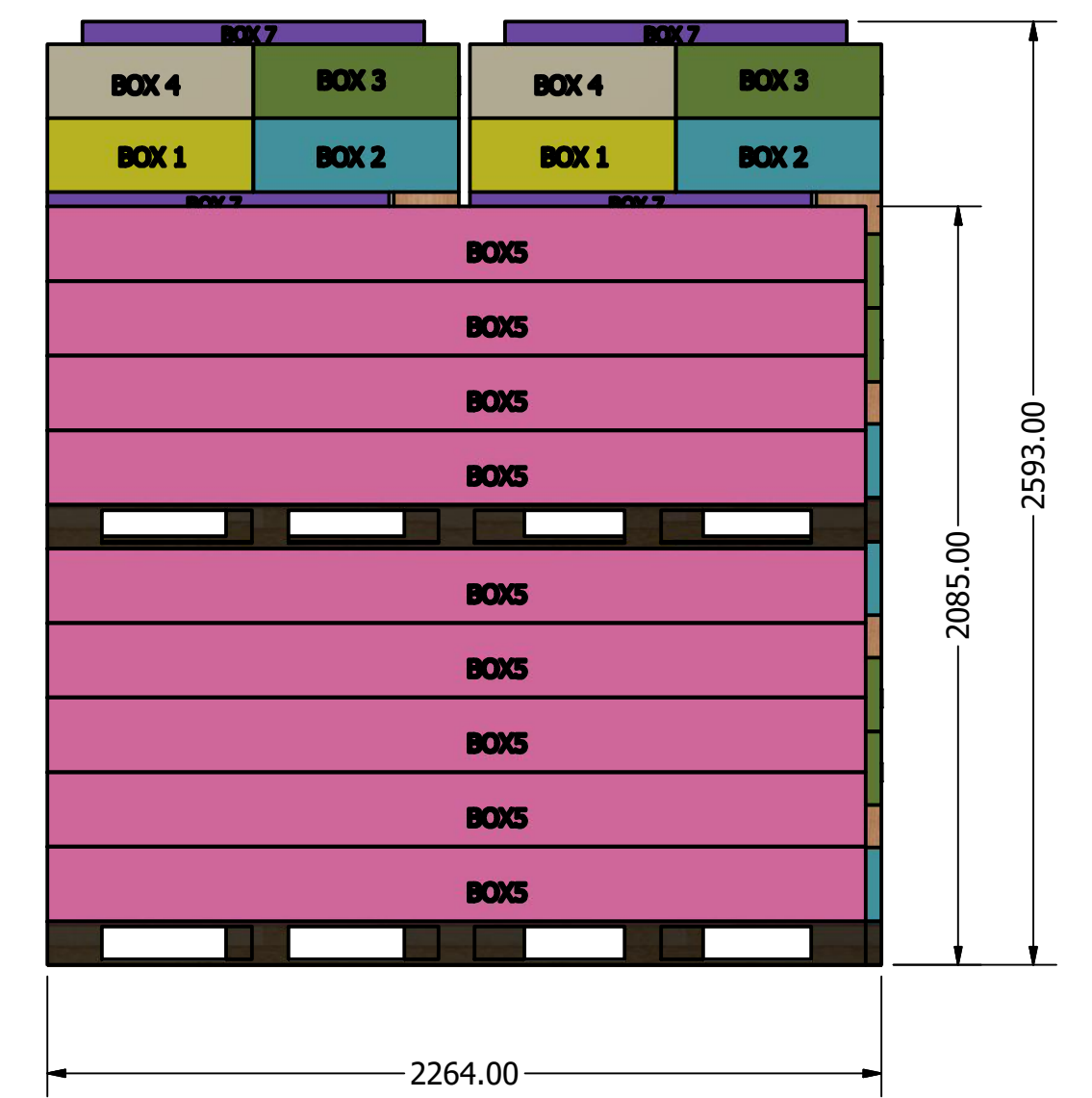

DRAWN Rudy		TITLE		
CHECKED		TITLE		
QA		TITLE		
MFG		TITLE		
APPROVED		TITLE		
		SIZE D	DWG NO	REV
		SCALE 1 : 20	SHEET 1 OF 1	

# Pallet A

(Wood kit \*2)

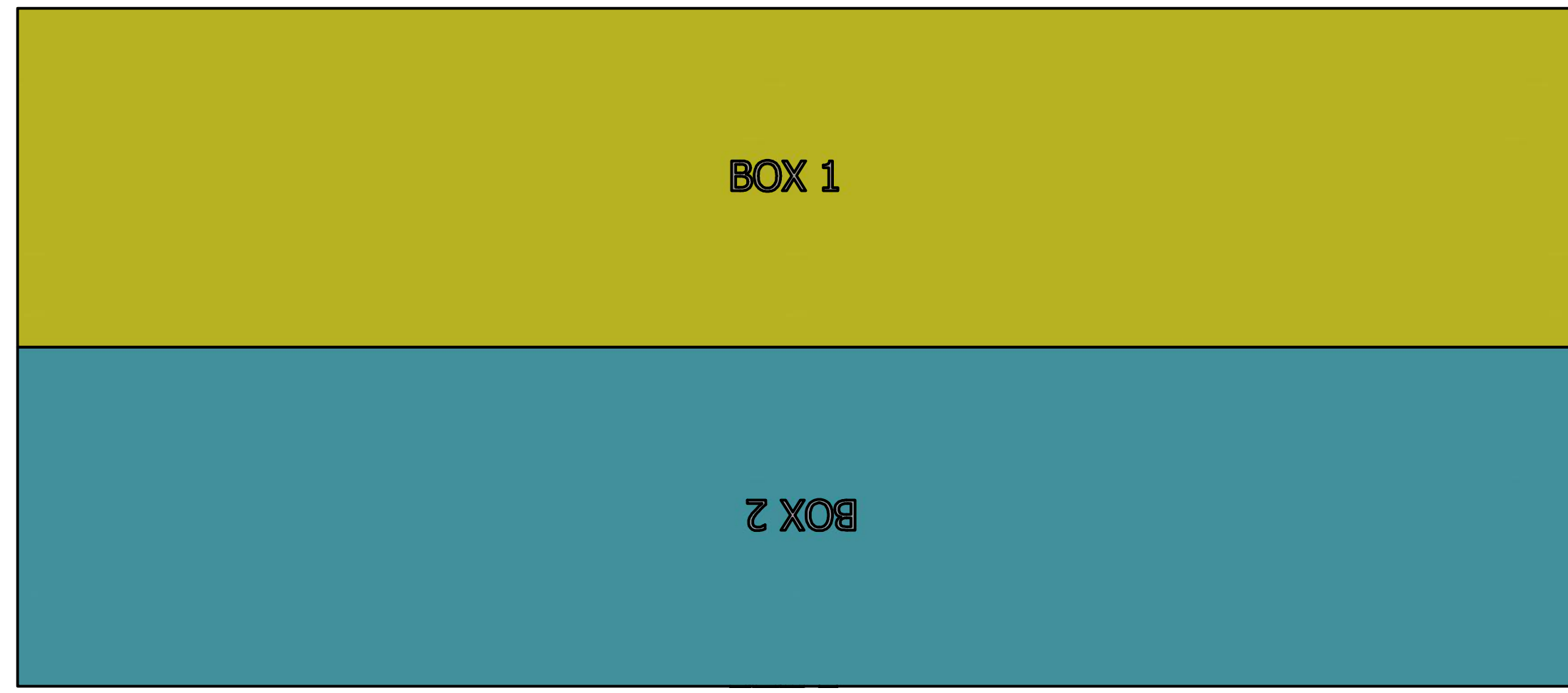

Plywood block \* 6  
 胶合板块\*6  
 180mm\*90mm\*116mm

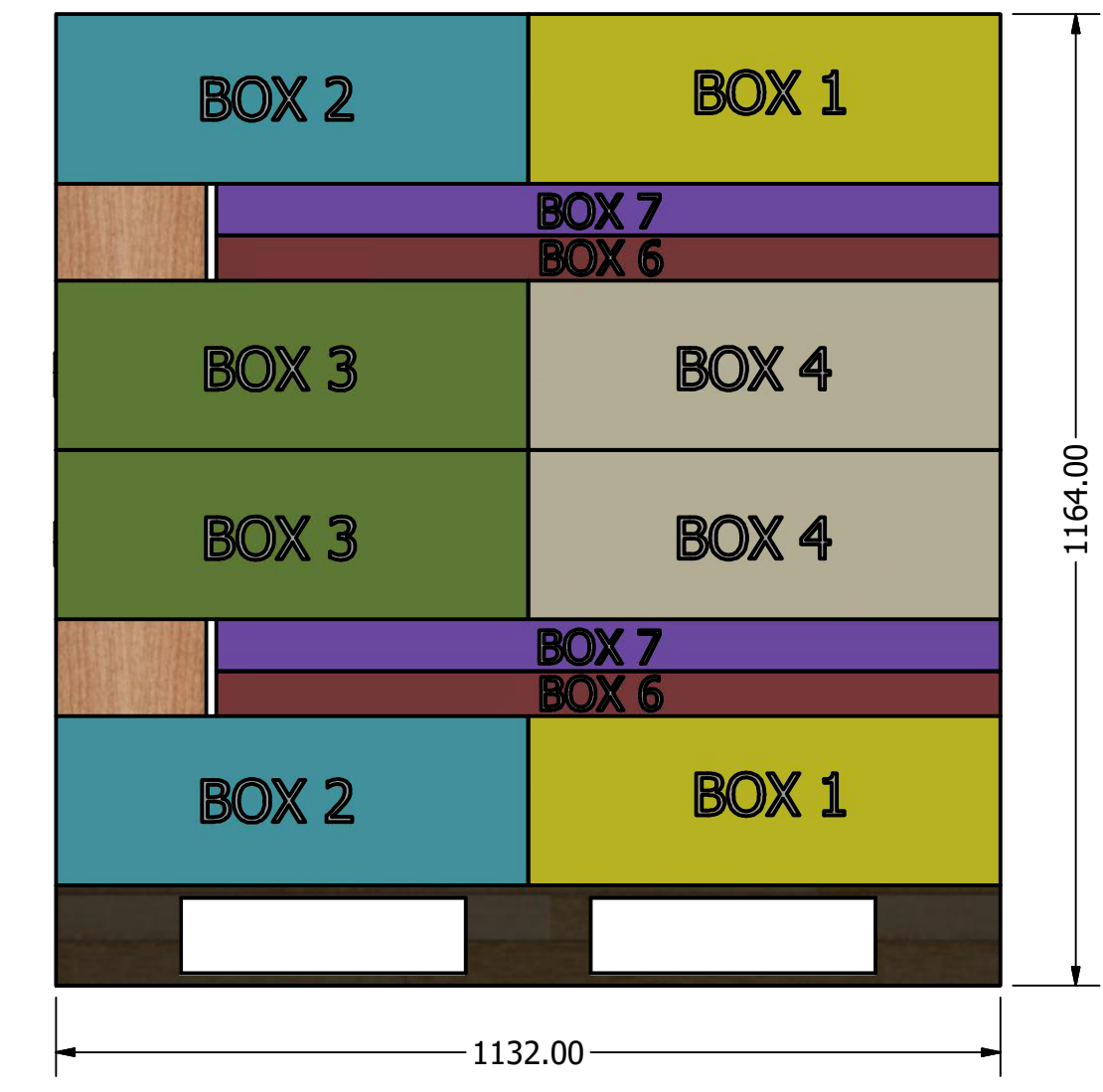
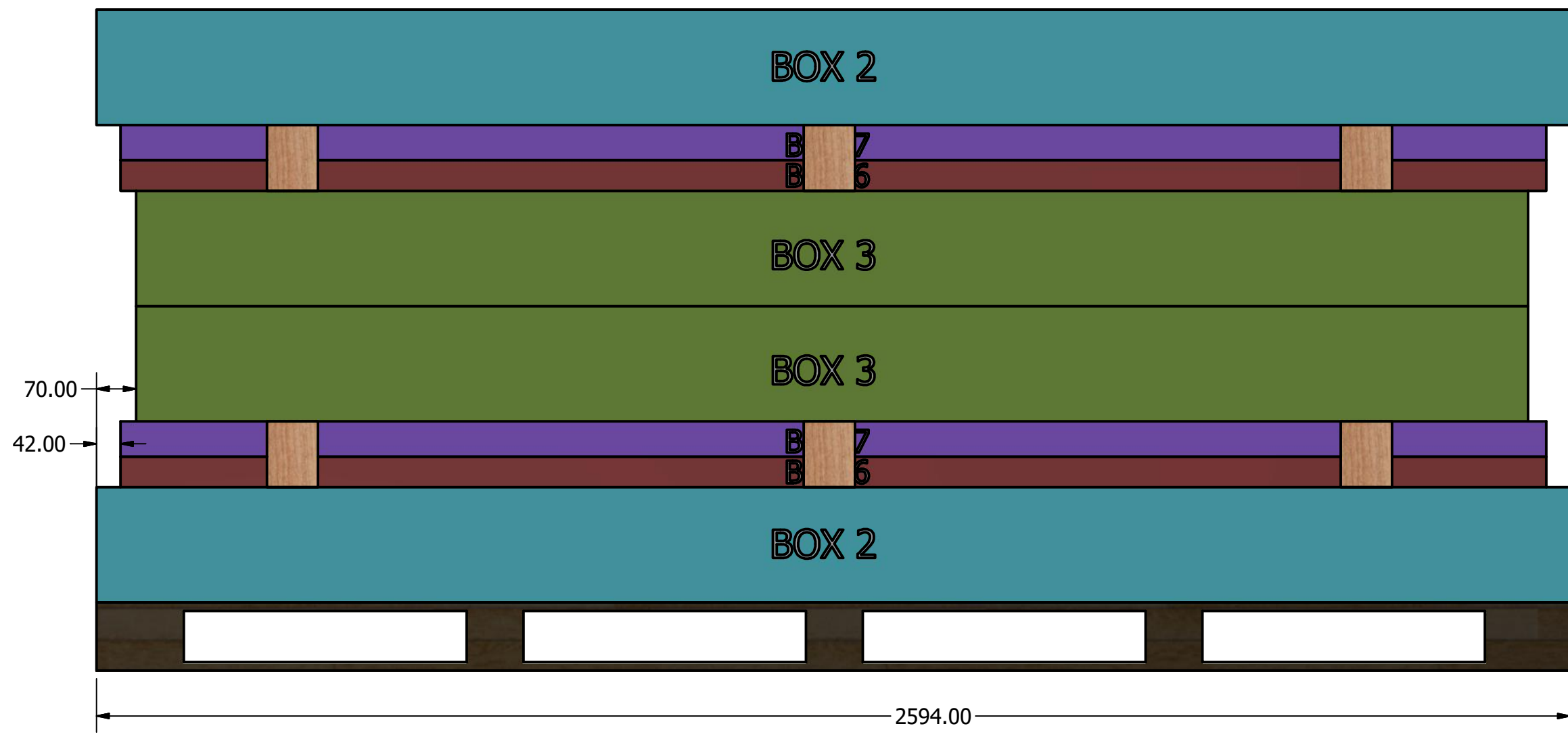
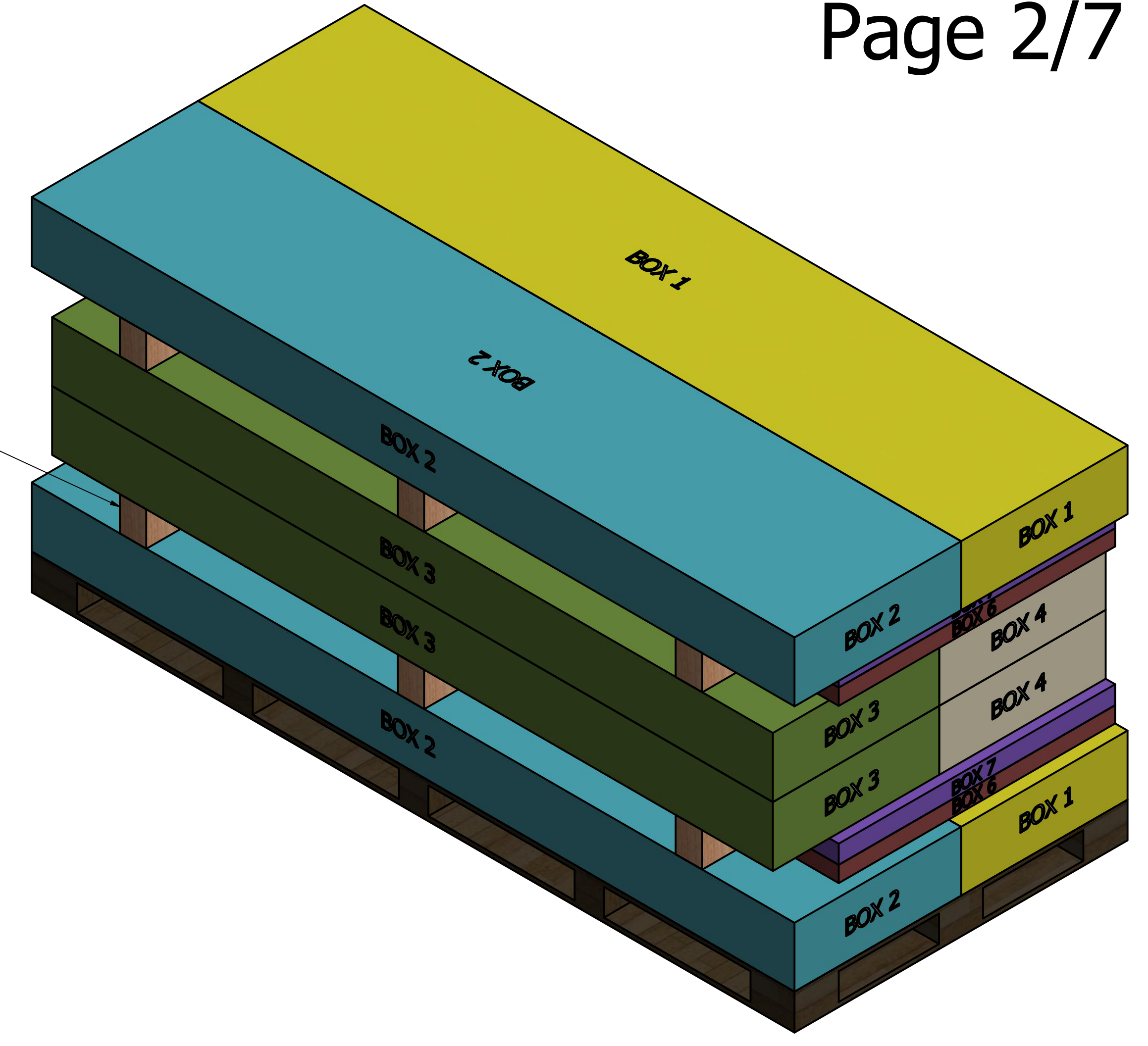

DRAWN Rudy		TITLE	
CHECKED			
QA			
MFG			
APPROVED			
		SIZE D	DWG NO Pallet A
		SCALE 1 / 9	REV
		SHEET 1 OF 1	

# Pallet B

(Wood kit \*2 +BOX1\*1+BOX2 \*1+ BOX6\*1)

Plywood block \* 6  
 胶合板块\*6  
 180mm\*90mm\*116mm

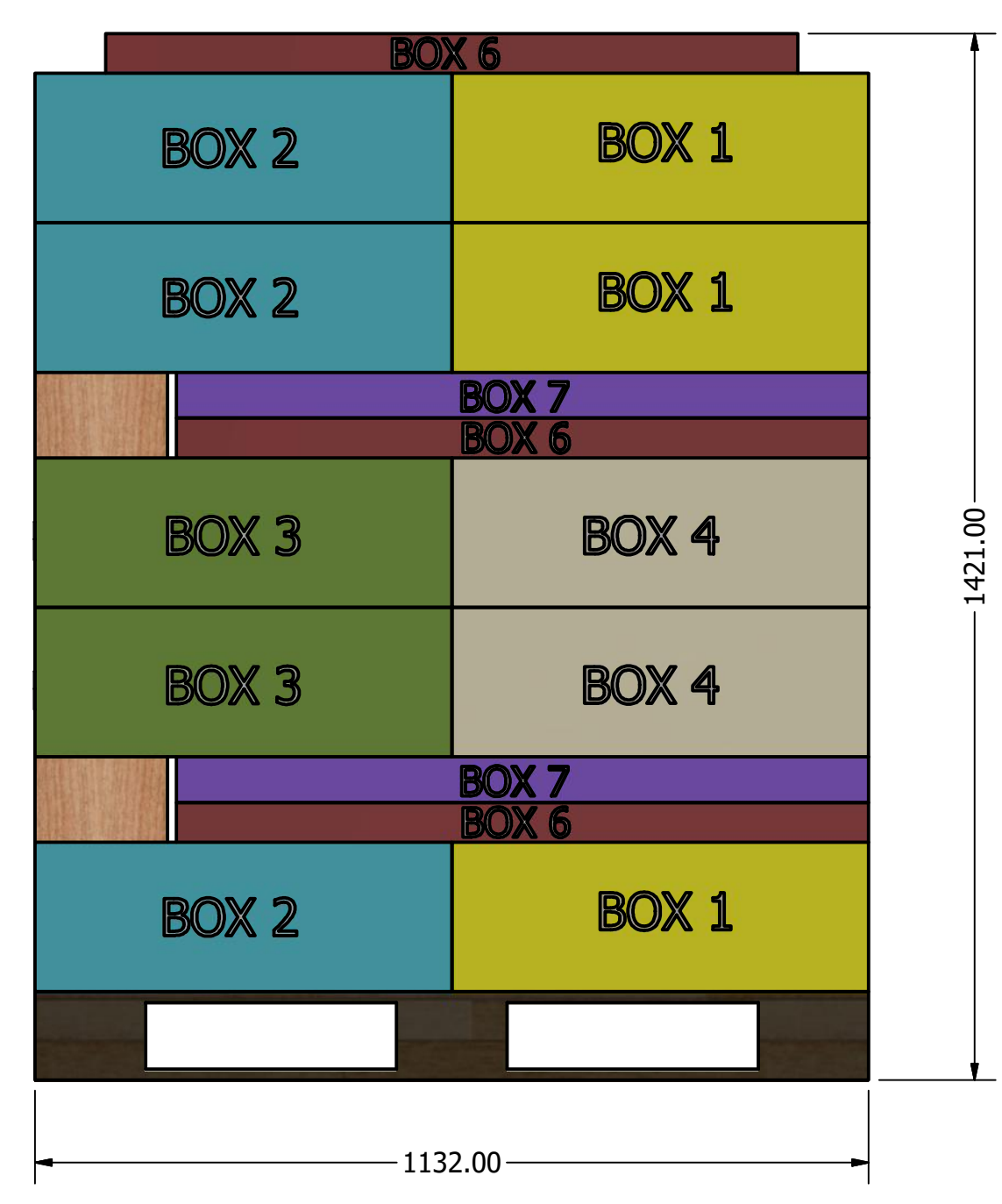
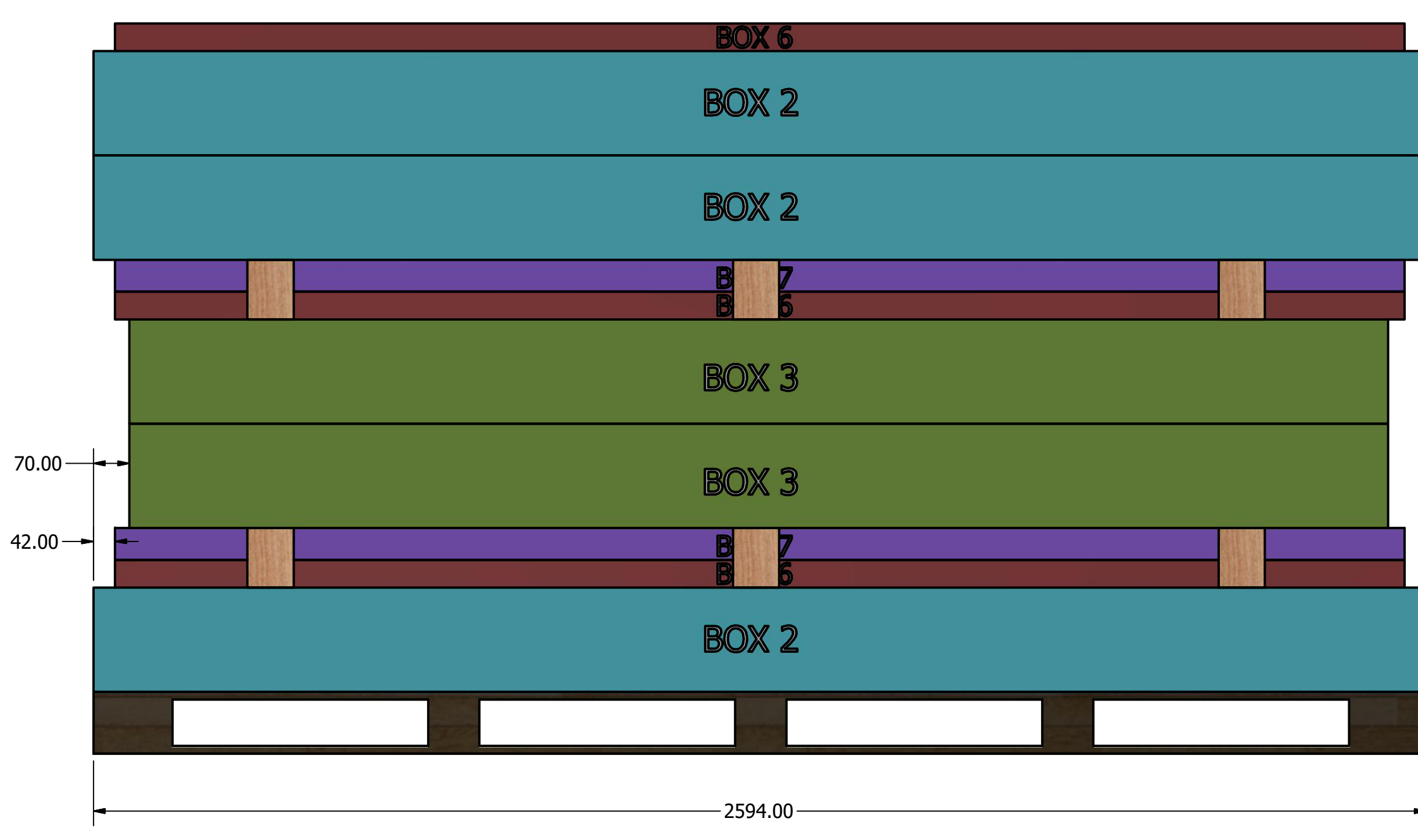
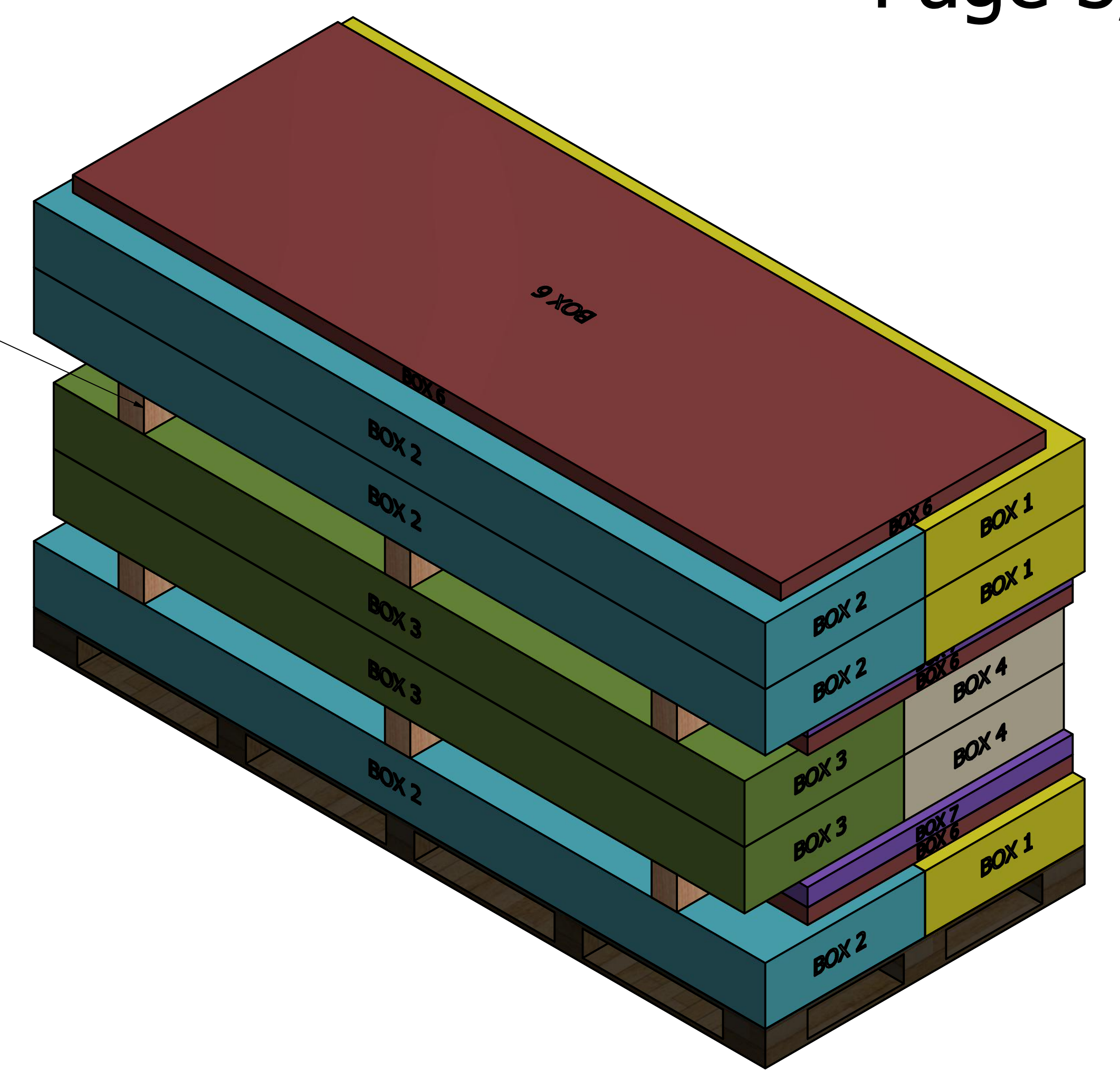

DRAWN Rudy		TITLE	
CHECKED			
QA			
MFG			
APPROVED			
		SIZE D	DWG NO Pallet A
		SCALE 1 : 9	REV
		SHEET 1 OF 1	

# Pallet C

(Wood kit \*2 +BOX3\*1+BOX4 \*1+ BOX7\*1)

Plywood block \* 6  
 胶合板块\*6  
 180mm\*90mm\*116mm

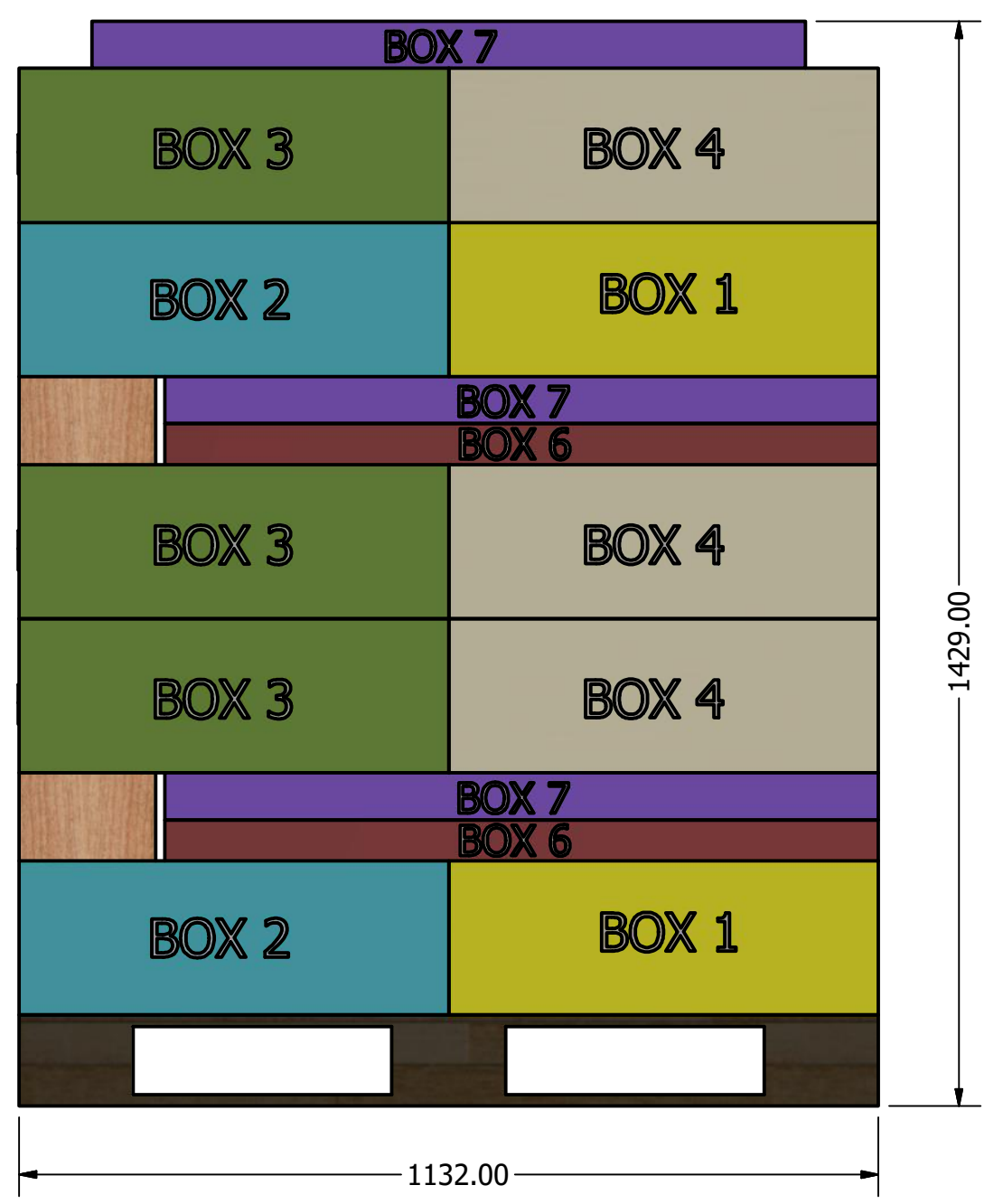
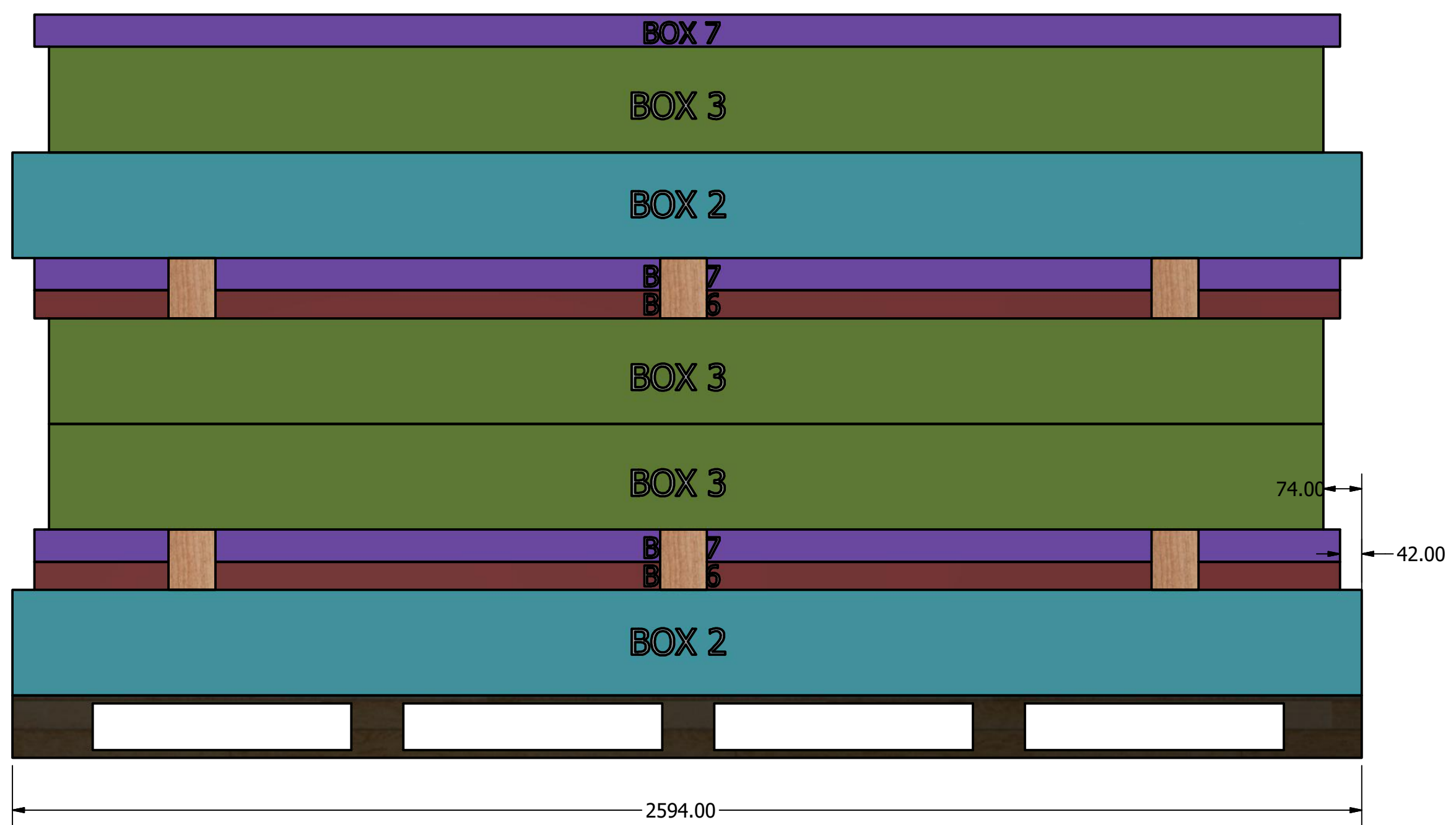
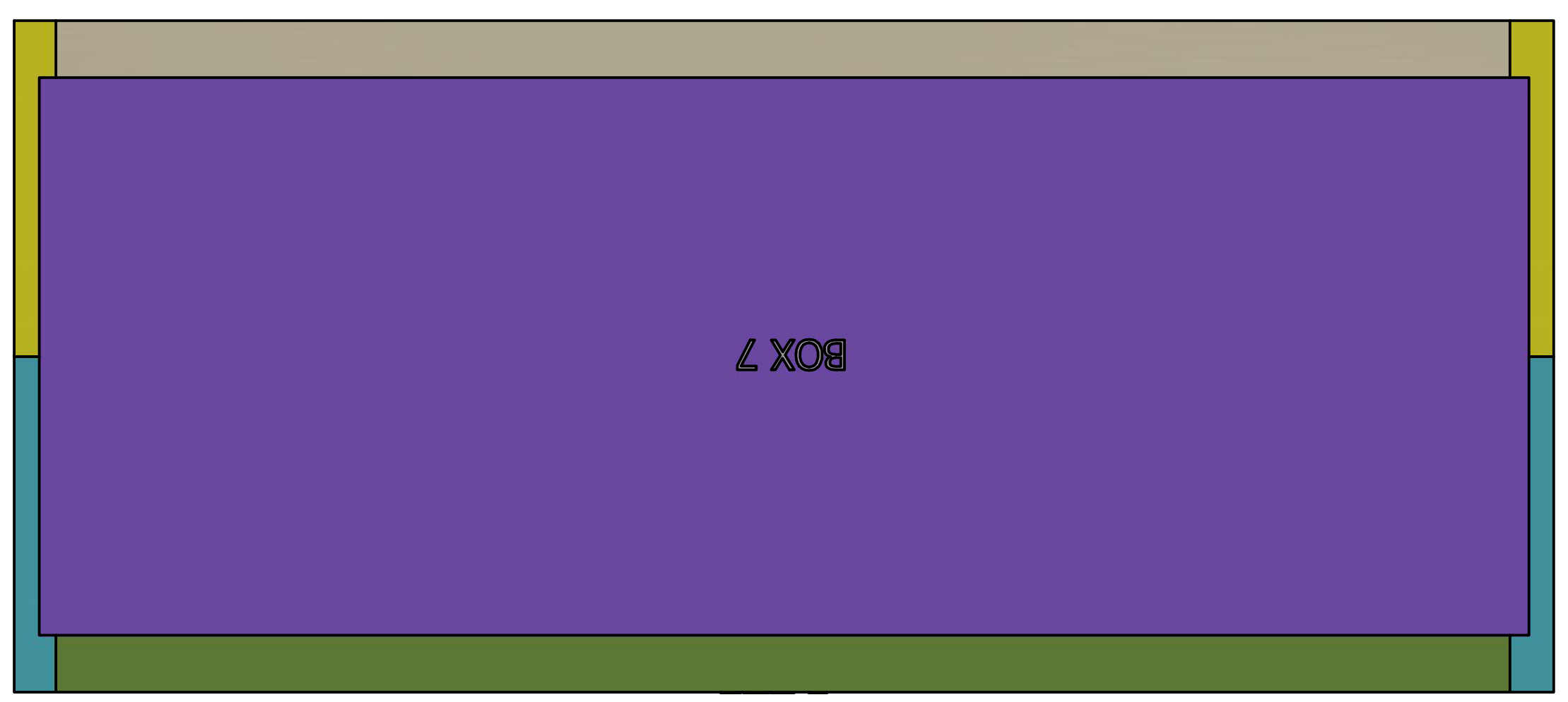
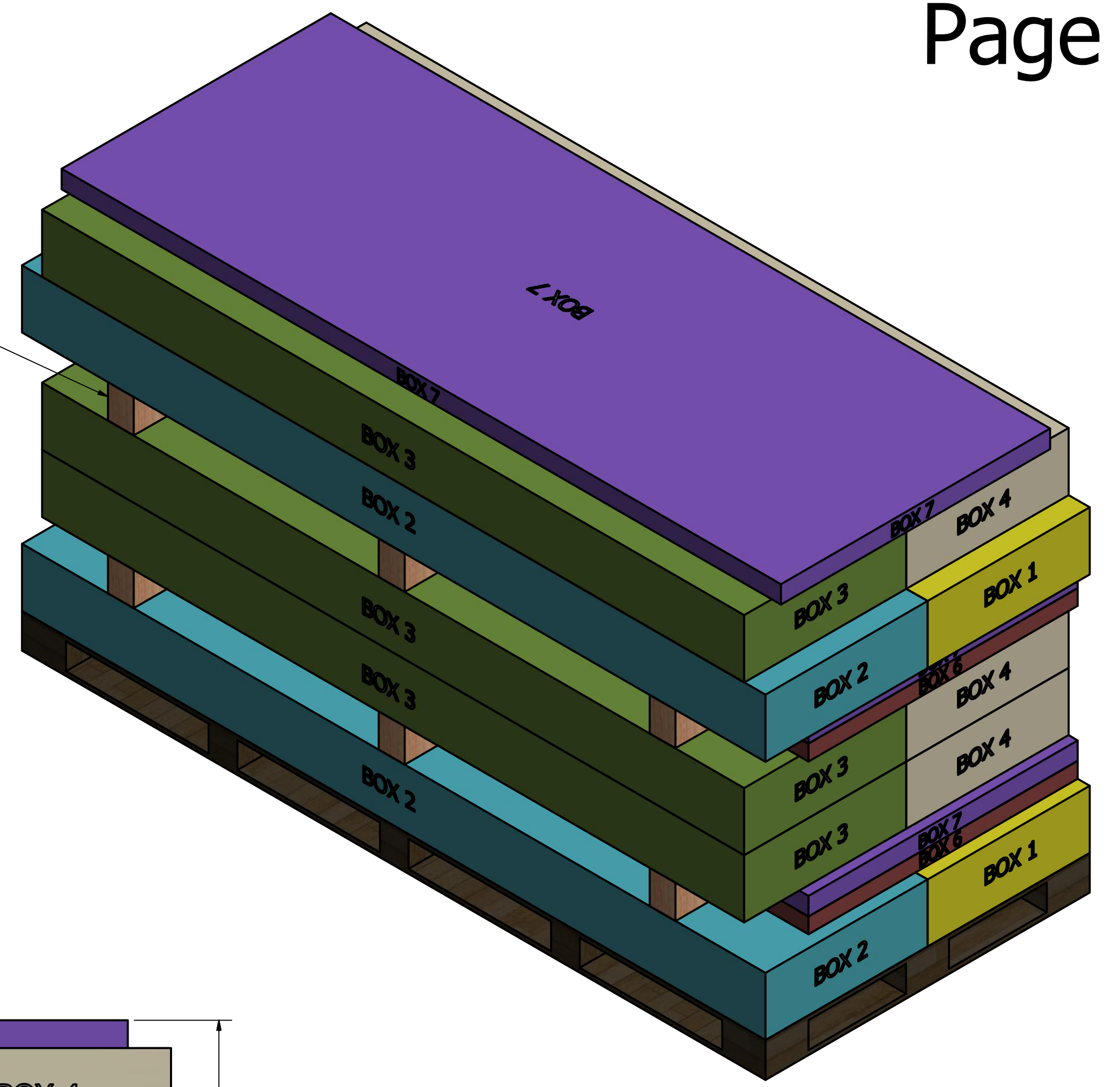

DRAWN Rudy		TITLE	
CHECKED			
QA			
MFG			
APPROVED			
		SIZE D	DWG NO Pallet A
		SCALE 1: 9	REV
		SHEET 1 OF 1	

# Pallet D

(BOX5\*16)

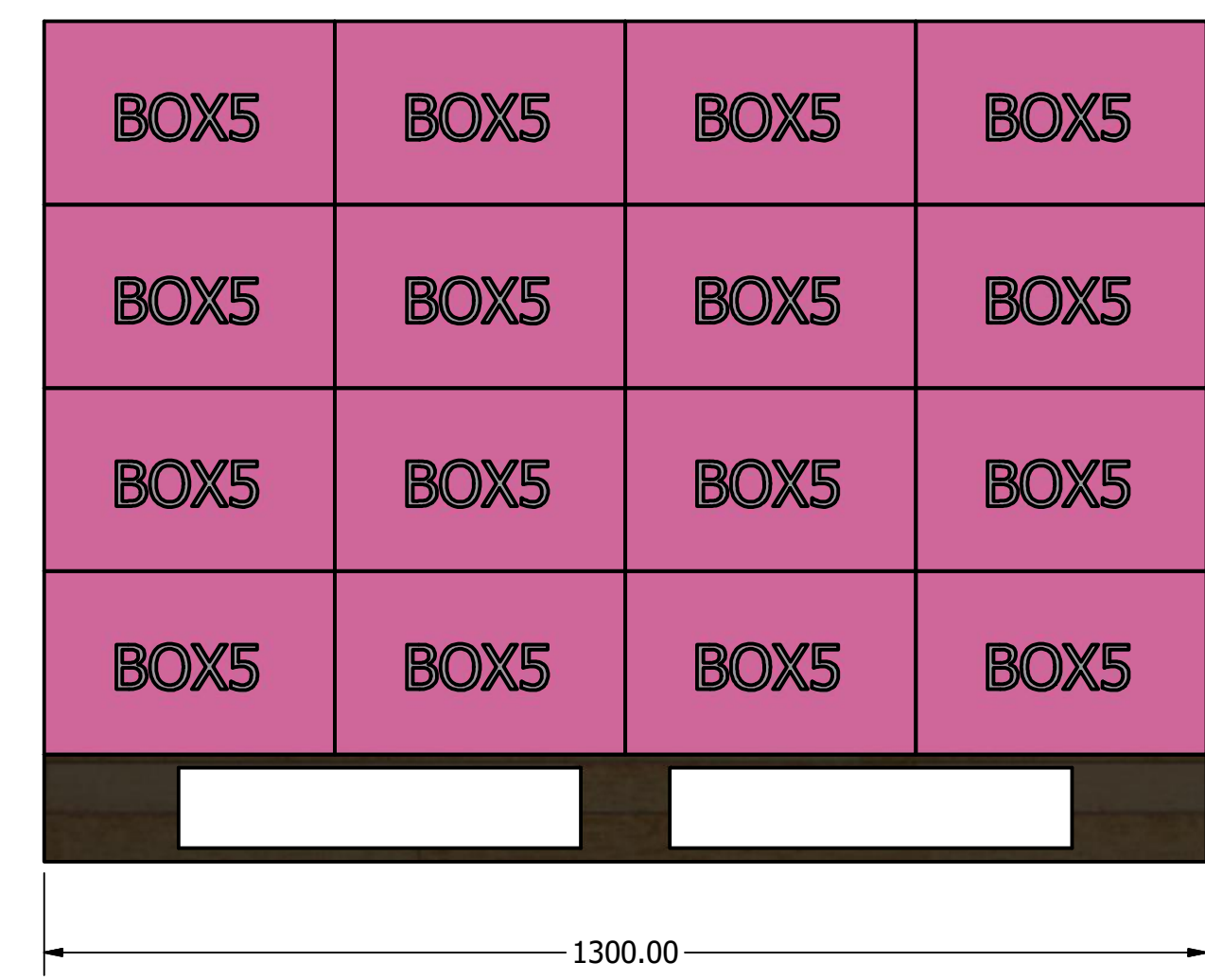
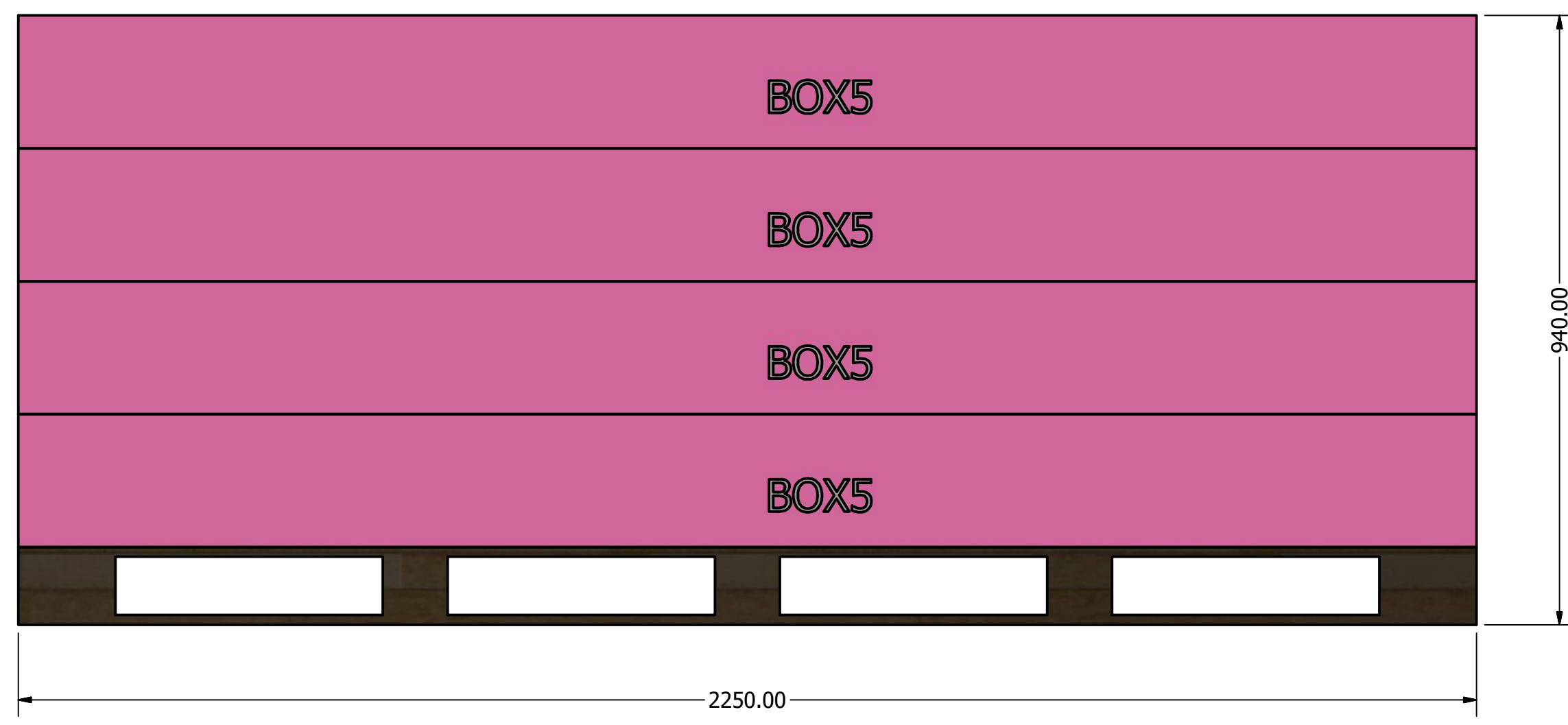
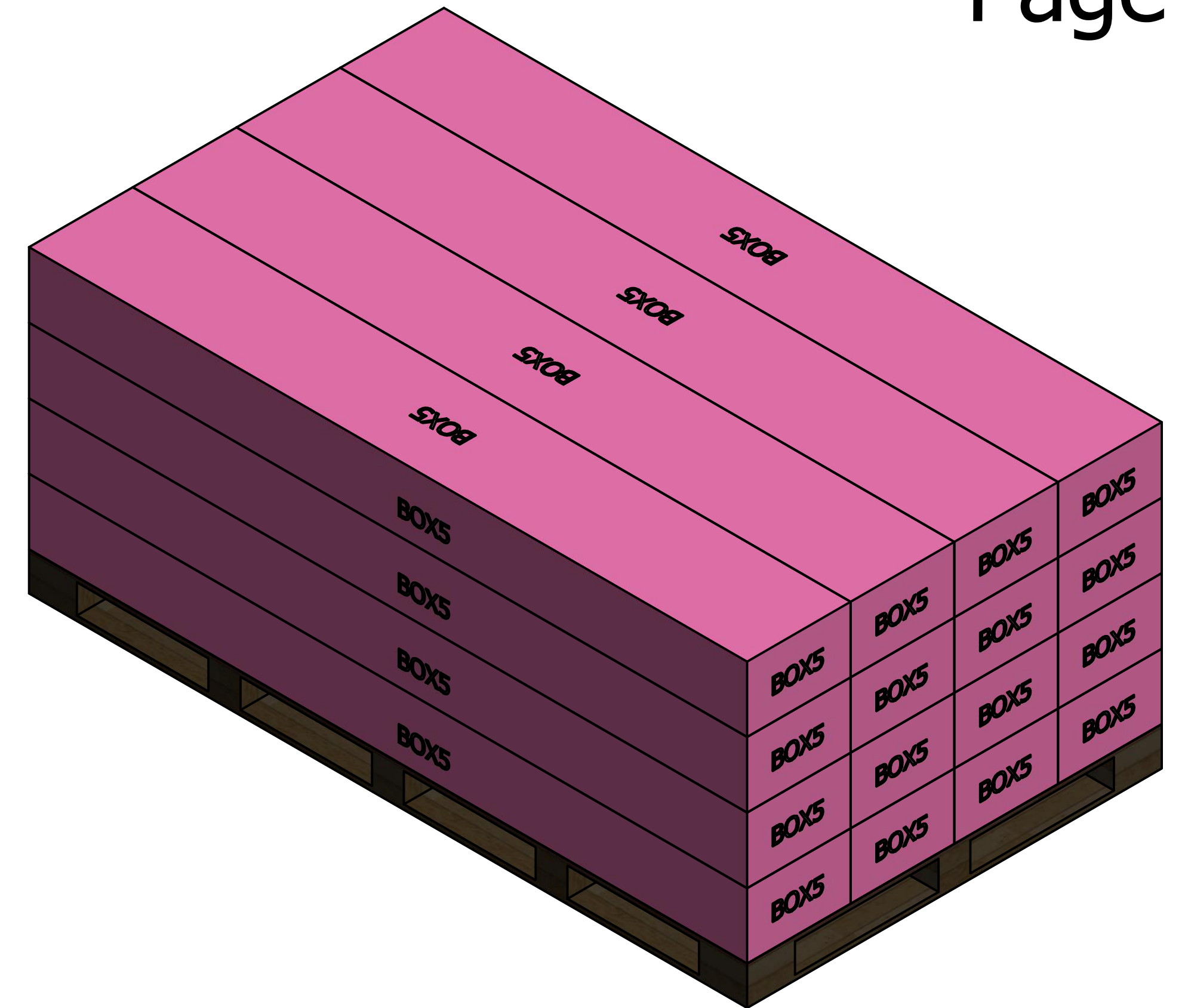
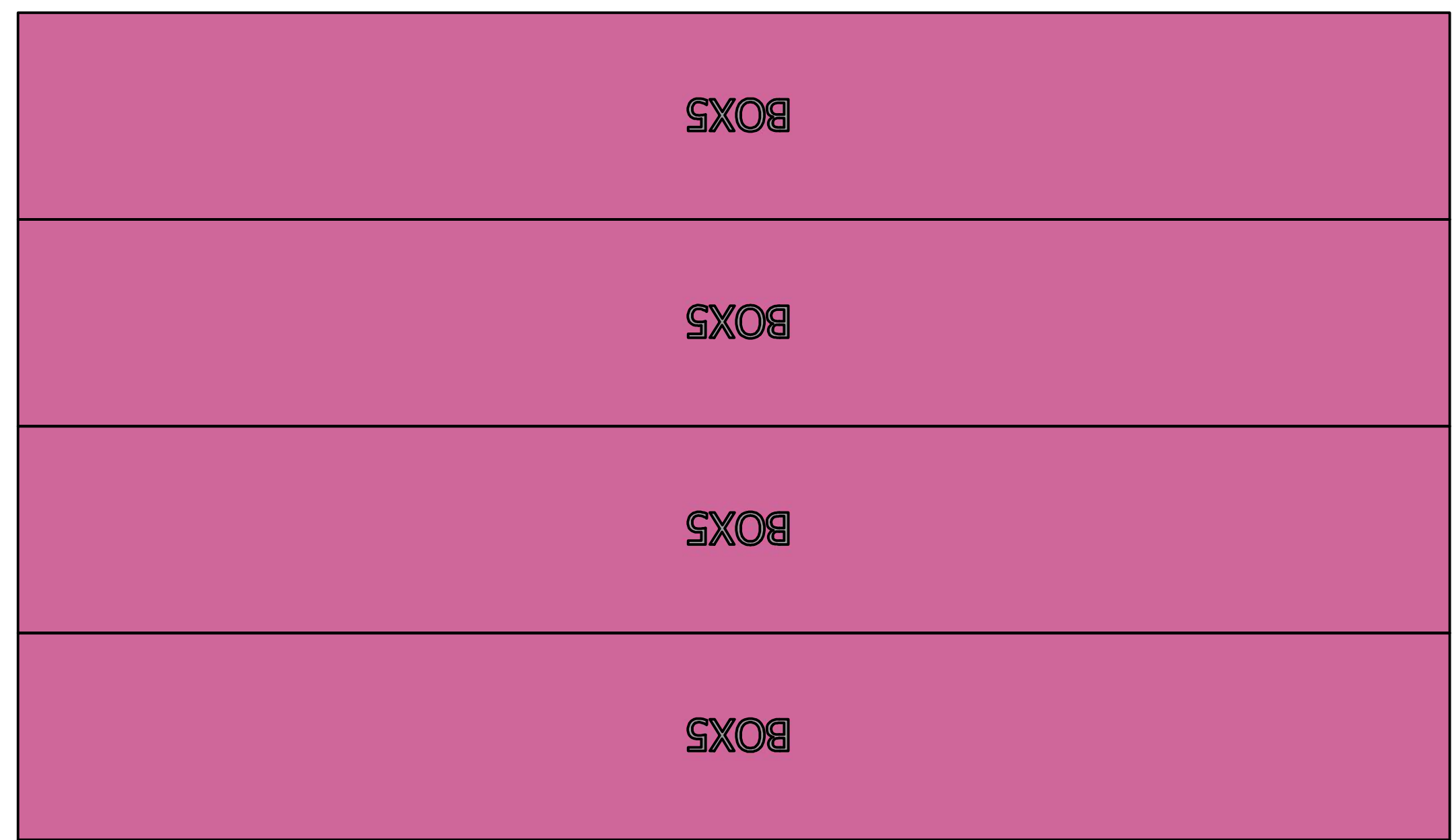

DRAWN Rudy		TITLE		
CHECKED				
QA				
MFG				
APPROVED		SIZE D	DWG NO Pallet A	REV
		SCALE 1 : 8	SHEET 1 OF 1	

# Pallet E

(BOX5\*20)

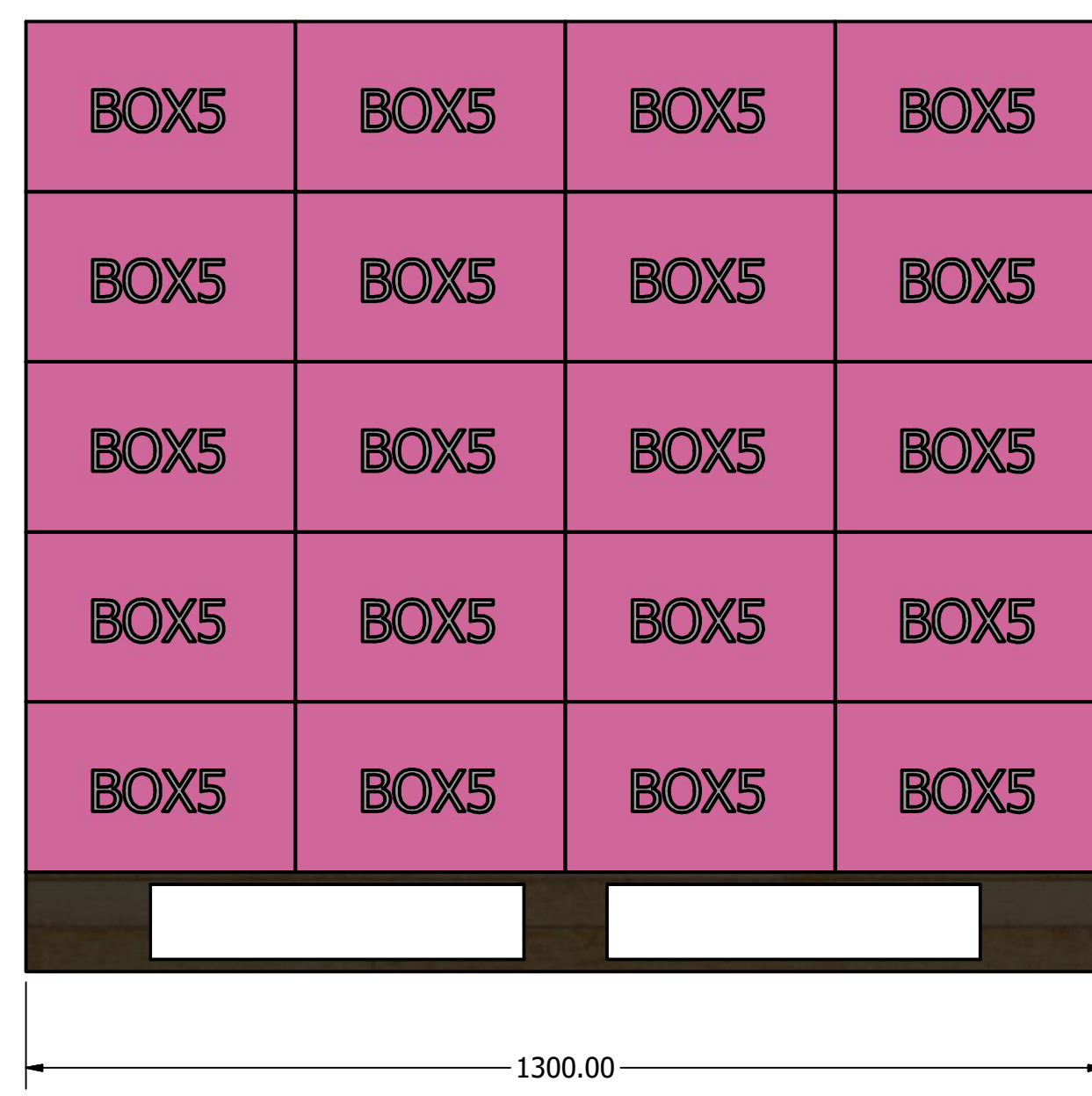
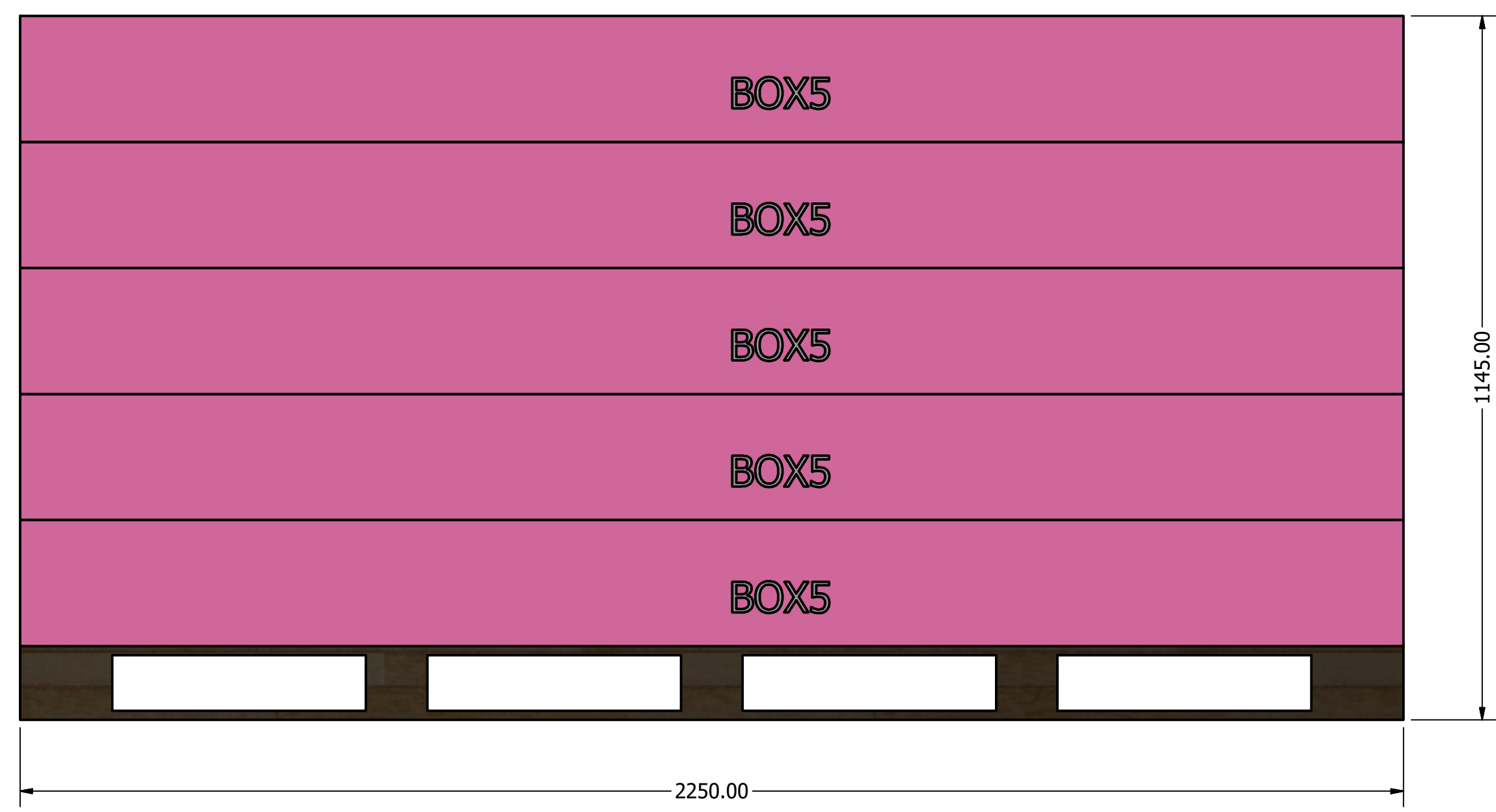
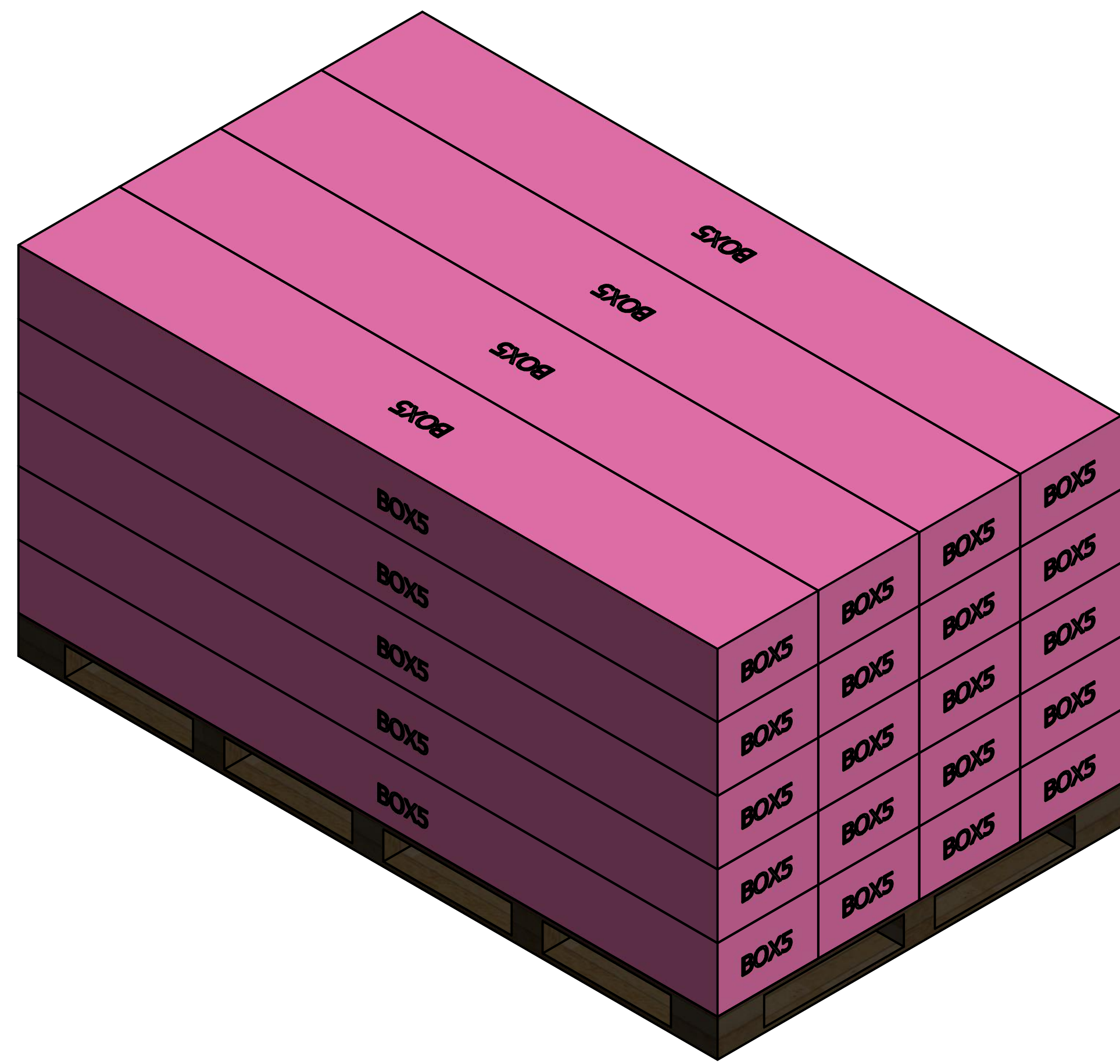
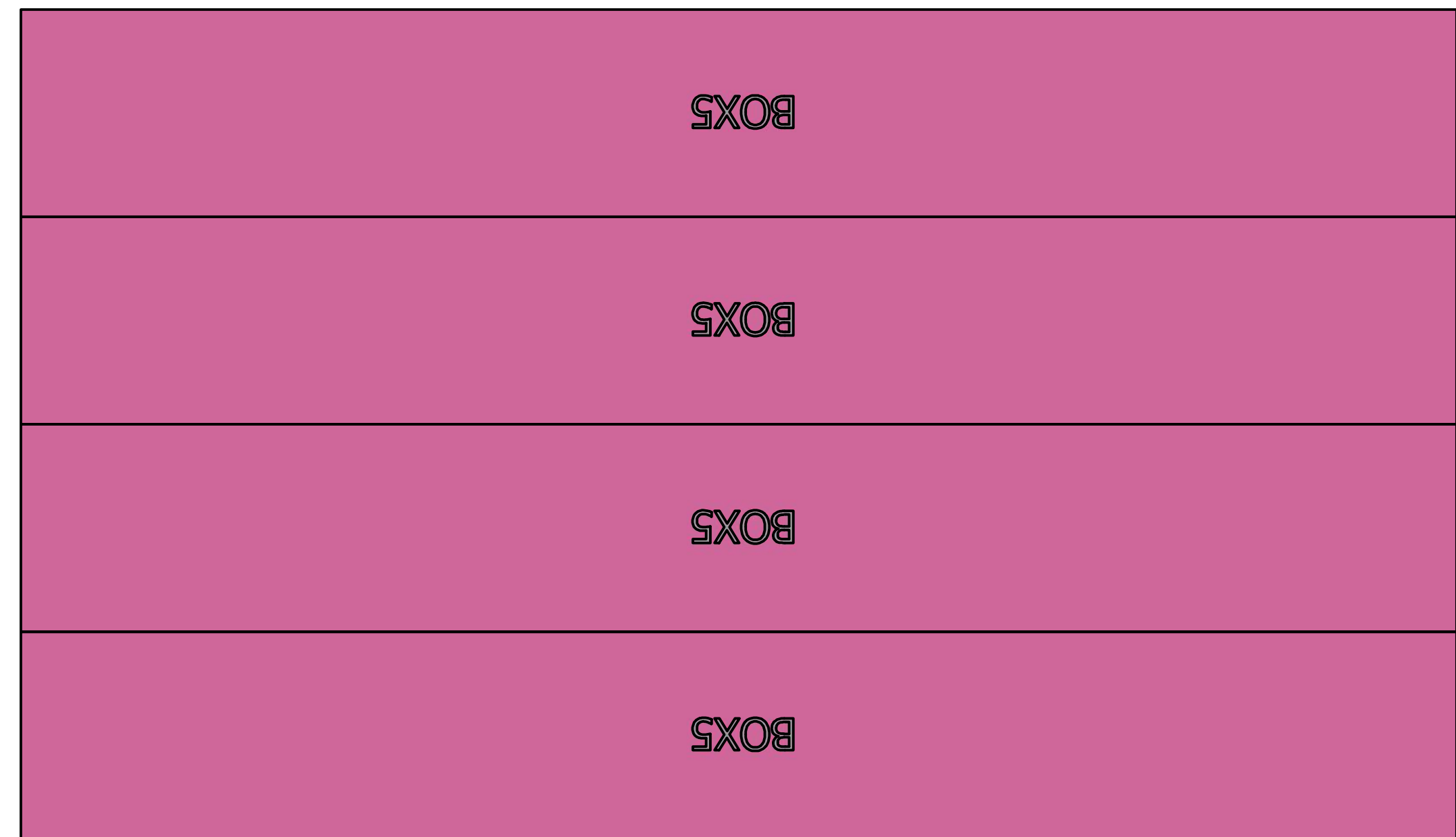

DRAWN Rudy		TITLE	
CHECKED			
QA			
MFG			
APPROVED			
		SIZE D	DWG NO Pallet A
		SCALE 1 : 8	REV
		SHEET 1 OF 1	

BOX1

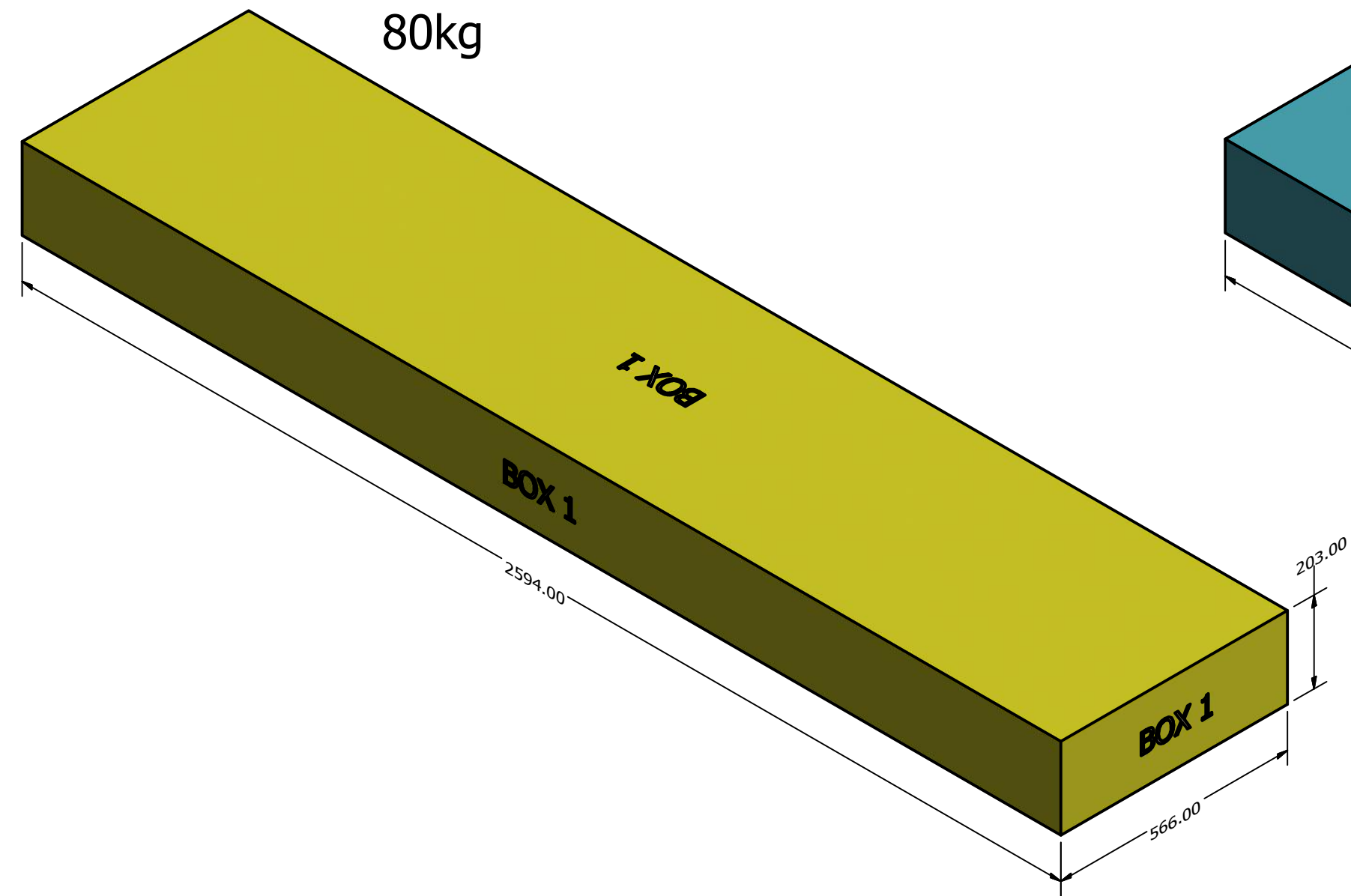

BOX2

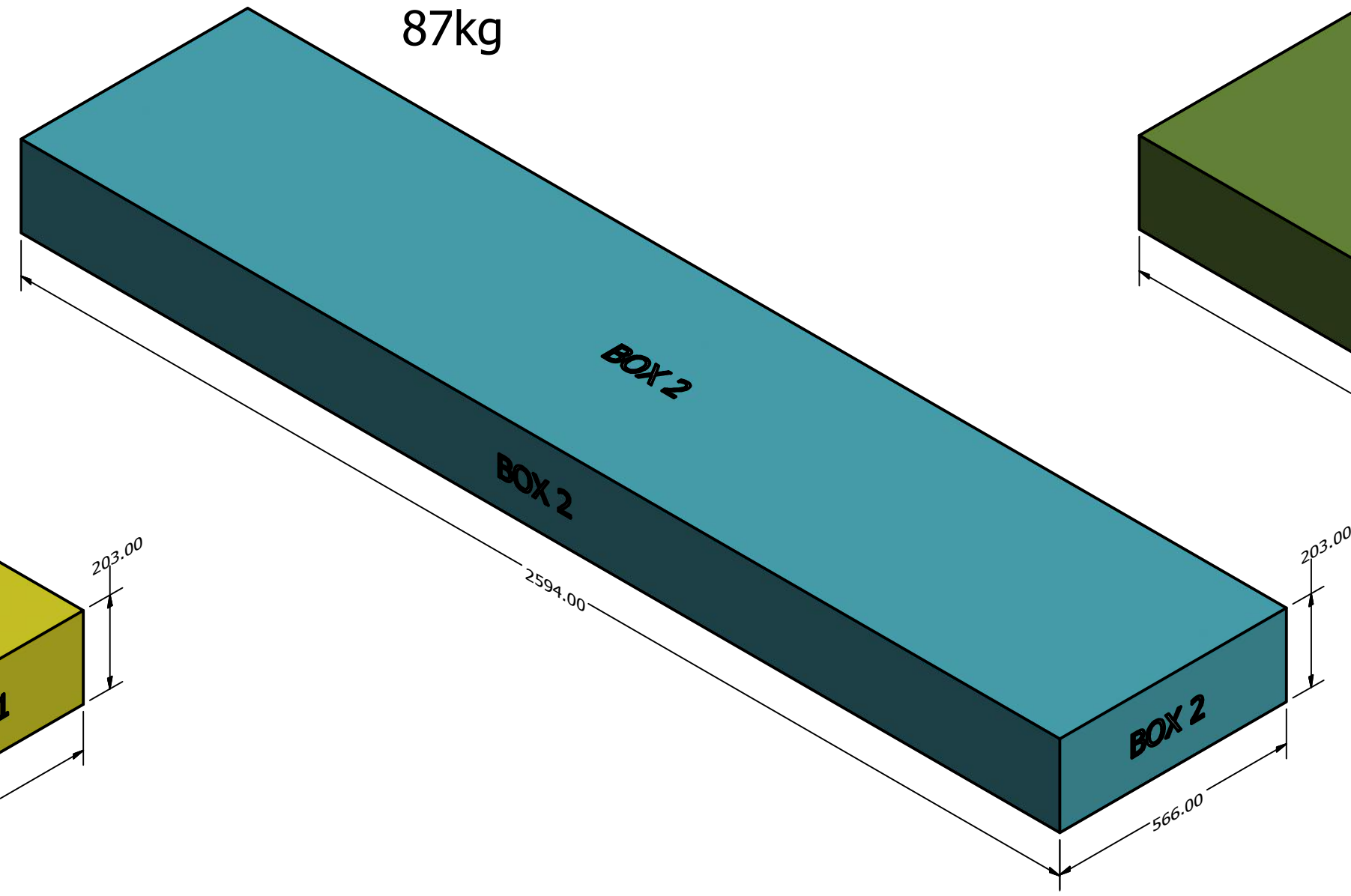

BOX3

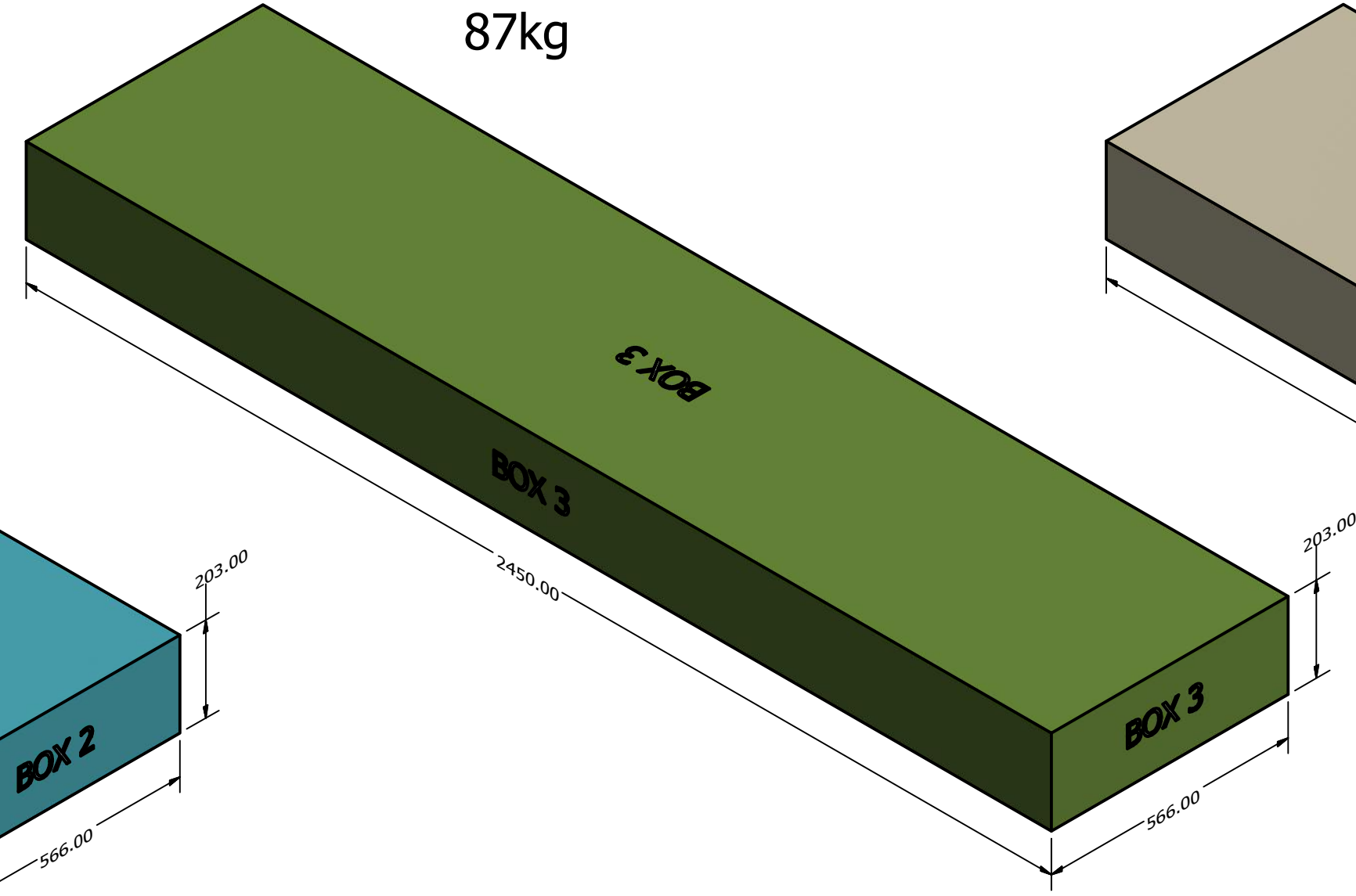

BOX4

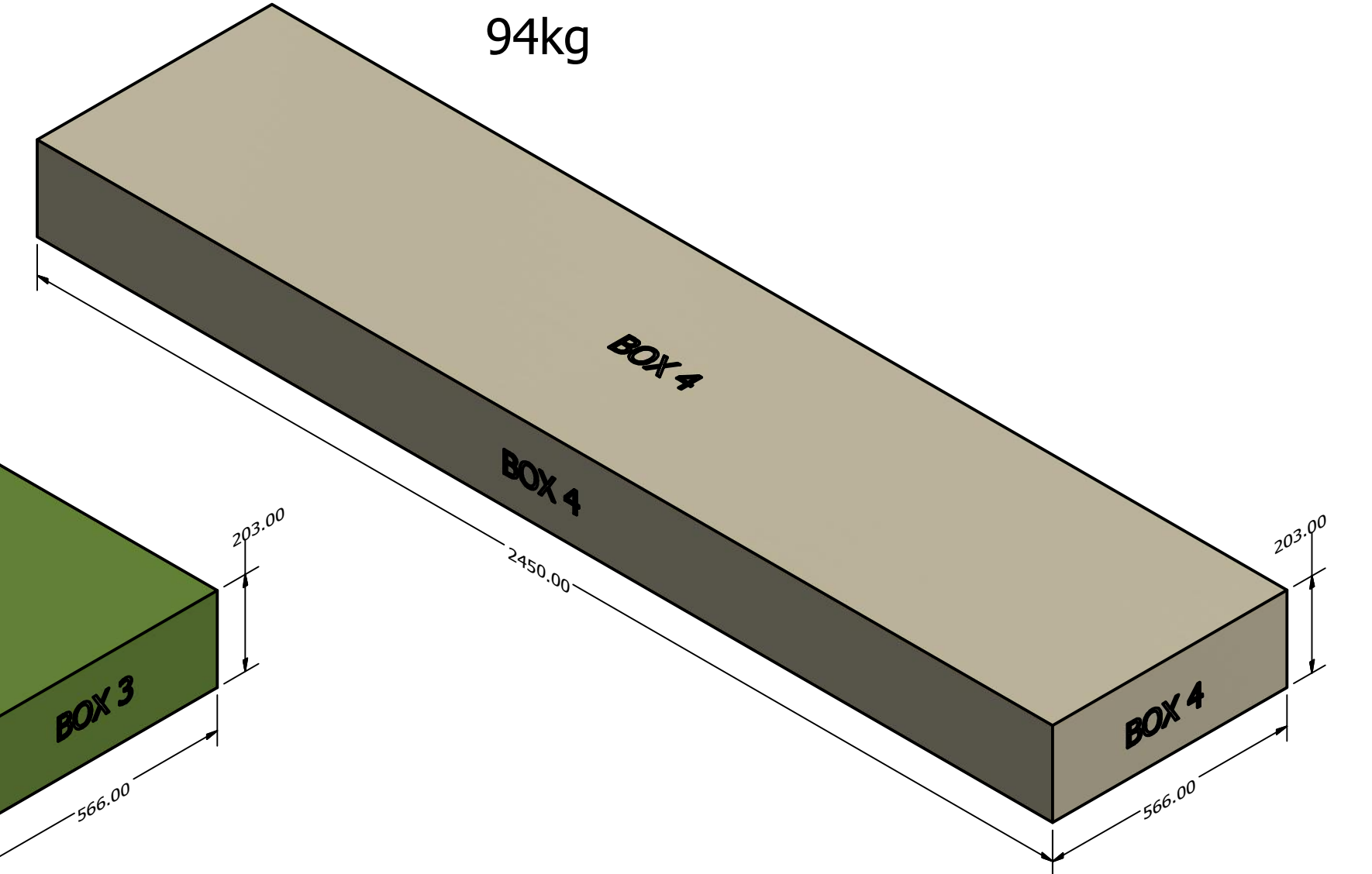

BOX5

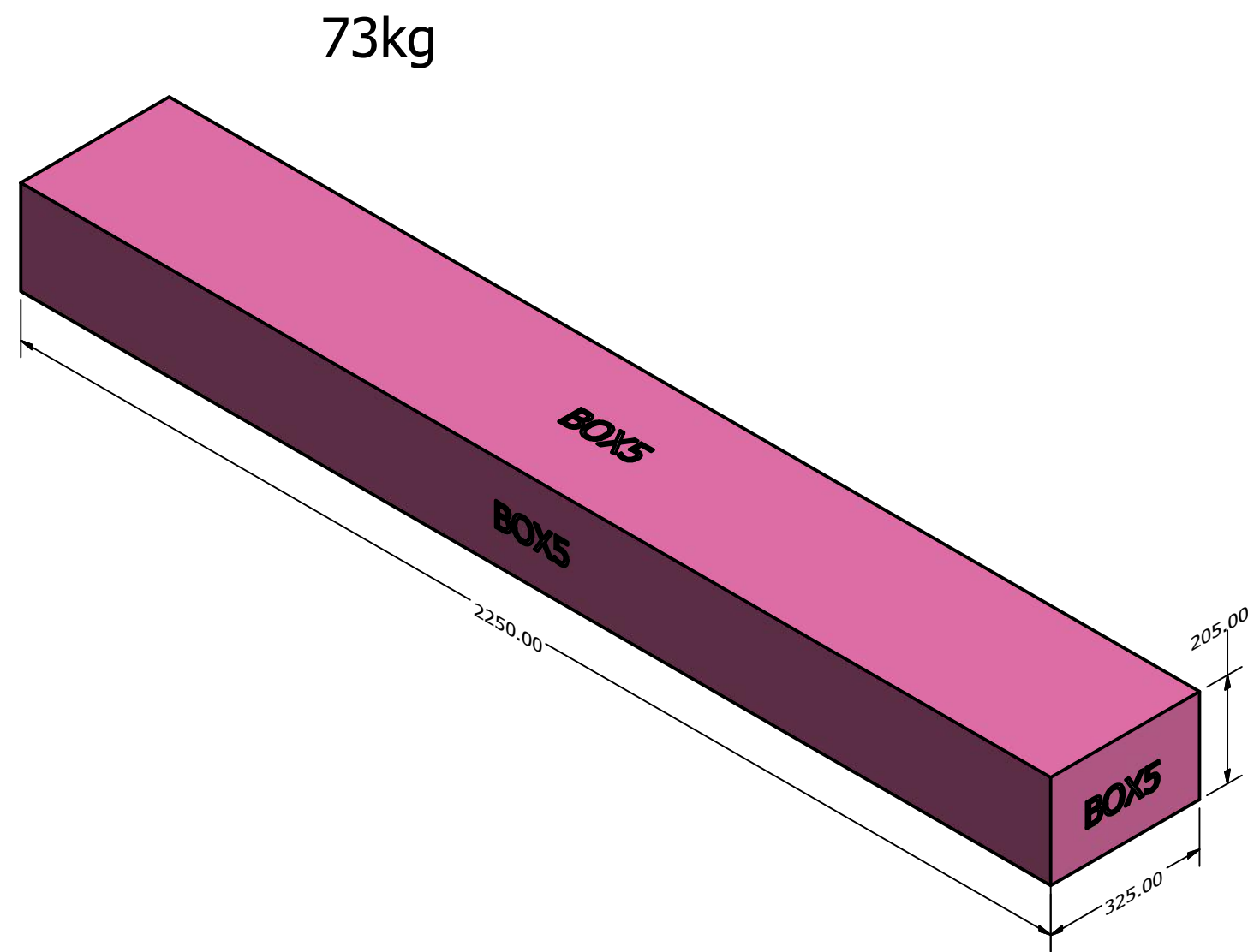

BOX6

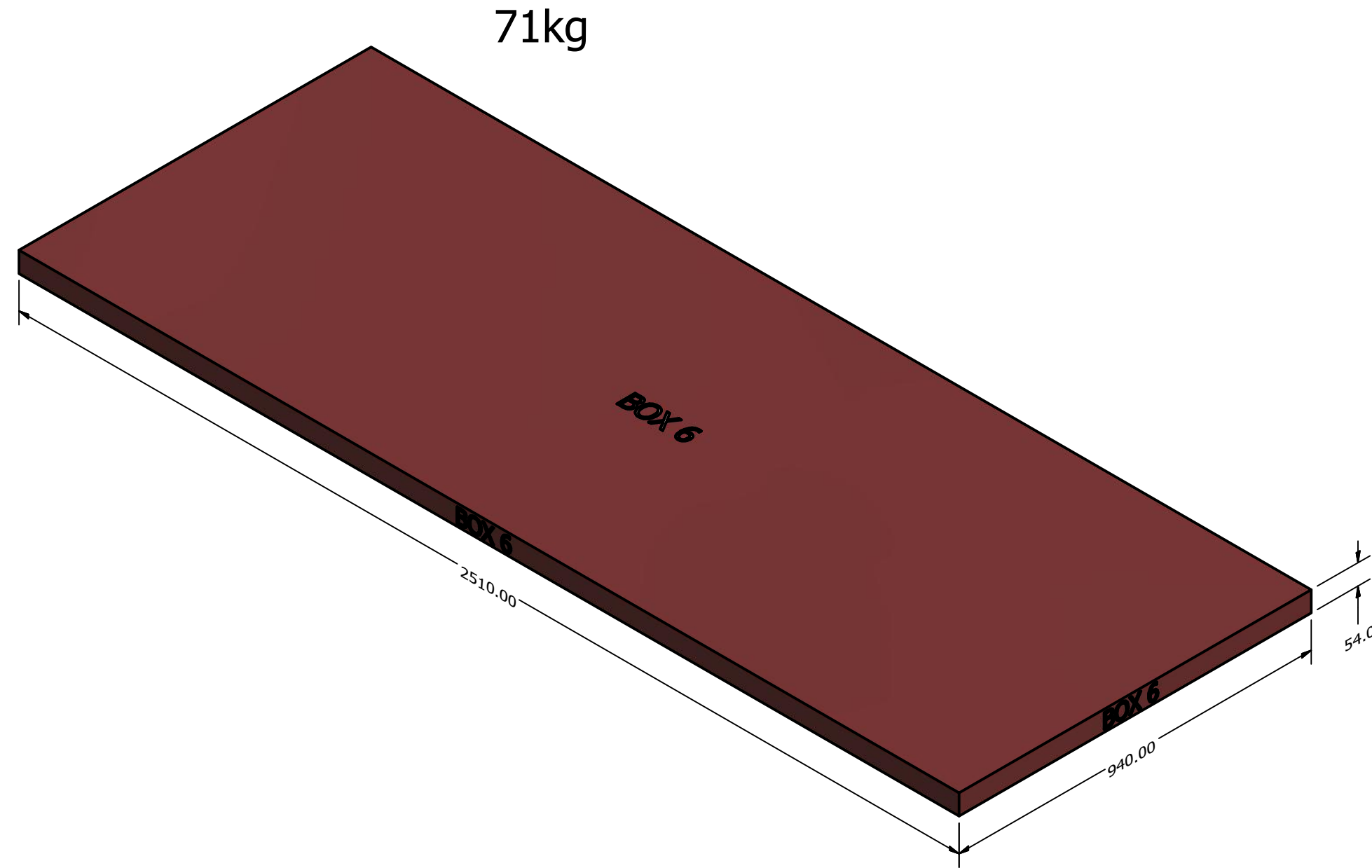

BOX7

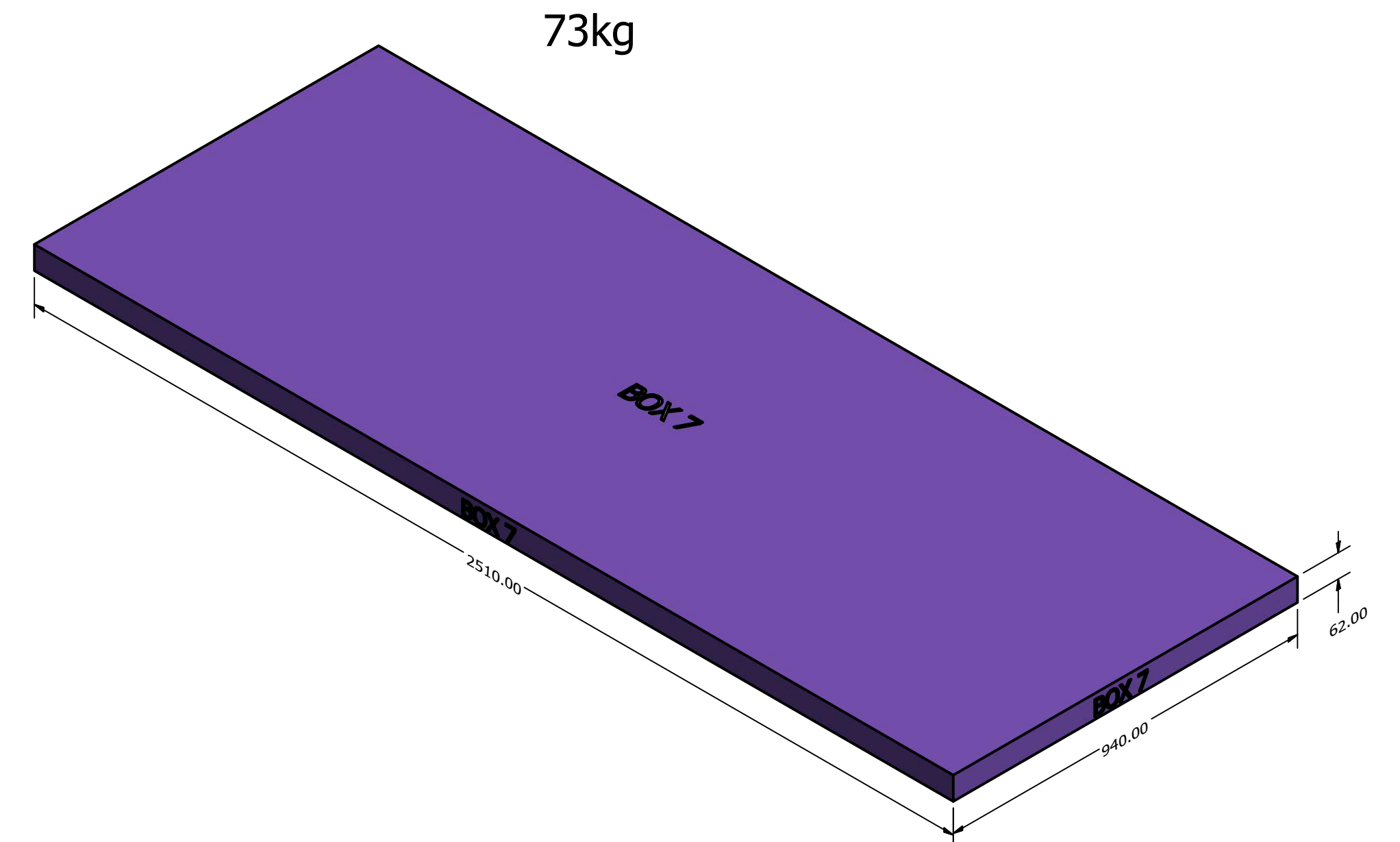

DRAWN Rudy	2019-12-16		
CHECKED		TITLE	
QA			
MFG			
APPROVED			
		SIZE D	DWG NO BOXES
		SCALE 1 / 10	REV
		SHEET 1 OF 1	