

ASSEMBLY INSTRUCTIONS

RATTAN ACCENT CHAIR

A Seat

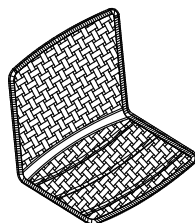

1pc

B Leg

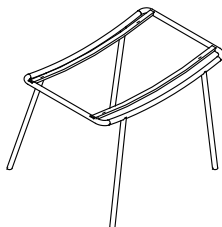

1pc

C Bolt
M6 x 20mm

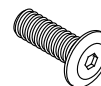

4pcs

D Allen Key
M4

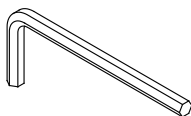

1pc

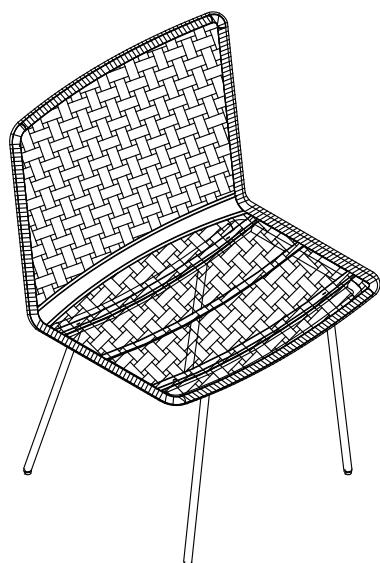

This page lists all the contents included in the box. Please take the time to identify the hardware as well as the individual components to this product. As you unpack and prepare for assembly, place the contents on a carpeted or padded area to protect them from damage.

1 Attach the Leg (B) to the Seat (A) using Bolt (C) with the Allen Key (D).

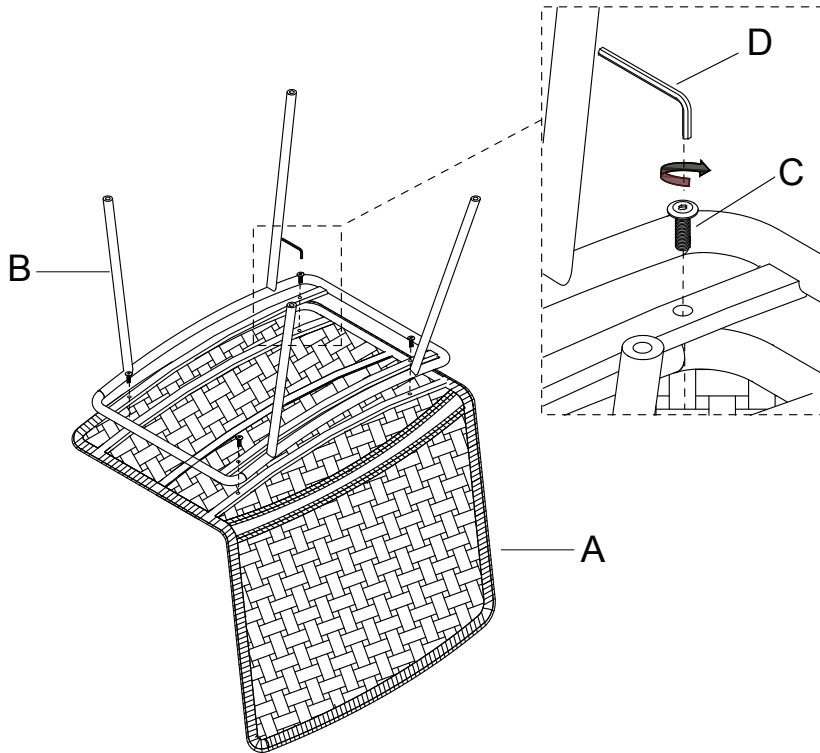

2 Adjust the height of the pre-installed levelers under the legs to achieve balance.

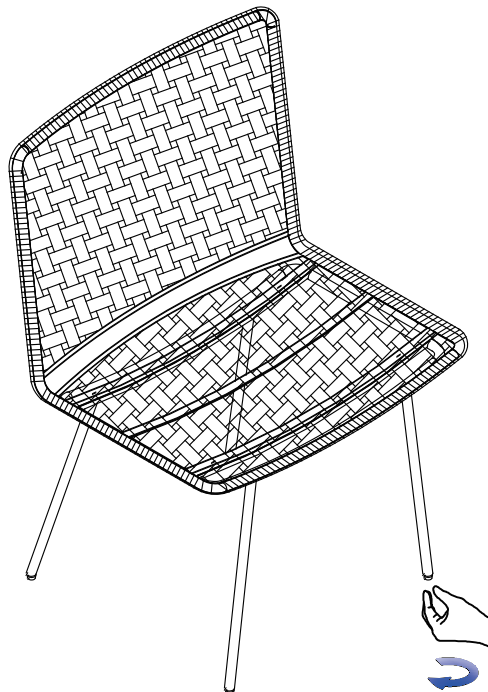

Cleaning & Care

Treat surfaces with care. Surfaces are resistant to scratches but are not scratch resistant. Clean surfaces with a dry or damp soft cloth. Do not use abrasive cleaners. Hardware may loosen over time. Periodically check that all connections are tight.