

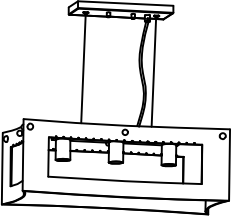

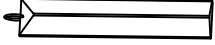



ASSEMBLY INSTRUCTION

CRYSTAL CHANDELIER

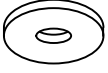
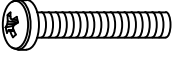
A Lamp Body  1pc	B Crystal Panel  48pcs	C Accessory Ø10x12mm  2pcs	D Flat Washer Ø12xØ4.5x1mm  2pcs
E Bolt Ø5/32"x1"  2pcs	F Wire Connector Ø9.9x17.7mm  2pcs	G Wire Connector Ø8.6x15.2mm  1pc	H Bulb E26  3pcs

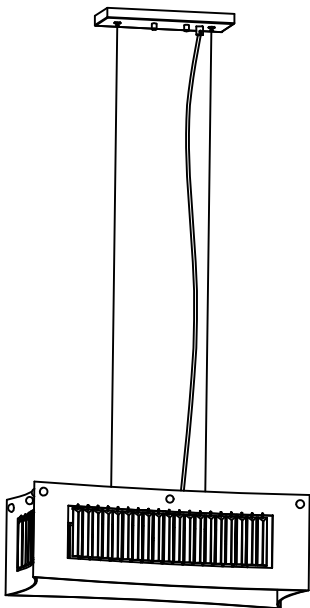

IMPORTANT SAFETY INSTRUCTIONS

THIS PENDANT LAMP HAS A POLARIZED PLUG (ONE BLADE IS WIDER THAN THE OTHER) AS A SAFETY FEATURE TO REDUCE THE RISK OF ELECTRIC SHOCK. THIS PLUG WILL FIT IN A POLARIZED OUTLET ONLY ONE WAY. IF THE PLUG DOES NOT FIT FULLY IN THE OUTLET, REVERSE THE PLUG. IF IT STILL DOES NOT FIT, CONTACT A QUALIFIED ELECTRICIAN. NEVER USE WITH AN EXTENSION CORD UNLESS PLUG CAN BE FULLY INSERTED. DO NOT ALTER THE PLUG.

This page lists all the contents included in the box. Please take the time to identify the hardware as well as the individual components to this product. As you unpack and prepare for assembly, place the contents on a carpeted or padded area to protect them from damage.

1 Hook on all Crystal Panel (B) to Lamp Body (A).

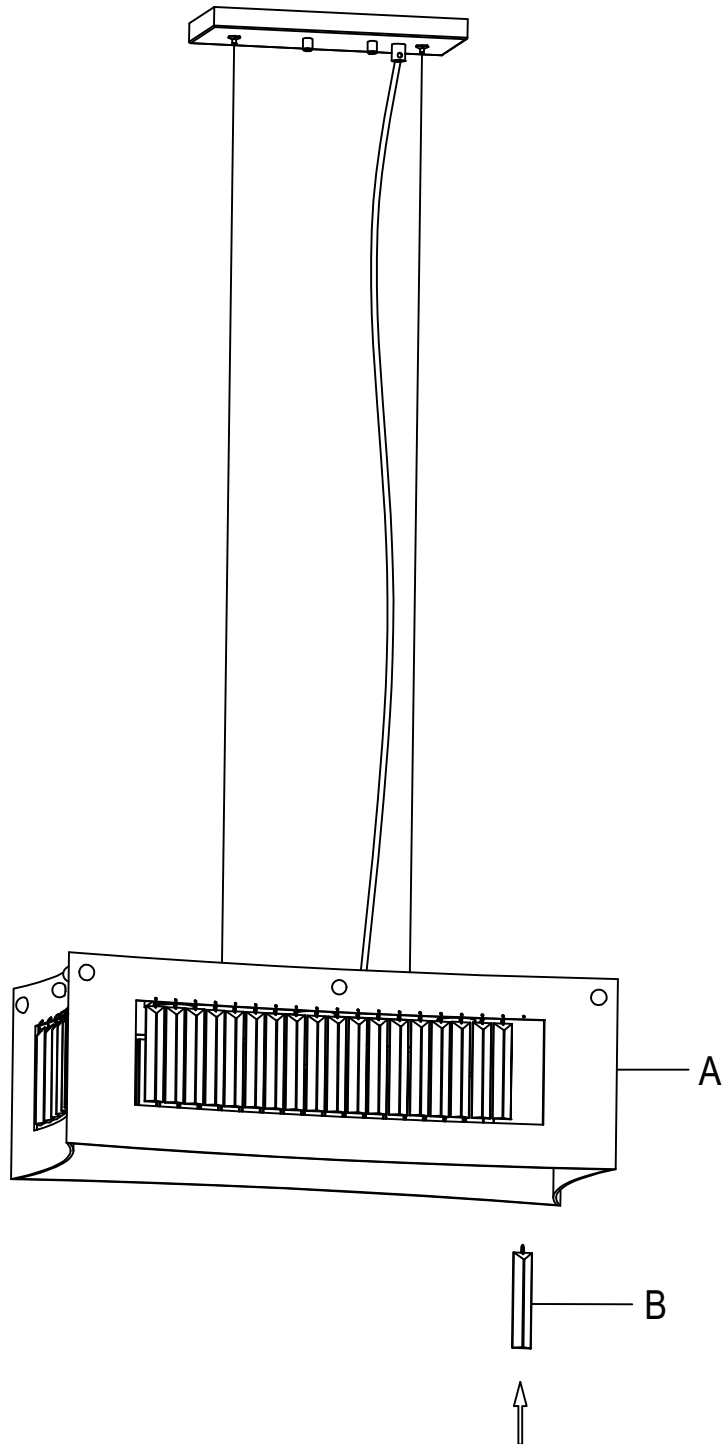

2 Firstly, remove Accessory (C) from the ceiling base of Lamp Body (A), take out the bracket. Secondly, connect the Wire Connector (F) & Wire Connector (G) together with cable and then fix the bracket on the ceiling using Bolt (E) and Flat Washer (D) by screwdriver. Finally, put the ceiling base back to cover the bracket using Accessory (C) to fix them.

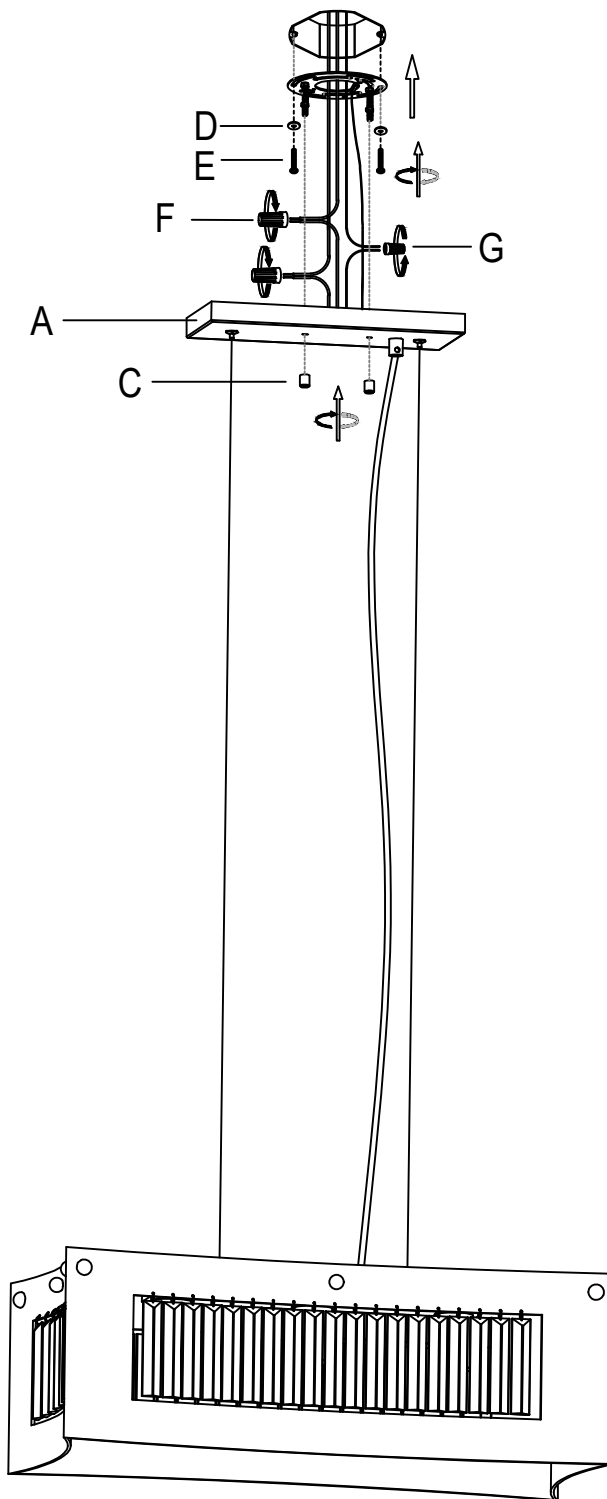

Cleaning & Care

Treat surface with care. Surface is resistant to scratches but is not scratch resistant. Clean surfaces with a dry or damp soft cloth. Do not use abrasive cleaners. Hardware may loosen over time. Periodically check that all connections are tight.