

ASSEMBLY INSTRUCTION

METAL ROUND BOOKCASE

A Front Frame - Top **B** Front Frame - Bottom **C** Back Frame - Top **D** Back Frame - Bottom



1pc

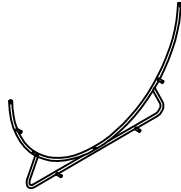

1pc



1pc

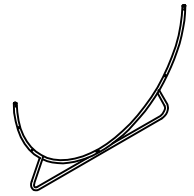

1pc

E Middle Frame



1pc

F Connect Bar

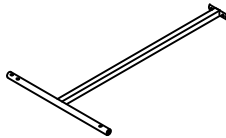

1pc

G Connect Bar

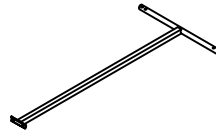

1pc

H Connect Bar

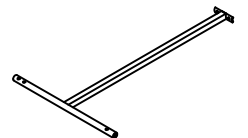

1pc

I Connect Bar

J Connect Bar

K Connect Bar

L Connect Bar

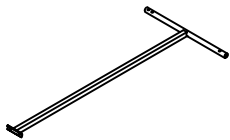

1pc

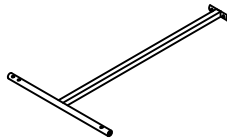

1pc

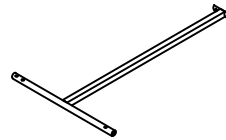

1pc

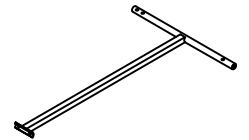

1pc

M Cross Bar

N Shelf Board

O Shelf Board

P Shelf Board



2pcs

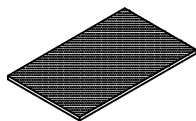

1pc

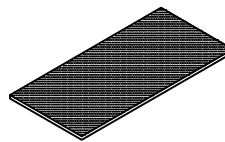

2pcs

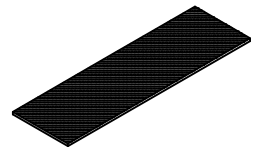

1pc

Q Shelf Board

R Bolt
Ø1/4"x1/2"

S Bolt
Ø1/4"x1-1/2"

T Bolt
Ø1/4"x2-1/4"

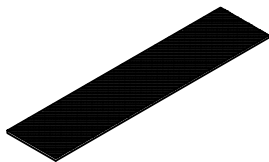

1pc

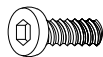

4pcs



9pcs



2pcs

U Bolt
Ø1/4"x1-1/2"

V Bolt
Ø3/16"x3/8"

W Screw
M4x28mm

X Allen Key
M4



2pcs

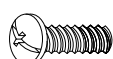

23pcs

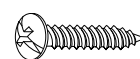

24pcs



1pc

Y Anti-Tipping Kit

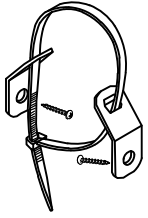

1set

Z Screwdriver
(Not Provided)

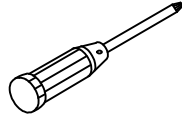

1pc

AA Flat Washer
Ø12mm



2pcs

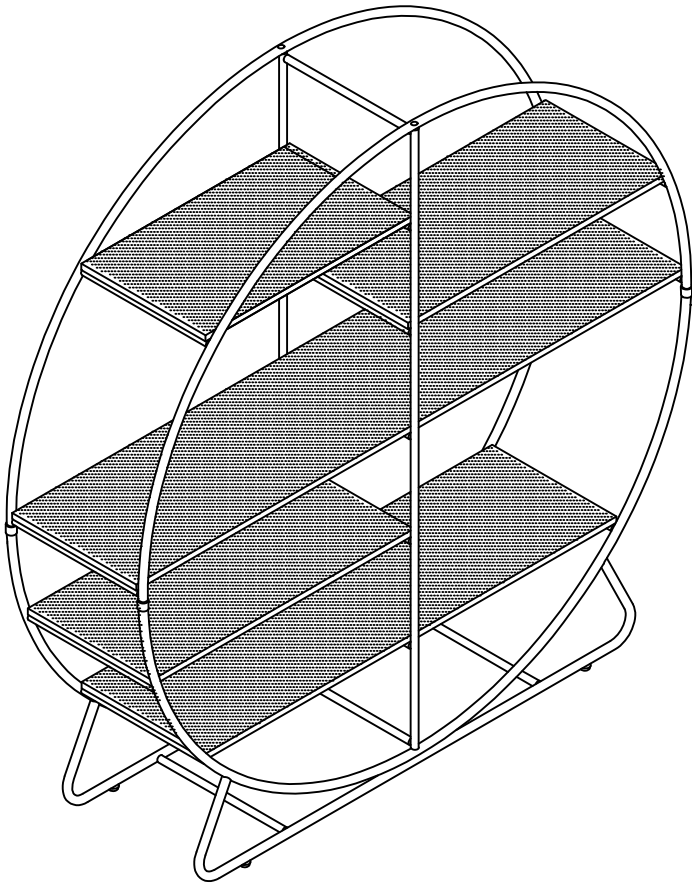

This page lists all the contents included in the box. Please take the time to identify the hardware as well as the individual components to this product. As you unpack and prepare for assembly, place the contents on a carpeted or padded area to protect them from damage.

1 Assemble Front Frame - Top (A) to the Front Frame - Bottom (B) with Bolt (R), then fasten by Allen Key (X). **Please ensure part A & B Green Label are assembled together !**

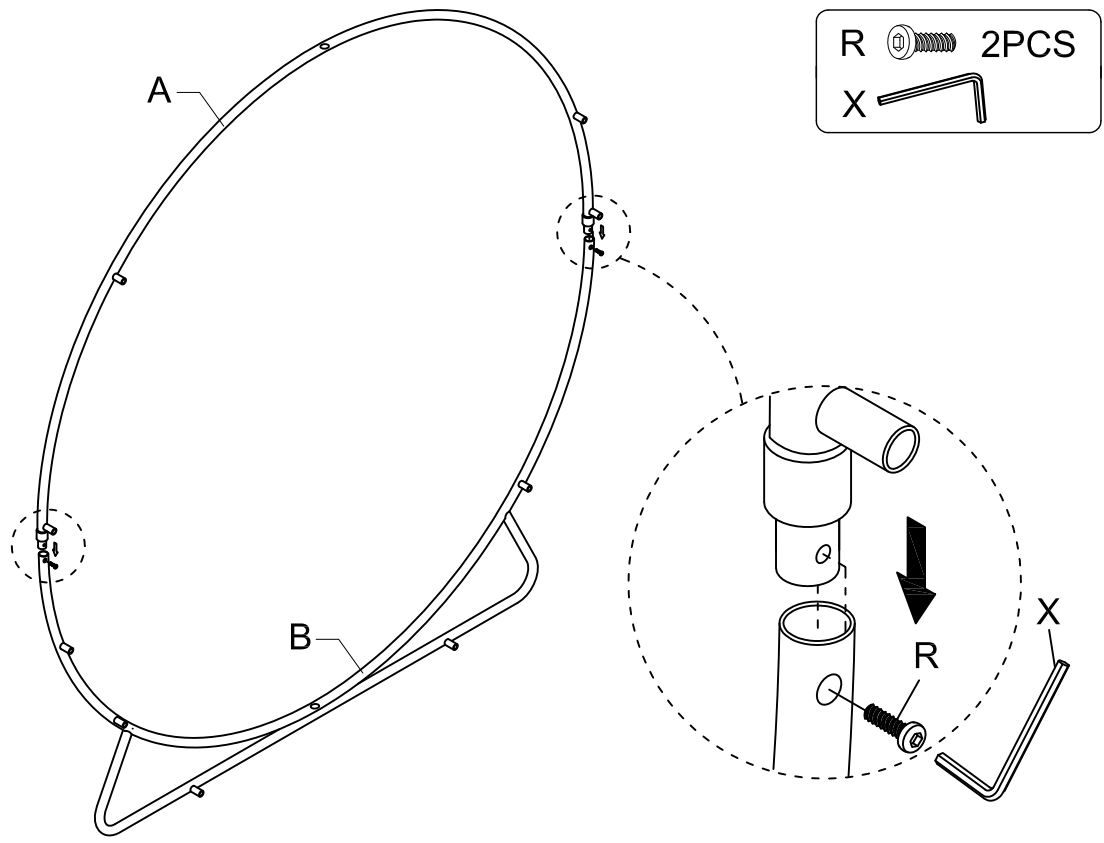

2 Assemble Back Frame - Top (C) to the Back Frame - Bottom (D) with Bolt (R), then fasten by Allen Key (X).

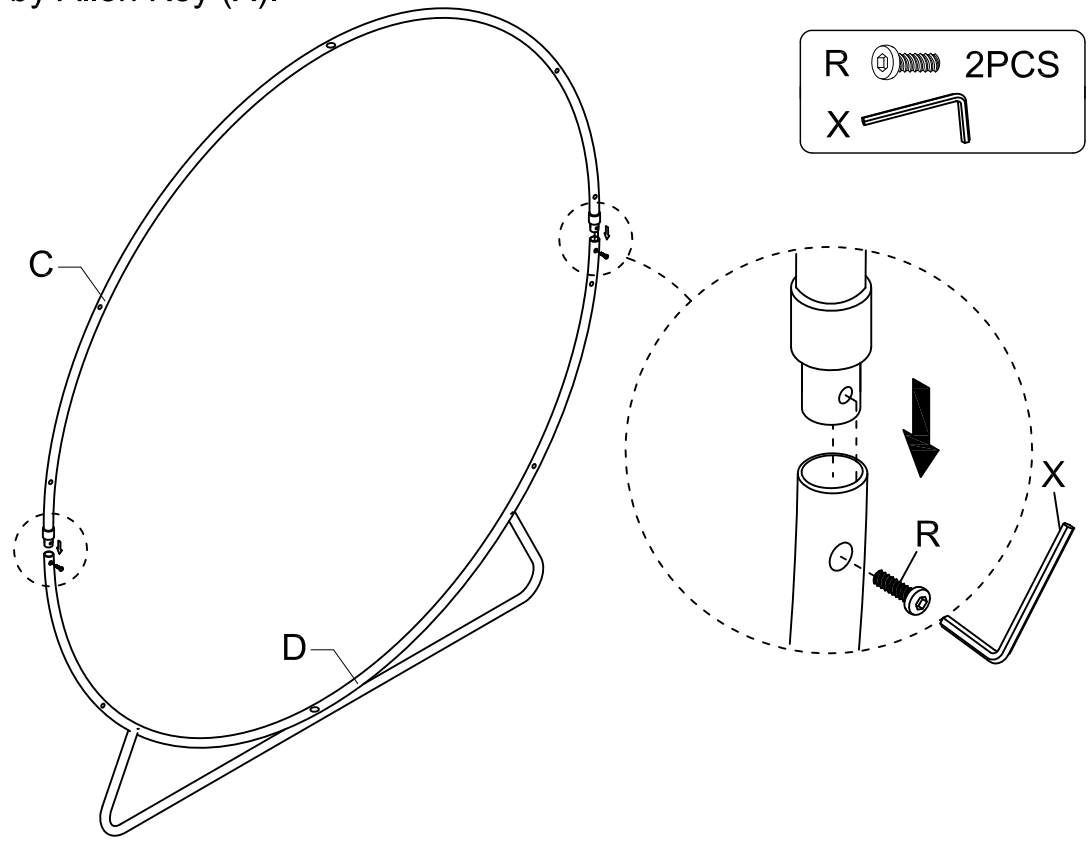

- 3** Assemble Connect Bar (F), Connect Bar (G), Connect Bar (H), Connect Bar (I), Connect Bar (J), Connect Bar (K), Connect Bar (L) to the Front Frame - Top (A), Front Frame - Bottom (B) and Middle Frame (E) with Bolt (V) by Screwdriver (Z). Next, assemble Cross Bar (M) to Front Frame - Bottom (B) with Bolt (V) & Flat Washer (AA) by Screwdriver (Z).

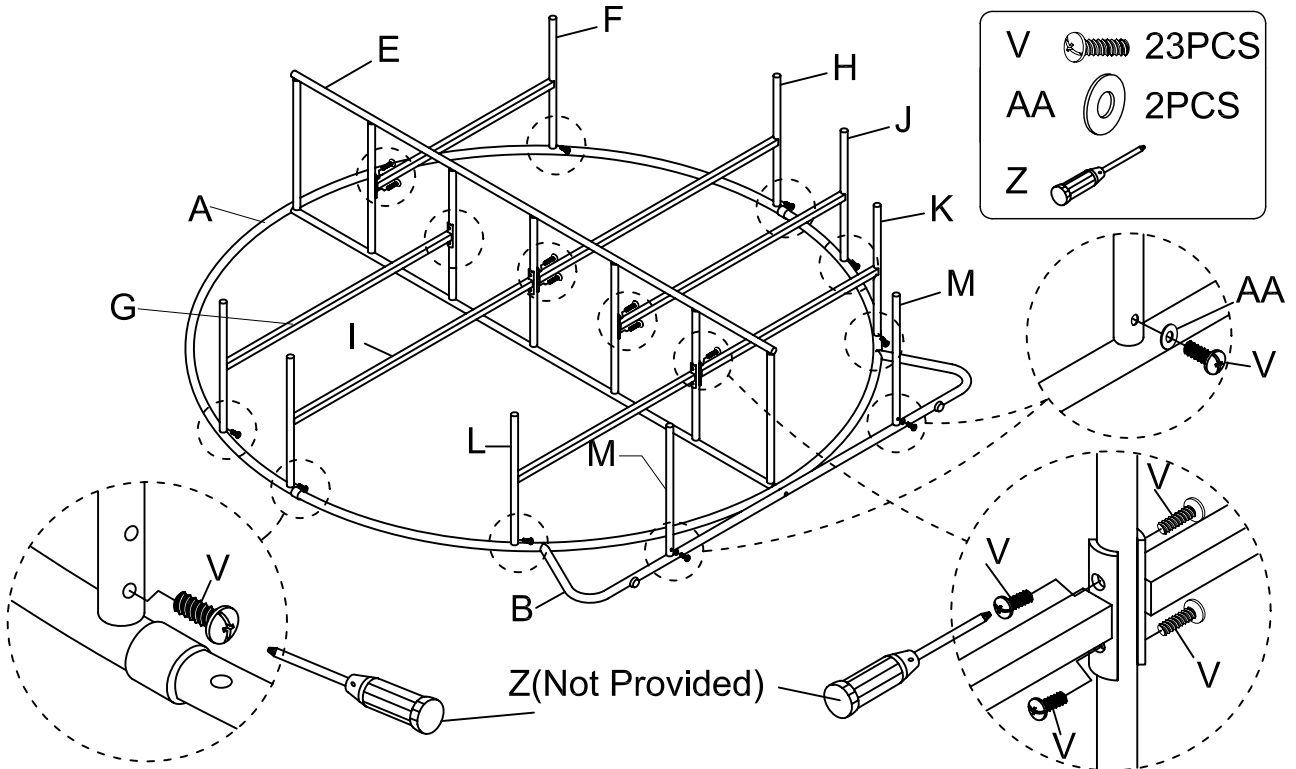

- 4** Assemble Back Frame - Top (C), Back Frame - Bottom (D) to all assembled bass with Bolt (S) by Allen Key (X). Then assemble the Middle Frame (E) to Front Frame - Top (A), Front Frame - Bottom (B), Back Frame - Top (C) & Back Frame - Bottom (D), using Bolt (U) & Bolt (T) with Allen Key (X).

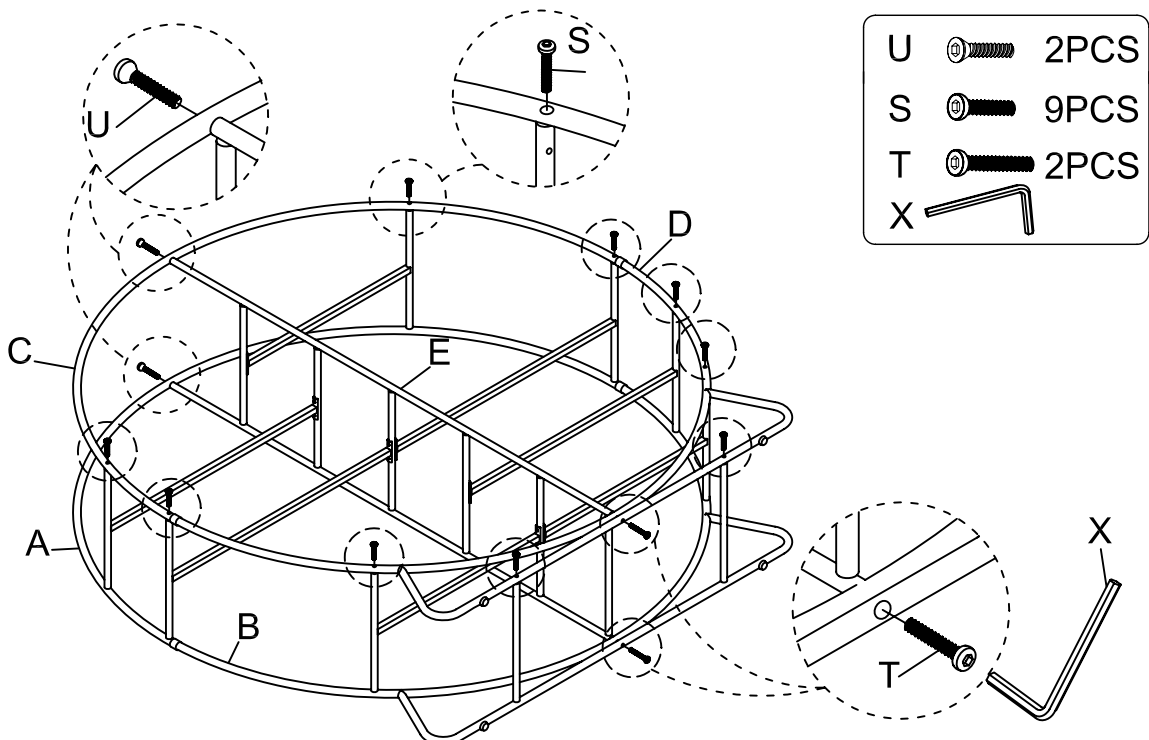

5 Assemble Shelf Board (N) to Connect Bar (F) & Middle Frame (E), Shelf Board (O) to Connect Bar (G), Connect Bar (J) & Middle Frame (E), Shelf Board (P) to Connect Bar (L), Connect Bar (K) & Middle Frame (E), Shelf Board (Q) to Connect Bar (I), Connect Bar (H) & Middle Frame (E), with Screw (W) by Screwdriver (Z).

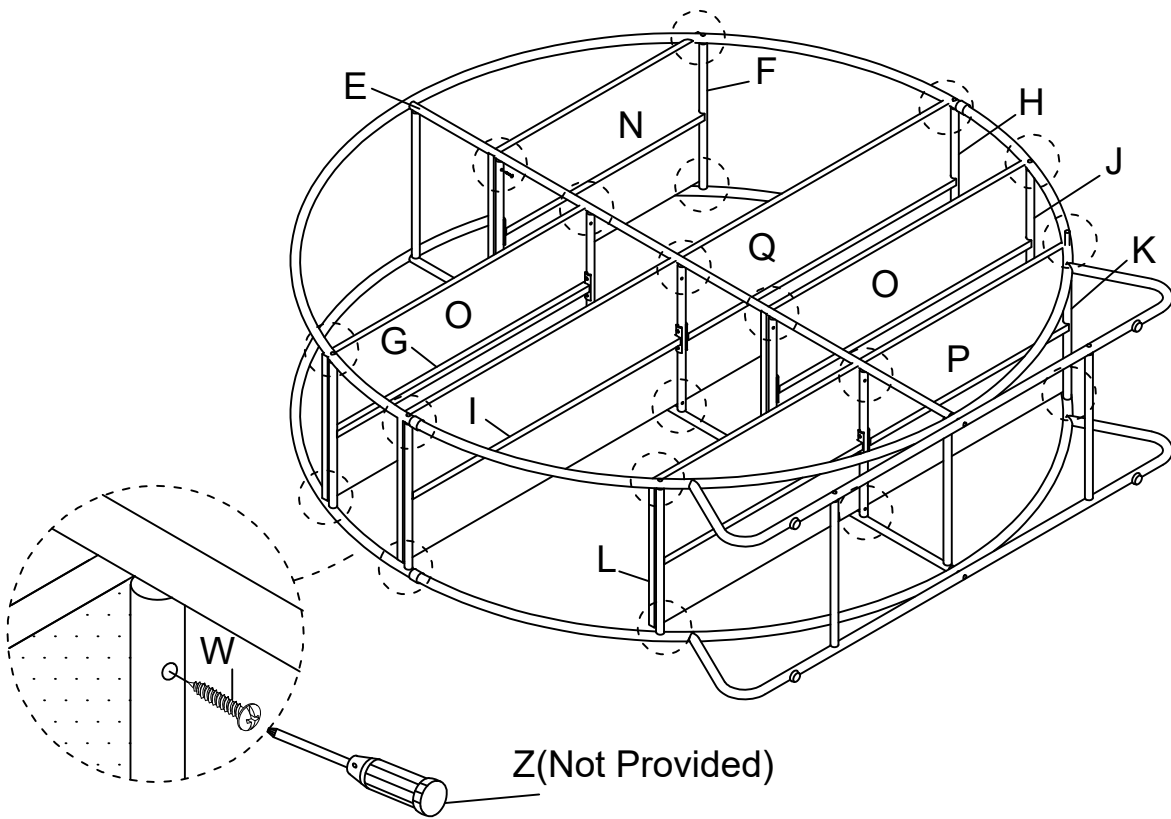
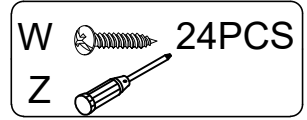

- 6** Remark: there is a tip restraint kit provided on the back of this product. Please read the instruction thoroughly and install immediately when placed in home. To prevent tip over, the product must be attached to wall.

Y  1PC

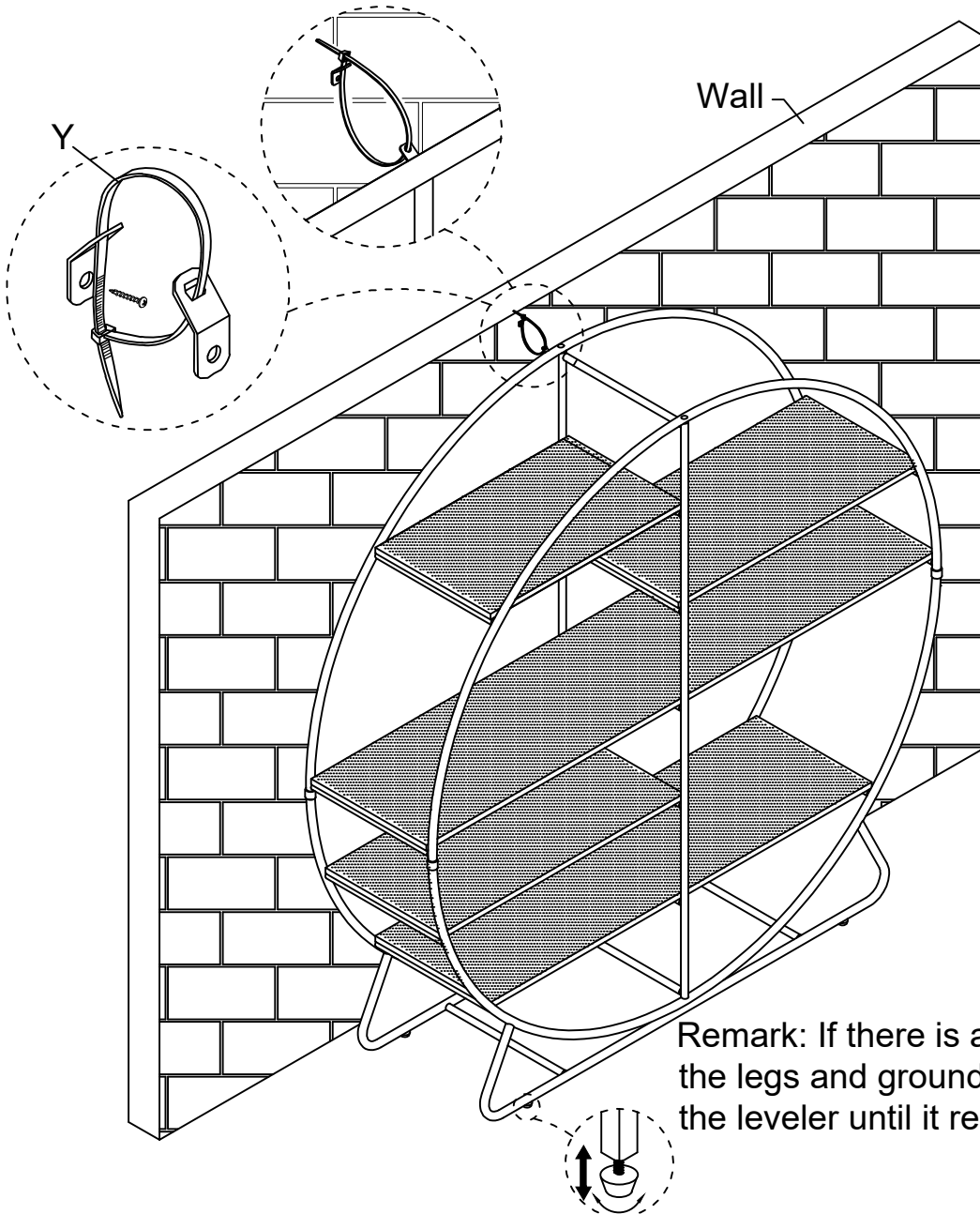

Adjust any parts out of alignment and tighten all bolts and screws from steps 1 through 6.

Cleaning & Care

Treat surface with care. Surface is resistant to scratches but is not scratch resistant. Clean surfaces with a dry or damp soft cloth. Do not use abrasive cleaners. Hardware may loosen over time. Periodically check that all connections are tight.