

KidKraft is here to help!

If you have any issues with your item or need any assistance, please contact us.

Email us with the **item number**, description of the problem, **part number** and **batch code**.

(Your batch number is located on the bottom left of this sheet of paper.)

www.kidkraft.com/assembly-instructions

¡En KidKraft estamos para ayudarle!

Si tiene algún problema con su artículo o necesita ayuda, por favor contáctenos. Envíenos un **Email** con el **número del artículo**, descripción del problema, **número de la pieza** y **código de lote**.

(Su código de lote se localiza en la parte inferior izquierda de esta página.)

www.kidkraft.com/assembly-instructions

KidKraft est là pour vous aider!

Si vous avez un problème avec un article ou si vous avez besoin d'assistance, contactez-nous s'il vous plait.

Envoyez-nous un **e-mail** précisant le **numéro de référence**, la description du problème, le **numéro de référence** de la pièce et le **code de lot**.

(Votre la pièce et le code de lot est situé en bas à gauche de cette feuille.)

www.kidkraft.com/assembly-instructions

KidKraft hilft Ihnen gerne!

Sie können uns jederzeit kontaktieren, falls Sie Probleme mit Ihrem Artikel haben oder sonst Unterstützung benötigen. Senden Sie uns einfach eine **E-Mail** mit der **Artikelnummer**, eine Beschreibung des Problems sowie der **Teile-** und **Chargennummer**. (Sie finden Ihre Chargennummer unten links auf dieser Seite.)

www.kidkraft.com/assembly-instructions

KidKraft helpt u graag!

Neem alstublieft contact met ons op als u een probleem heeft met uw artikel of hulp nodig heeft. **Email** ons het **artikelnummer**, een omschrijving van het probleem, het **onderdeelnummer** en de **partij-code**.

(De partij-code vindt u onderaan links op deze pagina.)

www.kidkraft.com/assembly-instructions



**Batch Code / Código De Lote /
La Pièce Et Le Code De Lot /
Chargennummer / Partij-code:**





Contact Us! / ¡Contáctanos! / Nous Contacter! / Kontaktieren Sie Uns! / Contacteer Ons!

U.S. / MEXICO

KidKraft
4630 Olin Road
Dallas, Texas 75244
www.kidkraft.com
customerservice@kidkraft.com
1.800.933.0771
972.385.0100

**EUROPEAN REGIONS / REGIÓN DE EUROPA / RÉGION EUROPE /
EUROPAISCHE LANDSTRICHE / REGIO EUROPA**

KidKraft Netherlands BV
Olympisch Stadion 29
1076DE Amsterdam
The Netherlands
www.kidkraft.com
europcustomerservice@kidkraft.com
+31 (0)20 305 8620

CANADA

KidKraft
4630 Olin Road
Dallas, Texas 75244
www.kidkraft.com
canadacustomerservice@kidkraft.com
1.800.933.0771
972.385.0100

AUSTRALIA

KidKraft
Suite 7101,
2 Locomotive Street
Australian Technology Park
Eveleigh, NSW 2015
www.kidkraft.com.au
aucustomerservice@kidkraft.com

.....

ALL OTHER REGIONS / TOUTES LES AUTRES RÉGIONS









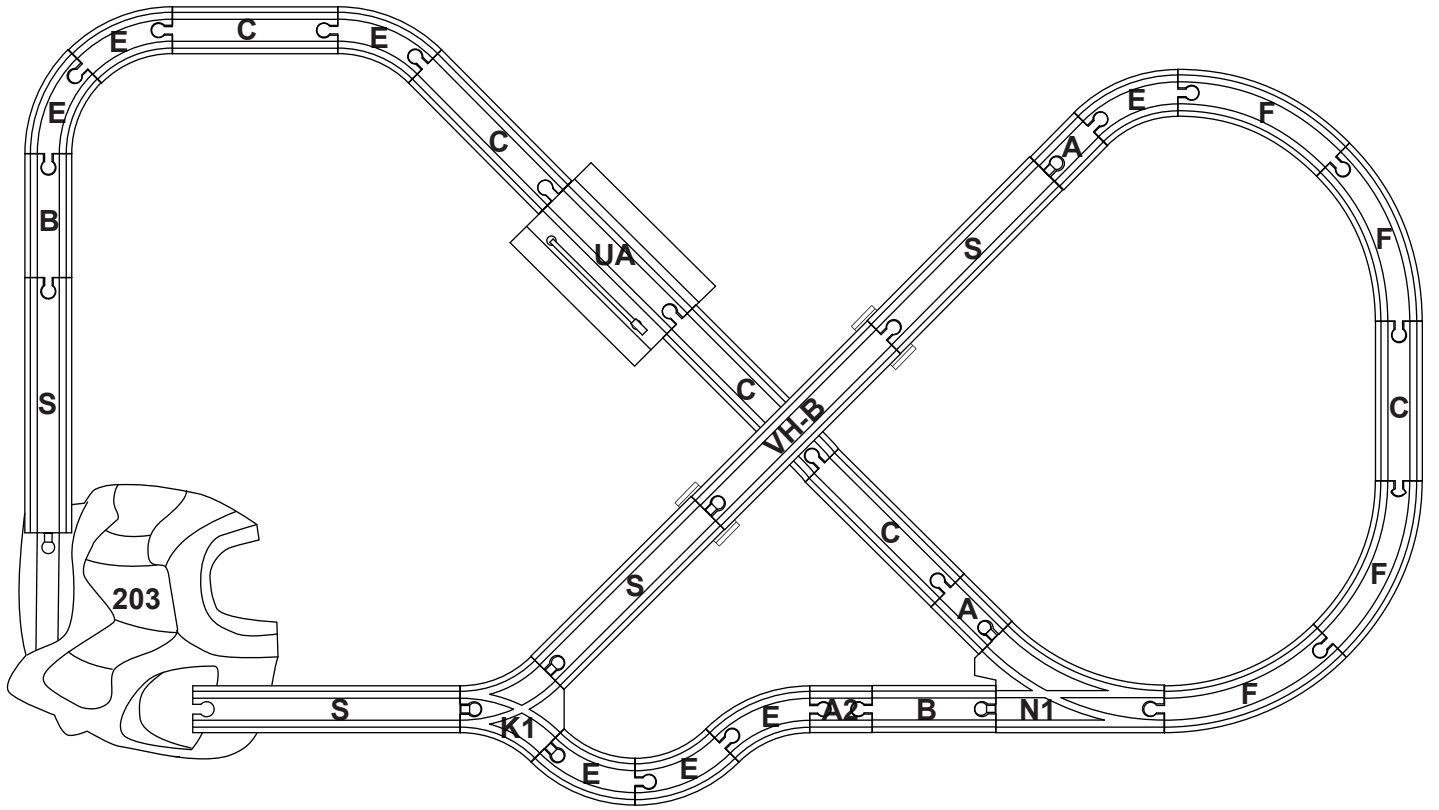

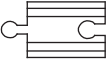

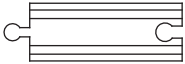
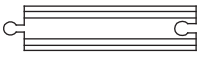
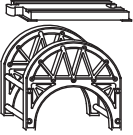

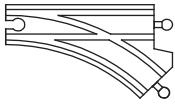
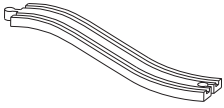
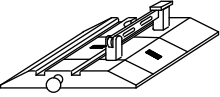

info@kidkraft.com

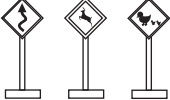

Item Number
Número del artículo
Description d'un article
Artikelnummern
Artikelnummers

17827

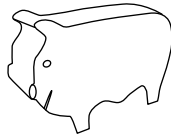
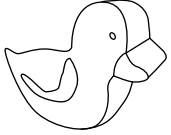
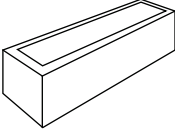
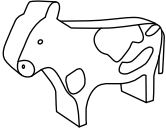
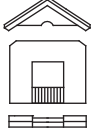

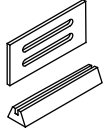
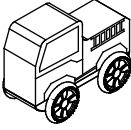
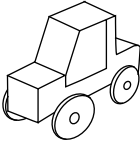
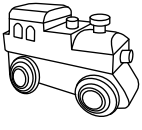
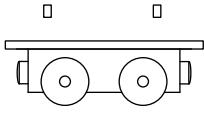
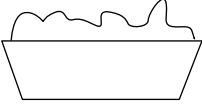
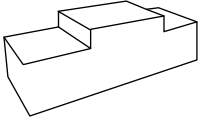
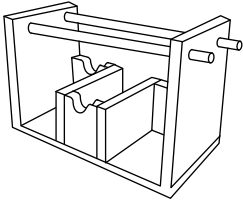
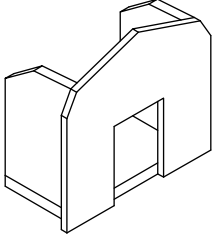
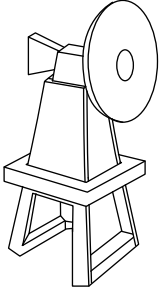
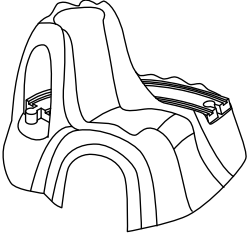
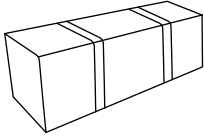
A	A2	B	C	VH- B
 x 2	 x 1	 x 2	 x 5	 x 1
E	F	K1	N1	S
 x 7	 x 4	 x 1	 x 1	 x 4
UA	201	140 A, B, C	210	101E, I, H
 x 1	 x 1	 x 1 x 1 x 1 =3	 x 5	 x 1 x 1 x 1 =3
101A	250	251	252	253
 x 1	 x 2	 x 1	 x 1	 x 1
254	255	256	257	155, C1
 x 1	 x 1	 =3	 x 1	 x 2
543B	501B	705S	800	801
 x 1	 x 1	 x 1	 x 2	 x 1
803	805	200	202	203
 x 1	 x 1	 x 1	 x 1	 x 1
 x 2				

A **x 1**

15 mm

B **x 6**

21 mm

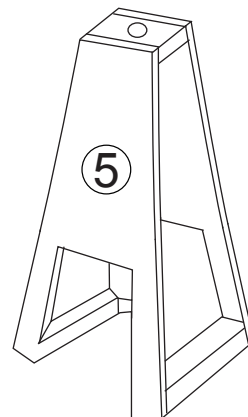
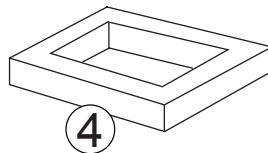
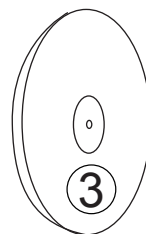
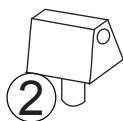
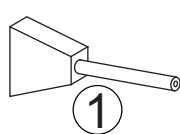

Step
Paso
Étape
Schritt
Stap

1

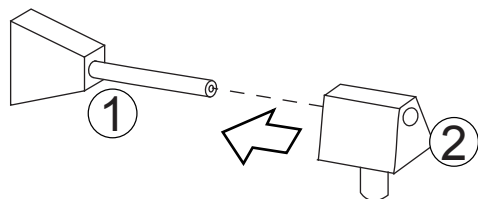

Step
Paso
Étape
Schritt
Stap

3

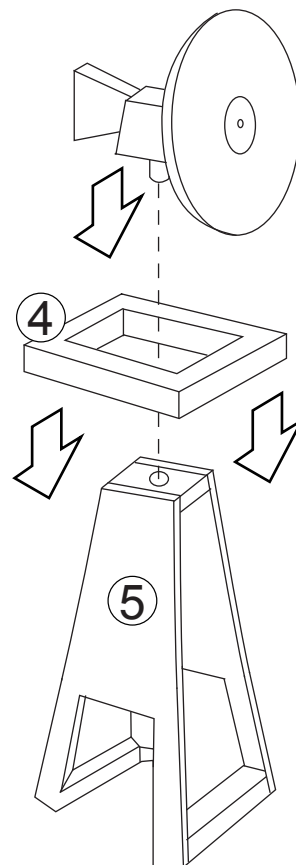

Step
Paso
Étape
Schritt
Stap

2

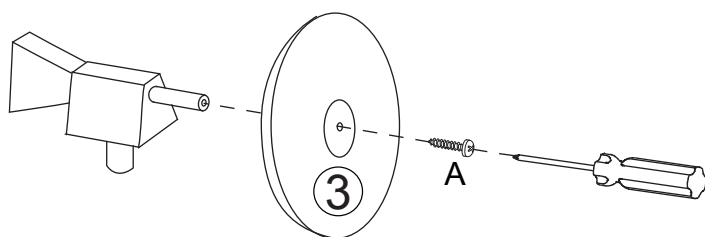

Parts and Hardware
Partes y Piezas Para Instalación
Pièces et Matériel
Teile und Befestigungsmaterial
Onderdelen en Schroeven en Gereedschap

All hardware dimensions are approximate.
Toutes les dimensions du matériel
sont approximatives.



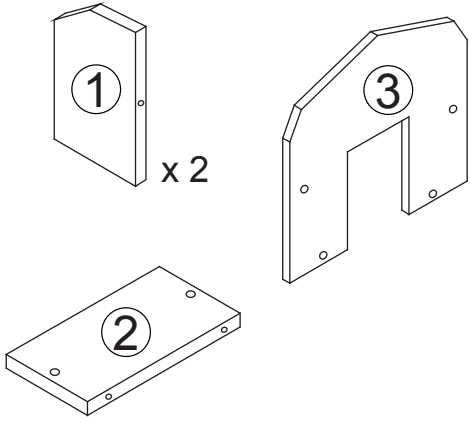

Step
Paso
Étape
Schritt
Stap

1

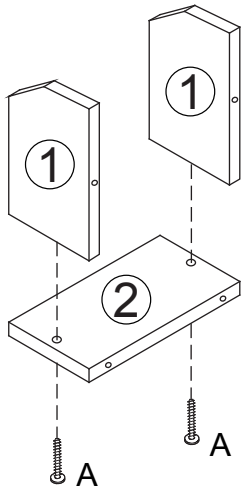

Step
Paso
Étape
Schritt
Stap

1

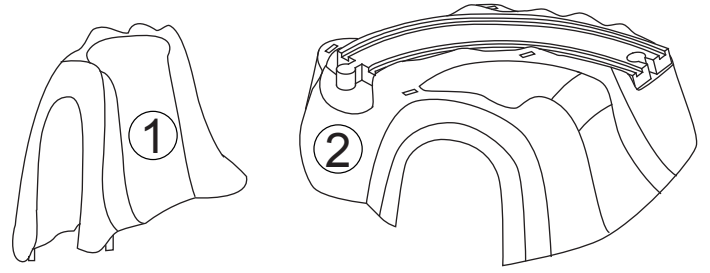

Step
Paso
Étape
Schritt
Stap

2

