

Optional Equipment Dimensions

- Whirlpool Pump: 12"(H) x 16"(L)
- Thermal Air Blower: 5"(H) x 11"(L)
- Hydro Fusion: 7"(H) x 15.5"(L)
- Hydro Indulge: 11"(H) x 19"(L)

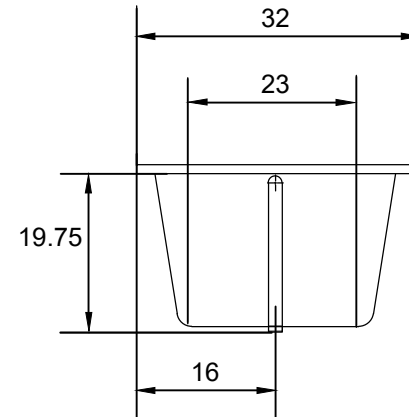
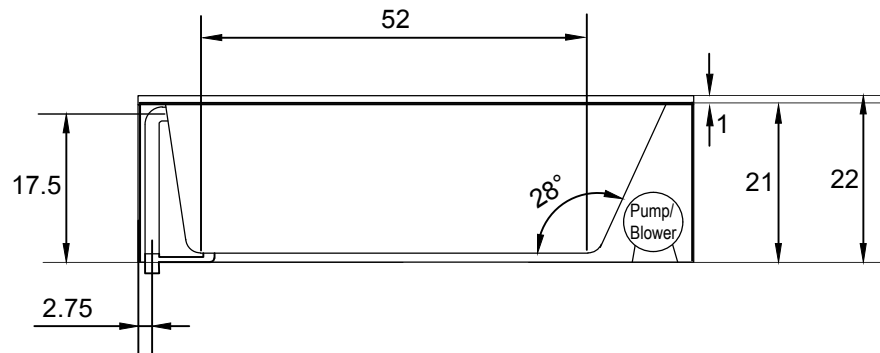

HYDRO SYSTEMS, INC.

29132 Avenue Paine, Valencia, CA 91355
661.775.0686, fax 661.775.0668, www.hydrossystem.com

Note: The information contained on this drawing is the sole property of Hydro Systems, Inc. Any reproduction in part or as a whole without the written permission of Hydro Systems, Inc. is prohibited.

Title: **SYDNEY 7232**

Date: July 11, 2018

Rev: V-1

Scale: None

Date:

Material: Acrylic and Fiberglass, 1/4" nominal thickness