

2025
Owner's Manual



Members of the ATA

800 - 694 - 9494

www.BearArchery.com

Table of Contents

Important Bow Information.....	1-3
Archery Safety & Warnings.....	4-5
Bow Diagrams.....	6-8
Care & Maintenance.....	9
Bow Adjustments.....	10
EKO Cam Adjustments.....	11-14
• Persist 33 & Persist	
• Execute 30 & 32	
• Whitetail Maxx	
• Whitetail INT	
• Refine	
• Redemption	
• Escalate	
• Whitetail PRO	
Hybrid Cam Adjustments.....	15-22
• Alaskan XT	
• Surpass	
• Game Keeper	
• Paradigm	
• Legend XR & 30	
• Resurgence	
• Alaskan	
Dual Cam Adjustments.....	23-25
• Legit	
• Cruzor G2 & G3 & G4	
• Royale	
• Limitless	
• Gamer Keeper Jr	
Single Cam Adjustments.....	26-28
• THP - Adapt & "2"	
• Resurgence LD	
• Whitetail Legend	
• Species	
• Species XT	
• Species EV	
• Species LD	
• Prowess	
Initial Bow Setup.....	29-32
Arrow Selection Information.....	33
Warranties & Contact Information.....	34

Record Important Bow Information Here (Keep for Future Reference)

Model:

Cable Length:

Weight Range:

Purchased From:

Draw Length:

Date of Purchase:

String Length:

Serial Number:

Congratulations! Your new Bear Archery compound bow is the finest available. It has been engineered for accuracy, long life, and built with quality and pride. No other bow delivers a higher performance to value ratio than a Bear. We know how much you are going to enjoy your new bow. For this reason, we ask you to read the Care and Maintenance section carefully to learn how easy it is to maintain the quality, performance, and level of satisfaction you expect from a Bear Archery product. ENJOY YOUR NEW BOW!

IMPORTANT LIMB INFORMATION

Your new Bear Archery bow uses the latest technology in limb design. This creates a limb capable of storing optimal amounts of energy unlike any other bow in the industry. For that reason, the use of limb mounted accessories such as vibration dampeners must be restricted. These particular accessories **MUST NOT BE** mounted more than 2 inches from the limb pockets. Mounting limb accessories more than 2 inches away from the pockets, particularly clamping type accessories, can potentially damage the limbs and void the warranty. See the illustration below.

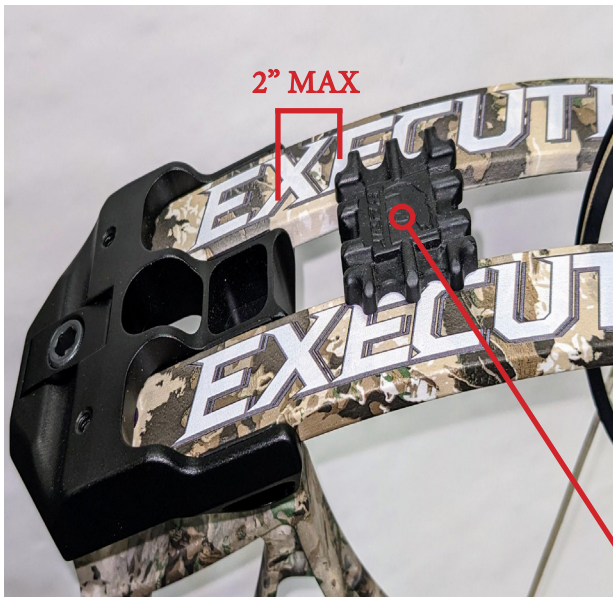

LIMB DAMPENER

IMPORTANT PRESS INFORMATION

Due to the design of your Bear Archery bow limbs, it is of the utmost importance that your bow **ONLY BE PRESSED IN PROPER BOW PRESSES**. Traditional style presses that use rollers to apply pressure only to the mid section of the limbs **CANNOT BE USED**. As illustrated below, only presses that are capable of applying pressure to the last 2" of the limbs should be utilized.

NOTE:

Limb bolts **MUST** be backed out 3 complete turns prior to pressing a bow equipped with flare quad limbs and 4 complete turns for bows equipped with max pre-load quad limbs.

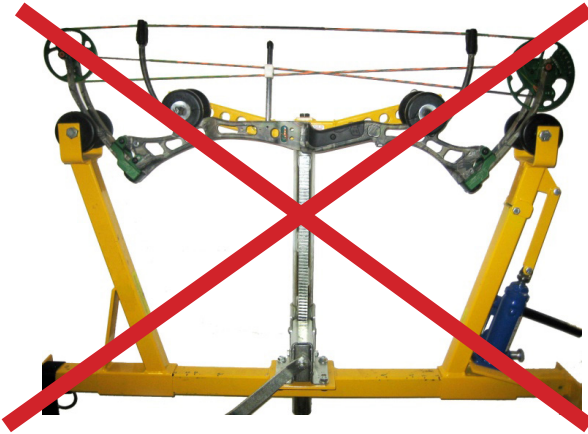

! DO NOT USE THIS STYLE BOW PRESS !

⚠ WARNING ⚠

Using the wrong bow press can result in immediate failure of the limbs, possible injury and void the manufacturer's warranty.

IMPORTANT PRESS INFORMATION

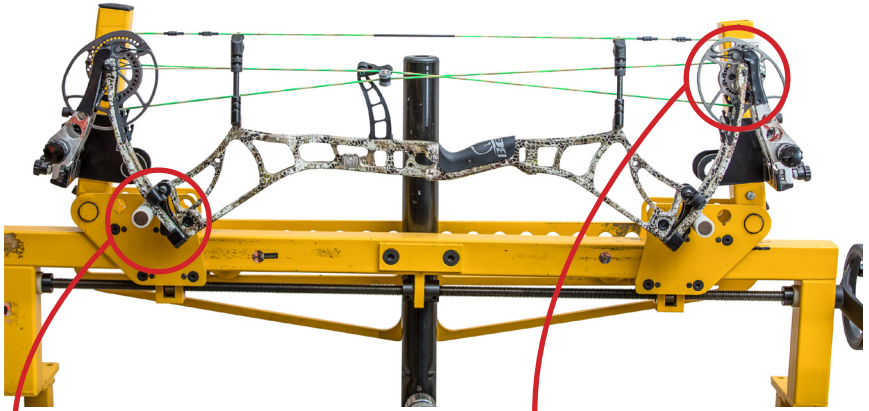

○ Certain bow models require the use of fixed stops to prevent the press forces from pushing the bow out of the bottom of the press.

○ Bow press MUST only be applied to the outer 2" of the limb tips.

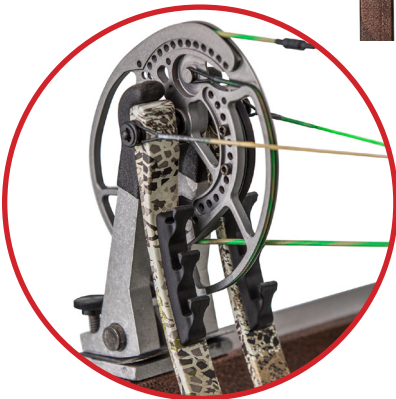

○ Press must ONLY apply pressure to the limbs in this area.

⚠ WARNING ⚠

! SAFETY FIRST !

⚠ WARNING ⚠

Before using this equipment, read and follow these manufacturer's instructions carefully. If you have any questions, contact the manufacturer or a qualified dealer.

Dry-firing a bow severely reduces the life expectancy of the bow and may cause immediate damage to the bow resulting in injury to yourself or others. Never dry fire your bow! If a bow is dry fired, it should be fully inspected by an authorized dealer before being shot again. **Please note damage due to dry fire is not covered under warranty.**

The use of safety glasses is recommended with any archery product.

Never pull back and release the bowstring without an arrow attached to the string. Your bow is designed to transfer energy to a properly weighted arrow.

Shooting underweight arrows has the same effect as dry-firing a bow and may cause serious injury. Use the proper arrow for you and your bow. If you are unsure about your arrow choice, contact your local Bear Archery dealer or an arrow manufacturer.

Do not use wooden or fiberglass arrows. They are not designed for use with this compound bow and may cause serious injury. Use the proper arrow for you and your bow. If you are unsure about your arrow choice, contact your archery dealer or an arrow manufacturer.

Inspect your arrows and nocks regularly. Immediately discard any dented, split, splintered or otherwise damaged arrows and replace cracked or broken nocks. A good test is to flex the arrows after each shot.

Do not draw your bow beyond its maximum draw length as damage to the limbs, cables and strings could occur.

Bear Archery compound bows are designed to be shot using a Mechanical Release Aid, Bear Archery does not recommend shooting with your fingers.

<h2>⚠ WARNING</h2>	
<ul style="list-style-type: none">• INGESTION HAZARD: This product contains a button cell or coin battery.• DEATH or serious injury can occur if ingested.• A swallowed button cell or coin battery can cause Internal Chemical Burns in as little as 2 hours.• KEEP new and used batteries OUT OF REACH of CHILDREN.• Seek immediate medical attention if a battery is suspected to be swallowed or inserted inside any part of the body.	
<ul style="list-style-type: none">a) Remove and immediately recycle or dispose of used batteries according to local regulations and keep away from children. Do NOT dispose of batteries in household trash or incinerate.b) Even used batteries may cause severe injury or death.c) Call a local poison control center for treatment information.d) Battery model: L736C or LR621e) Battery quantity: 3pcsf) Battery voltage: 1.5Vg) Non- rechargeable batteries are not to be recharged.h) Do not force discharge, recharge, disassemble, heat above (45°C) or incinerate. Doing so may result in injury due to venting, leakage or explosion resulting in chemical burns.i) Ensure the batteries are installed correctly according to polarity (+ and -).j) Do not mix old and new batteries, different brands or types of batteries, such as alkaline, carbon-zinc, or rechargeable batteries.k) Remove and immediately recycle or dispose of batteries from equipment not used for an extended period of time according to local regulations.l) Always completely secure the battery compartment. If the battery compartment does not close securely, stop using the product, remove the batteries, and keep them away from children.	

! SAFETY FIRST !

Targets and Hunting Safety

- Always wear safety glasses when handling or shooting your bow.
- Be sure of your target. Bow hunters often wear camouflage and are difficult to identify.
- Never aim at anything you don't intend to shoot.
- Never point or aim a drawn bow at another person.
- Never draw or shoot when anyone is between you and your target.
- Never shoot at a target or object unless you are sure that it can stop your arrows.
- Make sure the area behind and around your target is clear.
- Before shooting, be sure that no part of the bow will strike any tree branches or other obstacles.
- Never shoot arrows straight up in the air or in any direction where you might destroy property or endanger life.
- Always obey city and county ordinances.

Pre-shooting checklist
Are these items in good condition?
Properly installed? In working order?

___ Cables

___ Sight

___ String

___ Arrow Rest

___ String Serving

___ Arrow Nocks

___ Loop/Nock set

___ Arrow Shafts

___ Cable Slide

___ Set Screws

BOW DIAGRAMS

Understanding your bow and its component parts will add to your archery enjoyment. Although bows differ in performance and features, these photos represent the components available in various combinations on most models. Being familiar with this information will help you with the instructions throughout this manual. Also, you can refer to these photos when ordering parts or making technical inquiries.

BOW DIAGRAMS- SINGLE CAM BOW

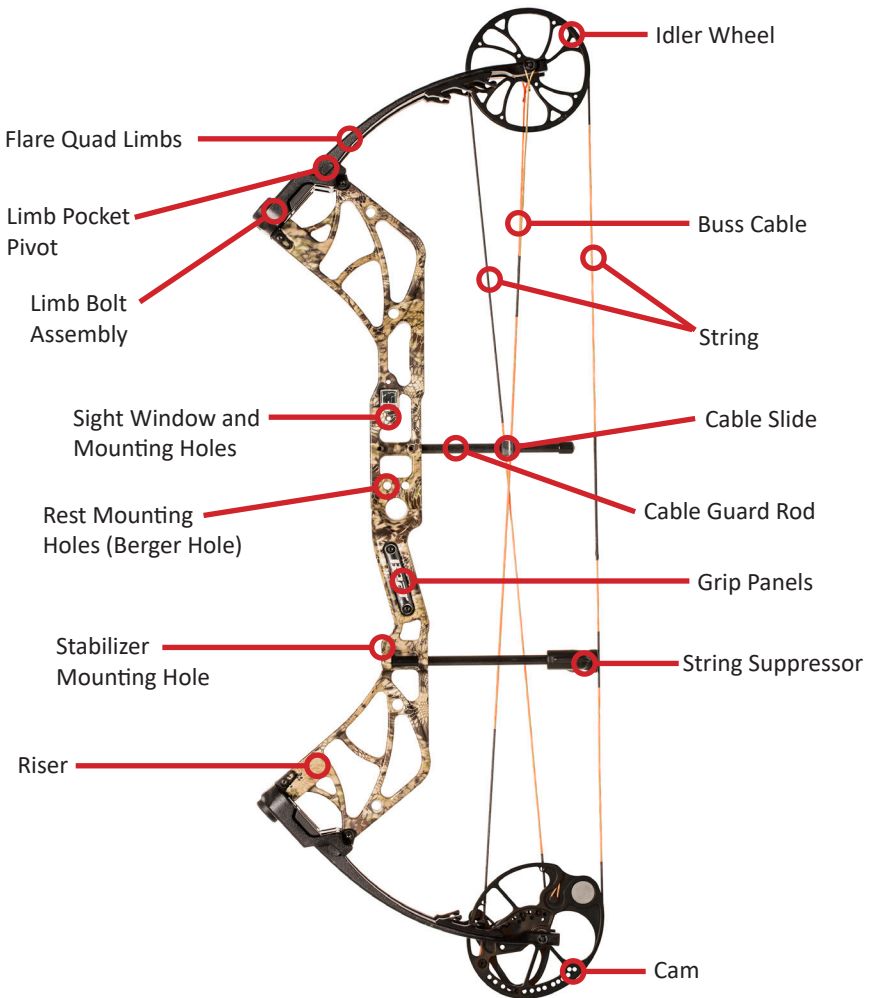

Bear Species Shown - Single Cam Bow

BOW DIAGRAMS- EKO CAM BOW

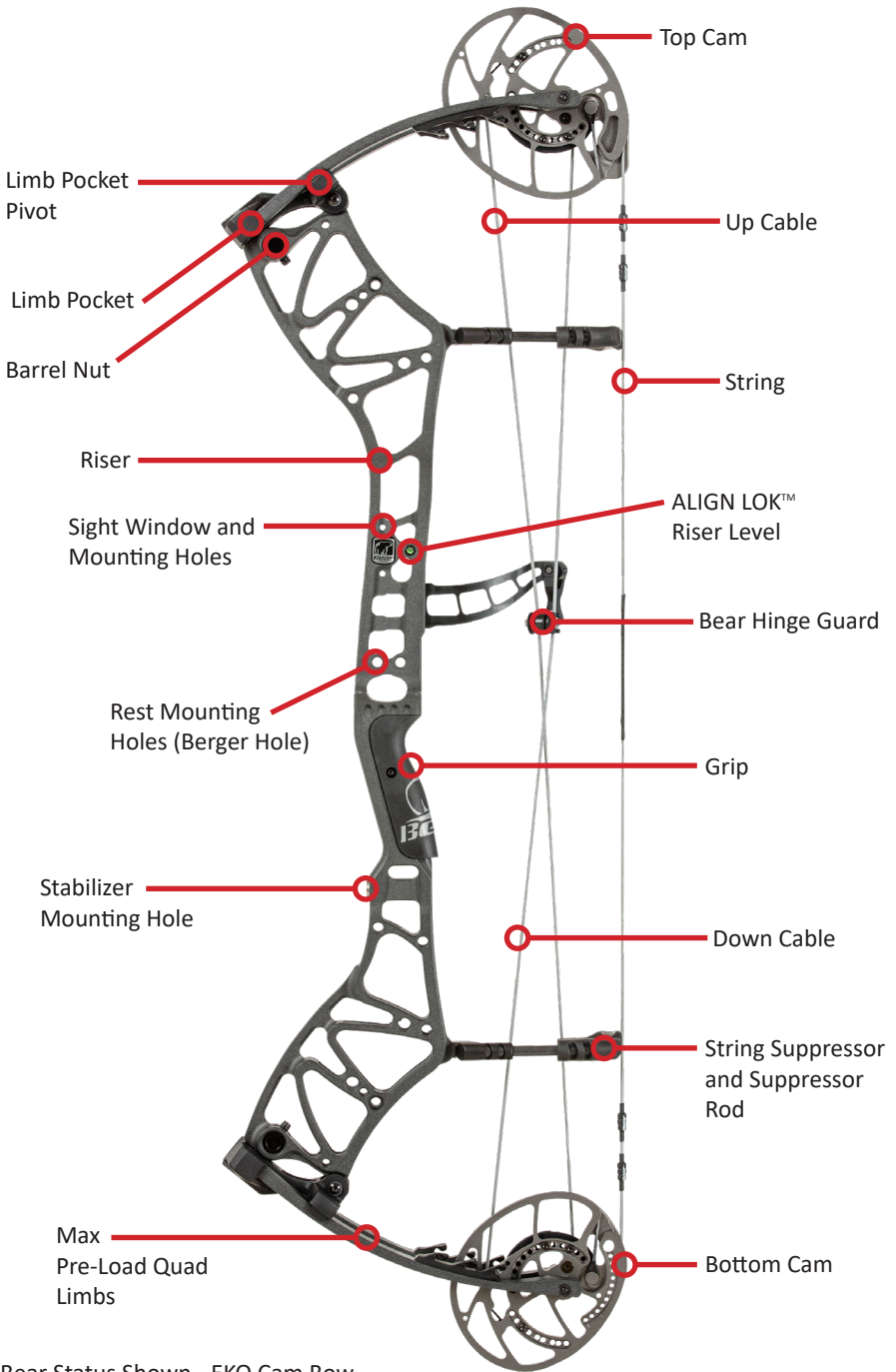

Bear Status Shown - EKO Cam Bow

BOW DIAGRAMS- HYBRID CAM BOW

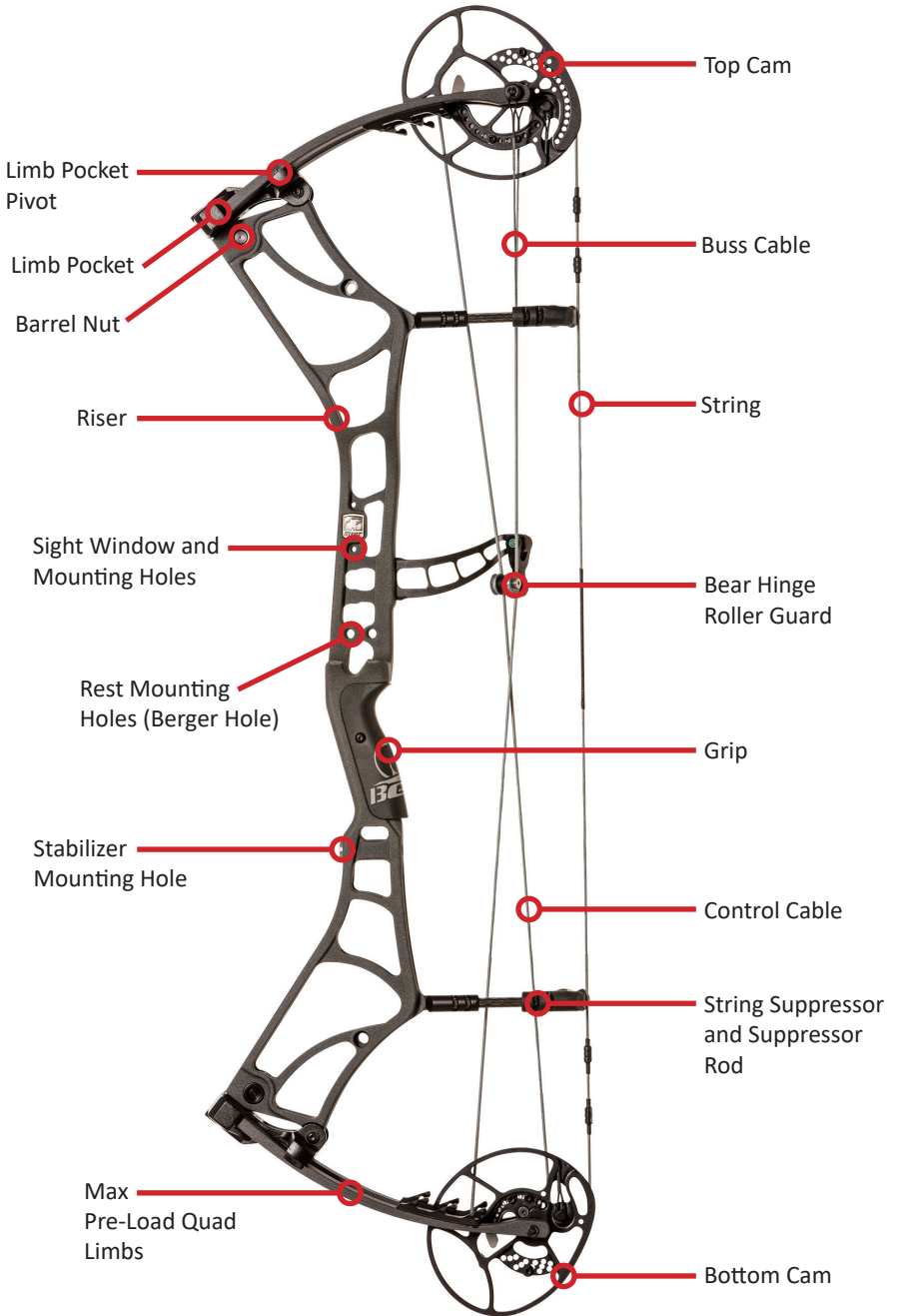

Bear Kuma LD Shown - Hybrid Cam Bow

CARE AND MAINTENANCE

With proper care and a minimum amount of routine maintenance, your bow will be kept in top condition. However, it is still important to carefully inspect your bow on a regular basis.

Cleaning

Your bow should be kept clean of dust, mud and grime. Use a damp soft cotton cloth to remove dirt and moisture. Do not use solvents such as acetone or mineral spirits as they may damage the finish.

Storage and Transportation

Avoid exposing your bow to temperatures over 125 degrees. Excessive heat may damage your bow. Do not leave your bow in your vehicle on a hot sunny day or store in a hot attic or other hot enclosed area. Clean your bow thoroughly after each use. Never put your bow away wet or store it in a damp place. Lightly oil all steel parts (axles, mounting screws) to prevent rust. You can relax the limbs if storing for more than a year. Follow the instructions under Peak Draw Weight Adjustment in the bow adjustment section.

Bow Presses

Use only APPROVED bow presses. Older style “single-pull” bow presses that contact the bow only in the grip area can result in bent or broken risers.

See page 2 & 3 and/or www.BearArchery.com for additional bow press information.

Lubrication

Your Bear Archery compound bow requires very little lubrication. Wipe the cable guard periodically with a dry cloth to keep the cable slide running smoothly and free of dust. Cam and idler wheel bearings do not require lubrication. If other lubrication is necessary, use white lithium grease or Teflon lubricants. Avoid excessive lubrication of any item, as this can attract dirt. On hunting bows, avoid lubricants with obvious odors.

String and Cable Maintenance

Regularly apply a high quality bowstring wax to your string and cable system. Regular waxing protects your cables and strings from abrasion, wear and separation. Smear the wax into position. Then, rub it gently with your fingers or a soft piece of leather to work the wax into the strands. Replace frayed or worn bowstrings and cables immediately.

Bear Archery strongly recommends replacing the bowstring and cable annually. Please visit your local Bear Archery dealer for assistance.

Counter-Clockwise
Decreases Peak Weight.

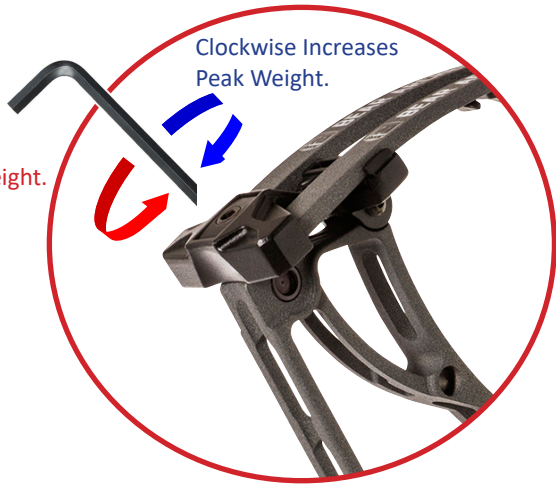

LIMB BOLT ADJUSTMENT "2025"		
BOW		MAX TURNS
Persist 33		6
Persist		6
Execute 30		6
Execute 32		6
Refine		6
Redemption		6
Whitetail INT		6
Whitetail Maxx		6
Whitetail Pro		6
Whitetail Legend		6
Legend 30		10
Legend XR		10
Alaskan XT		6
Alaskan		6
Gamekeeper		6
Surpass		6
Escalate		6
Paradigm		6
Resurgence		6
THP – Adapt 2 +		6
THP – Adapt		6
Resurgence LD		6
Species LD		6
Prowess		6
Species XT		6
Species EV		6
Species		6
Legit MAXX		10
Legit		10
Cruzer G4		10
Cruzer G3		12
Cruzer G2		12
Gamekeeper JR.		12
Royale		12
Limitless		4

CAM ADJUSTMENTS

- Adjusting Draw Length -
Synchronized EKO Cam Systems

⚠ WARNING ⚠

Failure to properly adjust the EKO cams to the specified settings may lead to the bow locking up, potentially causing severe bodily harm. DO NOT attempt to unlock with hands. In the event of a lock-up, contact BEAR directly or take the bow to a professional shop. Please exercise extreme caution.

The Synchronized EKO cam has a draw stop and rotating module for draw length adjustment. All draw length adjustments can be made without the use of a bow press. Draw length changes are made by simply moving the draw stop to the desired position, then rotating the modules accordingly. See draw length settings on the following page.

To change draw length, draw stops must be adjusted before the module. Remove the draw stop on both the top and bottom cam and remount it in the corresponding stop locations to the draw length and letoff percentage you selected. Not only is stop location crucial, but '+/-' orientation is important to determine letoff percentage. Next, remove the socket head cap screws from the top and bottom modules, rotate the modules to the desired positions (line up the indicator mark on the cam with the correct draw length indicator mark on the module), making sure to align the top and bottom to the same setting, and reapply the screws. Such module draw length adjustments will not affect peak draw weight or timing. Modules are right and left hand specific and top and bottom specific.

In order for the Synchronized EKO cam system to operate at maximum efficiency the timing needs to be set correctly. This means that the top and bottom cams roll over and hit their respective draw stops at the same time. The cam timing is set during assembly at the factory, but once the bow is broken in, or if you change strings/cables it is possible that the cam timing will need to be checked.

If the cam system is out of time and the top stop hits before the bottom stop, add twists into the up cable until both stops hit at the same time. If the cam system is out of time, and the bottom stop hits before the top stop, add twists to the down cable until both stops hit at the same time. The same affect could be achieved by taking twists out of the opposite cable in each scenario. The high quality string materials used on your Bear Bow will exhibit very little stretch and should maintain proper timing for extended periods under normal use. Bear Archery recommends checking the timing and tune of your bow after the first 250 shots. During this initial break in period, your strings are capable of minor stretching which may affect your tune.

CAM ADJUSTMENTS

- Adjusting Draw Length -
Synchronized EKO Cam Systems

DRAW LENGTH CHART - EKO CAMS "2025"

PERSIST 33	PERSIST 30	EXECUTE 30	EXECUTE 32	WHITTAIL INT	WHITTAIL MAXX	REFINE	REDEMPTION	ESCALATE	WHITTAIL PRO	LETOFF %	STOP LOCATION	STOP DIRECTION	MODULE SETTING
30.5	30	30	30.5	30	30	30.5	30	30	30	75	A	+	0
										80	A	-	0.25
										85	A	+	0.25
										90	A	-	0.5
30	29.5	29.5	30	29.5	29.5	30	29.5	29.5	29.5	75	B	+	0.5
										80	B	-	0.75
										85	B	+	0.75
										90	B	-	1
29.5	29	29	29.5	29	29	29.5	29	29	29	75	C	+	1.25
										80	C	-	1.5
										85	C	+	1.5
										90	C	-	1.75
29	28.5	28.5	29	28.5	28.5	29	28.5	28.5	28.5	75	D	+	2
										80	D	-	2.25
										85	D	+	2.25
										90	D	-	2.5
28.5	28	28	28.5	28	28	28.5	28	28	28	75	E	+	2.5
										80	E	-	2.75
										85	E	+	2.75
										90	E	-	3
28	27.5	27.5	28	27.5	27.5	28	27.5	27.5	27.5	75	F	-	3.25
										80	F	-	3.5
										85	F	+	3.5
										90	F	-	3.75
27.5	27	27	27.5	27	27	27.5	27	27	27	75	G	+	3.75
										80	G	-	4
										85	G	+	4
										90	G	+	4.25
27	26.5	26.5	27	26.5	26.5	27	26.5	26.5	26.5	75	H	-	4.5
										80	H	-	4.75
										85	H	+	4.75
										90	H	+	5
26.5	26	26	26.5	26	26	26.5	26	26	26	75	I	+	5
										80	I	-	5.25
										85	I	+	5.25
										90	I	+	5.5

CAM ADJUSTMENTS

Synchronized EKO Cam Systems

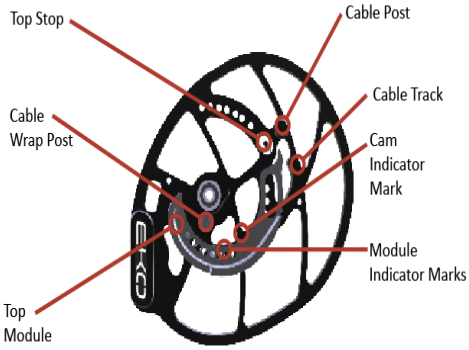

RH TOP CAM - Front View

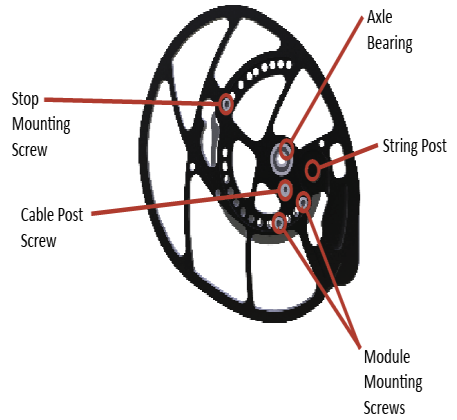

RH TOP CAM - Back View

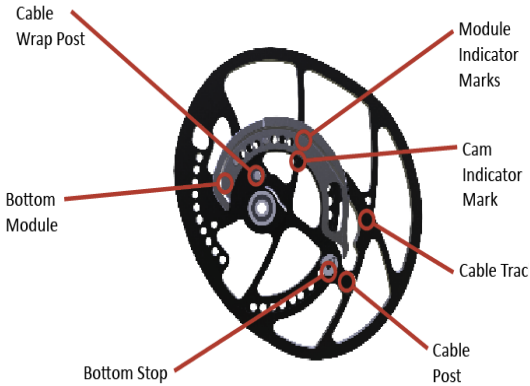

RH BOTTOM CAM - Front View

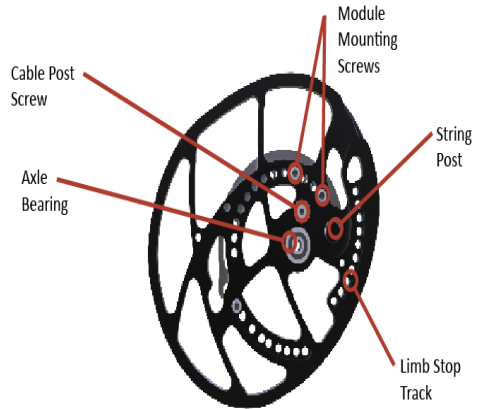

RH BOTTOM CAM - Back View

CAM ADJUSTMENTS

Synchronized EKO Cam Systems after "2024"

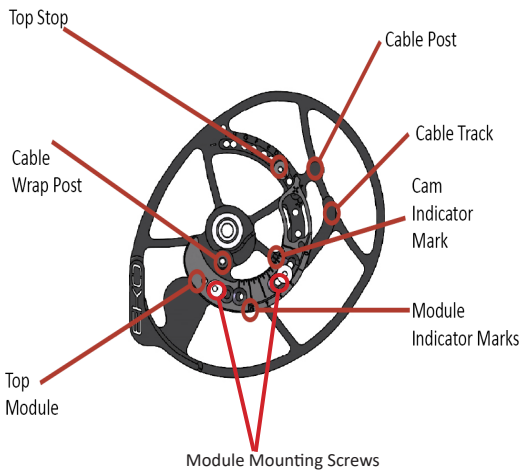

RH TOP CAM - Front View

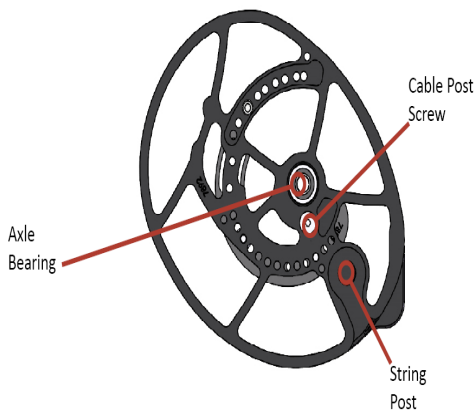

RH TOP CAM - Back View

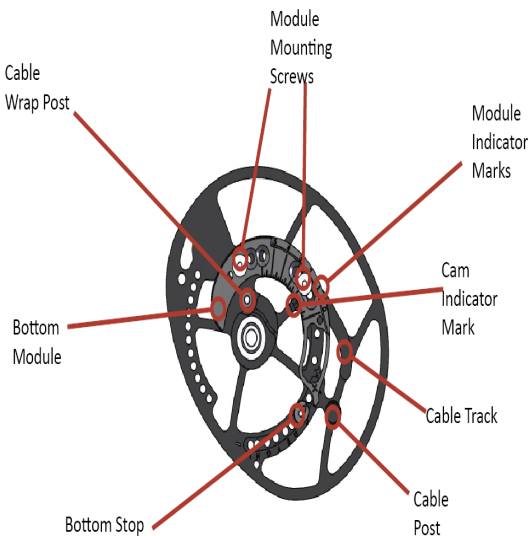

RH BOTTOM CAM - Front View

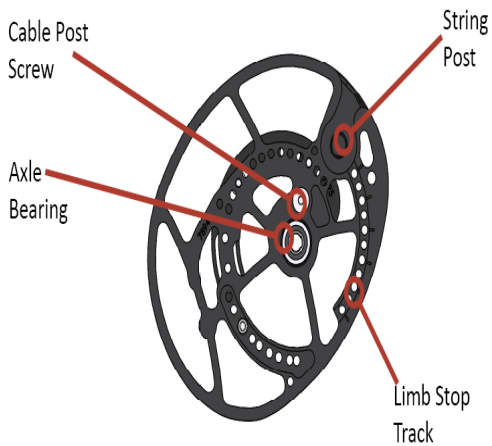

RH BOTTOM CAM - Back View

CAM ADJUSTMENTS
 - Adjusting Draw Length -
 HYBRID Cam Systems

DRAW LENGTH CHART - HYBRID CAMS		
MODULE SETTING	RESURGENCE	ALASKAN
3		
3.5		
4		
4.5	25.5	25.5
5	26	26
5.5	26.5	26.5
6	27	27
6.5	27.5	27.5
7	28	28
7.5	28.5	28.5
8	29	29
8.5	29.5	29.5
9	30	30
9.5	30.5	30.5
10	31	31
10.5		
11		

DRAW LENGTH CHART - HYBRID CAMS "2025"					
Draw Length Setting	Draw Stop Setting	ALASKAN XT	SURPASS	GAME KEEPER	PARADIGM
24	24				
24.5	24.5				
25	25	25	25		
25.5	25.5	25.5	25.5		
26	26	26	26		
26.5	26.5	26.5	26.5		
27	27	27	27	27	27
27.5	27.5	27.5	27.5	27.5	27.5
28	28	28	28	28	28
28.5	28.5	28.5	28.5	28.5	28.5
29	29	29	29	29	29
29.5	29.5	29.5	29.5	29.5	29.5
30	30	30	30	30	30
30.5	30.5			30.5	30.5
31	31			31	31
31.5	31.5			31.5	31.5
32	32			32	32

CAM ADJUSTMENTS

- Adjusting Draw Length - Synchronized Hybrid Cam Systems

The Synchronized Hybrid cam has a rotating module for draw length adjustment. All draw length adjustments can be made without the use of a bow press. Draw length changes are made by simply rotating the modules to the desired position and moving the draw stop. To change draw length, remove the screws from the top and bottom modules, rotate the modules to the desired positions (line up the indicator mark on the cam with the correct draw length indicator mark on the module), making sure to align the top and bottom to the same setting, and reapply the screws. Next, remove the draw stop on both the top and bottom cam and remount it in the corresponding stop locations to the draw length you selected. Such module draw length adjustments will not affect peak draw weight or timing. Modules are right and left hand specific and top and bottom specific.

In order for the Synchronized Hybrid cam system to operate at maximum efficiency the timing needs to be set correctly. This means that the top and bottom cams roll over and hit their respective draw stops at the same time. The cam timing is set during assembly at the factory, but once the bow is broken in, or if you change strings/cables it is possible that the cam timing will need to be checked.

If the cam system is out of time and the top stop hits before the bottom stop, add twists into the control cable until both stops hit at the same time. If the cam system is out of time, and the bottom stop hits before the top stop, take twists out of the control cable until both stops hit at the same time. The high quality string materials used on your Bear Bow will exhibit very little stretch and should maintain proper timing for extended periods under normal use. Bear Archery recommends checking the timing and tune of your bow after the first 250 shots. During this initial break in period, your strings are capable of minor stretching which may affect your tune.

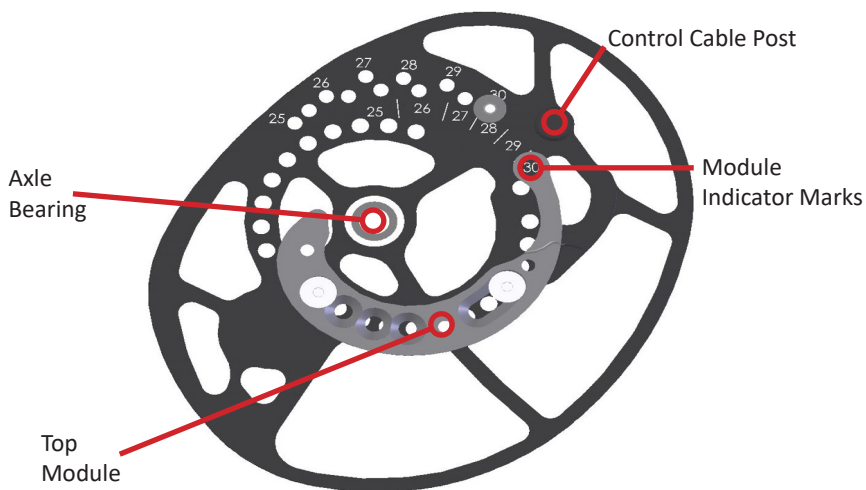

CAM ADJUSTMENTS

Synchronized Hybrid Cam Systems

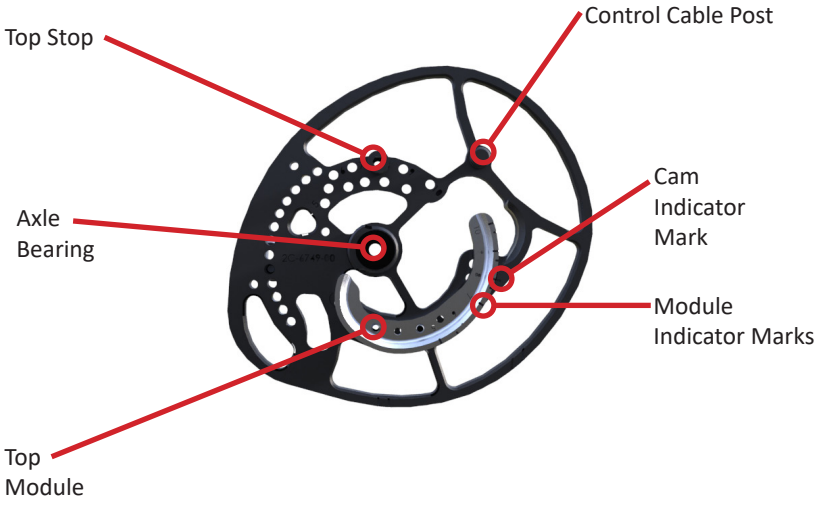

RH TOP CAM - Front View

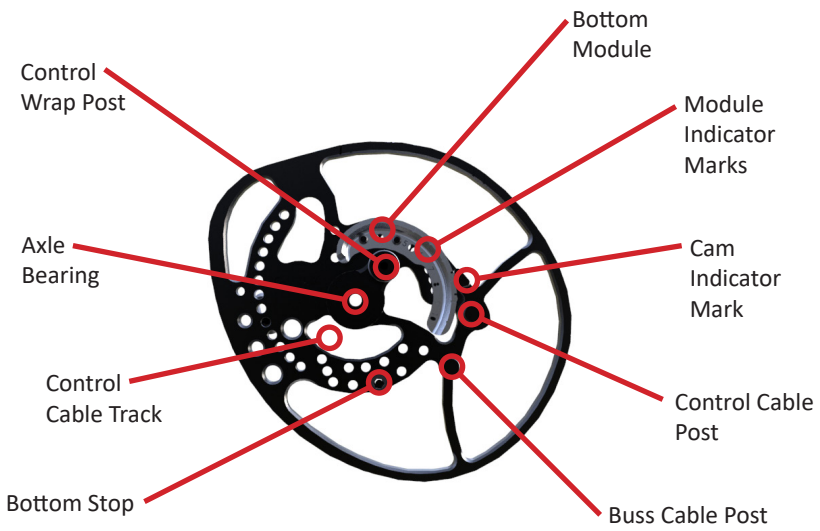

RH BOTTOM CAM - Front View

CAM ADJUSTMENTS

Synchronized Hybrid Cam Systems

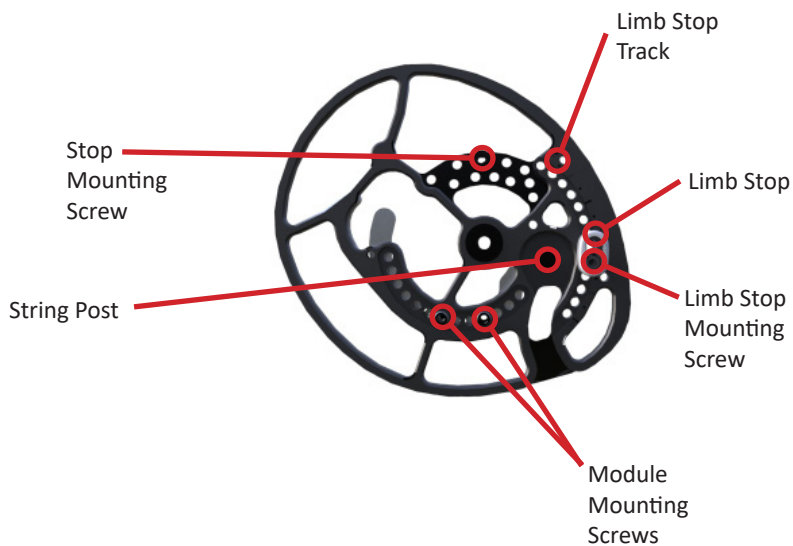

RH TOP CAM - Back View

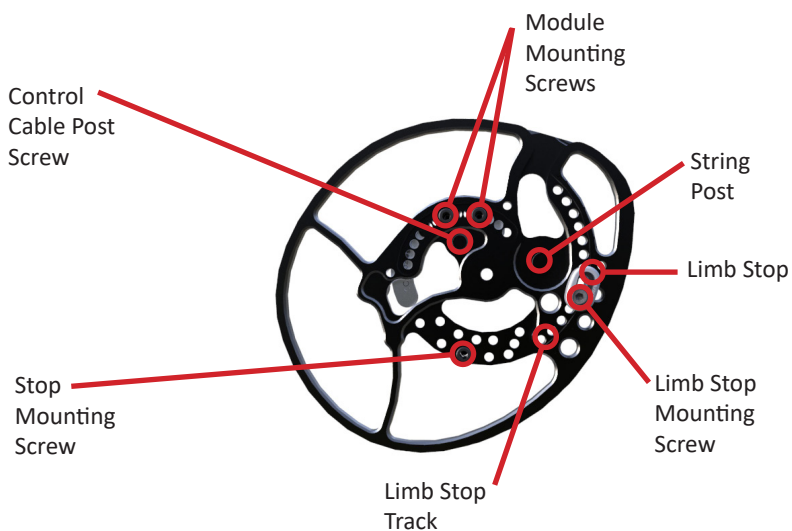

RH BOTTOM CAM - Back View

The DHC-XR cams have 3 different draw length ranges:

In RANGE “1”, the draw length will be 26.5-31 inches

In RANGE “2”, the draw length will be 22-26 inches

In RANGE “3”, the draw length will be 18-21.5 inches

1. Remove the bottom module from the cam.
2. Place the bow in a press and loosen the strings and cables slightly.
3. Remove the two screws that hold the “Range Hub” to the main cam body. Note that the longer screw threads into the cable post of the hub, and the shorter screw threads directly into the hub.

BOTTOM CAM

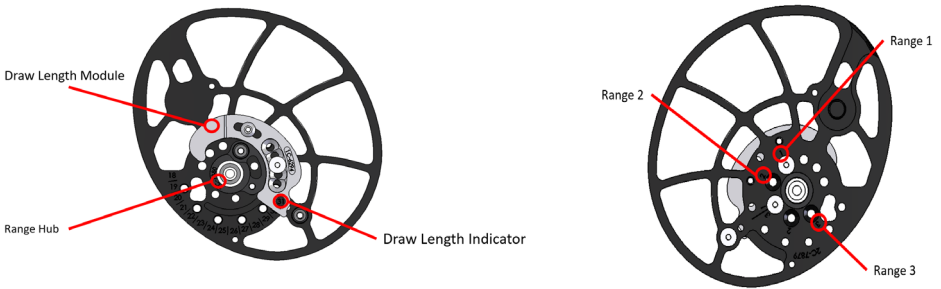

TOP CAM

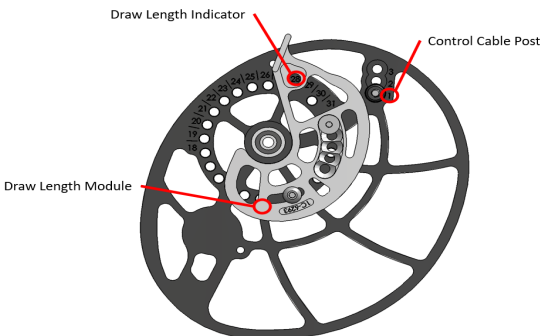

4. Rotate the hub to the desired range setting and replace the two screws.
5. While the bow is still in the press, set the “Control Cable Post” on the top cam to the same range setting as the bottom cam. This will ensure that the cam timing is correct.
6. Remove the bow from the press and double check that all cables and strings are in the correct position.
7. Re-install the bottom module at the desired draw length setting, and **adjust the top module to the same draw length setting**. Both the bottom and top modules should be set to the same desired draw length setting. All draw length settings within each range can be adjusted without a press.

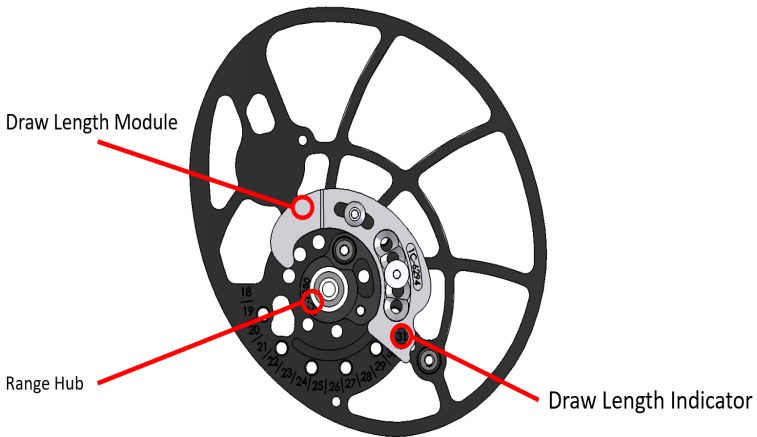

As shown in the pictures, the RANGE HUB and CONTROL CABLE POST are both set to RANGE “1” and the bottom and top draw length modules are set to 31. This means the bow’s DRAW LENGTH is 31 inches. Both the bottom and top modules should be set to the same desired draw length setting.

DRAW LENGTH CHART - XR HYBRID CAM "2025"

DRAW LENGTH	RANGE	LEGEND XR & 30 0 TURNS OUT	LEGEND XR & 30 10 TURNS OUT
18	3	40-44	12-16
18.5	3	42-46	13-17
19	3	45-49	14-18
19.5	3	47-51	15-19
20	3	49-53	16-20
20.5	3	50-54	17-21
21	3	52-56	18-22
21.5	3	54-58	18-22
22	2	55-59	19-23
22.5	2	57-61	19-23
23	2	58-62	20-24
23.5	2	59-63	21-25
24	2	60-64	21-25
24.5	2	61-65	22-26
25	2	62-66	23-27
25.5	2	63-67	23-27
26	2	64-68	24-28
26.5	1	65-69	24-28
27	1	65-69	25-29
27.5	1	66-70	26-30
28	1	66-70	27-31
28.5	1	66-70	27-31
29	1	67-71	28-32
29.5	1	67-71	29-33
30	1	68-72	30-34
31	1	68-72	30-34

OPTIONAL Limb Stop Installation Instructions for LEGEND XR & 30

LIMB STOP INFORMATION

A limb stop provides a harder back wall to the valley and is strictly shooter preference. The limb stop is not required to shoot the bow.

!!! IMPORTANT !!!

**SAFETY FIRST – USE SAFETY GLASSES
TAKE ALL APPROPRIATE SAFETY MEASURES**

THIS TASK MUST BE COMPLETED ON A DRAW BOARD

1. Remove limb stop and bolts from bag
2. Only install the limb stop once all other bow adjustments are made
3. Limb stop is only installed on **TOP XR CAM**
4. With the bow at full draw **on the draw board**, position the limb stop so the O-ring slightly touches the limb (picture D4)
5. Install the adjustment bolts to 11 inch-lbs



A1

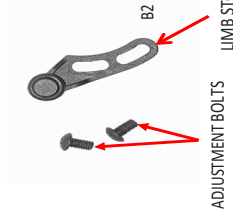

ADJUSTMENT BOLTS

LIMB STOP

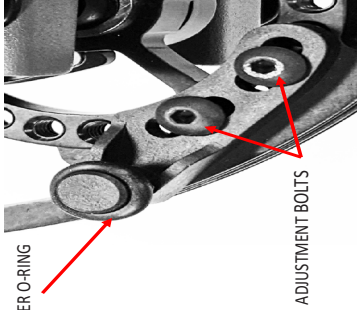

RUBBER O-RING

ADJUSTMENT BOLTS

TOP XR CAM

C3

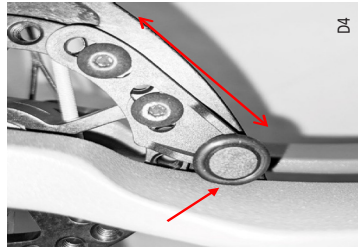

D4

Position the limb stop so the O-ring slightly touches the limb at full draw



E5



F6

Correctly installed limb stop on **TOP XR CAM**

CAM ADJUSTMENTS

Dual Cam Systems

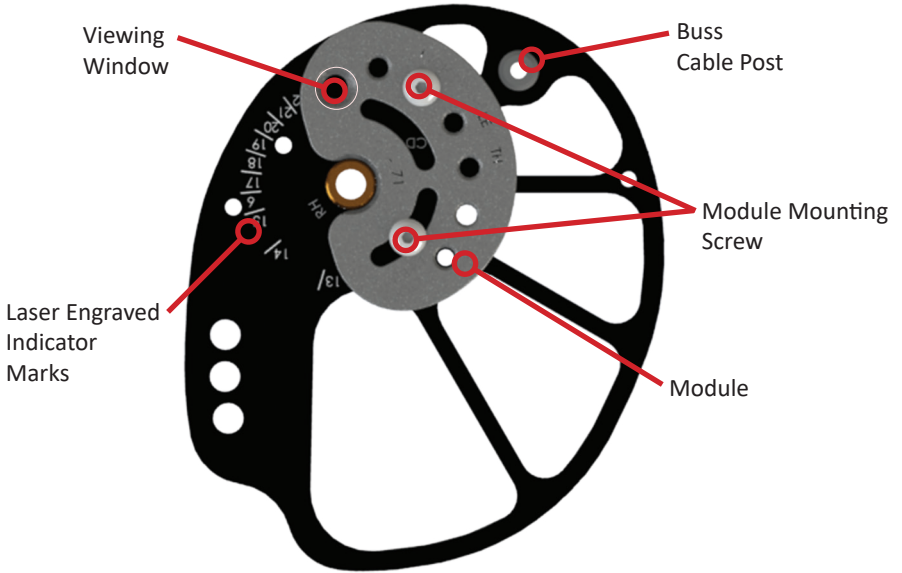

RH CAM - Front View

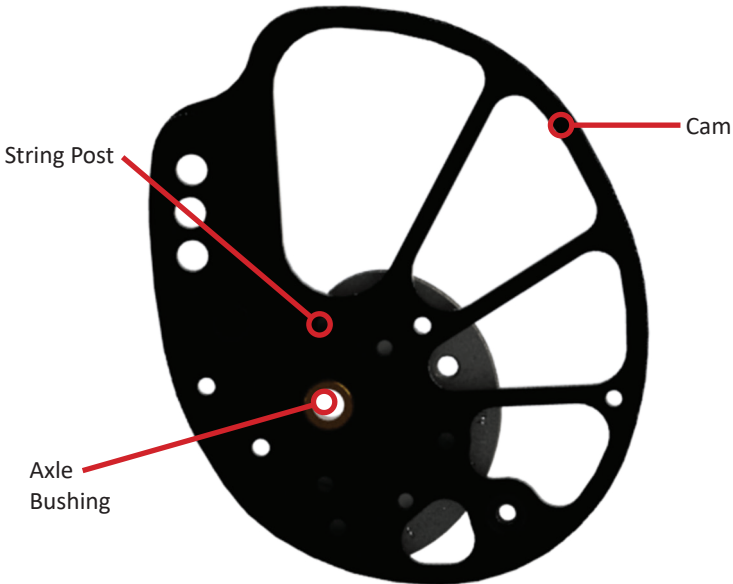

RH CAM - Back View

CAM ADJUSTMENTS

- Adjusting Draw Length -
Dual Cam System

For inch adjustments, simply rotate the inch adjustment module until the viewing window displays the desired draw length. This applies to both the top and bottom modules.

Example shows 26''
draw length.



CAM ADJUSTMENTS

- Adjusting Draw Length -
Single Cam Systems

DRAW LENGTH CHART - SINGLE CAMS "2025"								
MODULE SETTING	ADAPT & 2	RESURGENCE LD	WHITETAIL LEGEND	SPECIES	SPECIES XT	SPECIES EV	SPECIES LD	PROWESS
3	24	25	23		23.5	23.5	25	
3.5	24.5	25.5	23.5		24	24	25.5	
4	25	26	24	24	24.5	24.5	26	
4.5	25.5	26.5	24.5	24.5	25	25	26.5	
5	26	27	25	25	25.5	25.5	27	23
5.5	26.5	27.5	25.5	25.5	26	26	27.5	23.5
6	27	28	26	26	26.5	26.5	28	24
6.5	27.5	28.5	26.5	26.5	27	27	28.5	24.5
7	28	29	27	27	27.5	27.5	29	25
7.5	28.5	29.5	27.5	27.5	28	28	29.5	25.5
8	29	30	28	28	28.5	28.5	30	26
8.5	29.5	30.5	28.5	28.5	29	29	30.5	26.5
9	30	31	29	29	29.5	29.5	31	27
9.5	30.5	31.5	29.5	29.5	30	30	31.5	27.5
10	31	32	30	30	30.5	30.5	32	28
10.5								
11								

CAM ADJUSTMENTS

- Adjusting Draw Length -
Single Cam Systems

The rotating module cam system allows the bow to be adjusted to all of its draw length positions without the use of separate individual modules and does not require a bow press for draw length adjustments at 1/2" increments. Draw length changes are made by first removing the socket head cap screws that secure the rotating module unit. Next, rotate the module until the desired module draw length module tick mark is lined up with the cam tick mark, and reinstall the screws in the corresponding holes. Such draw length adjustments will not affect peak draw weight. When the rotating module unit is repositioned to adjust draw length, the draw stop must also be moved to the corresponding setting marked on the cam. The limb stop can then be installed at the corresponding draw length location if desired. A limb stop provides a harder back wall to the valley and is strictly shooter preference. The limb stop is not required to shoot the bow.

CAM ADJUSTMENTS

Single Cam Systems

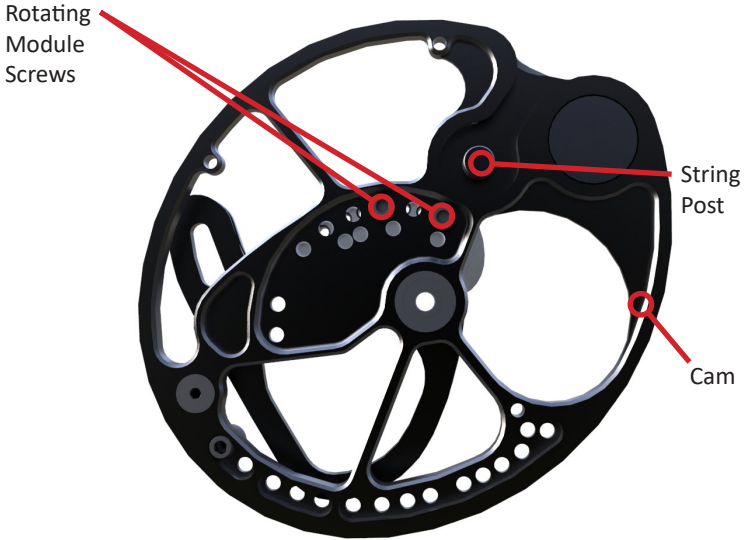

RH Front View



RH Back View

CAM ADJUSTMENTS

Single Cam Systems with limb stop

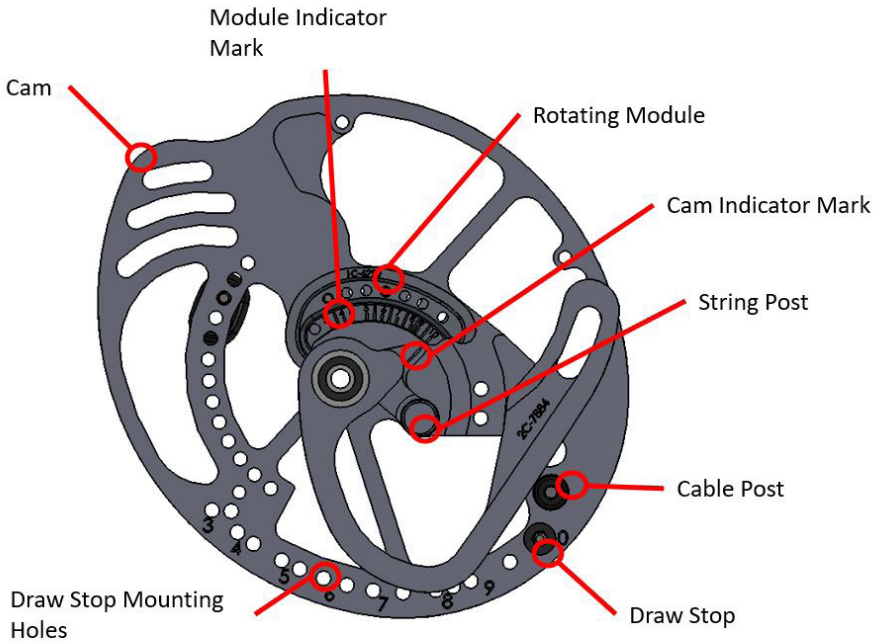
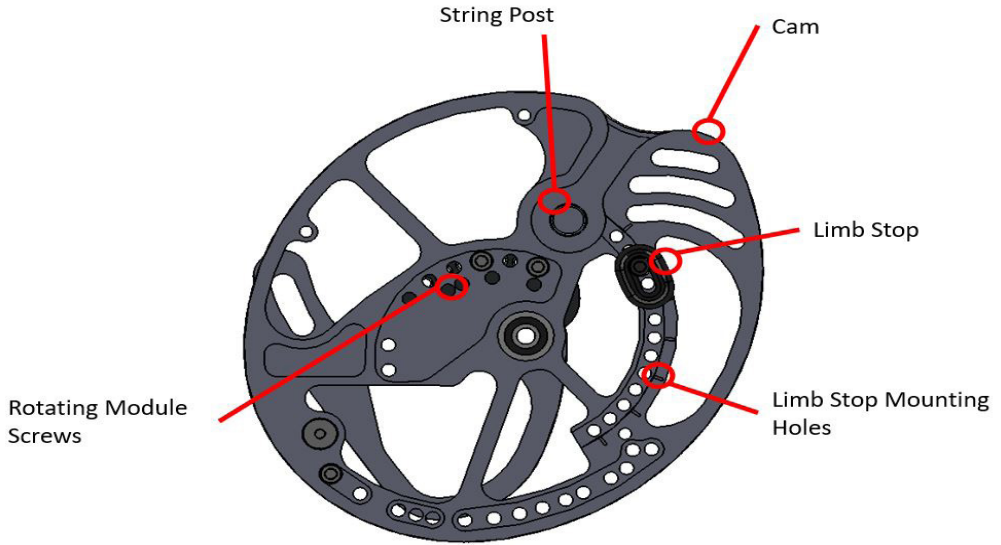

BACK VIEW

INITIAL BOW SETUP

Before you can safely and effectively shoot your bow, a number of specific initial bow setup steps must be taken. These steps can be performed on your own, if your level of expertise is adequate. Or, your local Bear Archery dealer can help you.

Arrow Rest Installation & Setup

Arrow rests should be installed according to the manufacturer's specifications. The first adjustment you need to perform is setting the vertical height of your arrow rest. When properly adjusted, your arrow rest should align the centerline of the arrow with the center of the two holes used to mount the rest to the riser. To check this, place an arrow in the rest and nocked on the string. Visually confirm the center of the arrow passes directly through the center of the arrow rest mounting holes when viewed from the side. If not, adjust your rest up or down to correct.

Next, the rest should be adjusted for proper "Center shot". With an arrow in the rest and nocked on the string, firmly hold another arrow against the inside of the riser near the arrow rest mounting holes as illustrated. Look down the arrows and verify that the arrows are parallel to each other. In other words, the spacing between the two arrows should be the same along the entire length of the arrows. If not, adjust your rest side to side to correct. This is only your "initial" center shot and additional fine tuning may be required depending on your shooting style and equipment. Please refer to the images on the next page for further reference.

Nocking Point and Nock Adjustment

Now that the initial center shot setting is complete, you need to verify your arrow nocking point. Install the nocking point or string loop on the bowstring so that when an arrow is nocked it creates a 90 degree angle to the string. Another option is to use a process similar to the one used to determine center shot. With an arrow in the rest and nocked on the string, firmly hold another arrow against the shelf of the riser as illustrated. Look down the arrows and verify that the arrows are parallel. In other words, the spacing between the two arrows should be the same along the entire length of the arrows. If not, adjust your nocking point up or down to correct.

At this time, adjust arrow fletch position to correspond with the arrow rest you are using. Such adjustments are done by simply rotating or replacing the arrow's nock. Carefully position the nock to provide proper fletch clearance through the arrow rest. Your local Bear Archery dealer can show you how to do this or can provide the service for you. Please refer to the images on the next page for further reference.

Install All Accessories

After your arrow rest and nocking point are installed correctly you will need to install all other accessories such as sights, quivers, silencers, peep sights, stabilizers, etc. Before mounting ANY accessories to the limbs, Refer to page 3 for important limb information.

INITIAL BOW SETUP



Place arrow firmly against inside of riser shown.

Arrow rest should support the arrow in such a way that the arrow's centerline passes directly through the center of the two arrow rest mounting holes. $13/16$ " is a good starting point.

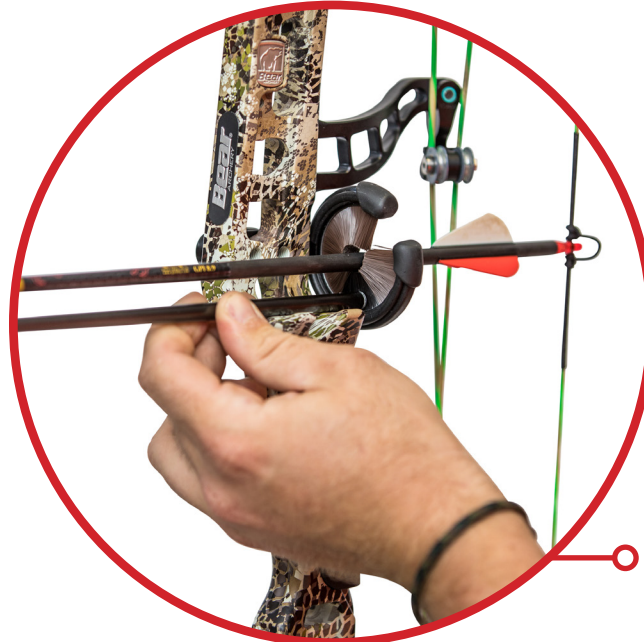

Arrows should be parallel along their entire length.

INITIAL BOW SETUP

Arrow Alignment

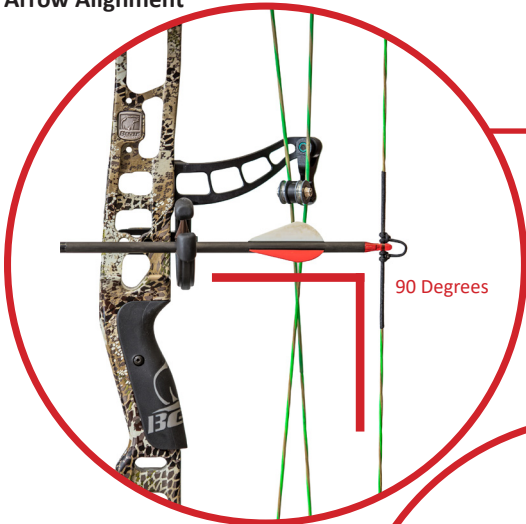

The arrow should make a 90 degree angle with the string.

Place arrow firmly against shelf of riser as shown.



Arrows should be parallel along their entire length.

INITIAL BOW SETUP

Sight Adjustment

When first sighting in your new bow or bow sight, the key thing to remember is “Chase the arrows”. In other words, if your arrows are hitting the target to the right of the bull’s-eye, move your sight to the right. If the arrows hit low on the target, lower your sight.



Arrow Group

In the picture above, the arrows are hitting the target low and to the right of the bull’s-eye. To correct this, adjust your sight down and to the right. Remember, “Chase the arrows.”

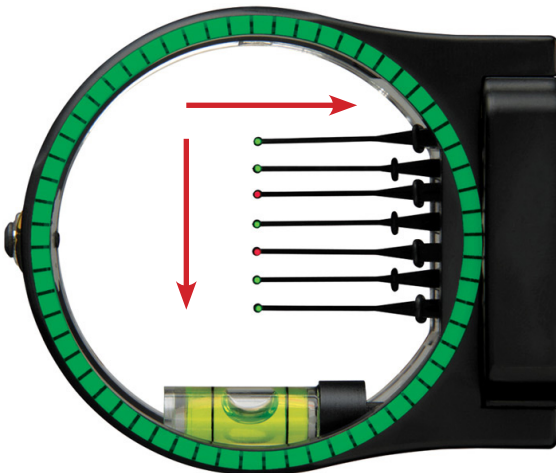

ARROW SELECTION

Arrow selection depends on the peak draw weight, let-off and draw length settings of your bow. Refer to arrow manufacturer's arrow selection tables using this information. The International Bowhunters Organization (IBO) allows a minimum of five grains arrow weight per pound of peak weight. Arrow weight is the total combined weight of your arrow nock, fletching, insert, and point or broadhead. To determine the lightest arrow you can safely shoot, use the following format:

Peak Draw Weight(Lb)	X	Multiply by 5 Grains per Pound	=	Minimum Safe Arrow Weight (Grains)
-------------------------	---	--------------------------------------	---	------------------------------------------

⚠ WARNING ⚠

Shooting arrows below these minimum weight requirements will void the warranty. Using arrows below five grains per pound of peak weight can approach dry-fire conditions and can severely reduce the life of your bow, and may cause serious injury. Contact your local Bear Archery pro shop or arrow manufacturers for arrow selection recommendations.

The weight of the arrow you select can be determined as follows:

1. From an arrow chart, find the weight of your arrow shaft based on the size and length.
2. Add the weight of your broadhead or point.
3. Add 35 grains to cover the nock, insert, and fletching.

For example:

Arrow 400-30" 240 Gr	+	Point Mag 125 (+125 Gr)	+	Other (+35 Gr)	=	Total Weight (=400 Gr)
----------------------------	---	-------------------------------	---	-------------------	---	------------------------------

NOTE: It is always best to use a grain scale when available.

BEAR ARCHERY WARRANTY STATEMENT

All Bear Archery compound bows are backed with a Limited Lifetime Warranty to the original owner against manufacturer defects. This warranty applies to limbs, risers, and cams. This warranty consists of the following programs:

Limbs: 100% covered at no charge for the first 5 years, 50% of replacement cost after.

•Risers: Lifetime Warranty.

•Cams: Lifetime Warranty.

Original Owner

Warranty applies only to the original owner and is not transferable. Proof of purchase may be required.

Items Not Covered

Cables, strings, suppressors, bearings.

Damage Not Covered

Damage caused by abuse, mishandling, dry firing, normal wear and tear of paint and/or film dipped finishes and alteration or modifications made to original product are not covered under this warranty. The use of any bow press other than those approved by Bear Archery will void this warranty. Additionally, shooting of arrows less than 5 grains per pound of draw weight will void the warranty. Bear Archery reserves the right to make parts substitutions or replace products with similar product of the same value on warranty coverage at Bear Archery's sole discretion, for any reason.

Bow Warranty Registration

For this warranty to be in effect, the on-line warranty registration process must be completed at BearArchery.com and submitted within 30 days of purchase. Keep a copy of your receipt to show you are the original owner.

Traditional Bows

1 year Limited Warranty to the original owner.

Youth Bows

90 Day Limited Warranty to the original owner.

In the event a bow requires warranty service, please contact the Bear Archery Customer Department at 800-694-9494 for a return authorization (RA) number and return shipping instructions. For full warranty details, please log on to beararchery.com for further information.

Key Contact data

Bear Archery Customer Service: 800-694-9494

4600 SW 41st Blvd.

Gainesville, FL 32608

bearcustomercare@beararchery.com

Web: www.BearArchery.com

©2025 Bear Archery

2L-7213-25