



FABRIQUÉ PAR :  
Backyard Discovery  
3305 Airport Drive, Pittsburg, KS 66762  
800-856-4445

Basepoint Business Centre : Rivermead Drive, Westlea, Swindon SN5 7EX Téléphone : 0800-118-2476  
J.P. Coenstraat 7, The Bridge, La Haye, 2595 WP, Pays-Bas Téléphone : 08005678990

# HILLCREST

## Balançoire

### MODÈLE : n° 1808058B



#### AVERTISSEMENT

*Assemblage par un adulte nécessaire.*

Ne convient pas aux enfants de moins de 36 mois en raison de petites pièces.

RÉSERVÉ UNIQUEMENT À UN USAGE DOMESTIQUE. DESTINÉ À UNE UTILISATION EN EXTÉRIEUR.



**Veillez visiter [www.backyarddiscovery.com](http://www.backyarddiscovery.com)**

Pour obtenir le manuel de montage le plus récent, pour enregistrer votre ensemble ou pour commander des pièces de rechange  
*Para obtener instrucciones en español, visite [www.backyarddiscovery.com](http://www.backyarddiscovery.com)*



**ÉTAPE PAR ÉTAPE FACILE**  
INSTRUCTIONS INTERACTIVES EN 3D  
TÉLÉCHARGEZ L'APPLICATION GRATUITE



**SERVICES  
D'INSTALLATION  
DISPONIBLES!\***

*Voir à l'intérieur pour les détails*

Fabriqué en Chine  
INS-1808058B-A-HILLCREST-FR 01/04/2022

# Manuel du propriétaire - Dimensions d'installation de base et notes relatives au montage

Placez la balançoire sur un terrain plat, à au moins 2 m [6 pi - 7 po] de toute structure ou obstruction, telle qu'une clôture, un garage, une maison, des branches en surplomb, des cordes à linge ou des fils électriques.

•Pendant le montage de l'unité, prenez le temps, avant et après chaque phase, de vous assurer que le fort est deniveau. Si le fort n'est pas de niveau, le montage sera difficile et il pourrait en résulter un montage incorrect. Des précautions supplémentaires doivent être prises pour vous assurer que les angles du fort soient bien droits.

•L'aire de jeu sécuritaire fait référence à une zone s'étendant sur 2 m (6 pi - 7 po) au-delà de l'ensemble de jeu, sur tous les côtés, y compris l'espace situé au-dessus de l'ensemble de jeu.

## SCHÉMA DE LA ZONE DE JEU SÉCURITAIRE

### Dimensions au sol

18 pi - 3 3/4 po [5.6 m] x 13 pi - 5 1/2 po [4.1 m]

### Zone de jeu sécuritaire

31 pi - 5 3/4 po [9.6 m] x 26 pi - 7 1/2 po [8.1 m] x 16 pi - 1 1/4 po [4.9 m]

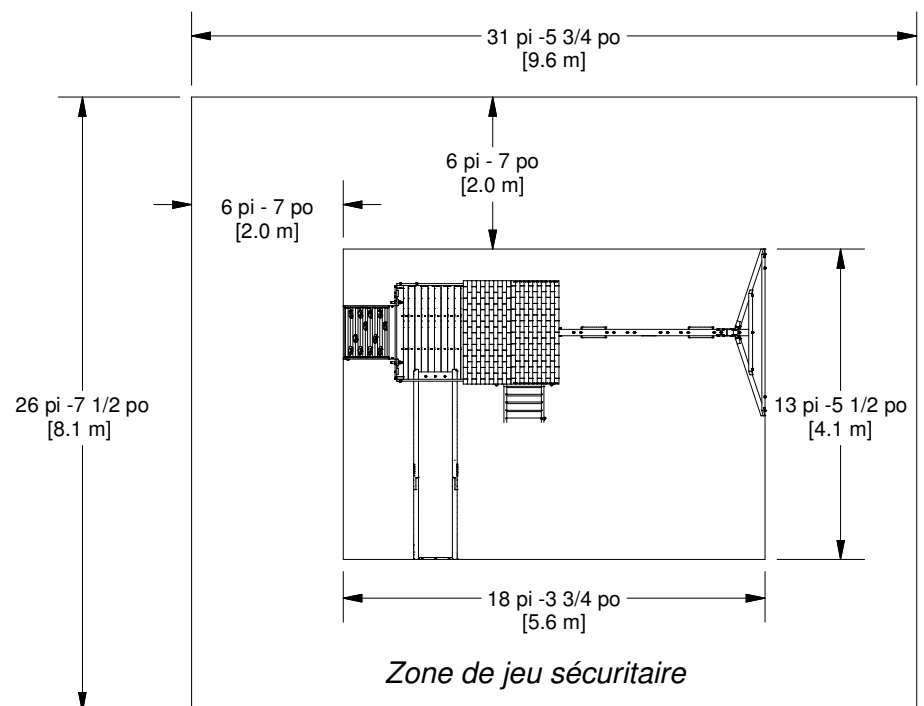

**HAUTEUR DE JEU SÉCURITAIRE: 16 pi -1 1/4 po [4.9 m]**  
**HAUTEUR DE CHUTE MAXIMALE: 6 pi -11 1/4 po [2.1 m]**

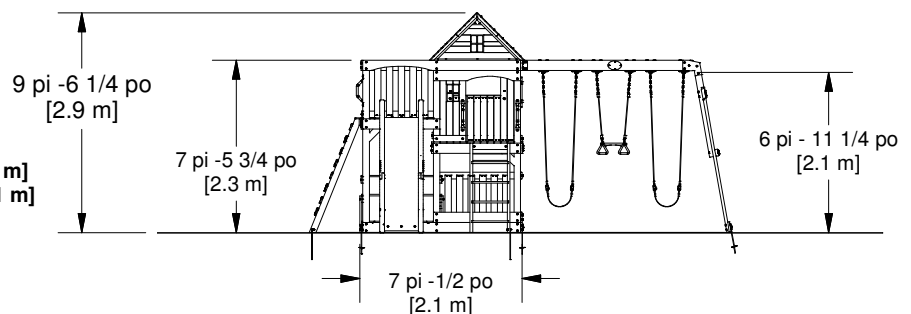

### Informations générales :

Votre ensemble de jeu a été conçu et étudié pour les enfants uniquement et pour un usage résidentiel uniquement.

Un maximum de 68 kg (150 lb) par enfant est recommandé pour toutes les activités ludiques conçues pour un usage individuel.

Un maximum de 54 kg (120 lb) par enfant est recommandé pour les activités ludiques conçues pour plusieurs enfants.

Le nombre maximum d'enfants recommandé pour cette balançoire est de 9.

# Manuel du propriétaire - Identification des pièces

## Composants en bois (pas à l'échelle)



**A50** | POUTRE DE LA BALANÇOIRE - W4L15998  
(x1) |  $3 \frac{3}{8}$  po x  $5 \frac{1}{4}$  po x  $89 \frac{1}{2}$  po (86 x 134 x 2274)



**E01** | PIED DE TOUR AVANT DROIT - W4L15999  
(x1) |  $1 \frac{3}{8}$  po x  $3 \frac{3}{8}$  po x  $89 \frac{1}{2}$  po (36 x 86 x 2274)

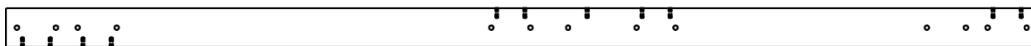

**E02** | PIED DE TOUR AVANT CENTRE - W4L16000  
(x1) |  $1 \frac{3}{8}$  po x  $3 \frac{3}{8}$  po x  $89 \frac{1}{2}$  po (36 x 86 x 2274)

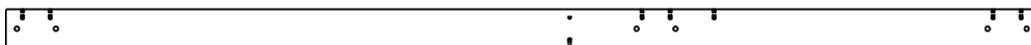

**E03** | PIED DE TOUR AVANT GAUCHE - W4L16001  
(x1) |  $1 \frac{3}{8}$  po x  $3 \frac{3}{8}$  po x  $89 \frac{1}{2}$  po (36 x 86 x 2274)

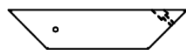

**E04** | CALE DE LA PLATEFORME - W4L16002  
(x8) |  $1 \frac{3}{8}$  po x  $3 \frac{3}{8}$  po x  $15 \frac{1}{2}$  po (36 x 86 x 394)

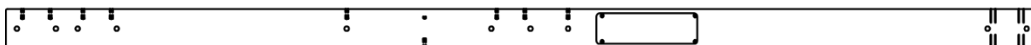

**E05** | PIED DE TOUR ARRIÈRE DROIT - W2A03282  
(x1) |  $1 \frac{3}{8}$  po x  $3 \frac{3}{8}$  po x  $89 \frac{1}{2}$  po (36 x 86 x 2274)

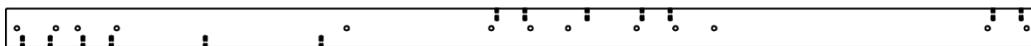

**E06** | PIED DE TOUR ARRIÈRE CENTRE - W4L16005  
(x1) |  $1 \frac{3}{8}$  po x  $3 \frac{3}{8}$  po x  $89 \frac{1}{2}$  po (36 x 86 x 2274)

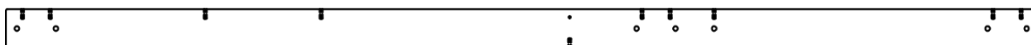

**E07** | PIED DE TOUR ARRIÈRE GAUCHE - W4L16006  
(x1) |  $1 \frac{3}{8}$  po x  $3 \frac{3}{8}$  po x  $89 \frac{1}{2}$  po (36 x 86 x 2274)

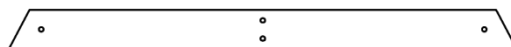

**E50** | SUPPORT D'EXTRÉMITÉ - W4L16003  
(x1) |  $1 \frac{3}{8}$  po x  $3 \frac{3}{8}$  po x  $44 \frac{1}{8}$  po (36 x 86 x 1120)



**E51** | CALE ANGULAIRE - W4L16004  
(x2) |  $1 \frac{7}{16}$  po x  $3 \frac{3}{8}$  po x  $87 \frac{3}{16}$  po (36 x 86 x 2214)

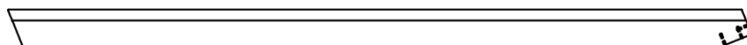

**E72** | RAIL GAUCHE - W4L16007  
(x1) |  $1 \frac{3}{8}$  po x  $3 \frac{3}{8}$  po x  $64 \frac{1}{2}$  po (36 x 86 x 1640)

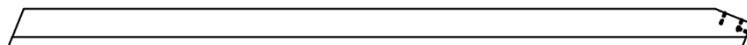

**E73** | RAIL DROIT - W4L16008  
(x1) |  $1 \frac{3}{8}$  po x  $3 \frac{3}{8}$  po x  $64 \frac{1}{2}$  po (36 x 86 x 1640)

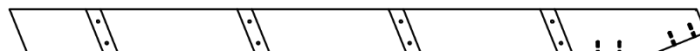

**E74** | MONTANT GAUCHE - W4L16028  
(x1) |  $1 \frac{3}{8}$  po x  $3 \frac{3}{8}$  po x  $50 \frac{3}{4}$  po (36 x 86 x 1290)

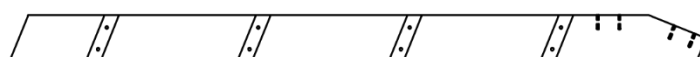

**E75** | MONTANT DROIT - W4L16029  
(x1) |  $1 \frac{3}{8}$  po x  $3 \frac{3}{8}$  po x  $50 \frac{3}{4}$  po (36 x 86 x 1290)

# Manuel du propriétaire - Identification des pièces

## Composants en bois (pas à l'échelle)

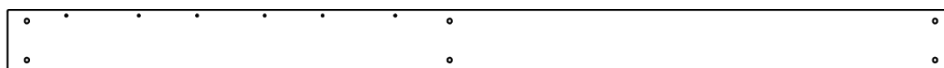

**G01** | PANNEAU DE LA BASE - W4L16009  
(x2) 5/8 po x 5 1/4 po x 82 1/4 po (16 x 134 x 2088)

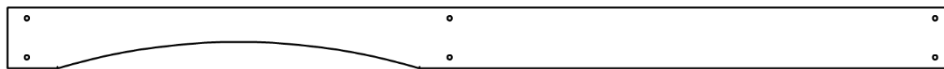

**G02** | LISSE MURALE - W4L16015  
(x1) 1 po x 5 1/4 po x 82 1/4 po (24 x 134 x 2088)

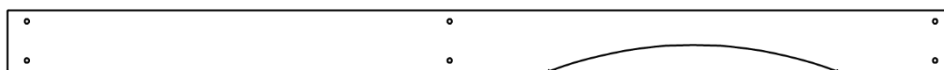

**G03** | LISSE MURALE - W4L16016  
(x1) 1 po x 5 1/4 po x 82 1/4 po (24 x 134 x 2088)



**G04** | LISSE DE PLANCHER - W4L16017  
(x2) 5/8 po x 5 1/4 po x 49 po (16 x 134 x 1244)

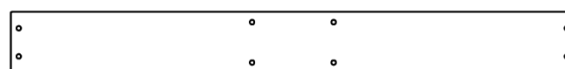

**G05** | LISSE MURALE/SUPPORT DE LA BALANÇOIRE -  
(x1) W4L16018 1 po x 5 1/4 po x 49 po (24 x 134 x 1244)



**G06** | LISSE DE PLANCHER - W4L16020  
(x1) 1 po x 5 1/4 po x 49 po (24 x 134 x 1244)



**G07** | LISSE DE PLANCHER - W4L16021  
(x2) 1 po x 5 1/4 po x 49 po (24 x 134 x 1244)

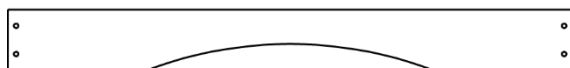

**G08** | LISSE MURALE - W4L16022  
(x2) 1 po x 5 1/4 po x 49 po (24 x 134 x 1244)



**G09** | LISSE DE PLANCHER - W4L16036  
(x1) 1 po x 5 1/4 po x 49 po (24 x 134 x 1244)



**G10** | LISSE DE PLANCHER - W4L16010  
(x1) 1 po x 5 1/4 po x 45 1/2 po (24 x 134 x 1156)



**G11** | PLATEAU DE LA TABLE DE PIQUE-NIQUE -  
(x2) W4L16011 5/8 po x 5 1/4 po x 42 po  
(16 x 134 x 1066)



**G12** | LISSE DE PLANCHER - W4L16012  
(x2) 1 po x 5 1/4 po x 40 1/8 po (24 x 134 x 1018)

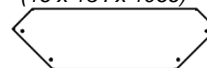

**G13** | SIÈGE DE BAC À SABLE - W4L16013  
(x2) 1 po x 5 1/4 po x 17 3/4 po (24 x 134 x 450)



**G14** | PLANCHE DE SOL - W4L16019  
(x1) 15/16 po x 5 1/4 po x 86 11/16 po (24 x 134 x 2202)

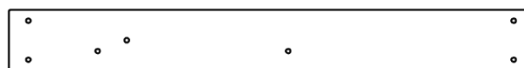

**G15** | LISSE DE PLANCHER - W4L16014  
(x1) 1 po x 5 1/4 po x 45 1/2 po (24 x 134 x 1156)

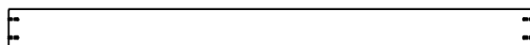

**H01** | SOLIVE DE SOL - W4L16023  
(x2) 1 po x 3 3/8 po x 45 1/2 po (24 x 86 x 1156)

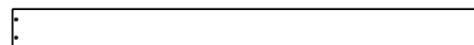

**H02** | SIÈGE DE TABLE DE PIQUE-NIQUE -  
(x2) W4L16025 1 po x 3 3/8 po x 41 3/8 po  
(24 x 86 x 1050)



**H03** | SOLIVE DE PLANCHER - W4L16026  
(x2) 1 po x 3 3/8 po x 40 1/8 po (24 x 86 x 1018)

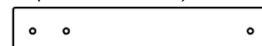

**H04** | MONTANT DE SIÈGE - W4L16027  
(x2) 1 po x 3 3/8 po x 19 po (24 x 86 x 482)

# Manuel du propriétaire - Identification des pièces

## Composants en bois (pas à l'échelle)



**H05** | SUPPORT DE PLANCHE DE PLANCHER INFÉRIEUR - W4L16024  
(x10) | 1 po x 3 3/8 po x 5 1/4 po (24 x 86 x 134)

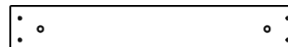

**H06** | PLANCHE SUPÉRIEURE DE L'ÉCHELLE - W4L16088  
(x1) | 1 po x 3 3/8 po x 21 po (24 x 86 x 532)



**H07** | ÉCHELON - W4L16030  
(x4) | 15/16 po x 3 3/8 po x 18 7/8 po (24 x 86 x 480)



**H08** | SUPPORT DE TABLE - W4L16031  
(x2) | 1 po x 3 3/8 po x 12 po (24 x 86 x 306)

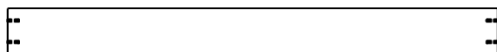

**H09** | SOLIVE DE SOL - W4L16032  
(x2) | 1 po x 3 3/8 po x 35 3/4 po (24 x 86 x 908)

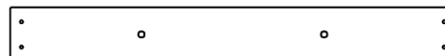

**H10** | PLANCHE DE FIXATION - W4L16045  
(x1) | 1 po x 3 3/8 po x 27 7/8 po (24 x 86 x 707)



**J01** | CHEVRON DE TOIT - W4L16033  
(x4) | 1 po x 2 3/8 po x 33 5/8 (24 x 60 x 854)



**K01** | LISSE MURALE - W4L16034  
(x1) | 5/8 po x 5 1/4 po x 45 1/2 po (16 x 134 x 1156)



**K02** | PANNEAU DE BASE/BAC À SABLE - W4L16035  
(x3) | 5/8 po x 5 1/4 po x 49 po (16 x 134 x 1244)

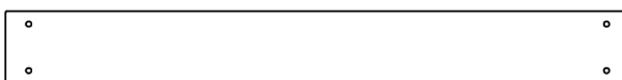

**K03** | PLANCHE DE SOL - W4L16038  
(x2) | 5/8 po x 5 1/4 po x 45 1/2 po (16 x 134 x 1156)



**L01** | PLANCHE DE PLANCHER DE REMPLISSAGE EXTÉRIEURE - W4L16039  
(x3) | 5/8 po x 4 3/8 po x 46 po (16 x 112 x 1168)

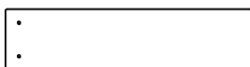

**L02** | PANNEAU MURAL - W4L16040  
(x4) | 5/8 po x 4 3/8 po x 18 po (16 x 112 x 456)



**L03** | PANNEAU MURAL - W4L16041  
(x4) | 5/8 po x 4 3/8 po x 7 po (16 x 112 x 178)

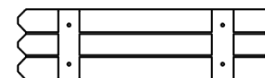

**L04** | VOLET DE FENÊTRE - W4L16042  
(x3) | 5/8 po x 4 3/8 po x 16 po (16 x 112 x 406)



**M01** | CHAPEAU DU TOIT - W4L16043  
(x2) | 5/8 po x 3 3/8 po x 51 7/8 po (16 x 86 x 1318)



**M02** | PLANCHE DE PLANCHER - W4L16055  
(x1) | 5/8 po x 3 3/8 po x 46 po (16 x 86 x 1168)

# Manuel du propriétaire - Identification des pièces

## Composants en bois (pas à l'échelle)

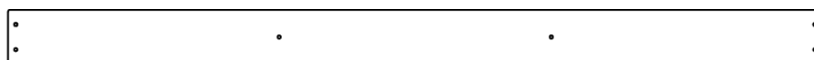

**M03** | PLANCHE DE PLANCHER - W4L16063  
(x20) | 5/8 po x 3 3/8 po x 50 7/8 po (16 x 86 x 1292)



**M04** | PLANCHE DE RIVE DU PIGNON - W4L16065  
(x2) | 5/8 po x 3 3/8 po x 44 po (16 x 86 x 1118)

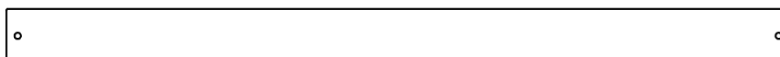

**M05** | LISSE MURALE - W4L16066  
(x3) | 5/8 po x 3 3/8 po x 49 po (16 x 86 x 1244)

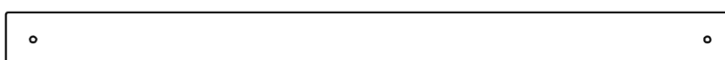

**M06** | LISSE MURALE - W4L16067  
(x2) | 5/8 po x 3 3/8 po x 45 1/2 po (16 x 86 x 1156)

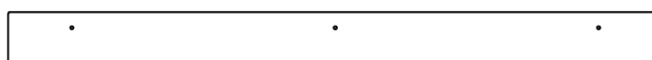

**M07** | CHAPEAU DU MUR - W4L16068  
(x2) | 5/8 po x 3 3/8 po x 40 7/8 po (16 x 86 x 1038)



**M08** | PANNEAU MURAL - W4L16074  
(x11) | 5/8 po x 3 3/8 po x 41 po (16 x 86 x 1040)

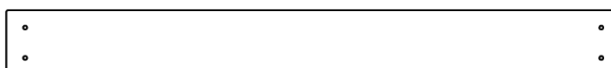

**M09** | PANNEAU MURAL - W4L16075  
(x6) | 5/8 po x 3 3/8 po x 32 po (16 x 86 x 812)

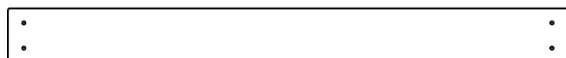

**M10** | PANNEAU MURAL - W4L16044  
(x1) | 5/8 po x 3 3/8 po x 35 po (16 x 86 x 888)

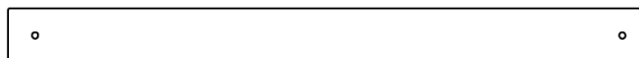

**M11** | LISSE MURALE - W4L16047  
(x1) | 5/8 po x 3 3/8 po x 40 1/8 po (16 x 86 x 1018)

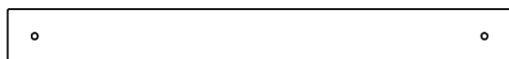

**M12** | ENCADREMENT DE FENÊTRE - W4L16048  
(x1) | 5/8 po x 3 3/8 po x 31 1/2 po (16 x 86 x 800)

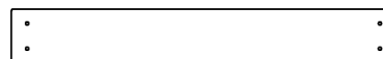

**M13** | PANNEAU MURAL - W4L16049  
(x7) | 5/8 po x 3 3/8 po x 24 po (16 x 86 x 610)



**M14** | SUPPORT DE SIÈGE DE TABLE DE PIQUE-NIQUE - W4L16050  
(x2) | 5/8 po x 3 3/8 po x 22 po (16 x 86 x 558)



**M15** | PLANCHE DE RIVE DU PIGNON - W4L16051  
(x2) | 5/8 po x 3 3/8 po x 19 po (16 x 86 x 482)

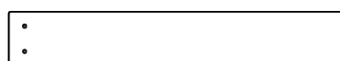

**M16** | PANNEAU MURAL - W4L16052  
(x2) | 5/8 po x 3 3/8 po x 21 po (16 x 86 x 532)



**M17** | PANNEAU MURAL - W4L16090  
(x2) | 5/8 po x 3 3/8 po x 41 po (16 x 86 x 1040)

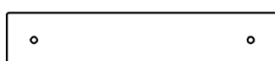

**M18** | LISSE MURALE - W4L16053  
(x1) | 5/8 po x 3 3/8 po x 16 7/8 po (16 x 86 x 430)

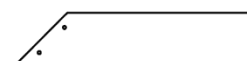

**M19** | PLANCHE DE RIVE DU PIGNON - W4L16054  
(x4) | 5/8 po x 3 3/8 po x 15 1/4 po (16 x 86 x 387)

# Manuel du propriétaire - Identification des pièces

## Composants en bois (pas à l'échelle)



**M20** | PLANCHE DE RIVE DU PIGNON - W4L16056  
(x2) 5/8 po x 3 3/8 po x 12 1/4 po (16 x 86 x 310)

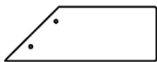

**M22** | PLANCHE DE RIVE DU PIGNON - W4L16058  
(x4) 5/8 po x 3 3/8 po x 9 1/2 po (16 x 86 x 241)



**M24** | PANNEAU MURAL - W4L16061  
(x9) 5/8 po x 3 3/8 po x 29 5/8 po (16 x 86 x 752)

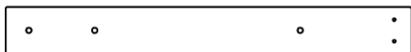

**M26** | PANNEAU MURAL - W4L16091  
(x2) 5/8 po x 3 3/8 po x 29 5/8 po (16 x 86 x 752)

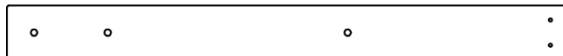

**M28** | PANNEAU MURAL - W4L16064  
(x1) 5/8 po x 3 3/8 po x 35 po (16 x 86 x 888)

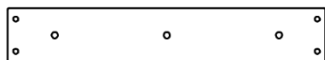

**M70** | SUPPORT DU LIT DE TOBOGGAN - W100935  
(x1) 5/8 po x 3 3/8 po x 19 7/8 po (16 x 86 x 505)



**M74** | PLANCHE DE MUR D'ESCALADE - W4L16071  
(x10) 5/8 po x 3 3/8 po x 26 5/8 po (16 x 86 x 675)



**M76** | PLANCHE DE MUR D'ESCALADE - W4L16073  
(x4) 5/8 po x 3 3/8 po x 26 5/8 po (16 x 86 x 675)



**M108** | PLANCHE SUPÉRIEURE - W4L16046  
(x1) 5/8 po x 3 1/4 po x 27 7/8 po (16 x 82 x 707)

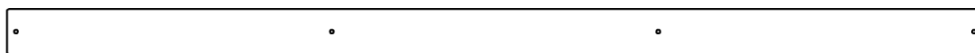

**N01** | PLANCHE DE PLANCHER - W4L16076  
(x1) 5/8 po x 2 3/8 po x 50 7/8 po (16 x 60 x 1292)



**N02** | PLAQUE DE REPRISSE - W4L16077  
(x2) 5/8 po x 2 3/8 po x 5 po (16 x 60 x 126)



**N04** | PLANCHE DE RIVE DU PIGNON - W4L16079  
(x4) 5/8 po x 2 3/8 po x 11 7/8 po (16 x 60 x 301)

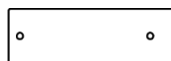

**M21** | LISSE MURALE - W4L16057  
(x2) 5/8 po x 3 3/8 po x 10 1/2 po (16 x 86 x 268)



**M23** | ENCADREMENT DE FENÊTRE - W4L16059  
(x2) 5/8 po x 3 3/8 po x 12 7/8 po (16 x 86 x 328)



**M25** | SUPPORT DE TABLE - W4L16037  
(x2) 5/8 po x 3 3/8 po x 13 1/2 po (16 x 86 x 342)

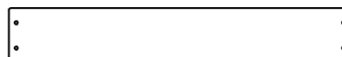

**M27** | PANNEAU MURAL INFÉRIEUR - W4L16062  
(x13) 5/8 po x 3 3/8 po x 21 3/8 po (16 x 86 x 544)



**M29** | PANNEAU MURAL - W4L16060  
(x2) 5/8 po x 3 3/8 po x 5 po (16 x 86 x 126)

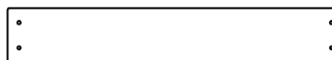

**M73** | SUPPORT ARRIÈRE - W4L16070  
(x1) 5/8 po x 3 3/8 po x 21 po (16 x 86 x 532)



**M75** | PLANCHE DE MUR D'ESCALADE - W4L16072  
(x4) 5/8 po x 3 3/8 po x 26 5/8 po (16 x 86 x 675)



**N03** | PANNEAU MURAL - W4L16078  
(x2) 5/8 po x 2 3/8 po x 18 po (16 x 60 x 456)



**N05** | PANNEAU MURAL - W4L16080  
(x2) 5/8 po x 2 3/8 po x 7 po (16 x 60 x 178)

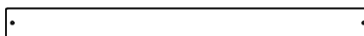

**N06** | PLANCHE DE REMPLISSAGE - W4L16089  
(x1) 5/8 po x 2 1/8 po x 26 5/8 po (16 x 54 x 675)

# Manuel du propriétaire - Identification des pièces

## Composants en bois (pas à l'échelle)



**O01** | SUPPORT MURAL - W4L16081  
(x6) 5/8 po x 1 3/8 po x 13 po (16 x 34 x 330)



**O02** | SUPPORT MURAL - W4L16082  
(x1) 5/8 po x 1 3/8 po x 10 po (16 x 34 x 254)

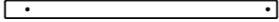

**O03** | LISSE DE SÉCURITÉ - W4L16083  
(x1) 5/8 po x 1 3/8 po x 20 1/2 po (16 x 34 x 520)



**O04** | LAME DE VOLET DE FENÊTRE - W4L16084  
(x6) 5/8 po x 1 3/8 po x 5 3/8 po (16 x 34 x 136)



**SP50** | SUPPORT DE POUTRE DE BALANÇOIRE - W4L16085  
(x1) 3 3/8 po x 3 3/8 po x 49 3/8 po (86 x 86 x 1254)



**T01** | SUPPORT DE SIÈGE - W4L16086  
(x4) 1 po x 1 3/8 po x 4 3/8 po (24 x 34 x 112)



**Y01** | PLANCHE DE PLANCHER DE REMPLISSAGE EXTÉRIEURE - W4L16087  
(x1) 5/8 po x 4 po x 46 po (16 x 102 x 1168)

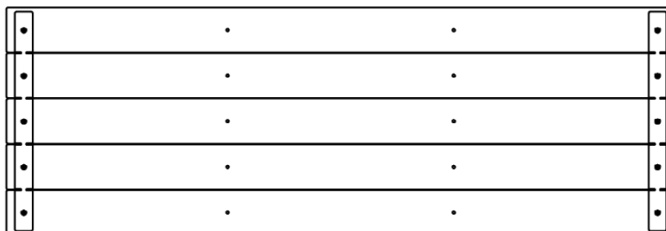

**FP1** | PANNEAU DE PLANCHER - W2A03281  
(x1) 1 5/8 po x 17 1/8 po x 50 1/4 po (40 x 434 x 1276)

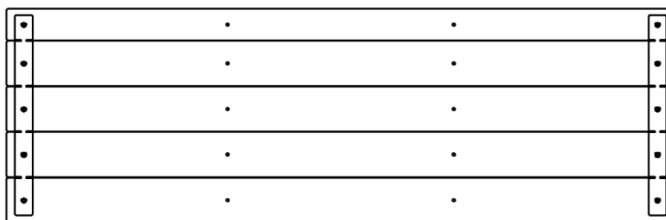

**FP2** | PANNEAU DE PLANCHER - W2A03282  
(x1) 1 5/8 po x 16 1/8 po x 50 1/4 po (40 x 408 x 1276)

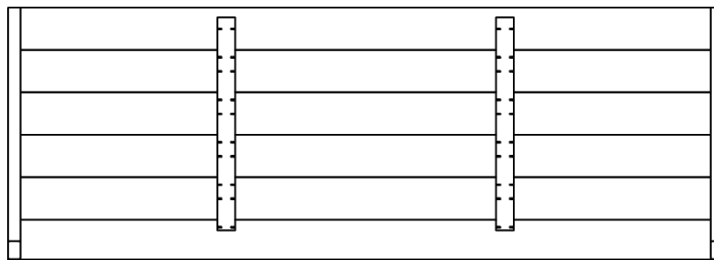

**RP1** | PANNEAU DE TOIT - W2A03279  
(x2) 1 3/4 po x 19 1/4 po x 53 3/4 po (45 x 490 x 1366)

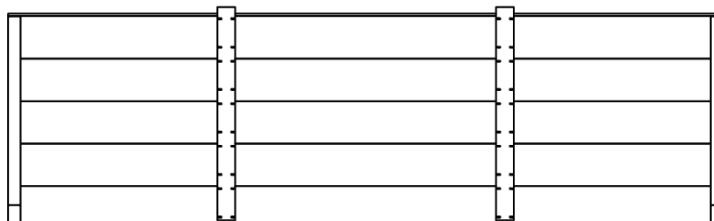

**RP2** | PANNEAU DE TOIT - W2A03280  
(x2) 1 3/4 po x 16 1/4 po x 53 3/4 po (45 x 417 x 1366)

# Manuel du propriétaire - Identification des pièces

## Pièces de quincaillerie

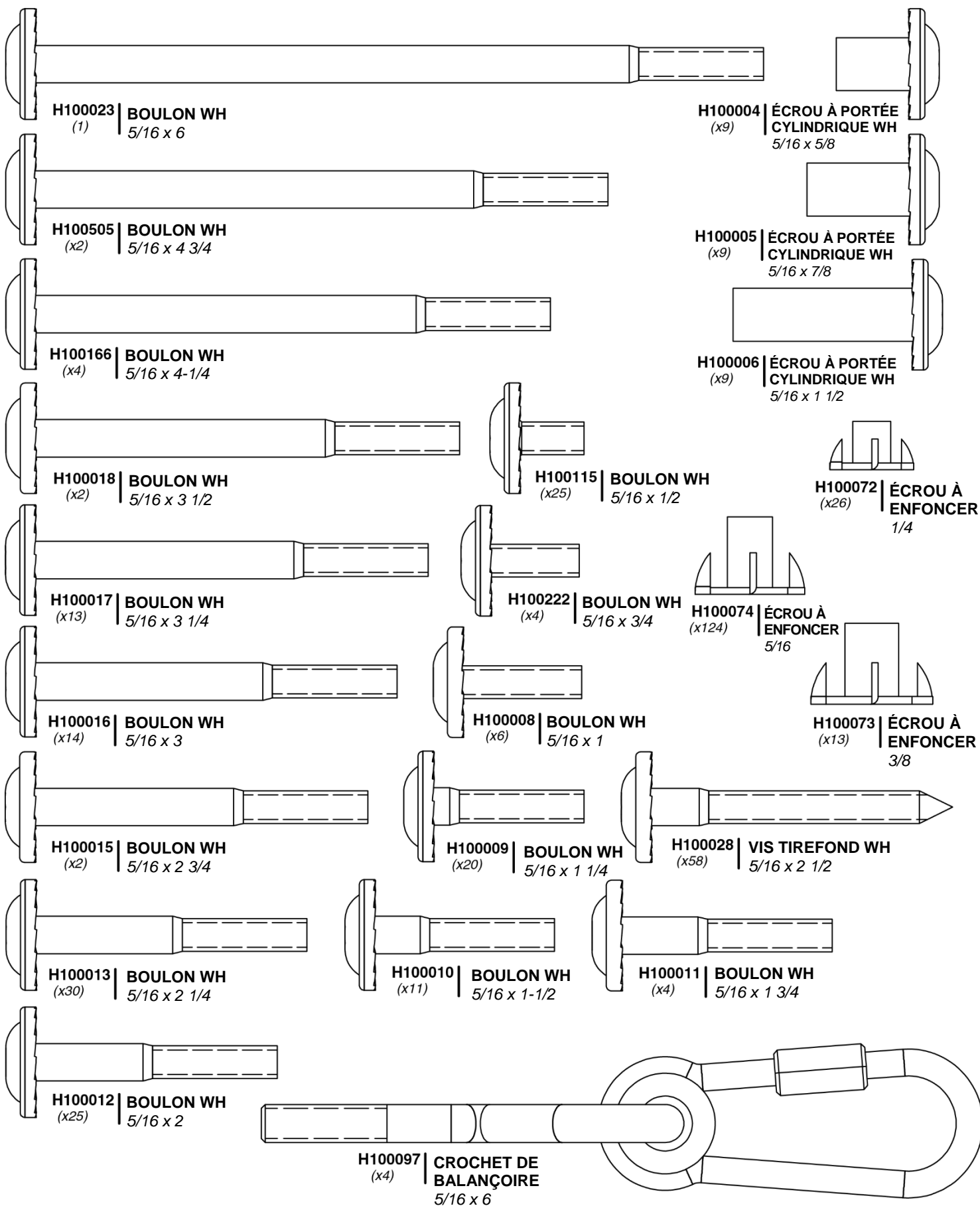

# Manuel du propriétaire - Identification des pièces

## Pièces de quincaillerie

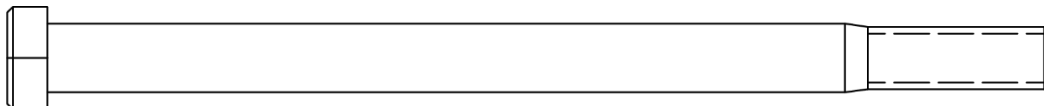

**H100654** | BOULON HEXAGONAL  
(x13) | 3/8 x 5-1/2

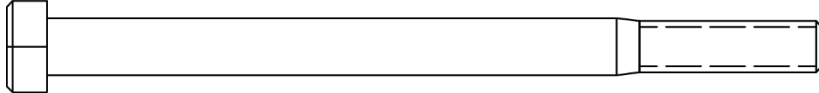

**H100054** | BOULON HEXAGONAL  
(x2) | 5/16 x 4 1/4

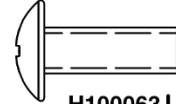

**H100063** | BOULON PTH  
(x26) | 1/4 x 3/4

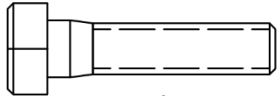

**H100042** | BOULON HEXAGONAL  
(x4) | 5/16 x 1 1/4

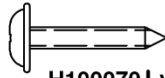

**H100070** | VIS TÊTE BOMBÉE CRUCIFORME PWH  
(x22) | 8 x 3/4

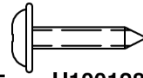

**H100128** | VIS TÊTE BOMBÉE CRUCIFORME PWH  
(x2) | 8 x 5/8

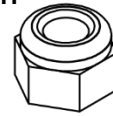

**H100110** | ÉCROU AUTOBLOQUANT  
(x2) | 5/16

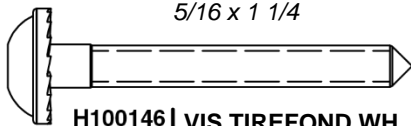

**H100146** | VIS TIREFOND WH  
(x9) | 1/4 x 2

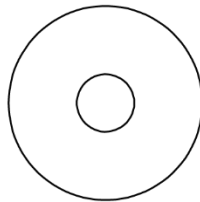

**H100105** | RONDELLE PLATE  
(x9) | 8 x 27

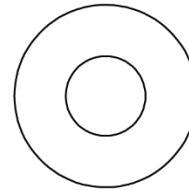

**H100102** | RONDELLE PLATE  
(x13) | 11 x 25

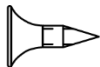

**H100124** | VIS TÊTE PLATE CRUCIFORME PFH  
(x4) | 8 x 1/2



**H100088** | VIS TÊTE PLATE CRUCIFORME PFH  
(x305) | 8 x 1 1/8

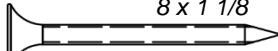

**H100086** | VIS TÊTE PLATE CRUCIFORME PFH  
(x282) | 8 x 1 1/2

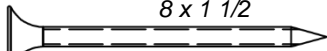

**H100089** | VIS TÊTE PLATE CRUCIFORME PFH  
(x65) | 8 x 1 3/4

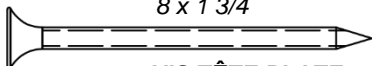

**H100111** | VIS TÊTE PLATE CRUCIFORME PFH  
(x7) | 8 x 2

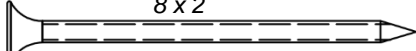

**H100091** | VIS TÊTE PLATE CRUCIFORME PFH  
(x26) | 8 x 2 1/4

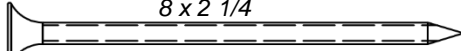

**H100090** | VIS TÊTE PLATE CRUCIFORME PFH  
(x73) | 8 x 2 1/2 po

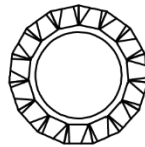

**H100031** | RONDELLE DE VERROUILLAGE EXT  
(x12) | 12 x 19

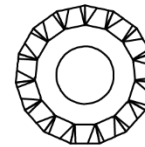

**H100030** | RONDELLE DE VERROUILLAGE EXT  
(x155) | 8 x 19

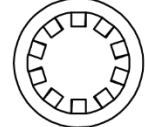

**H100107** | RONDELLE DE VERROUILLAGE INT  
(x13) | 10 x 18

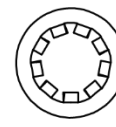

**H100108** | RONDELLE DE VERROUILLAGE INT  
(x26) | 8 x 15

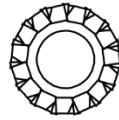

**H100138** | RONDELLE DE VERROUILLAGE EXT  
(x9) | 6 x 15

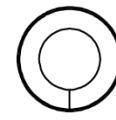

**H100095** | RONDELLE FENDUE  
(x4) | 5/16

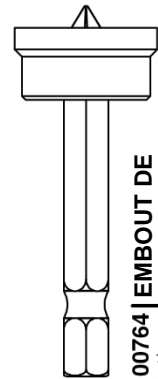

**H100764** | EMBOUT DE VISSAGE  
(x1)



**H101100** | TOURNEVIS MAGNÉTIQUE  
(x1)

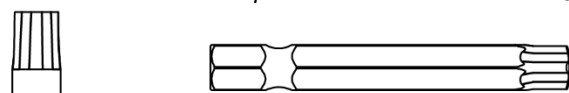

**A100042** | DOUILLE TORX  
(x2) | T-40

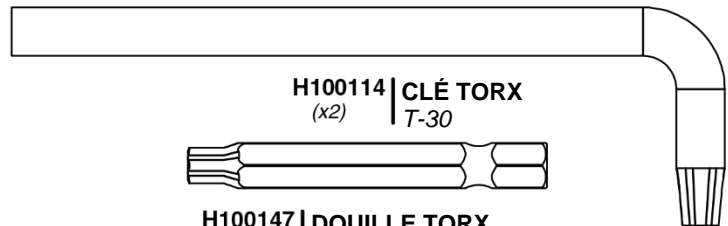

**H100114** | CLÉ TORX  
(x2) | T-30

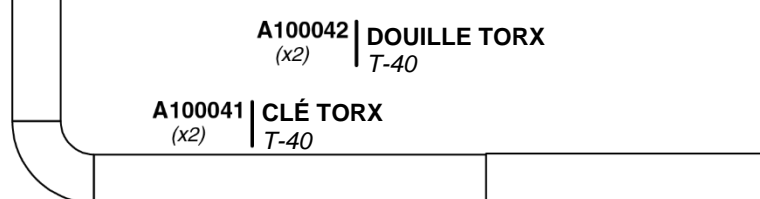

**A100041** | CLÉ TORX  
(x2) | T-40

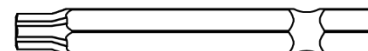

**H100147** | DOUILLE TORX  
(x2) | T-30

# Manuel du propriétaire - Identification des pièces

## Composants accessoires (pas à l'échelle)



A100035 | LIT DE TOBOGGAN DE 2,4 M (10 PI) VERT CLAIR  
(x1)

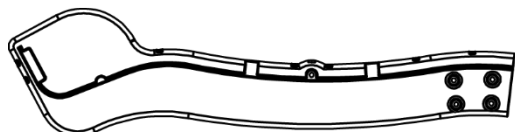

A6P00484 | GLISSIÈRE DE TOBOGGAN DE  
(x1) 3,05 M (10 PI) VERTE  
INFÉRIEURE DROITE



A6P00486 | GLISSIÈRE DE TOBOGGAN  
(x1) DE 3,05 M (10 PI) VERTE  
SUPÉRIEURE DROITE



A6P00483 | GLISSIÈRE DE TOBOGGAN  
(x1) DE 3,05 M (10 PI) VERTE  
INFÉRIEURE GAUCHE

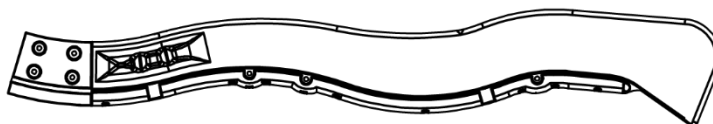

A6P00485 | GLISSIÈRE DE TOBOGGAN  
(x1) DE 3,05 M (10 PI) VERTE  
SUPÉRIEUR GAUCHE



A6P00487 | SUPPORT DES TUBES DU TOBOGGAN  
(x4)

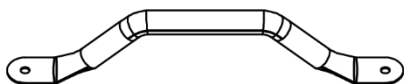

A100118 | POIGNÉE VERT  
(x4) MÉTALLIQUE  
381 c/c

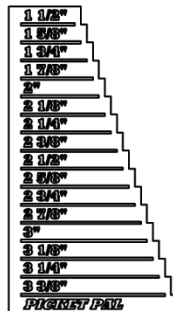

A6P00410 | PIQUET  
(x1)

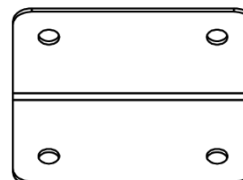

A100140 | SUPPORT EN L  
(x2) 66 x 66 x 127



A4M01046 | SUPPORT EN L  
(x3) 2,5 x 38 x 55 x 55



A100314 | ÉTIQUETTE DE  
(x1) CONTRÔLE « A »

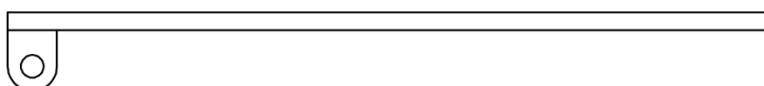

A4M00527 | BARRE DE RENFORT  
(x2) DE PIQUET



A100178 | TARIÈRE  
(x6)

# Manuel du propriétaire - Identification des pièces

## Composants accessoires (pas à l'échelle)

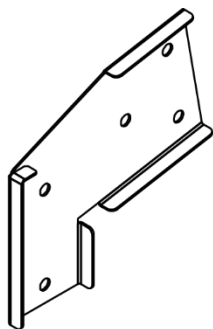

A100325 | SUPPORT D'EXTENSION  
(x1) DE POUTRE DE  
BALANÇOIRE - GAUCHE

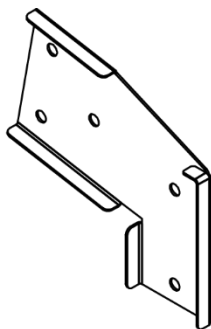

A100326 | SUPPORT D'EXTENSION  
(x1) DE POUTRE DE  
BALANÇOIRE - DROITE

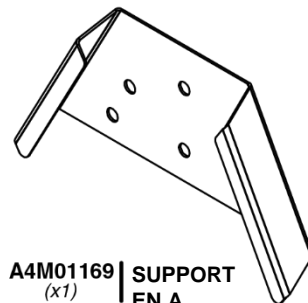

A4M01169 | SUPPORT  
(x1) EN A

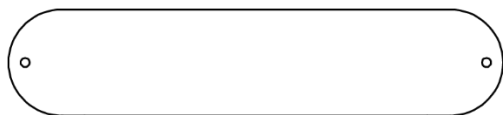

A100027 | SIÈGE DE BALANÇOIRE  
(x2) VERT 26 PO [660,4 MM]

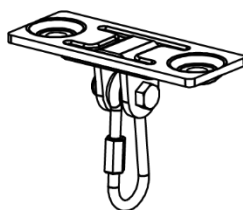

A4M00505 | CROCHET DE BALANÇOIRE  
(x6)

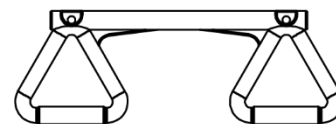

A6P00034 | TRAPÈZE  
(x1) JAUNE



A100183 | CORDE - CHAÎNE VERTE 57 PO (144,78 CM)  
(x4)

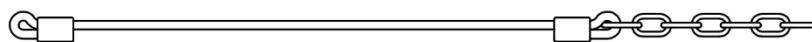

A100083 | CORDE - CHAÎNE VERTE 33 PO (83,82 CM)  
(x2)



A6P00036 | PRISE HC VERTE No 1  
(x6)

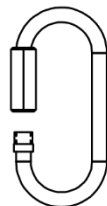

A100069 | MAILLON RAPIDE  
(x6)

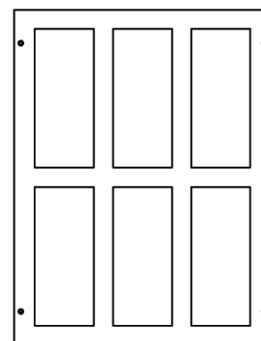

A100010 | FENÊTRE PLASTIQUE BYD VERT 343x444.5  
(x2)



A6P00037 | PRISE HC VERTE No 2  
(x6)



A100164 | ÉTIQUETTE D'IDENTIFICATION  
(x1) DE BYD

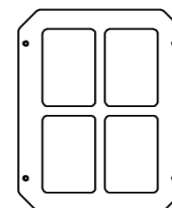

A100146 | FENÊTRE  
(x3) 216 x 267 VERT

# ÉTAPE 1 DE PRÉ-ASSEMBLAGE - TRI DES PIÈCES

Il est essentiel pour faciliter l'assemblage que vous preniez le temps de trier et d'organiser le bois et la quincaillerie.

## PIÈCES EN BOIS :

- Organisez les pièces de bois selon le numéro alphanumérique à trois chiffres estampillé sur chaque planche (ex. P01).
- S'il y a plusieurs planches avec le même numéro estampillé, empilez ces pièces ensemble.
- Les tampons se trouvent sur la surface plane ou sur l'extrémité des planches.
- Prévoyez beaucoup d'espace - les pièces de bois peuvent prendre beaucoup de place.

**REMARQUE : LES CARTONS NE SONT PAS ORGANISÉS PAR NUMÉRO DE PLANCHE.**

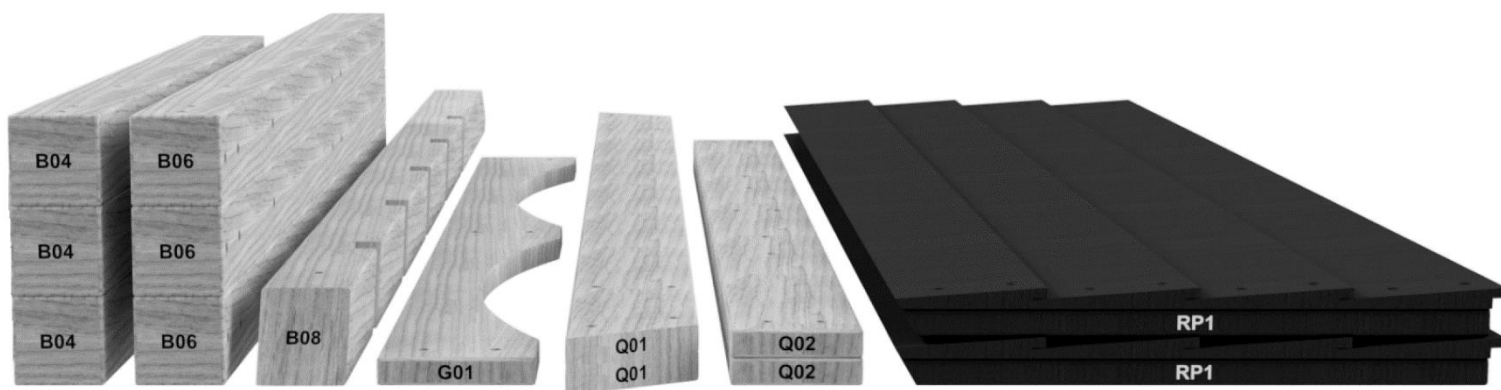

## PIÈCES DE QUINCAILLERIE :

- Nous vous recommandons d'avoir une table séparée pour organiser les pièces de quincaillerie.
- Les sacs de pièces de quincaillerie comportent un numéro de pièce alphanumérique à sept chiffres.
- Vous pouvez organiser vos pièces de quincaillerie par numéro de pièce ou les grouper par type de pièce (c.-à-d. boulons, écrous, etc.).
- Lors de l'assemblage, il vous suffit de référencer les quatre derniers chiffres du numéro.

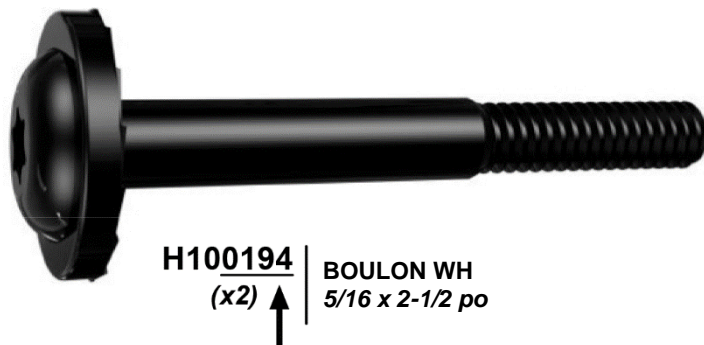

## ÉTAPE 2 DE PRÉ-ASSEMBLAGE - OUTILS NÉCESSAIRES



*Perceuse sans fil ou perceuse électrique*



*Accessoires de la perceuse :  
Tête cruciforme*



*Mèches de 1/8 po,  
3/16 po, 3/8 po et 7/16 po*



*Tournevis cruciforme*



*Clés ouvertes de 1/2 po et 9/16 po*

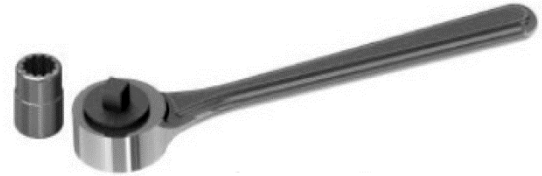

*Clé à cliquet de 3/8 po, douilles  
standard de 1/2 po et 9/16 po, douilles  
profondes de 1/2 po et 7/16 po*



*Marteau à panne fendue*

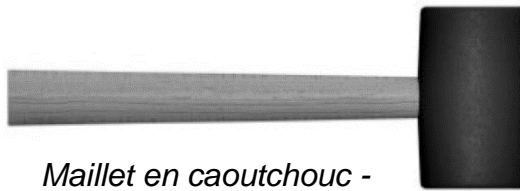

*Maillet en caoutchouc -  
En option*

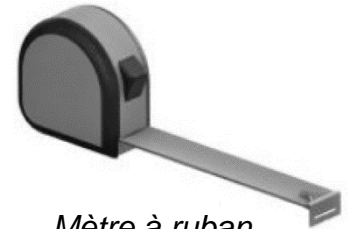

*Mètre à ruban*

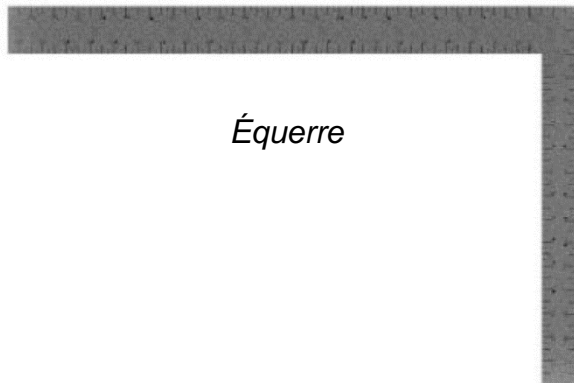

*Équerre*

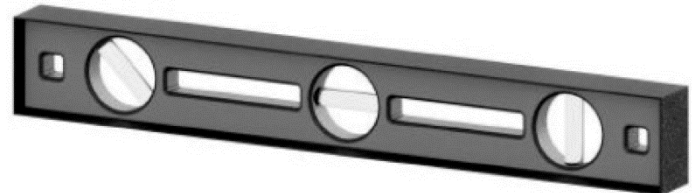

*Niveau de 24 po*

## ÉTAPE 3 DE PRÉ-ASSEMBLAGE - CHOISISSEZ VOTRE MÉTHODE D'ASSEMBLAGE

Plusieurs types d'instructions de montage s'offrent à vous.

1. Manuel d'assemblage imprimé inclus avec votre produit
2. Application BILT - Instructions interactives en 3D
3. Combinaison du manuel imprimé et de l'application BILT (Remarque : Les numéros d'étape peuvent différer entre les deux méthodes)



**Scannez pour des instructions 3D faciles**

Téléchargez l'application BILT avant de commencer



# ÉTAPE 1 - ÉCHELLE

QTÉ	NUMÉRO D'ARTICLE	DESCRIPTION
8	H100091	VIS TÊTE PLATE PFH 8 x 2 1/4

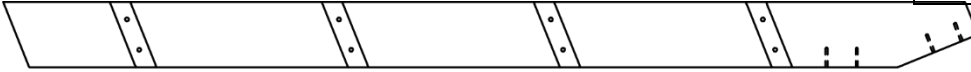

**E74** | MONTANT GAUCHE - W4L16028  
(x1) 1 3/8 po x 3 3/8 po x 50 3/4 po (36 x 86 x 1290)



**H07** | ÉCHELON - W4L16030  
(x4) 15/16 po x 3 3/8 po x 18 7/8 po (24 x 86 x 480)

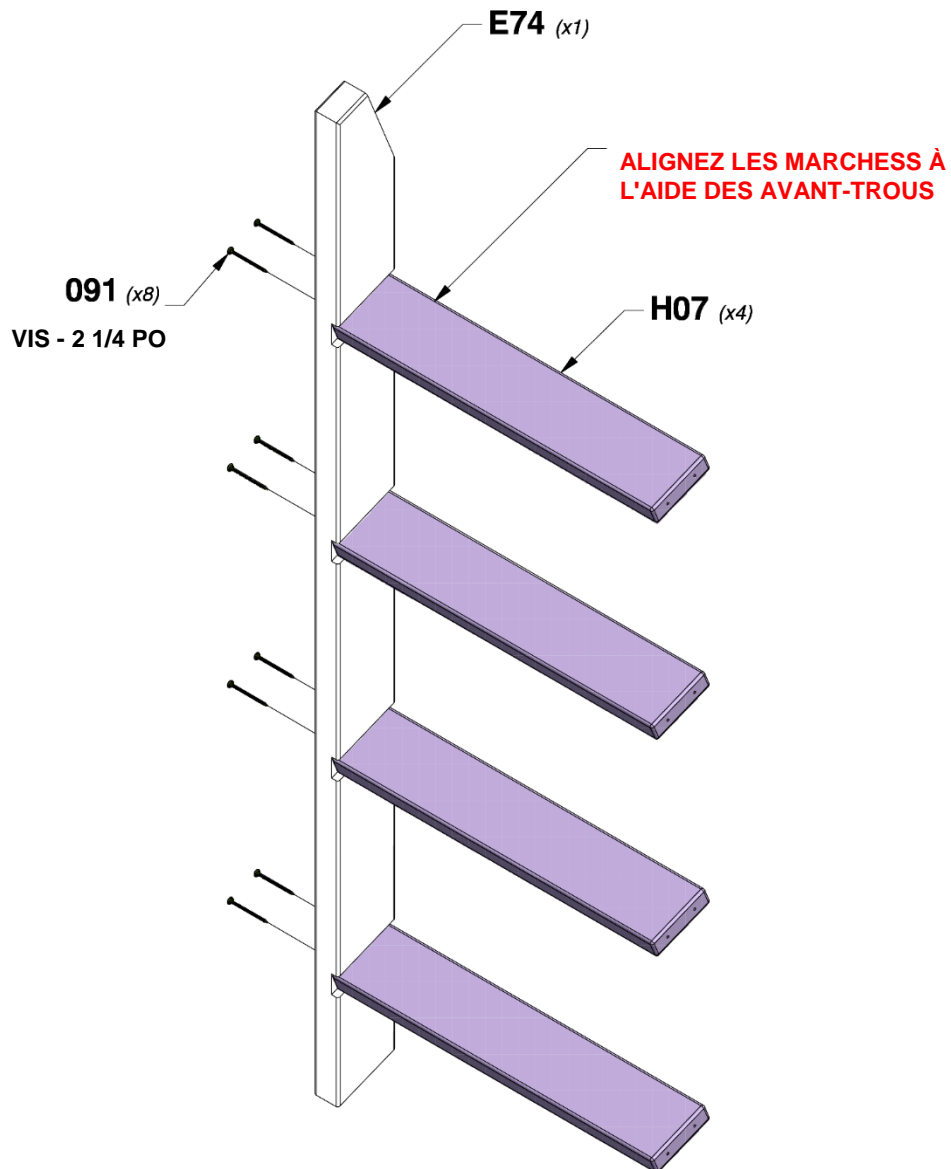

## ÉTAPE 2 - ÉCHELLE

QTÉ	NUMÉRO D'ARTICLE	DESCRIPTION
8	H100091	VIS TÊTE PLATE PFH 8 x 2 1/4



**E75** MONTANT DROIT - W4L16029  
(x1) 1 3/8 po x 3 3/8 po x 50 3/4 po (36 x 86 x 1290)

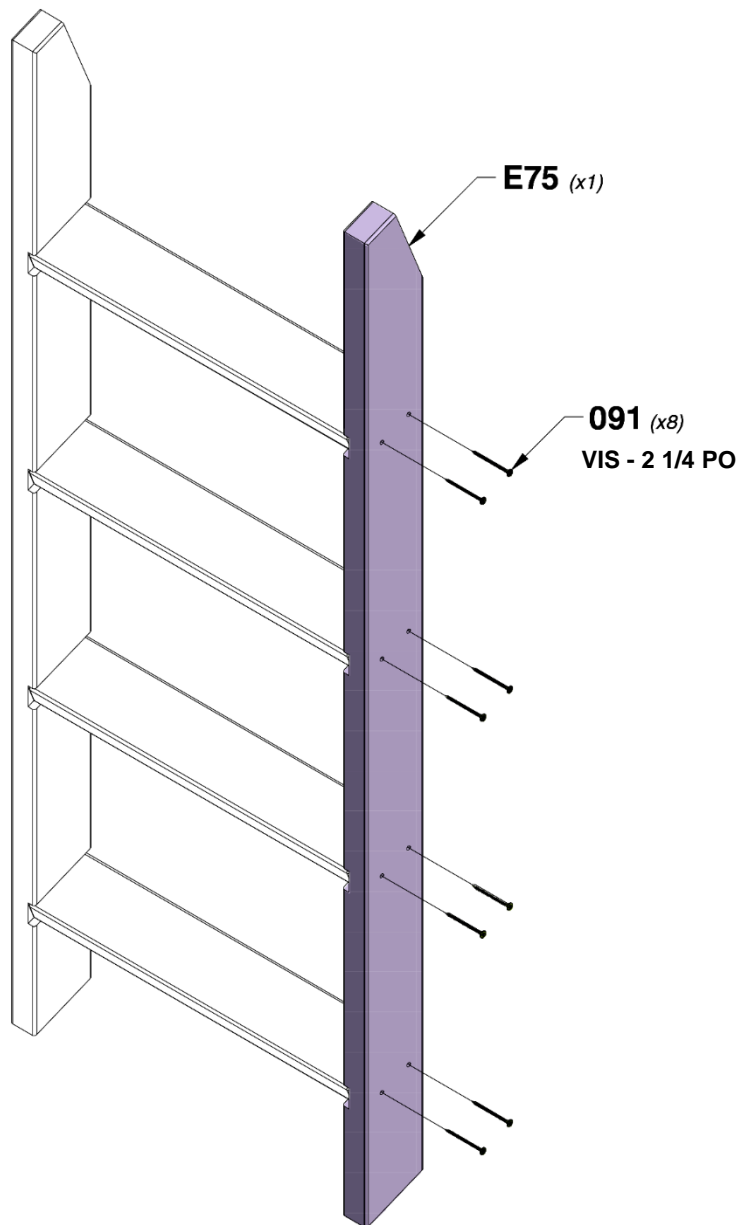

# ÉTAPE 3 - ÉCHELLE

QTÉ	NUMÉRO D'ARTICLE	DESCRIPTION
4	H100091	VIS TÊTE PLATE PFH 8 x 2 1/4



**M73** | **SUPPORT ARRIÈRE - W4L16070**  
*(x1)* 5/8 po x 3 3/8 po x 21 po (16 x 86 x 532)

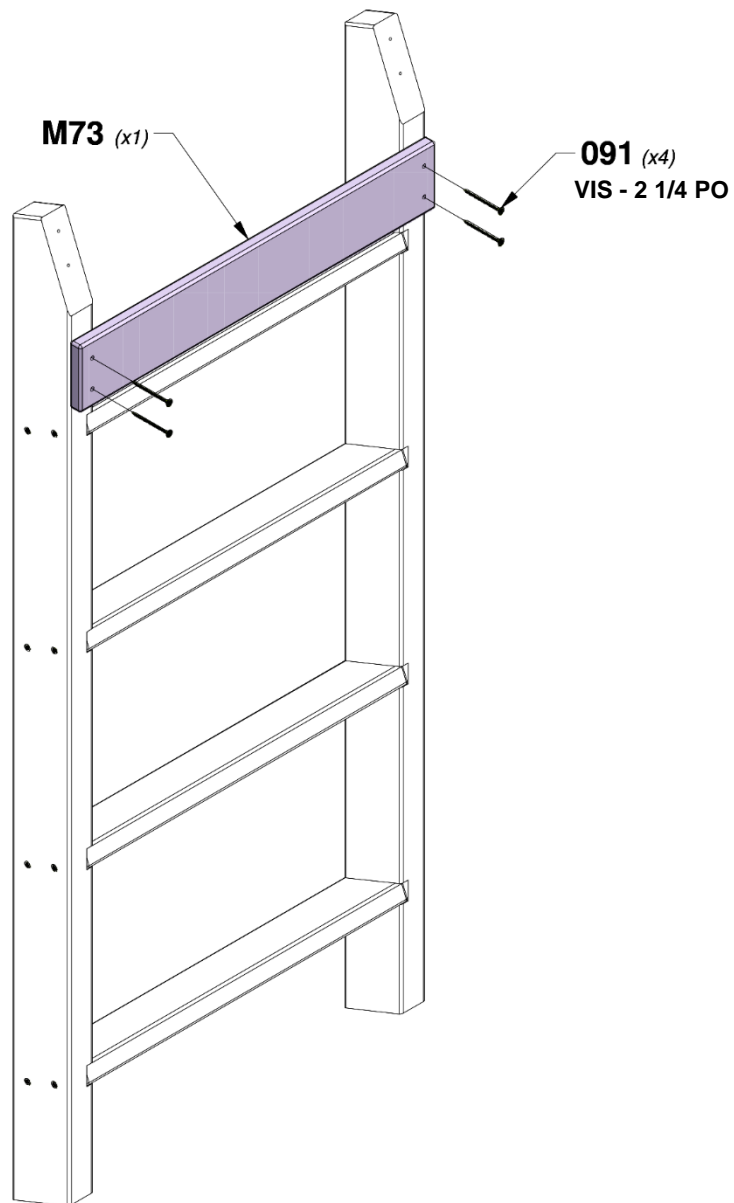

# ÉTAPE 4 - ÉCHELLE

QTÉ	NUMÉRO D'ARTICLE	DESCRIPTION
4	H100091	VIS TÊTE PLATE PFH 8 x 2 1/4



**H06** | PLANCHE SUPÉRIEURE DE L'ÉCHELLE - W4L16088  
(x1) | 1 po x 3 3/8 po x 21 po (24 x 86 x 532)

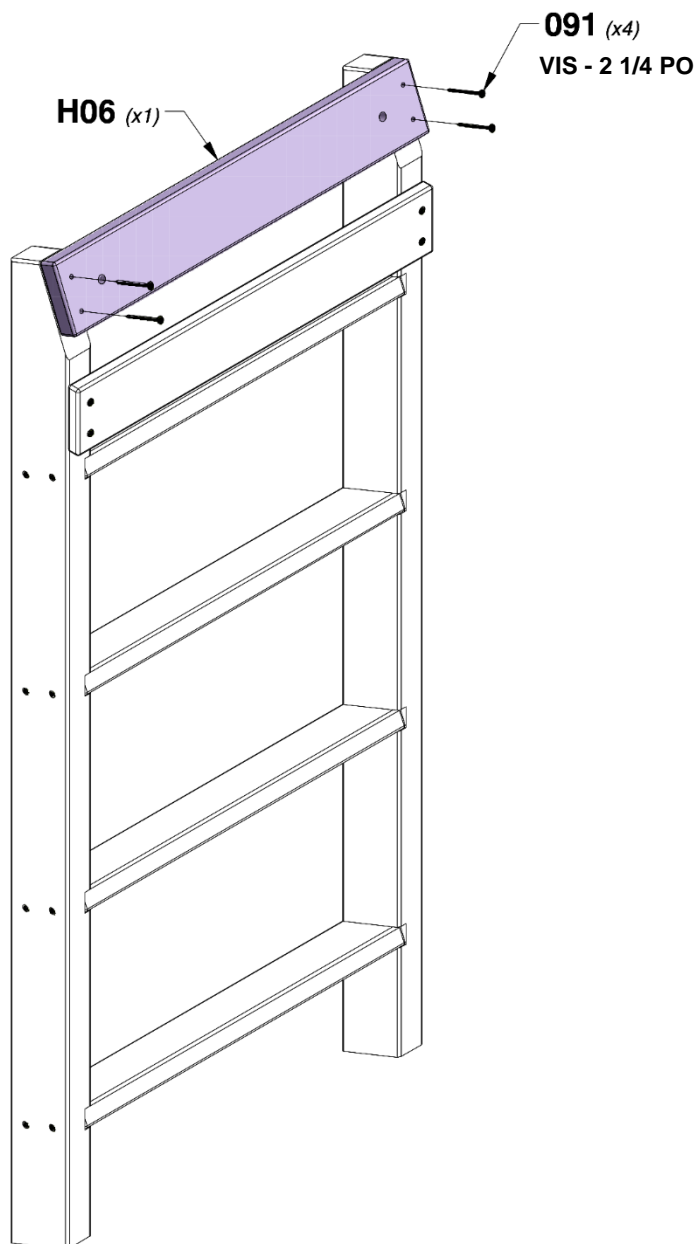

# ÉTAPE 1 - MUR D'ESCALADE

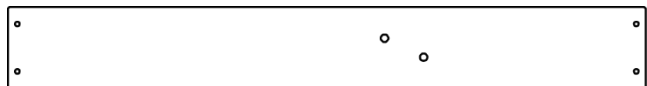

**M75** | PLANCHE DE MUR D'ESCALADE - W4L16072  
(x4) 5/8 po x 3 3/8 po x 26 5/8 po (16 x 86 x 675)

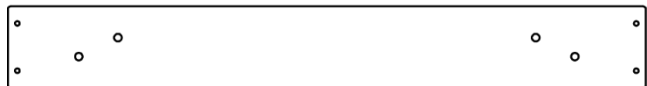

**M76** | PLANCHE DE MUR D'ESCALADE - W4L16073  
(x4) 5/8 po x 3 3/8 po x 26 5/8 po (16 x 86 x 675)

QTÉ	NUMÉRO D'ARTICLE	DESCRIPTION
24	H100063	BOULON PTH 1/4 x 3/4
24	H100072	ÉCROU À ENFONCER 1/4
24	H100106	RONDELLE DE VERROUILLAGE INT 8 x 15



**CONSEIL :**  
INSTALLER D'ABORD DES ÉCROUS A ENFONCER DANS LE BOIS

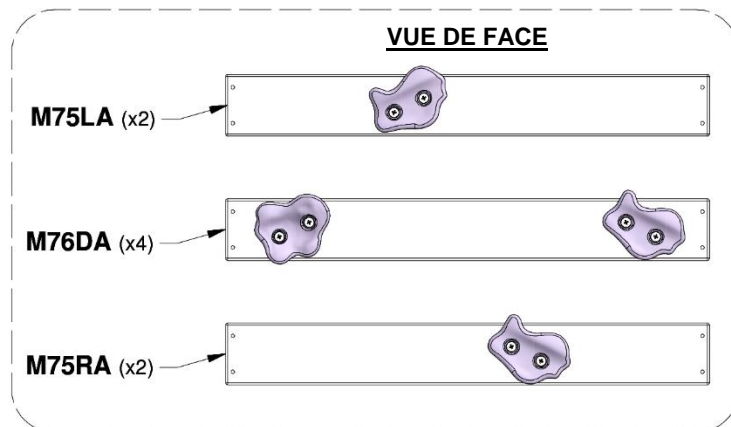
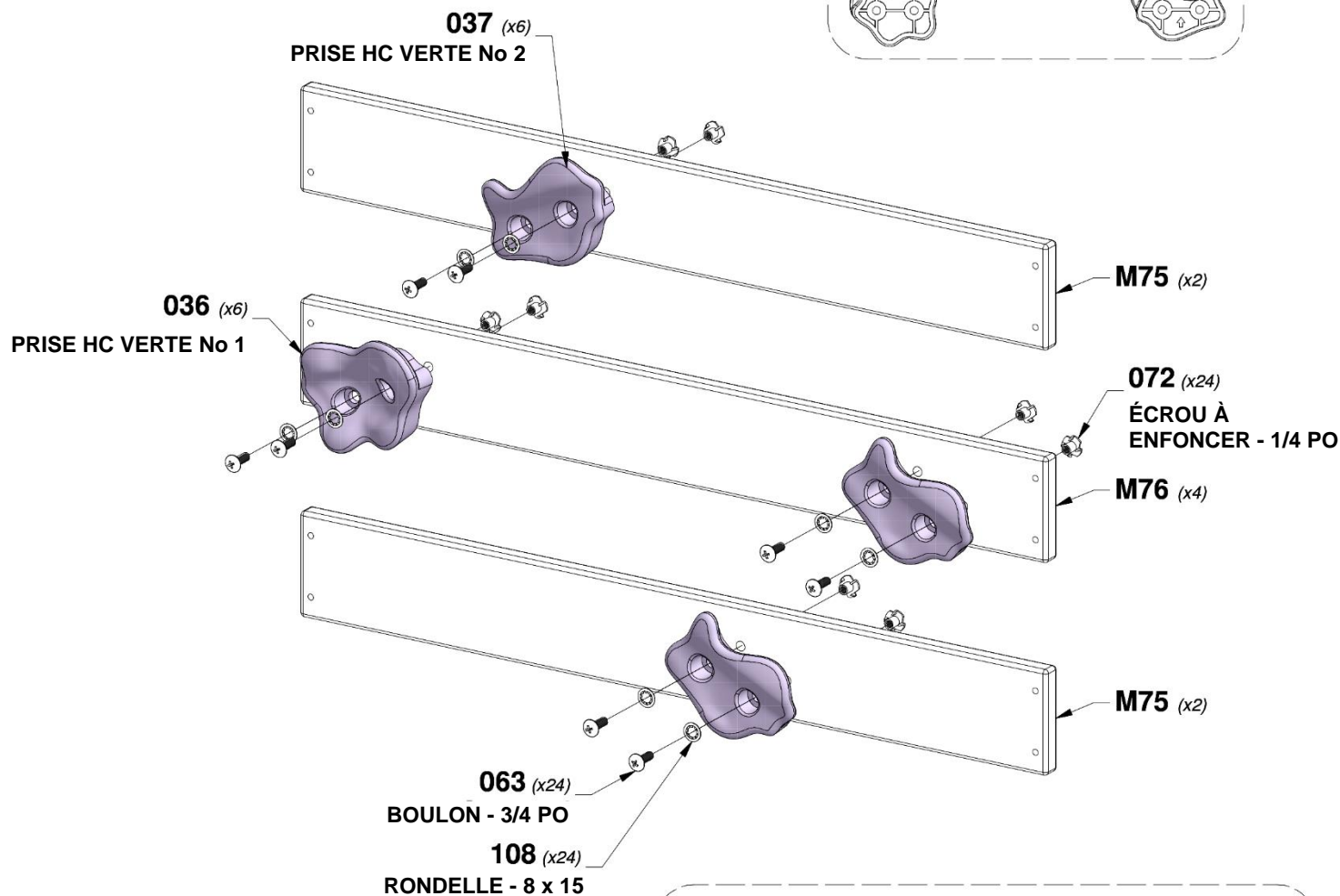

# ÉTAPE 2 - MUR D'ESCALADE

QTÉ	NUMÉRO D'ARTICLE	DESCRIPTION
76	H100086	VIS TÊTE PLATE PFH 8 x 1-1/2 PO

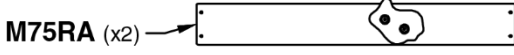
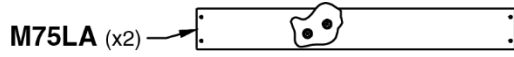

**E72** RAIL GAUCHE - W4L16007  
(x1) 1 3/8 po x 3 3/8 po x 64 1/2 po (36 x 86 x 1640)

**E73** RAIL DROIT - W4L16008  
(x1) 1 3/8 po x 3 3/8 po x 64 1/2 po (36 x 86 x 1640)

**M74** PLANCHE DE MUR D'ESCALADE -  
(x1) W4L16071 5/8 po x 3 3/8 po x 26 5/8 po  
(16 x 86 x 675)

**N06** PLANCHE DE REMPLISSAGE -  
(x1) W4L16089 5/8 po x 2 1/8 po x 26  
5/8 po (16 x 54 x 675)

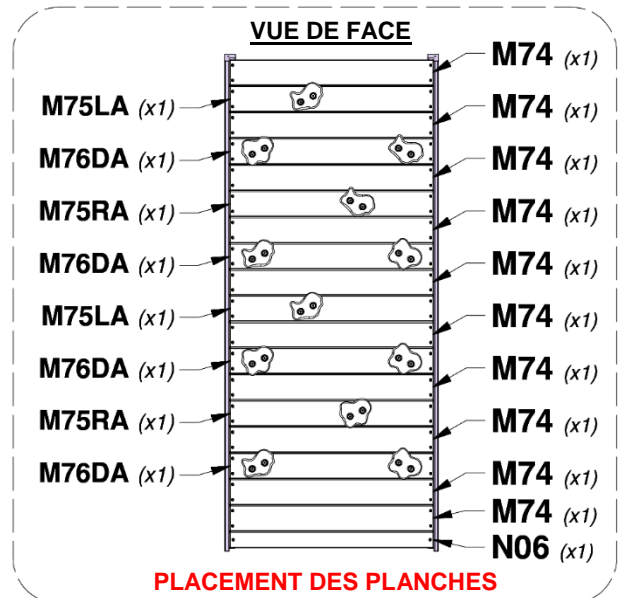
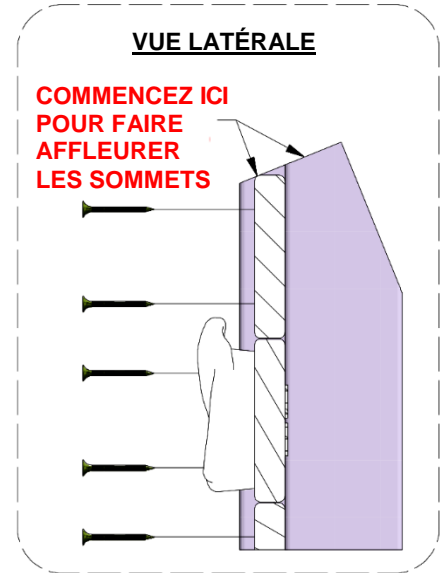
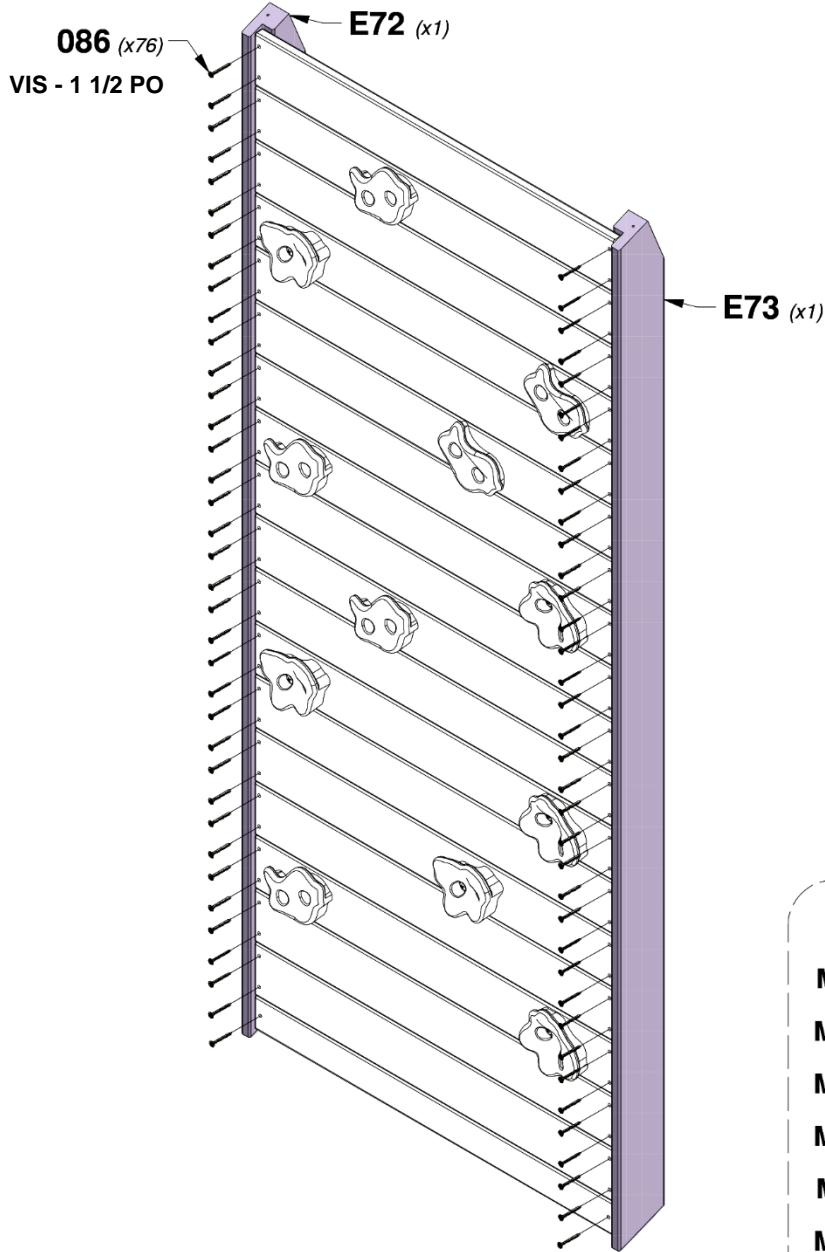

# ÉTAPE 3 - MUR D'ESCALADE

QTÉ	NUMÉRO D'ARTICLE	DESCRIPTION
2	H100086	VIS TÊTE PLATE PFH 8 x 1-1/2 PO



**M108** | **PLANCHE SUPÉRIEURE - W4L16046**  
(x1) | 5/8 po x 3 1/4 po x 27 7/8 po (16 x 82 x 707)

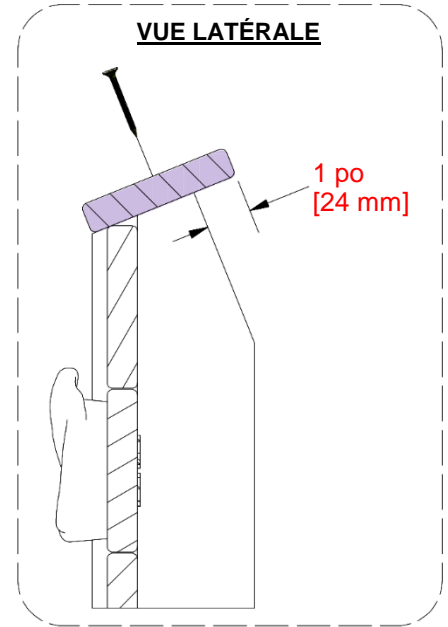
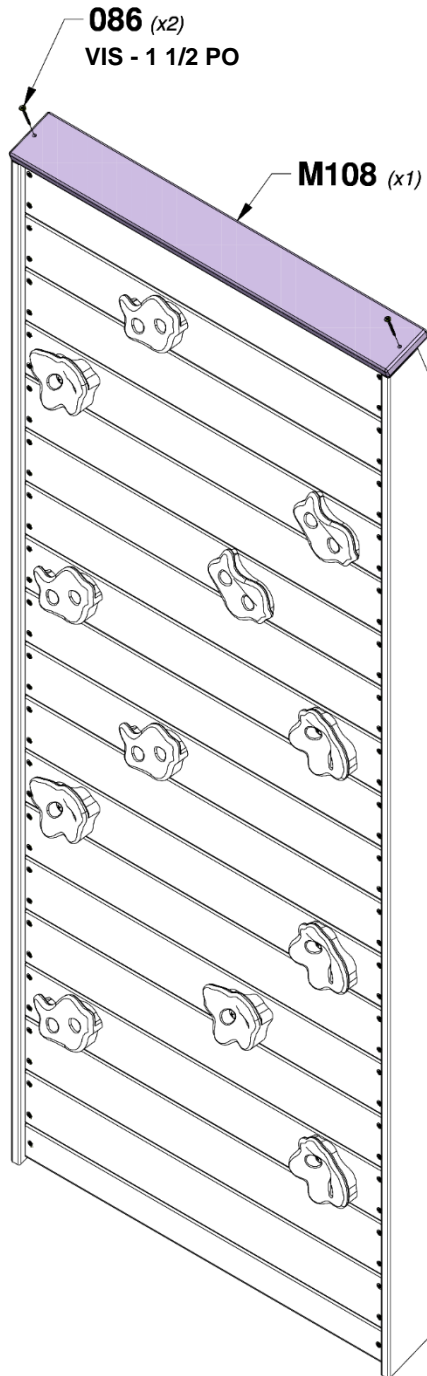

# ÉTAPE 4 - MUR D'ESCALADE



**H10** | **PLANCHE DE FIXATION - W4L16045**  
 (x1) | 1 po x 3 3/8 po x 27 7/8 po (24 x 86 x 707)

QTÉ	NUMÉRO D'ARTICLE	DESCRIPTION
2	H100074	ÉCROU À ENFONCER 5/16
4	H100111	VIS TÊTE PLATE PFH 8 x 2 PO

**CONSEIL :**  
**INSTALLEZ D'ABORD DES ÉCROUS A ENFONCER DANS LE BOIS**

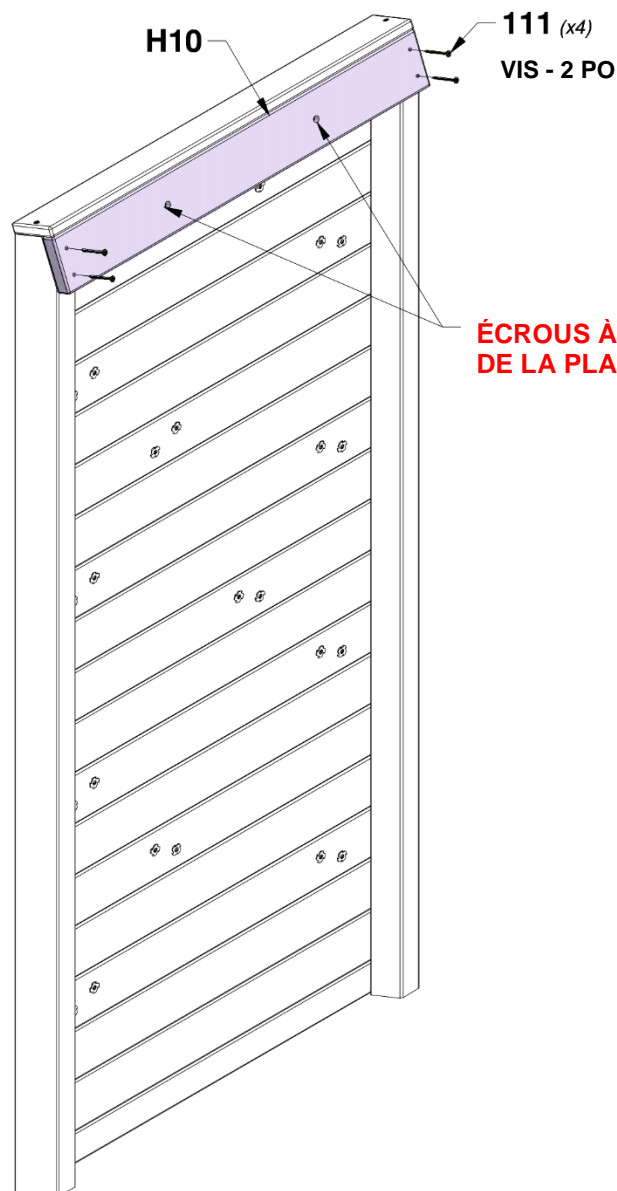
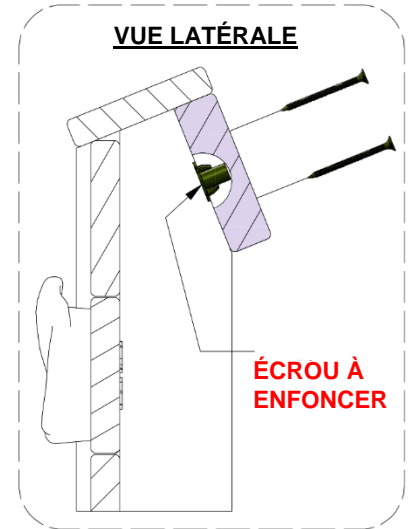
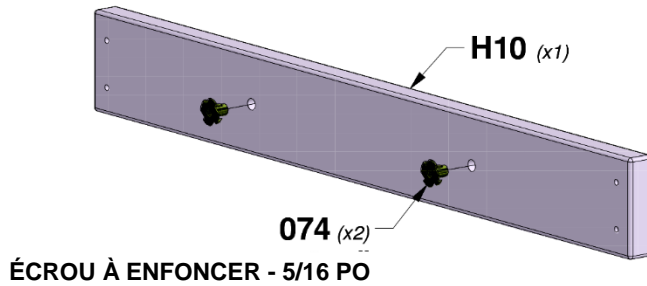

**ÉCROUS À ENFONCER À L'INTÉRIEUR DE LA PLANCHE LORSQU'INSTALLÉS**

# ÉTAPE 1 - POUTRE DE BALANÇOIRE



**A50** | POUTRE DE LA BALANÇOIRE - W4L15998  
(x1) 3 3/8 po x 5 1/4 po x 89 1/2 po (86 x 134 x 2274)

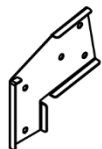

**A100325** | SUPPORT D'EXTENSION DE POUTRE DE BALANÇOIRE - GAUCHE  
(x1)



**A100326** | SUPPORT D'EXTENSION DE POUTRE DE BALANÇOIRE - DROITE  
(x1)



**A100140** | SUPPORT EN L  
(x2) 66 x 66 x 127

QTÉ	NUMÉRO D'ARTICLE	DESCRIPTION
3	H100005	ÉCROU À PORTÉE CYLINDRIQUE WH 5/16 x 7/8
3	H100016	BOULON WH 5/16 x 3
2	H100054	BOULON HEX 5/16 x 4 1/4
4	H100105	RONDELLE PLATE 8 x 27
2	H100110	ÉCROU AUTOBLOQUANT - 5/16

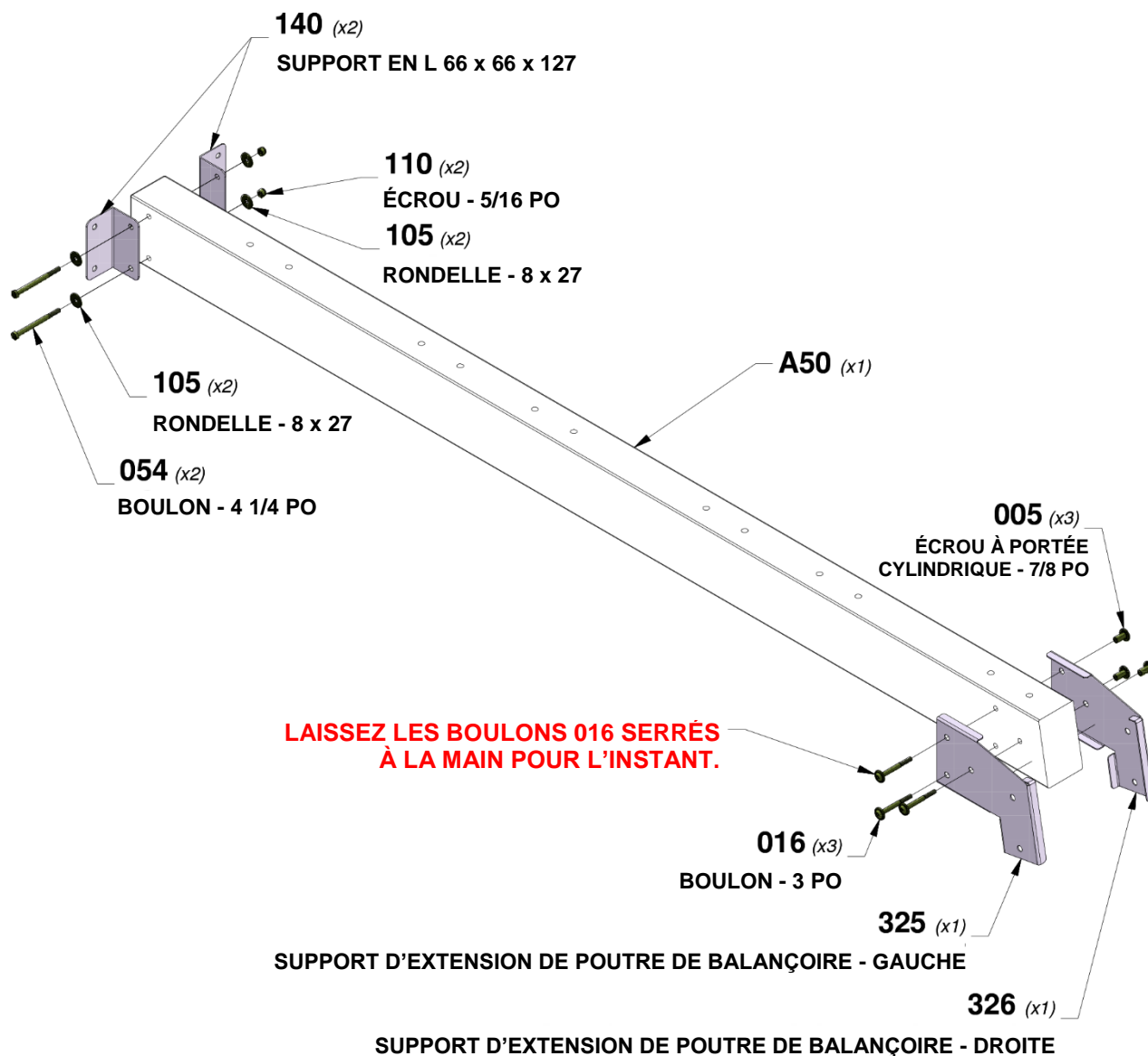

# ÉTAPE 2 - POUTRE DE BALANÇOIRE

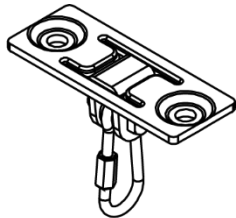

**A4M00505**  
(x4) | CROCHET DE BALANÇOIRE

QTÉ	NUMÉRO D'ARTICLE	DESCRIPTION
12	H100073	ÉCROU À ENFONCER 3/8 PO
12	H100102	RONDELLE PLATE 11 x 25
12	H100107	RONDELLE DE SÉCURITÉ INT 10 x 18
12	H100654	BOULON HEX 3/8 x 5-1/2

**CONSEIL :**  
**INSTALLEZ D'ABORD DES ÉCROUS A ENFONCER DANS LE BOIS**

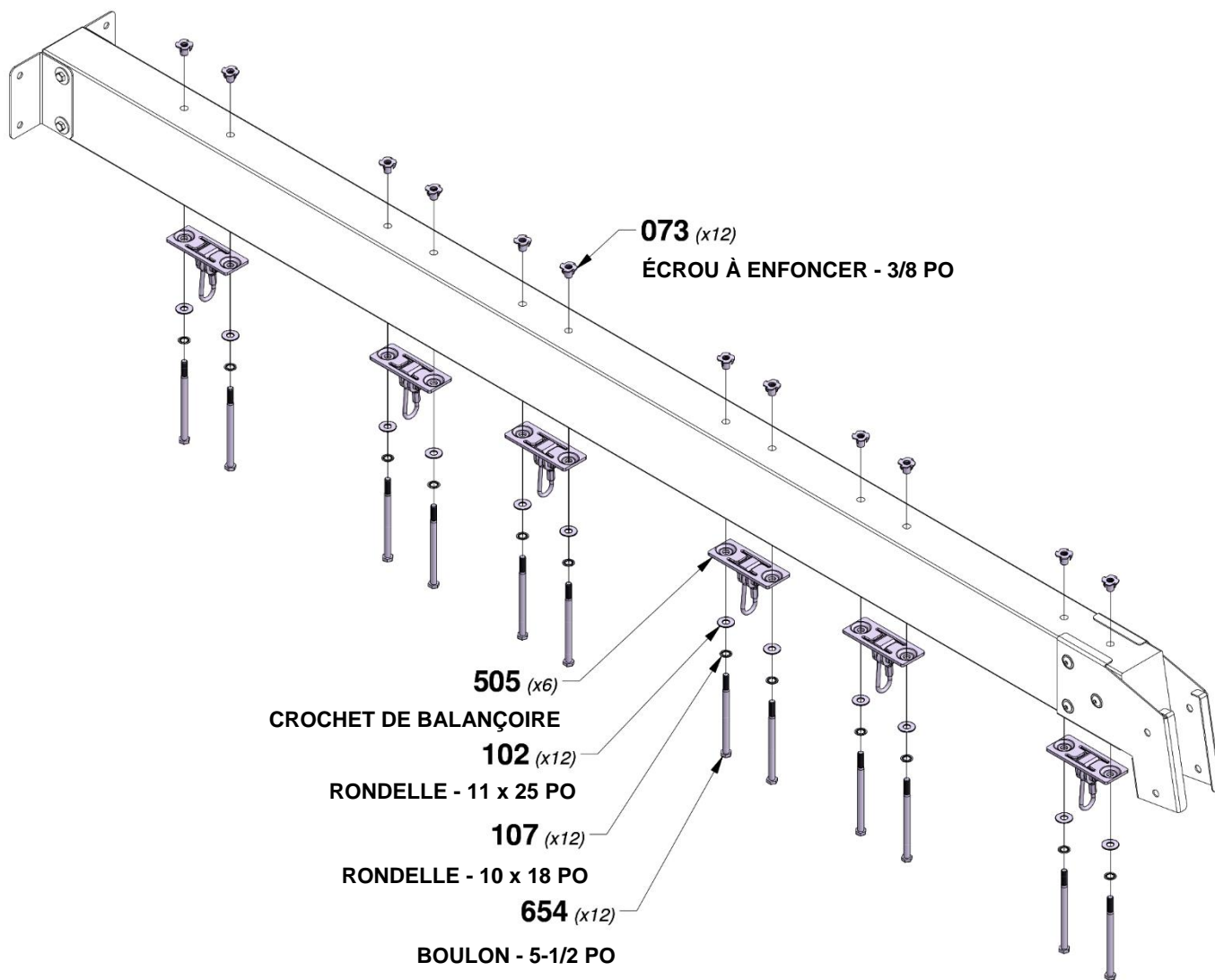

# ÉTAPE 3 - POUTRE DE BALANÇOIRE



A100164 | ÉTIQUETTE D'IDENTIFICATION  
(x1) DE BYD (GRANDE) 3 À 10 ANS

QTÉ	NUMÉRO D'ARTICLE	DESCRIPTION
4	H100124	VIS TÊTE PLATE PFH 8 x 1/2 PO

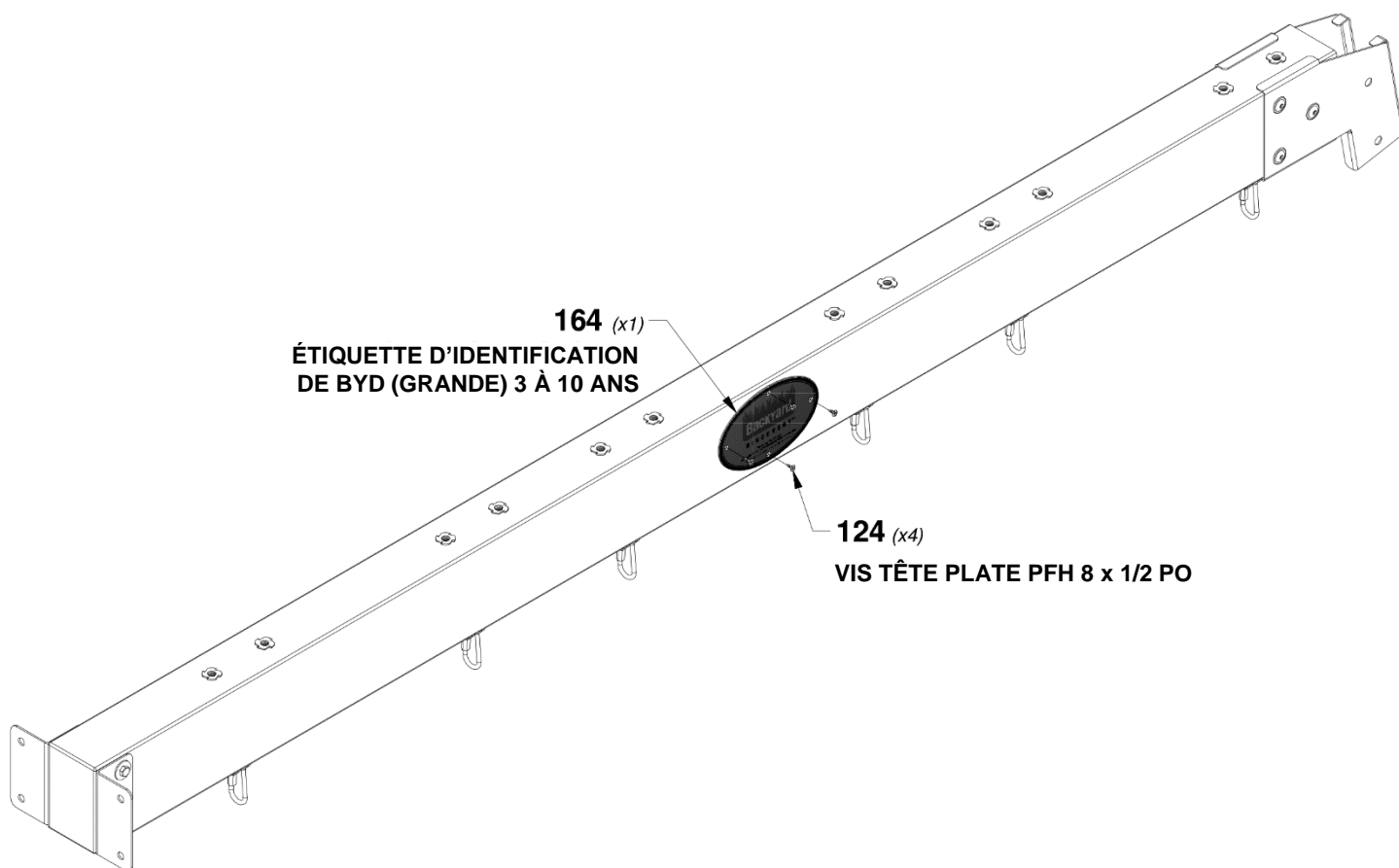

# ÉTAPE 4 - POUTRE DE BALANÇOIRE

QTÉ	NUMÉRO D'ARTICLE	DESCRIPTION
4	H100009	BOULON WH 5/16 x 1 1/4
2	H100018	BOULON WH 5/16 x 3 1/2
6	H100074	ÉCROU À ENFONCER 5/16



**SP50** | SUPPORT DE POUTRE DE BALANÇOIRE - W4L16085  
(x1) 3 3/8 po x 3 3/8 po x 49 3/8 po (86 x 86 x 1254)

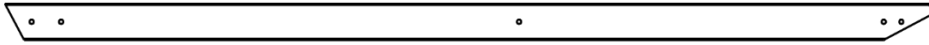

**E51** | CALE ANGULAIRE - W4L16004  
(x2) 1 7/16 po x 3 3/8 po x 87 3/16 po (36 x 86 x 2214)

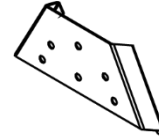

**A4M01169** | SUPPORT EN A  
(x1)

**CONSEIL :**  
**INSTALLEZ D'ABORD DES ÉCROUS**  
**A ENFONCER DANS LE BOIS**

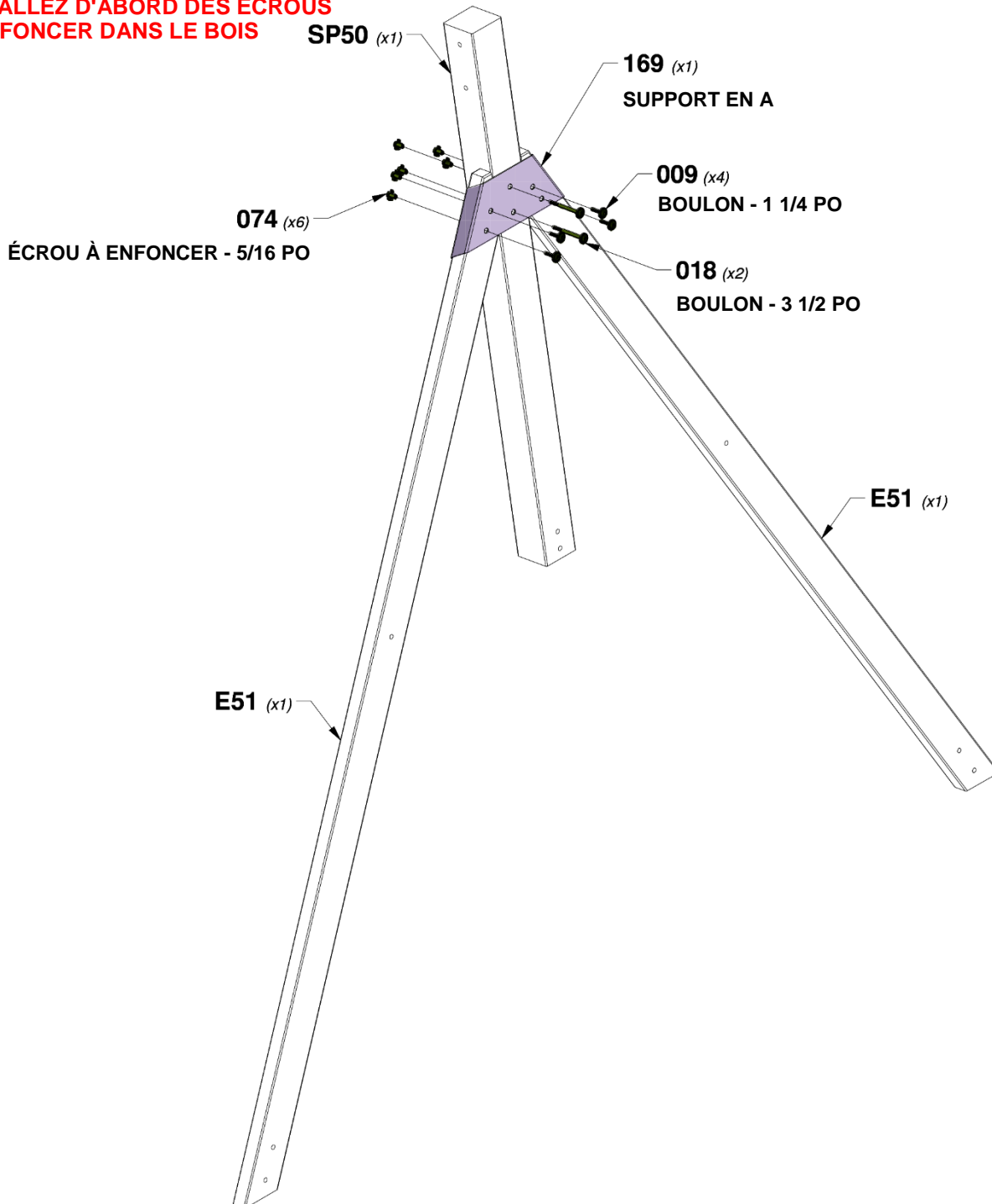

# ÉTAPE 5 - POUTRE DE BALANÇOIRE

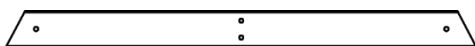

**E50** | SUPPORT D'EXTRÉMITÉ - W4L16003  
(x1) 1 3/8 po x 3 3/8 po x 44 1/8 po (36 x 86 x 1120)

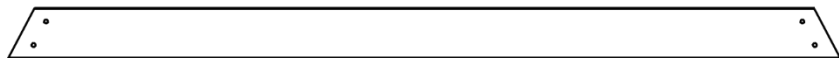

**G14** | PLANCHE DE SOL - W4L16019  
(x1) 15/16 po x 5 1/4 po x 86 11/16 po (24 x 134 x 2202)

QTÉ	NUMÉRO D'ARTICLE	DESCRIPTION
4	H100013	BOULON WH 5/16 x 2 1/4
2	H100015	BOULON WH 5/16 x 2 3/4
8	H100030	RONDELLE DE VERROUILLAGE EXT 8 x 19
8	H100074	ÉCROU À ENFONCER 5/16
2	H100505	BOULON WH 5/16 x 4 3/4

**CONSEIL :**  
**INSTALLEZ D'ABORD DES ÉCROUS**  
**A ENFONCER DANS LE BOIS**

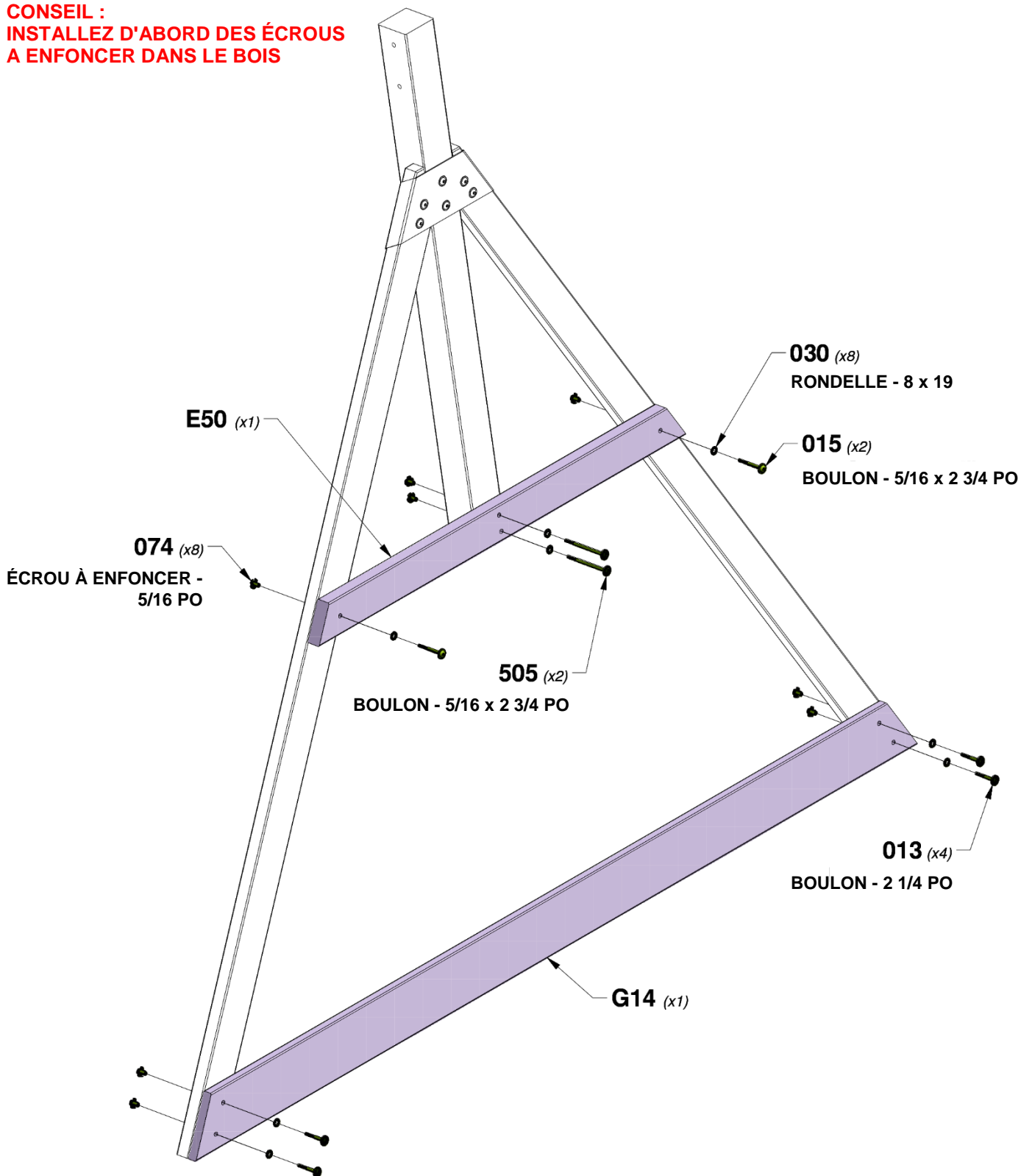

## ÉTAPE 6 - POUTRE DE BALANÇOIRE

QTÉ	NUMÉRO D'ARTICLE	DESCRIPTION
2	H100005	ÉCROU À PORTÉE CYLINDRIQUE WH 5/16 x 7/8
2	H100016	BOULON WH 5/16 x 3

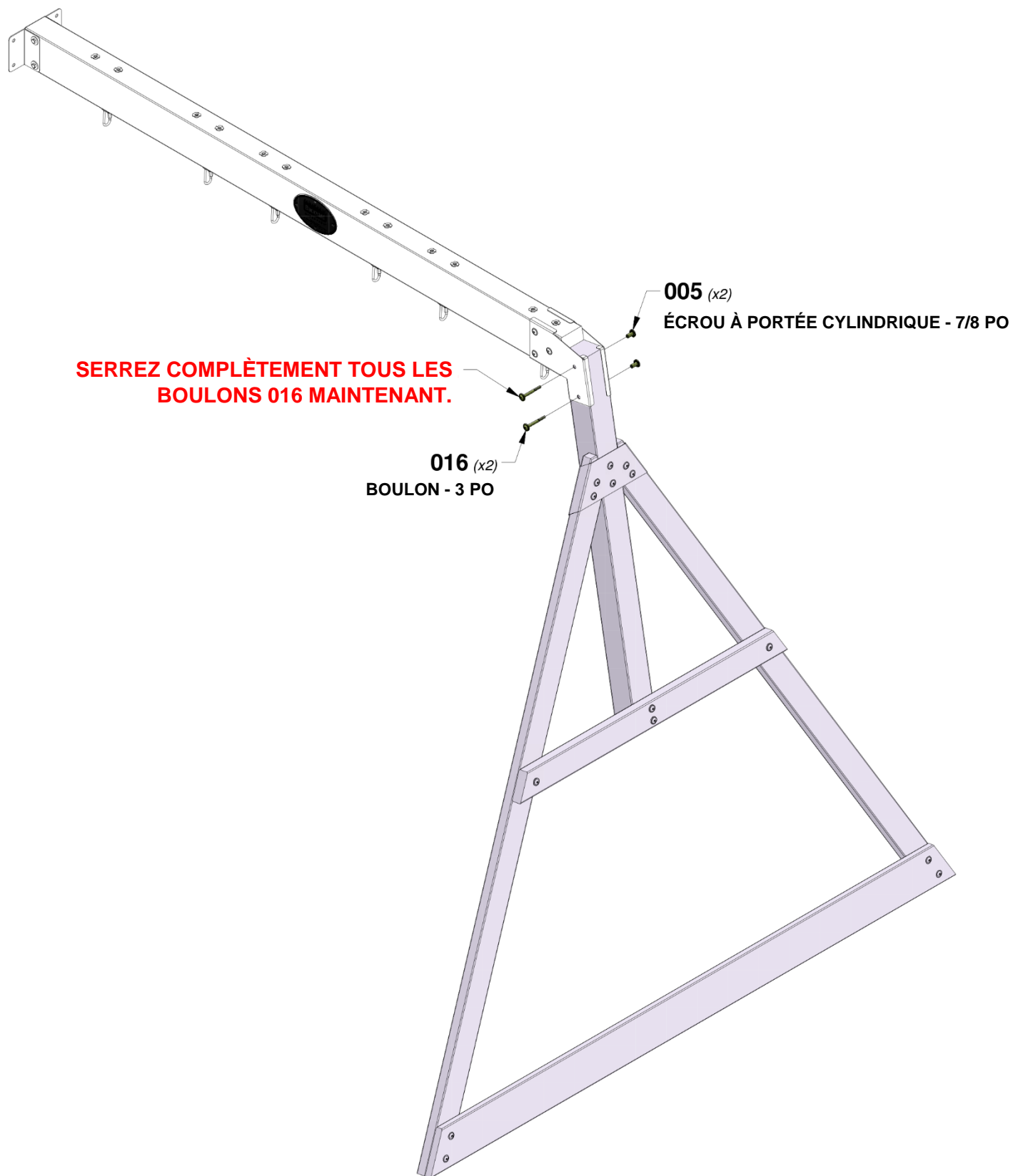



# ÉTAPE 2 - ASSEMBLAGE DU FORT

QTÉ	NUMÉRO D'ARTICLE	DESCRIPTION
20	H100028	VIS TIREFOND WH 5/16 x 2 1/2
20	H100030	RONDELLE DE VERROUILLAGE EXT 8 x 19

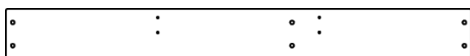

**G04** LISSE DE PLANCHER - W4L16017  
(x1) 5/8 po x 5 1/4 po x 49 po (16 x 134 x 1244)

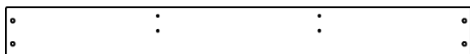

**G07** LISSE DE PLANCHER - W4L16021  
(x2) 1 po x 5 1/4 po x 49 po (24 x 134 x 1244)

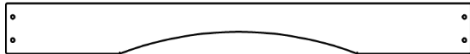

**G08** LISSE MURALE - W4L16022  
(x1) 1 po x 5 1/4 po x 49 po (24 x 134 x 1244)

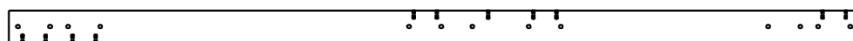

**E02** PIED DE TOUR AVANT CENTRE - W4L16000  
(x1) 1 3/8 po x 3 3/8 po x 89 1/2 po (36 x 86 x 2274)

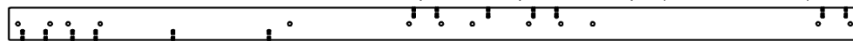

**E06** PIED DE TOUR ARRIÈRE CENTRE - W4L16005  
(x1) 3/8 po x 3 3/8 po x 89 1/2 po (36 x 86 x 2274)

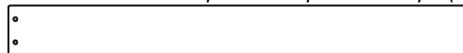

**K02** PANNEAU DE BASE/BAC À SABLE - W4L16035  
(x1) 5/8 po x 5 1/4 po x 49 po (16 x 134 x 1244)

**CONSEIL :**  
INSTALLEZ D'ABORD DES ÉCROUS A ENFONCER DANS LE BOIS

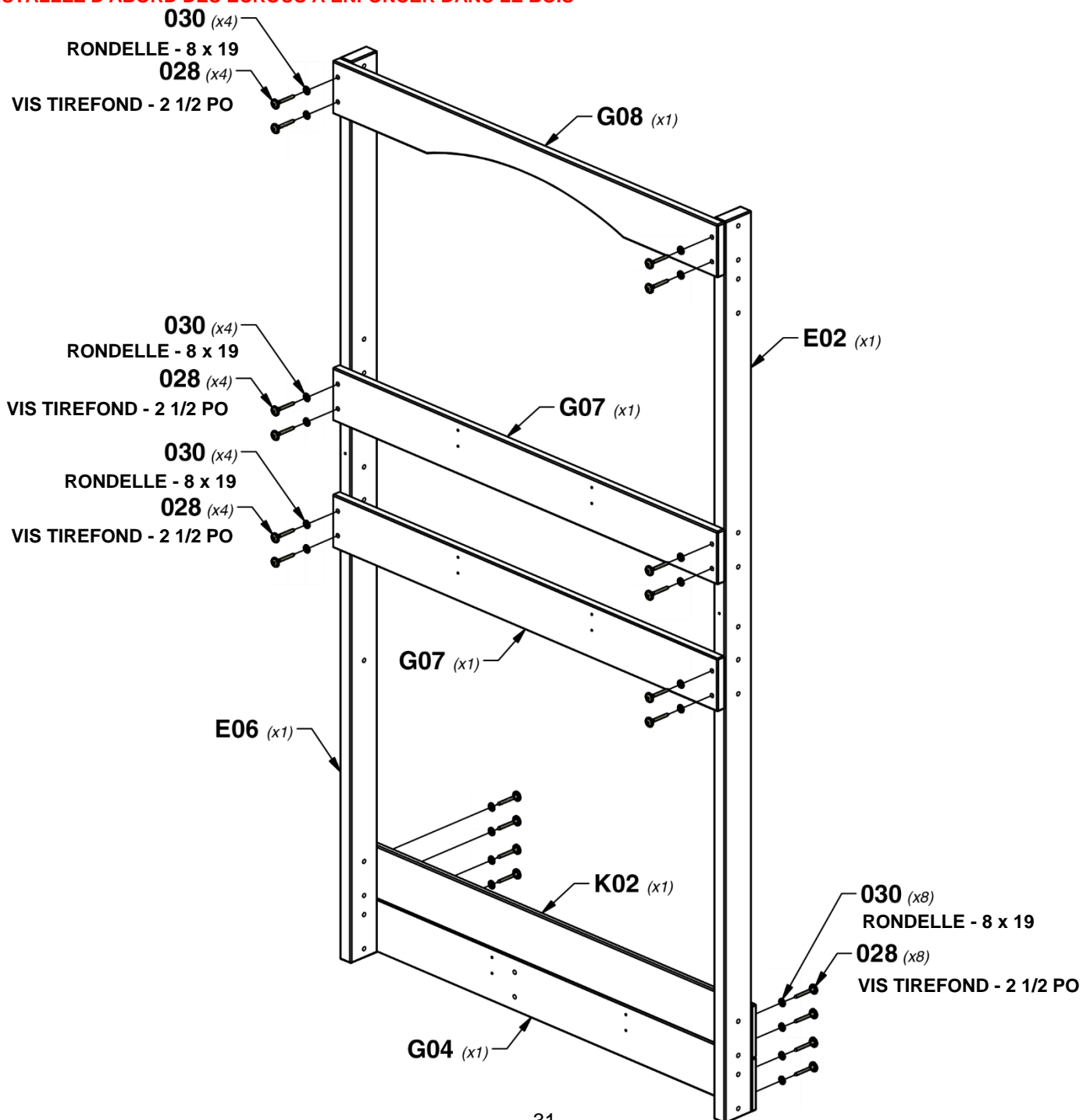

# ÉTAPE 3 - ASSEMBLAGE DU FORT

QTÉ	NUMÉRO D'ARTICLE	DESCRIPTION
2	H100013	BOULON WH 5/16 x 2 1/4
14	H100028	VIS TIREFOND WH 5/16 x 2 1/2
20	H100030	RONDELLE DE VERROUILLAGE EXT 8 x 19
10	H100074	ÉCROU À ENFONCER 5/16
2	H100138	RONDELLE DE VERROUILLAGE EXT 6 x 15
2	H100146	VIS TIREFOND WH 1/4 x 2
4	H100166	BOULON WH 5/16 x 4 1/4

**G05** | LISSE MURALE/SUPPORT DE LA BALANÇOIRE - W4L16018  
(x1) 1 po x 5 1/4 po x 49 po (24 x 134 x 1244)

**G06** | LISSE DE PLANCHER - W4L16020  
(x1) 1 po x 5 1/4 po x 49 po (24 x 134 x 1244)

**K02** | PANNEAU DE BASE/BAC À SABLE - W4L16035  
(x2) 5/8 po x 5 1/4 po x 49 po (16 x 134 x 1244)

**E04** | CALE DE LA PLATEFORME - W4L16002  
(x2) 1 3/8 po x 3 3/8 po x 15 1/2 po (36 x 86 x 394)

**E05** | PIED DE TOUR ARRIÈRE DROIT - W2A03282  
(x1) 1 3/8 po x 3 3/8 po x 89 1/2 po (36 x 86 x 2274)

**E01** | PIED DE TOUR AVANT DROIT - W4L15999  
(x1) 1 3/8 po x 3 3/8 po x 89 1/2 po (36 x 86 x 2274)

**M05** | LISSE MURALE - W4L16066  
(x1) 5/8 po x 3 3/8 po x 49 po (16 x 86 x 1244)

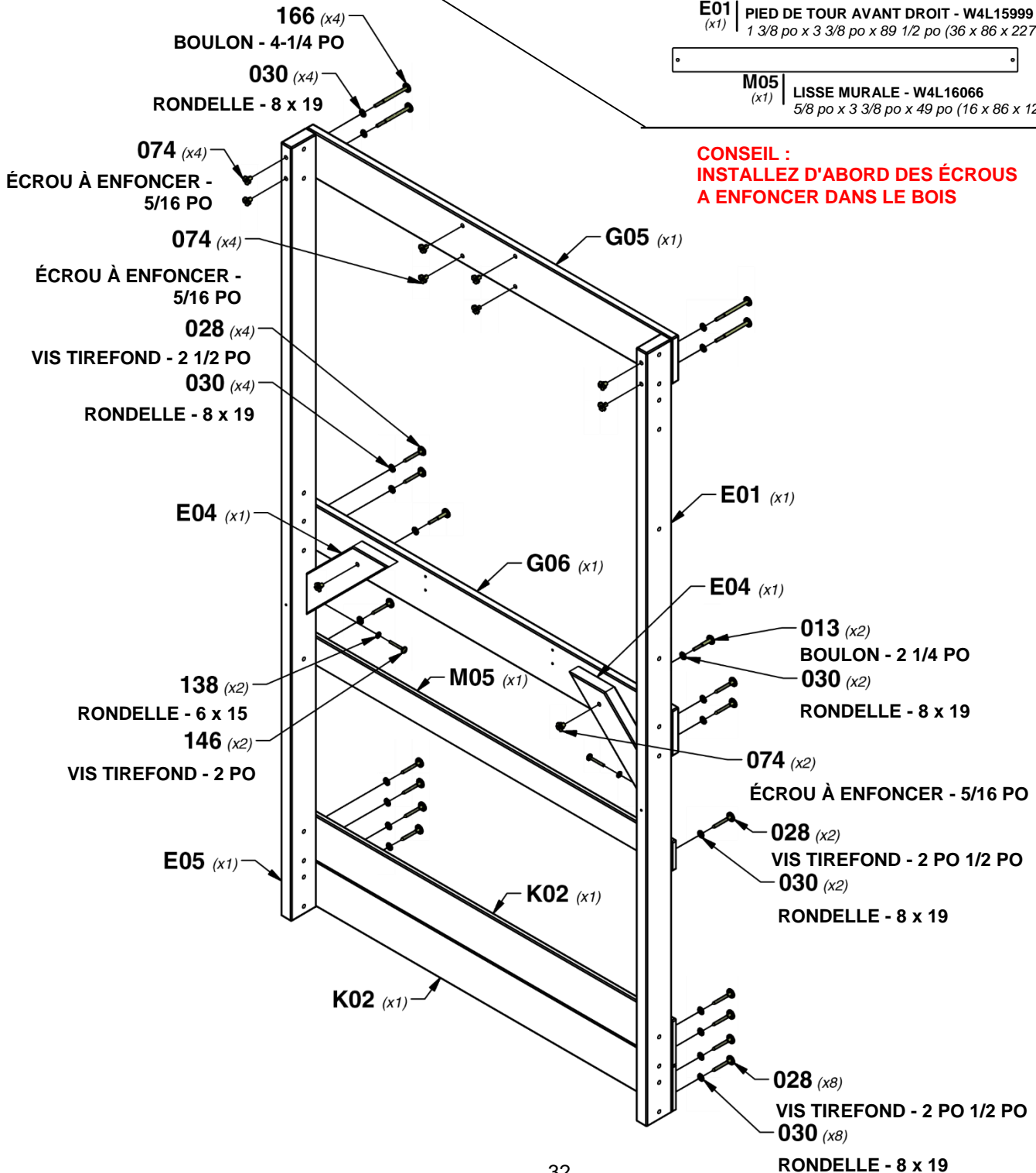

# ÉTAPE 4 - ASSEMBLAGE DU FORT

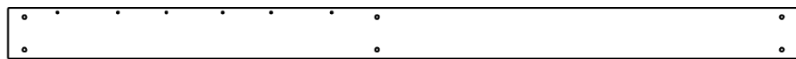

**G01** | PANNEAU DE LA BASE - W4L16009  
(x2) 5/8 po x 5 1/4 po x 82 1/4 po (16 x 134 x 2088)

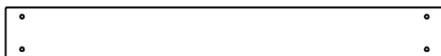

**K03** | PLANCHE DE SOL - W4L16038  
(x2) 5/8 po x 5 1/4 po x 45 1/2 po (16 x 134 x 1156)



**H05** | SUPPORT DE PLANCHE DE PLANCHER INFÉRIEUR - W4L16024  
(x4) 1 po x 3 3/8 po x 5 1/4 po (24 x 86 x 134)

QTÉ	NUMÉRO D'ARTICLE	DESCRIPTION
12	H100012	BOULON WH 5/16 x 2
8	H100016	BOULON WH 5/16 x 3
20	H100030	RONDELLE DE VERROUILLAGE EXT 8 x 19
20	H100074	ÉCROU À ENFONCER 5/16

**CONSEIL :**  
**INSTALLEZ D'ABORD DES ÉCROUS A ENFONCER DANS LE BOIS**

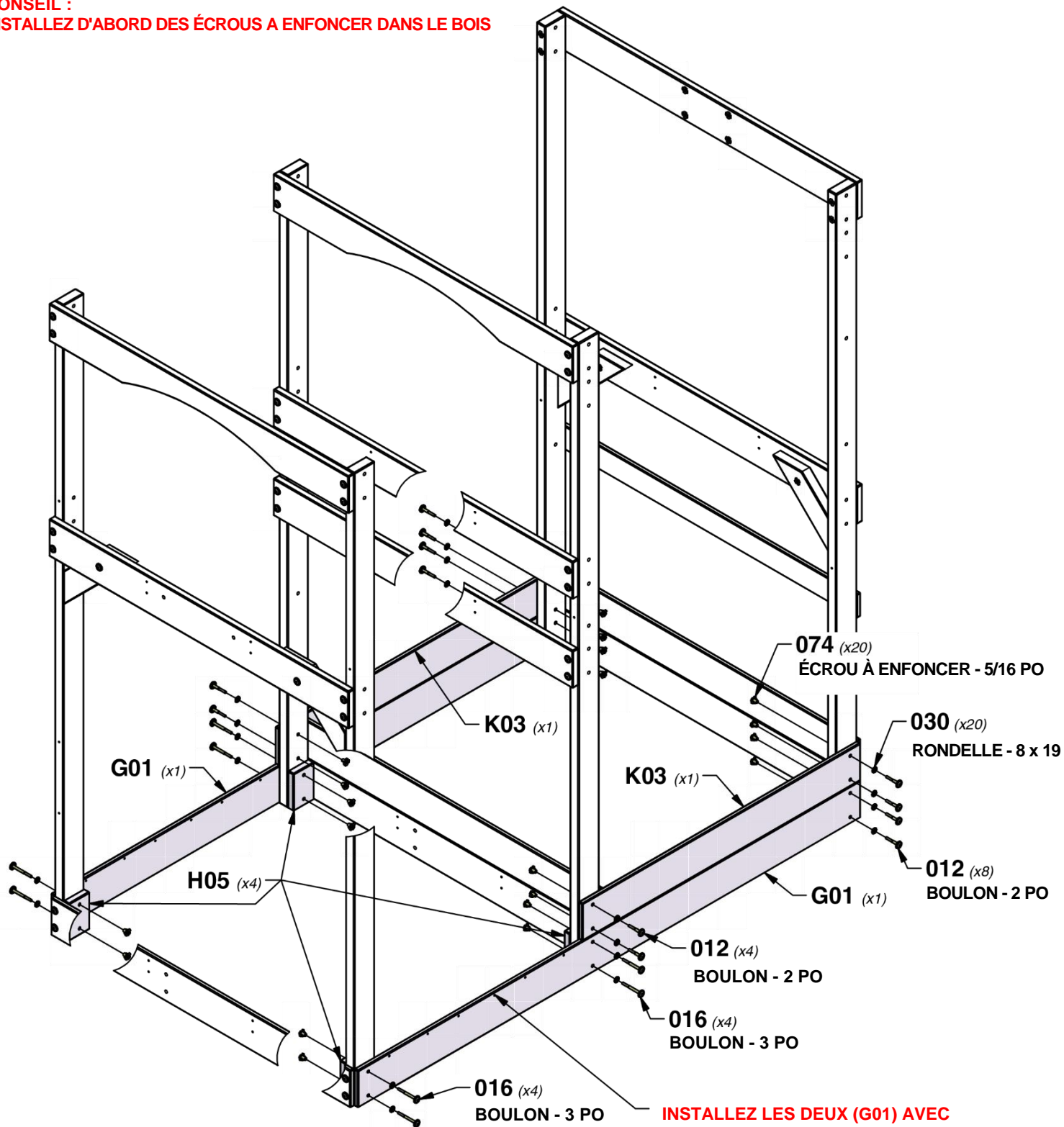

**INSTALLEZ LES DEUX (G01) AVEC  
LES AVANT-TRUS VERS LE HAUT.**

# ÉTAPE 5 - ASSEMBLAGE DU FORT



**G10** LISSE DE PLANCHER - W4L16010  
(x1) 1 po x 5 1/4 po x 45 1/2 po (24 x 134 x 1156)



**G12** LISSE DE PLANCHER - W4L16012  
(x2) 1 po x 5 1/4 po x 40 1/8 po (24 x 134 x 1018)

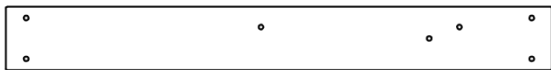

**G15** LISSE DE PLANCHER - W4L16014  
(x1) 1 po x 5 1/4 po x 45 1/2 po (24 x 134 x 1156)



**H05** SUPPORT DE PLANCHE DE PLANCHER INFÉRIEUR - W4L16024  
(x6) 1 po x 3 3/8 po x 5 1/4 po (24 x 86 x 134)

QTÉ	NUMÉRO D'ARTICLE	DESCRIPTION
4	H100013	BOULON WH 5/16 x 2 1/4
12	H100017	BOULON WH 5/16 x 3 1/4
16	H100030	RONDELLE DE VERROUILLAGE EXT 8 x 19
16	H100074	ÉCROU À ENFONCER 5/16

**CONSEIL :**  
INSTALLER D'ABORD DES ÉCROUS A ENFONCER DANS LE BOIS

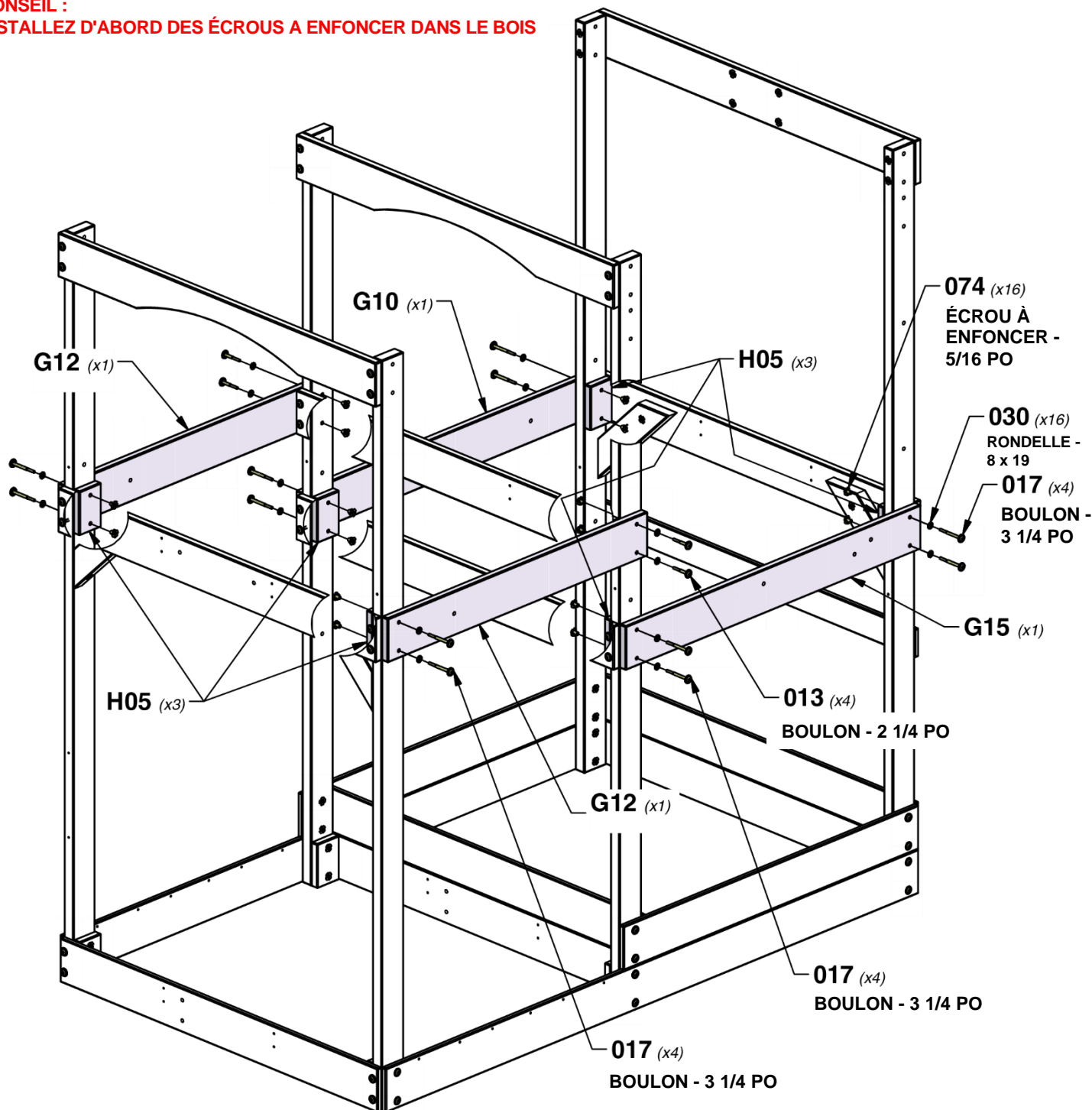

# ÉTAPE 6 - ASSEMBLAGE DU FORT

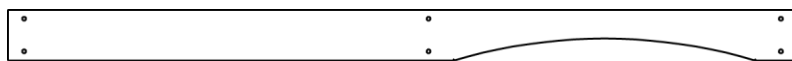

**G02** LISSE MURALE - W4L16015  
(x1) 1 po x 5 1/4 po x 82 1/4 po (24 x 134 x 2088)

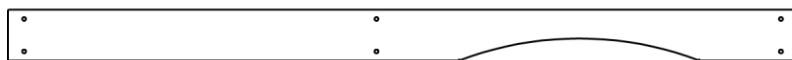

**G03** LISSE MURALE - W4L16016  
(x1) 1 po x 5 1/4 po x 82 1/4 po (24 x 134 x 2088)



**K01** LISSE MURALE - W4L16034  
(x1) 5/8 po x 5 1/4 po x 45 1/2 po (16 x 134 x 1156)

QTÉ	NUMÉRO D'ARTICLE	DESCRIPTION
16	H100013	BOULON WH 5/16 x 2 1/4
16	H100030	RONDELLE DE VERROUILLAGE EXT 8 x 19
16	H100074	ÉCROU À ENFONCER 5/16

**CONSEIL :**  
**INSTALLEZ D'ABORD DES ÉCROUS A ENFONCER DANS LE BOIS**

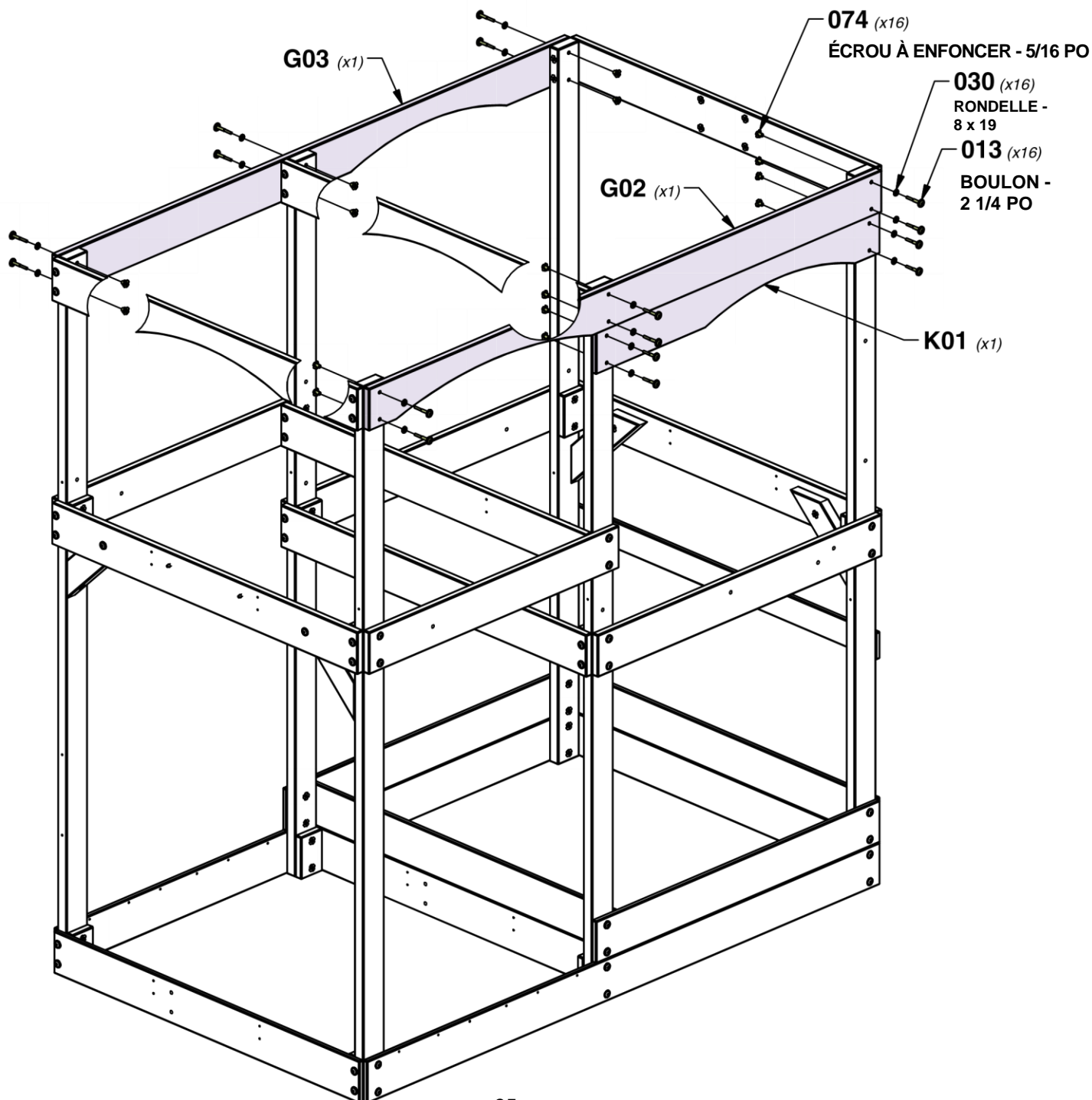

# ÉTAPE 7 - ASSEMBLAGE DU FORT

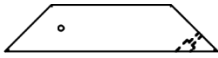

**E04** | RENFORT D'ANGLE STANDARD - W4L16342  
(x4) 1 3/8 po x 2 3/8 po x 13 po (36 x 60 x 330)

QTÉ	NUMÉRO D'ARTICLE	DESCRIPTION
16	H100013	BOULON WH 5/16 x 2 1/4
16	H100030	RONDELLE DE VERROUILLAGE EXT 8 x 19
16	H100074	ÉCROU À ENFONCER 5/16

**CONSEIL :**  
INSTALLER D'ABORD DES ÉCROUS A ENFONCER DANS LE BOIS

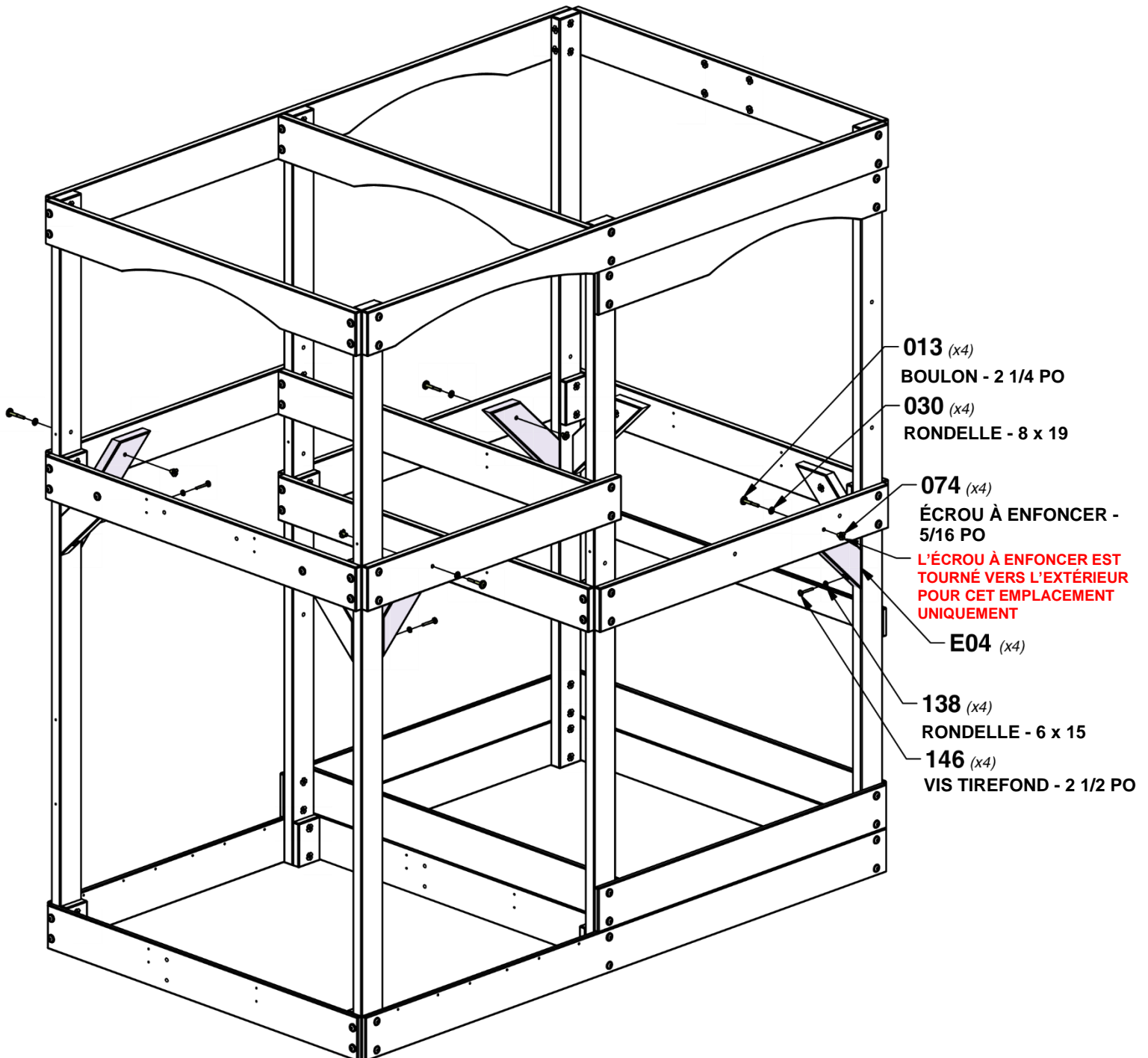

# ÉTAPE 8 - ASSEMBLAGE DU FORT

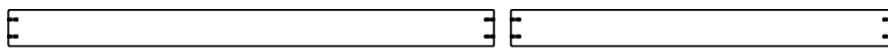

**H01** | SUPPORT DE PLANCHER - W103980  
(x2) | 1 po x 3 3/8 po x 40 3/8 po (24 x 86 x 1024)

**H09** | SOLIVE DE SOL - W4L16032  
(x2) | 1 po x 3 3/8 po x 35 3/4 po (24 x 86 x 908)

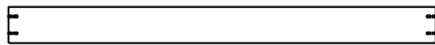

**H03** | SOLIVE DE PLANCHER - W4L16026  
(x2) | 1 po x 3 3/8 po x 40 1/8 po (24 x 86 x 1018)



**A100314** | ÉTIQUETTE DE CONTRÔLE « A »  
(x1)

QTÉ	NUMÉRO D'ARTICLE	DESCRIPTION
24	H100090	VIS TÊTE PLATE PFH 8 x 2 1/2
2	H100128	VIS TÊTE BOMBÉE CRUCIFORME PWH 8 x 5/8

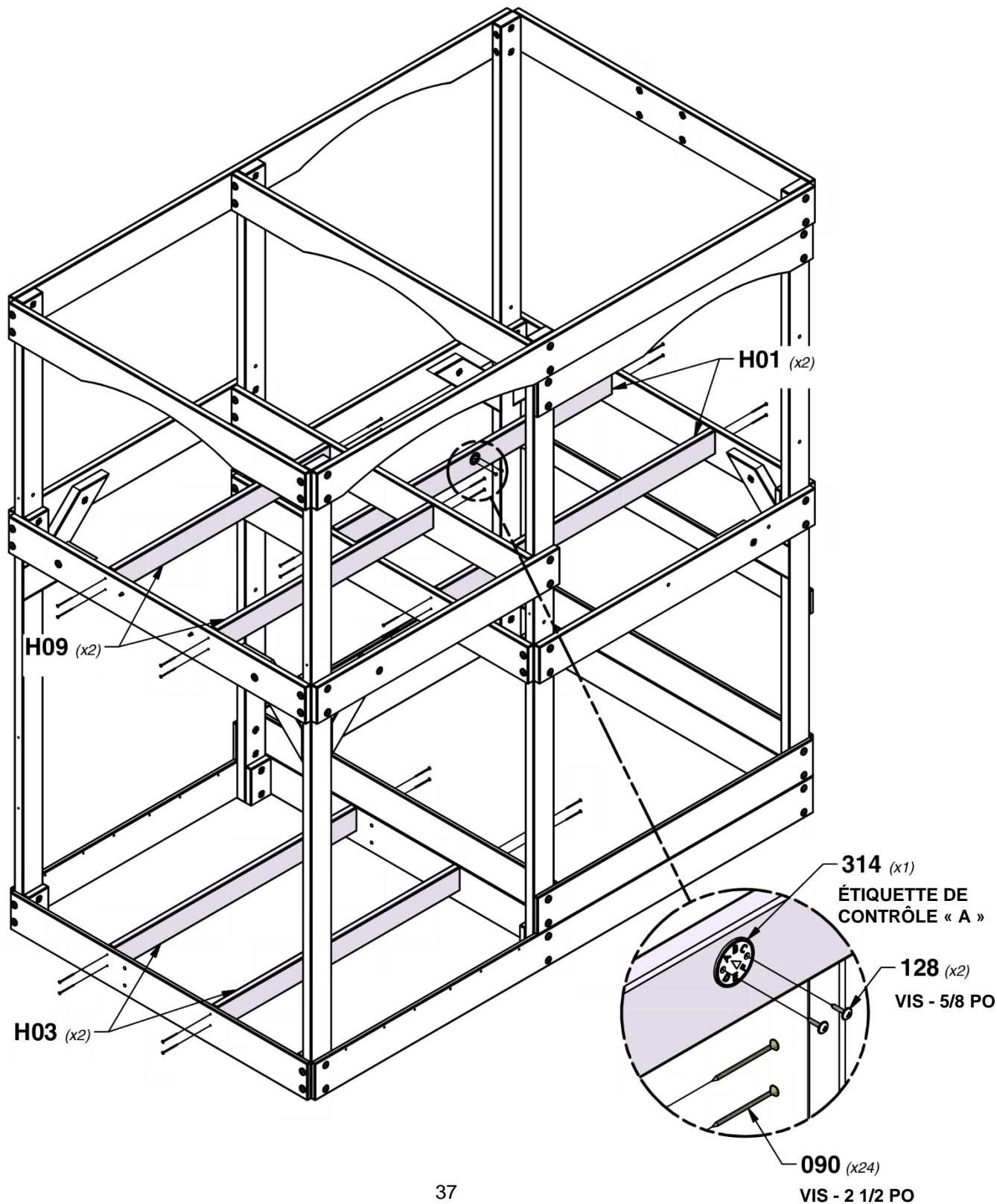

# ÉTAPE 9 - ASSEMBLAGE DU FORT



**H04** | MONTANT DE SIÈGE - W4L16027  
(x2) 1 po x 3 3/8 po x 19 po (24 x 86 x 482)

QTÉ	NUMÉRO D'ARTICLE	DESCRIPTION
4	H100010	BOULON WH 5/16 x1 1/2
4	H100030	RONDELLE DE VERROUILLAGE EXT 8 x 19
4	H100074	ÉCROU À ENFONCER 5/16

**CONSEIL :**  
INSTALLER D'ABORD DES ÉCROUS A ENFONCER DANS LE BOIS

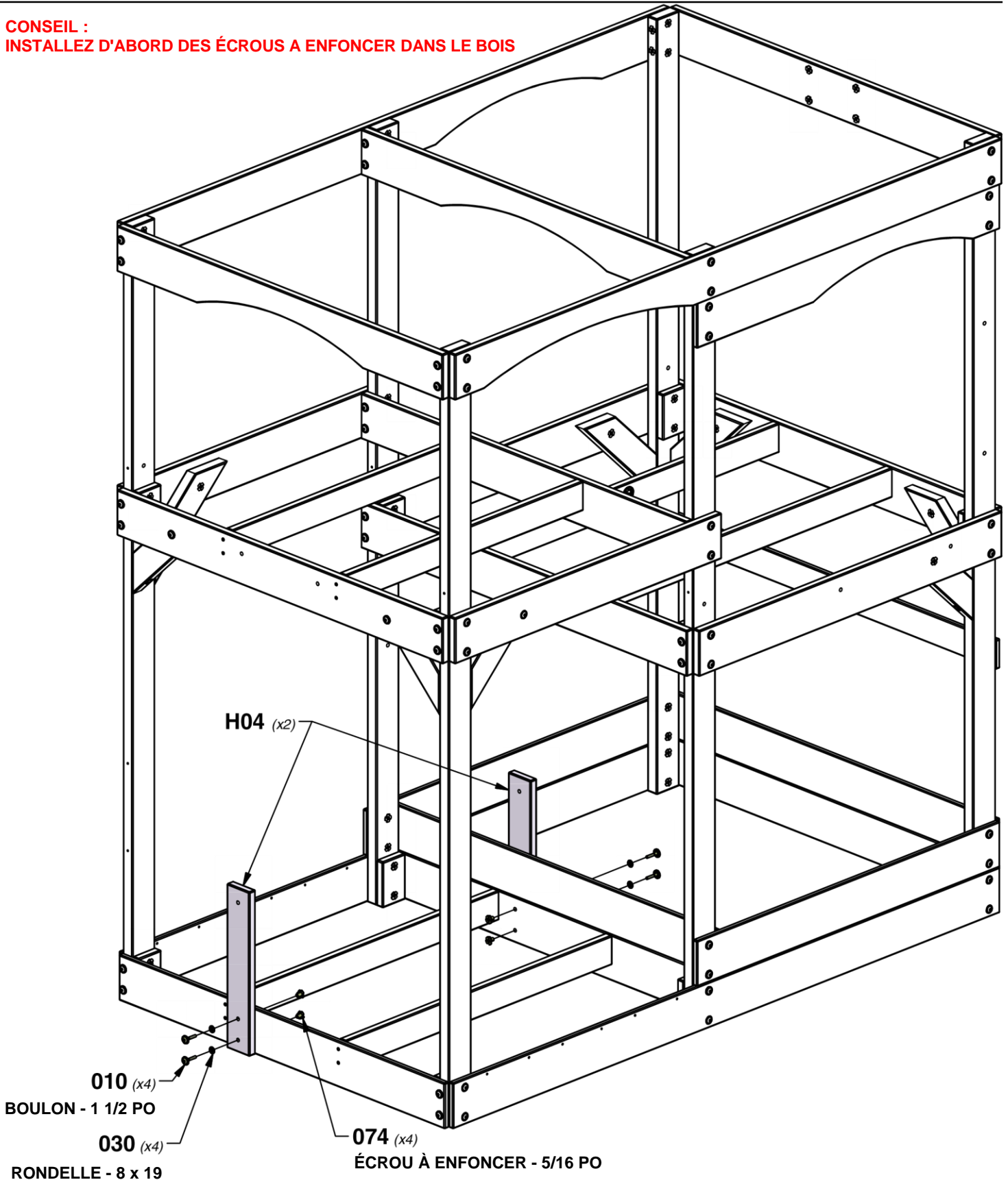

# ÉTAPE 10 - ASSEMBLAGE DU FORT

QTÉ	NUMÉRO D'ARTICLE	DESCRIPTION
26	H100086	VIS TÊTE PLATE PFH 8 x 1-1/2 PO
12	H100086	VIS TÊTE PLATE PFH 8 x 1-3/4 PO

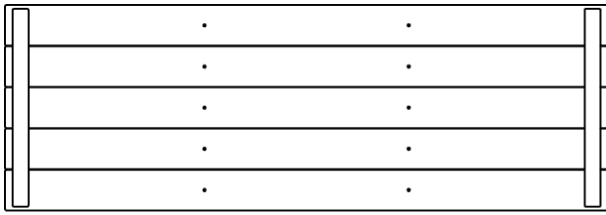

**FP1** | LATTE MURALE - W103995  
(x1) 5/8 po x 3 3/8 po x 12 7/8 po (16 x 86 x 326)

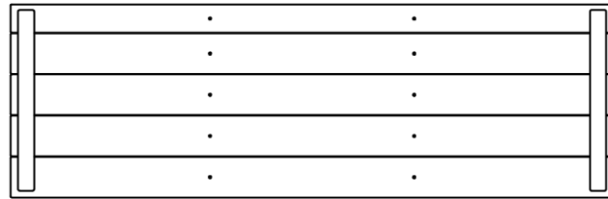

**FP2** | PANNEAU DE PLANCHER - W2A03282  
(x1) 1 5/8 po x 16 1/8 po x 50 1/4 po (40 x 408 x 1276)

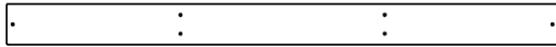

**M02** | PLANCHE DE PLANCHER - W4L16055  
(x1) 5/8 po x 3 3/8 po x 46 po (16 x 86 x 1168)

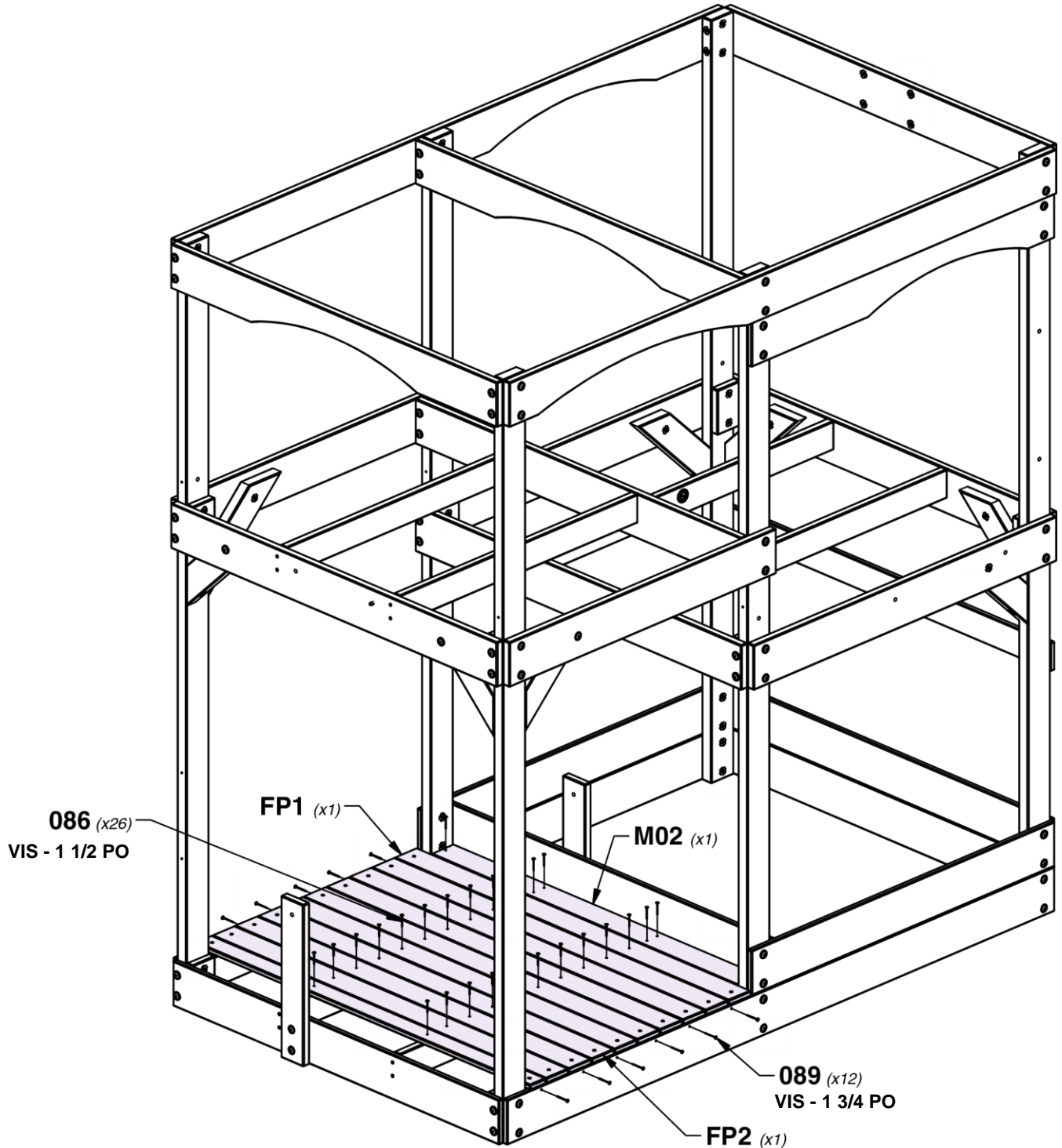

# ÉTAPE 11 - ASSEMBLAGE DU FORT

QTÉ	NUMÉRO D'ARTICLE	DESCRIPTION
78	H100086	VIS TÊTE PLATE PFH 8 x 1-1/2 PO

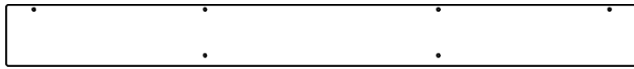

**L01** | PLANCHE DE PLANCHER DE REMPLISSAGE EXTÉRIEURE - W4L16039  
(x2) 5/8 po x 4 3/8 po x 46 po (16 x 112 x 1168)



**M03** | PLANCHE DE PLANCHER - W4L16063  
(x11) 5/8 po x 3 3/8 po x 50 7/8 po (16 x 86 x 1292)

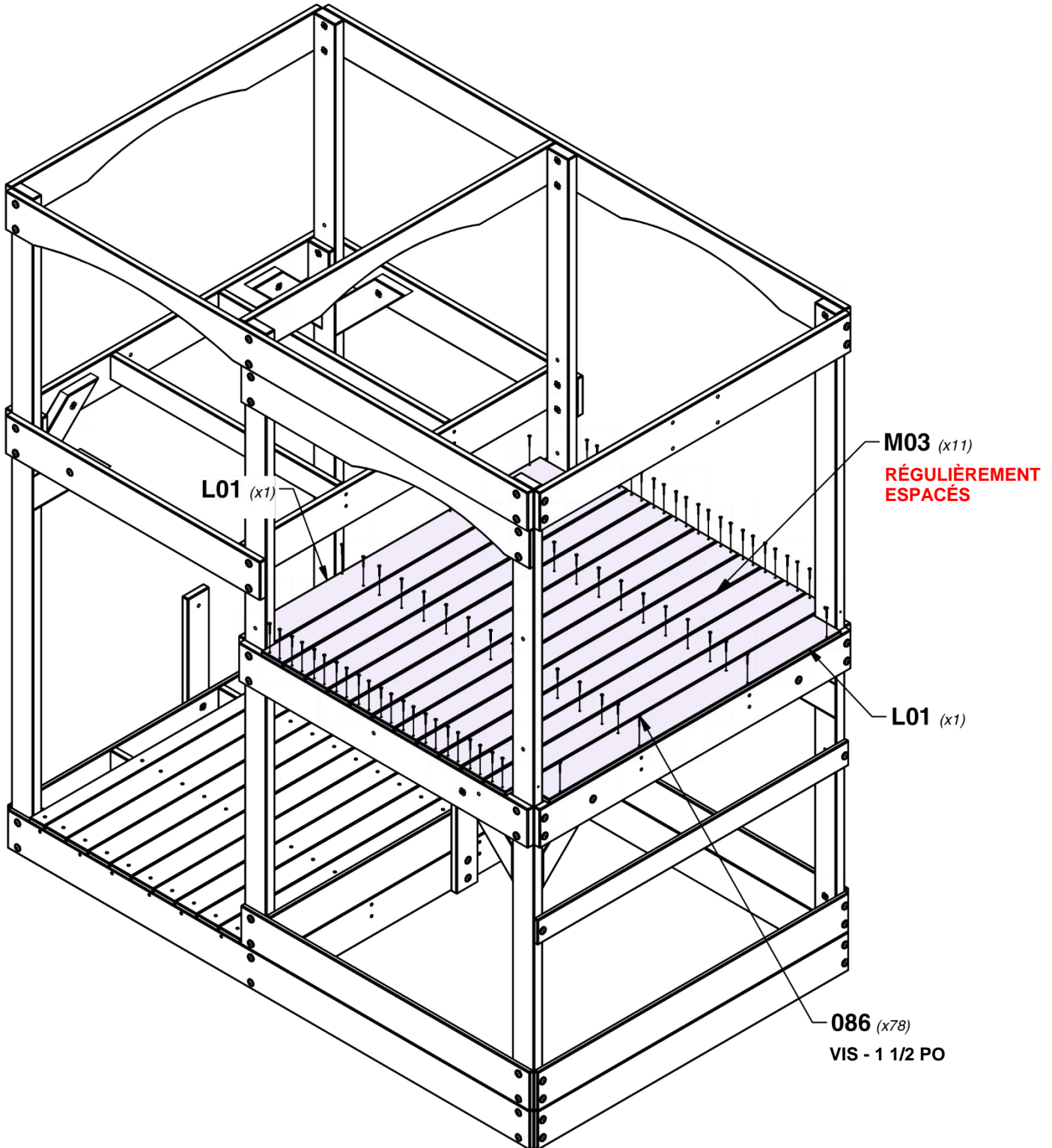

## ÉTAPE 12 - ASSEMBLAGE DU FORT

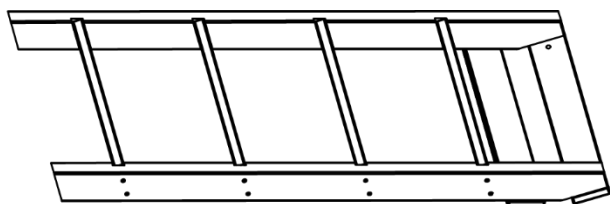

ASSEMBLAGE DE L'ÉCHELLE

QTÉ	NUMÉRO D'ARTICLE	DESCRIPTION
2	H100011	BOULON WH 5/16 x 1 3/4
2	H100030	RONDELLE DE VERROUILLAGE EXT 8 x 19
2	H100074	ÉCROU À ENFONCER 5/16

**CONSEIL :**  
**INSTALLEZ D'ABORD DES ÉCROUS A ENFONCER DANS LE BOIS**

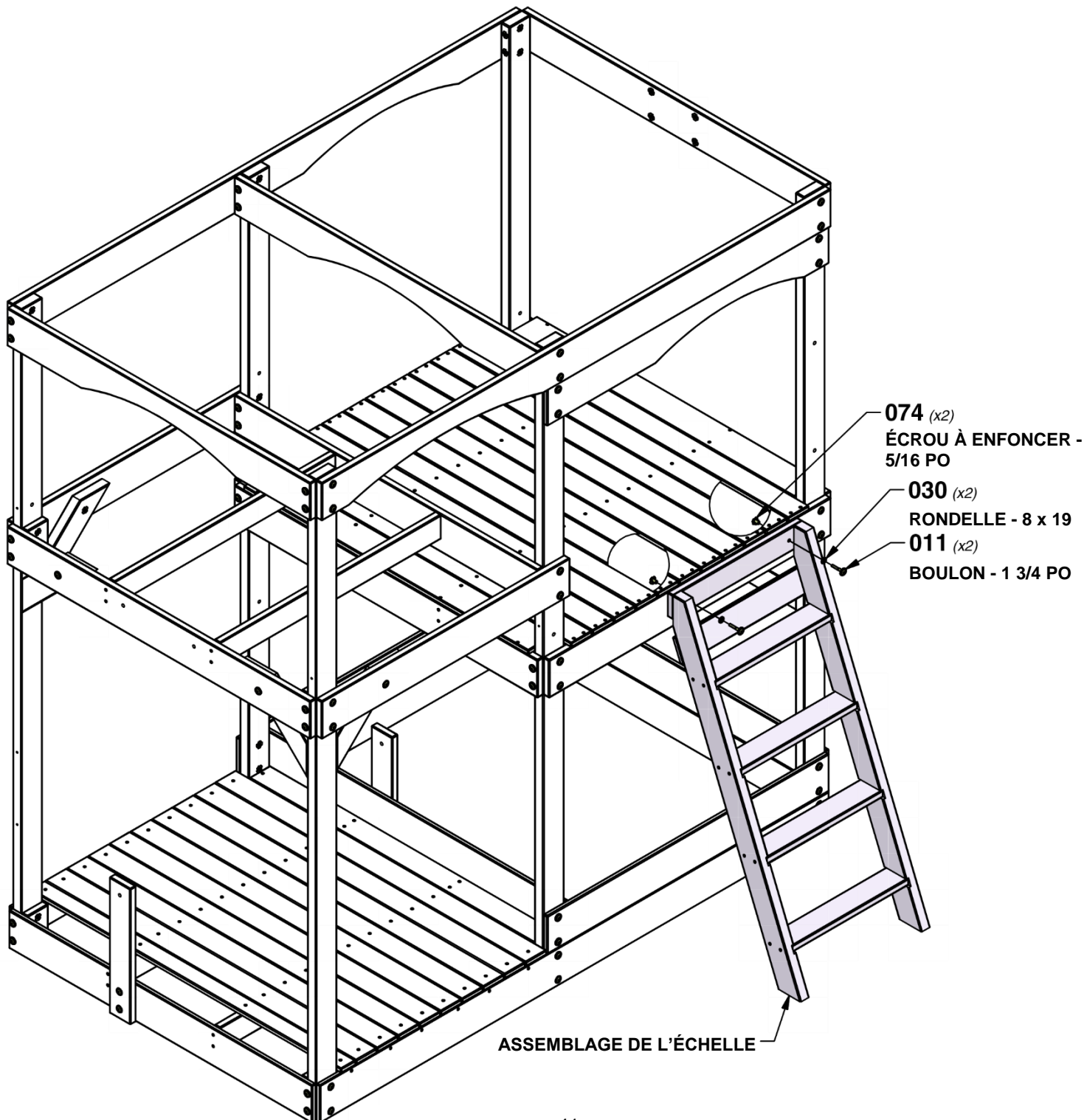

# ÉTAPE 13 - ASSEMBLAGE DU FORT

QTÉ	NUMÉRO D'ARTICLE	DESCRIPTION
64	H100086	VIS TÊTE PLATE PFH 8 x 1-1/2 PO

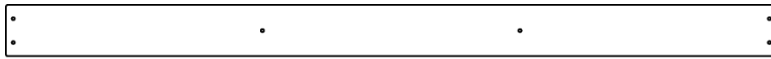

**M03** | PLANCHE DE PLANCHER - W4L16063  
(x9) 5/8 po x 3 3/8 po x 50 7/8 po (16 x 86 x 1292)



**L01** | PLANCHE DE PLANCHER DE REMPLISSAGE  
(x1) EXTÉRIEURE - W4L16039  
5/8 po x 4 3/8 po x 46 po (16 x 112 x 1168)



**N01** | PLANCHE DE PLANCHER - W4L16076  
(x1) 5/8 po x 2 3/8 po x 50 7/8 po (16 x 60 x 1292)

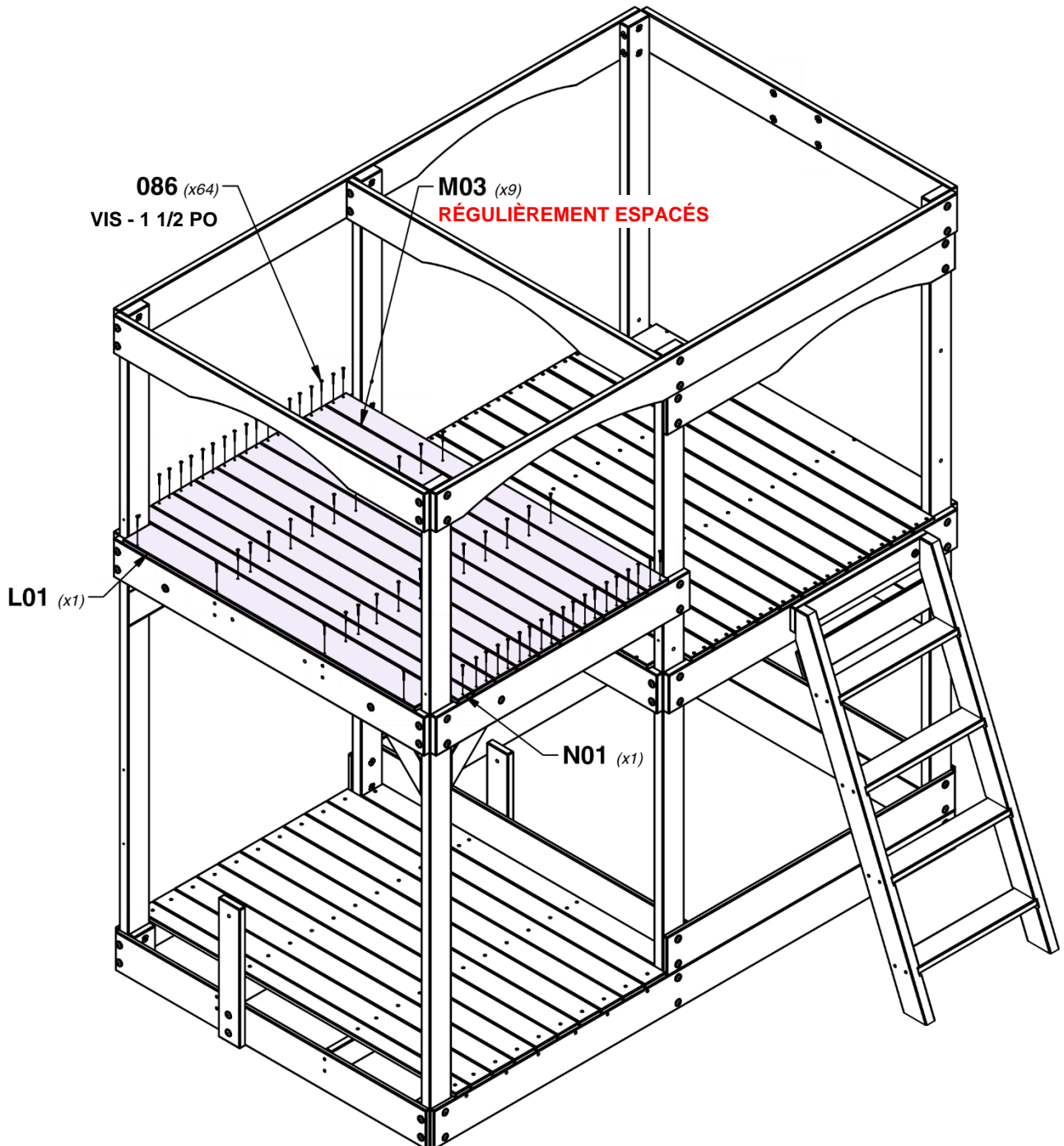

# ÉTAPE 14 - ASSEMBLAGE DU FORT

QTÉ	NUMÉRO D'ARTICLE	DESCRIPTION
6	H100012	BOULON WH 5/16 x 2
6	H100030	RONDELLE DE VERROUILLAGE EXT 8 x 19
6	H100074	ÉCROU À ENFONCER 5/16



**M06** LISSE MURALE - W4L16067  
(x2) 5/8 po x 3 3/8 po x 45 1/2 po (16 x 86 x 1156)

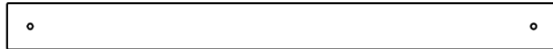

**M11** LISSE MURALE - W4L16047  
(x1) 5/8 po x 3 3/8 po x 40 1/8 po (16 x 86 x 1018)

**CONSEIL :**  
**INSTALLEZ D'ABORD DES ÉCROUS A ENFONCER**  
**DANS LE BOIS**

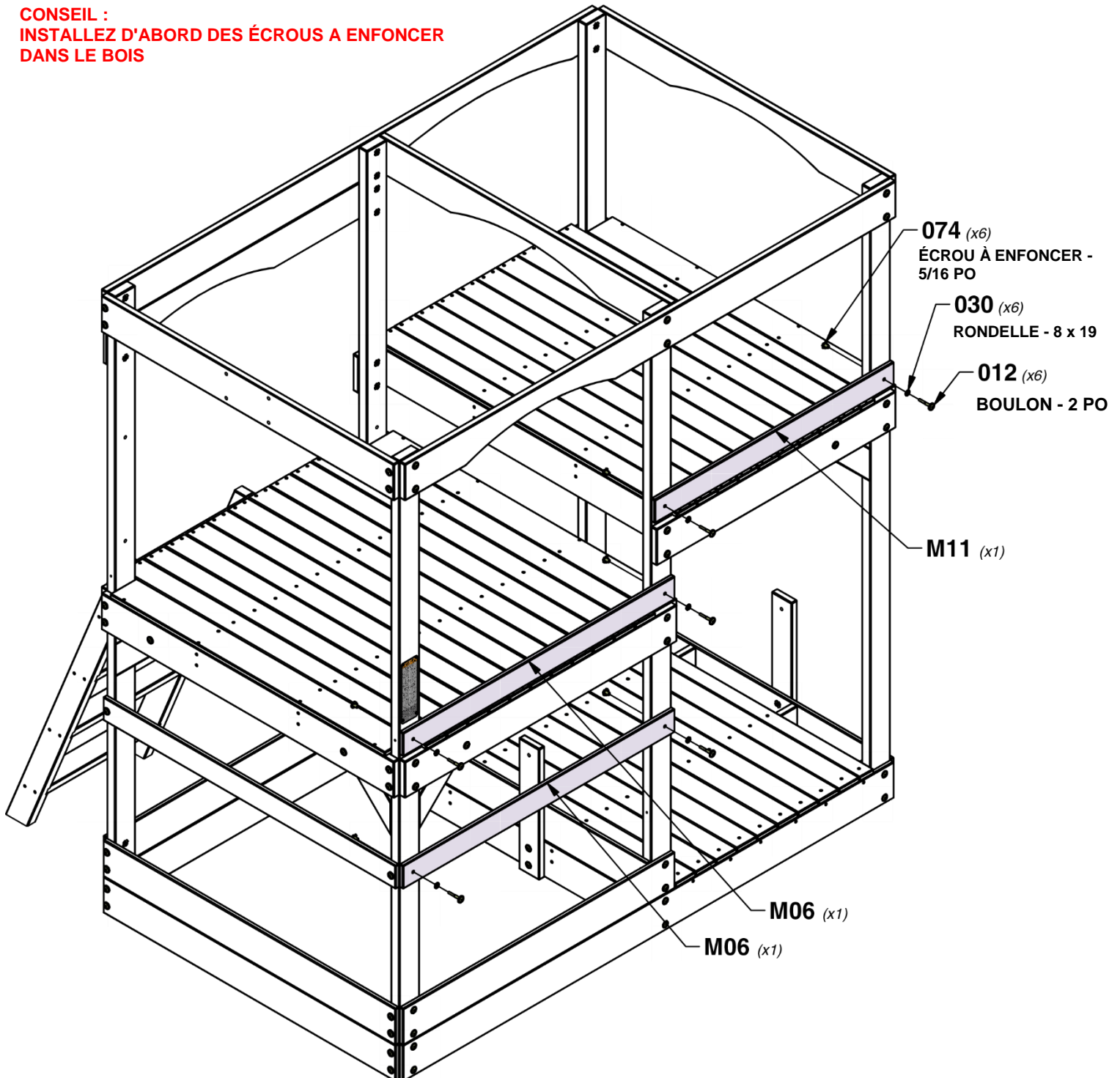

# ÉTAPE 15 - ASSEMBLAGE DU FORT



**M05** LISSE MURALE - W4L16066  
(x1) 5/8 po x 3 3/8 po x 49 po (16 x 86 x 1244)



**M18** LISSE MURALE - W4L16053  
(x1) 5/8 po x 3 3/8 po x 16 7/8 po (16 x 86 x 430)

QTÉ	NUMÉRO D'ARTICLE	DESCRIPTION
1	H100012	BOULON WH 5/16 x 2
2	H100028	VIS TIREFOND WH 5/16 x 2 1/2
3	H100030	RONDELLE DE VERROUILLAGE EXT 8 x 19
1	H100074	ÉCROU À ENFONCER 5/16

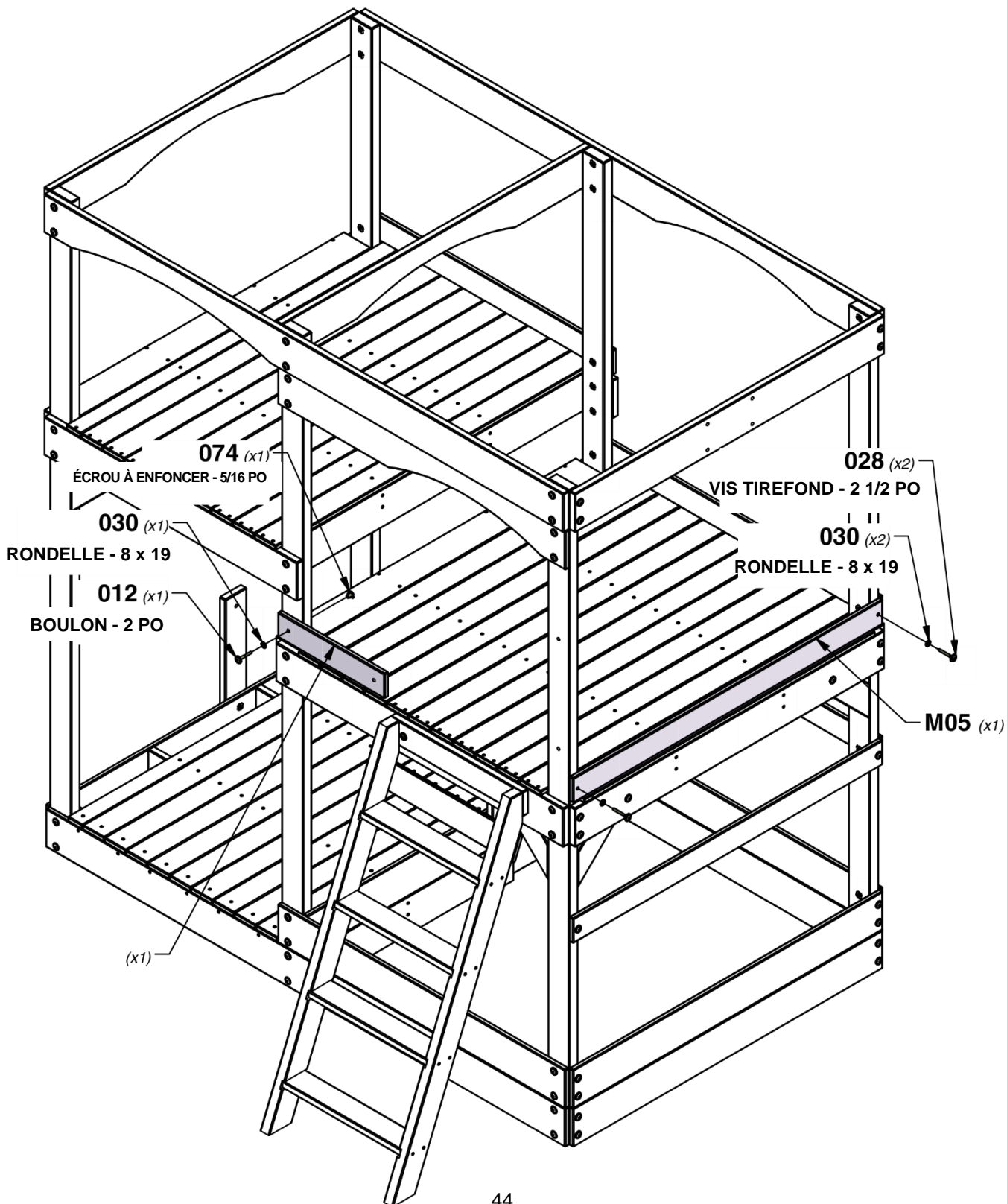

# ÉTAPE 16 - ASSEMBLAGE DU FORT



**M05** LISSE MURALE - W4L16066  
(x1) 5/8 po x 3 3/8 po x 49 po (16 x 86 x 1244)

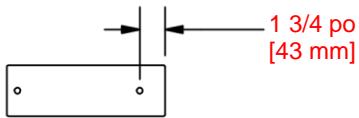

**M21** LISSE MURALE - W4L16057  
(x2) 5/8 po x 3 3/8 po x 10 1/2 po (16 x 86 x 268)

QTÉ	NUMÉRO D'ARTICLE	DESCRIPTION
4	H100028	VIS TIREFOND WH 5/16 x 2 1/2
4	H100030	RONDELLE DE VERROUILLAGE EXT 8 x 19

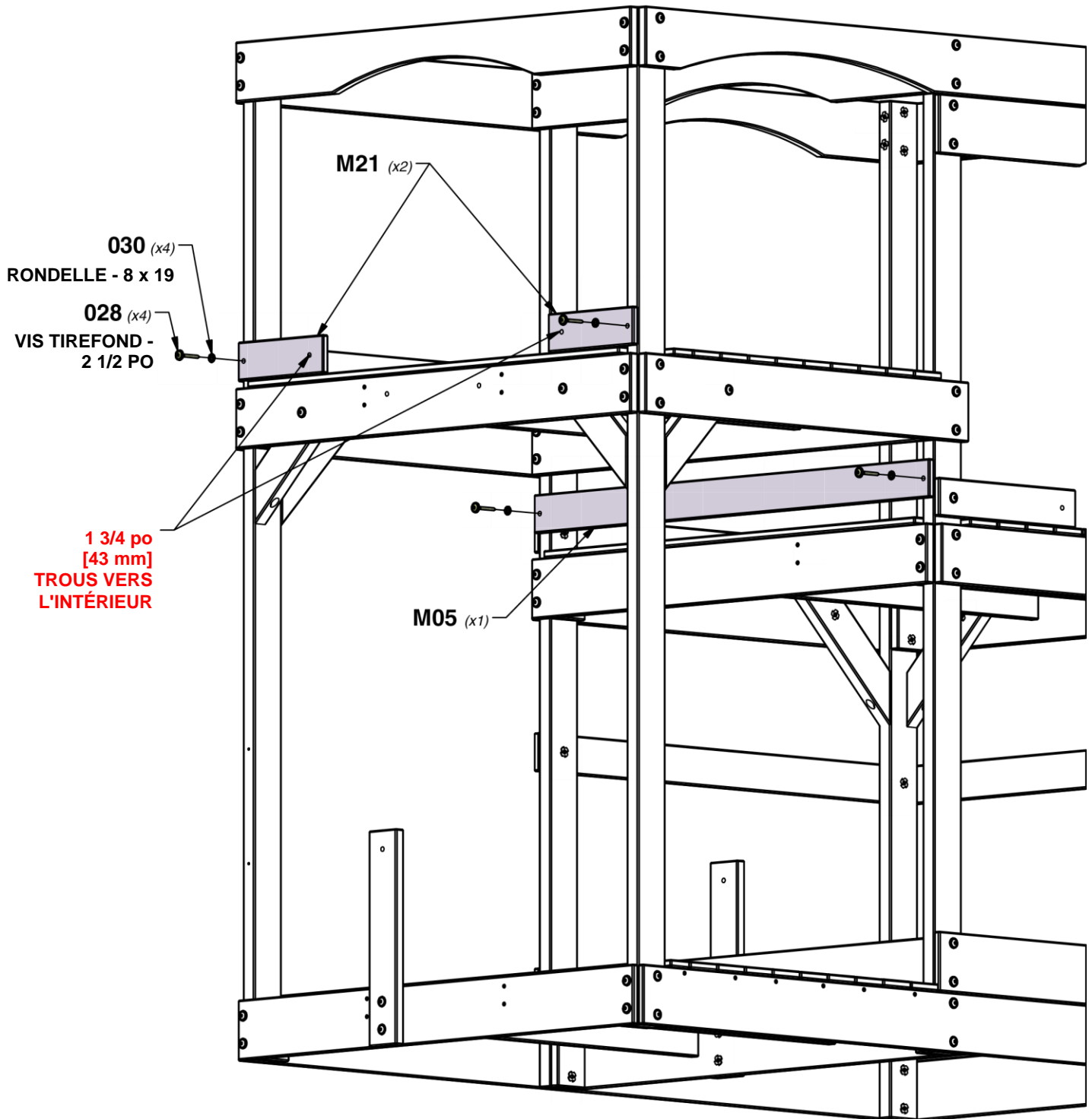

# ÉTAPE 17 - ASSEMBLAGE DU FORT



**M09** | PANNEAU MURAL - W4L16075  
 (x6) | 5/8 po x 3 3/8 po x 32 po (16 x 86 x 812)

QTÉ	NUMÉRO D'ARTICLE	DESCRIPTION
24	H100188	VIS TÊTE PLATE PFH 8 x 1-1/8 PO

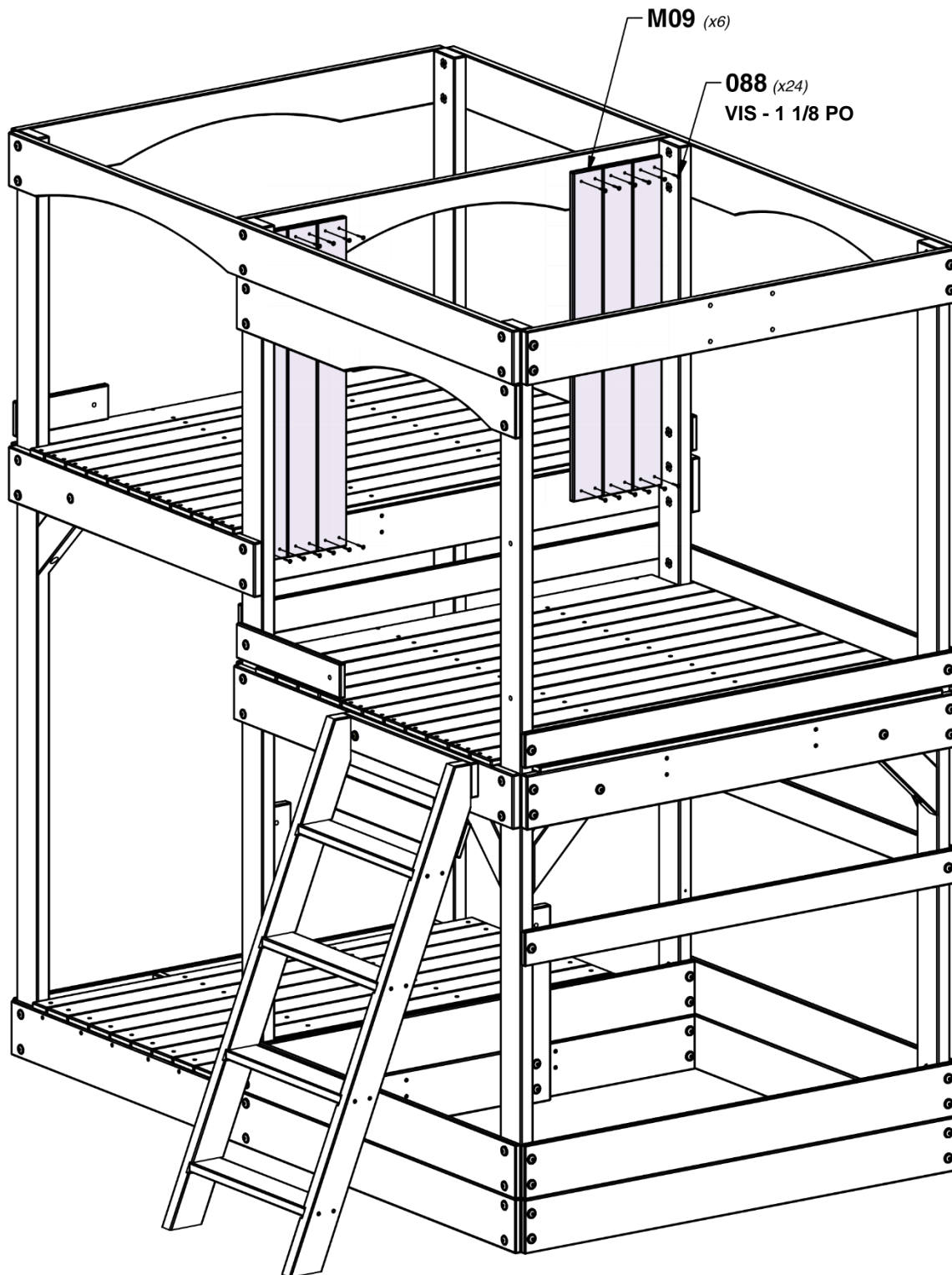
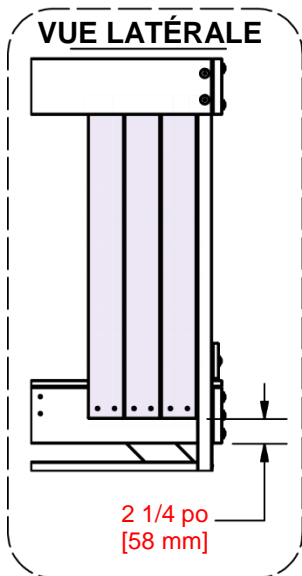

# ÉTAPE 18 - ASSEMBLAGE DU FORT

QTÉ	NUMÉRO D'ARTICLE	DESCRIPTION
2	H100005	ÉCROU À PORTÉE CYLINDRIQUE WH 5/16 x 7/8
2	H100008	BOULON WH 5/16 x 1
2	H100031	RONDELLE DE VERROUILLAGE EXT 12 x 19
2	H100074	ÉCROU À ENFONCER 5/16
12	H100088	VIS TÊTE PLATE PFH 8 x 1-1/8 PO
2	H100115	BOULON WH 5/16 x 1/2

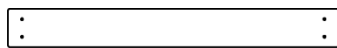

**M24** PANNEAU MURAL - W4L16061  
(x2) 5/8 po x 3 3/8 po x 29 5/8 po (16 x 86 x 752)



**A4M01046** SUPPORT EN L  
(x2) 2,5 x 38 x 55 x 55

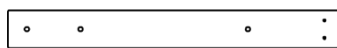

**M26** PANNEAU MURAL - W4L16091  
(x2) 5/8 po x 3 3/8 po x 29 5/8 po (16 x 86 x 752)

**HAUT**

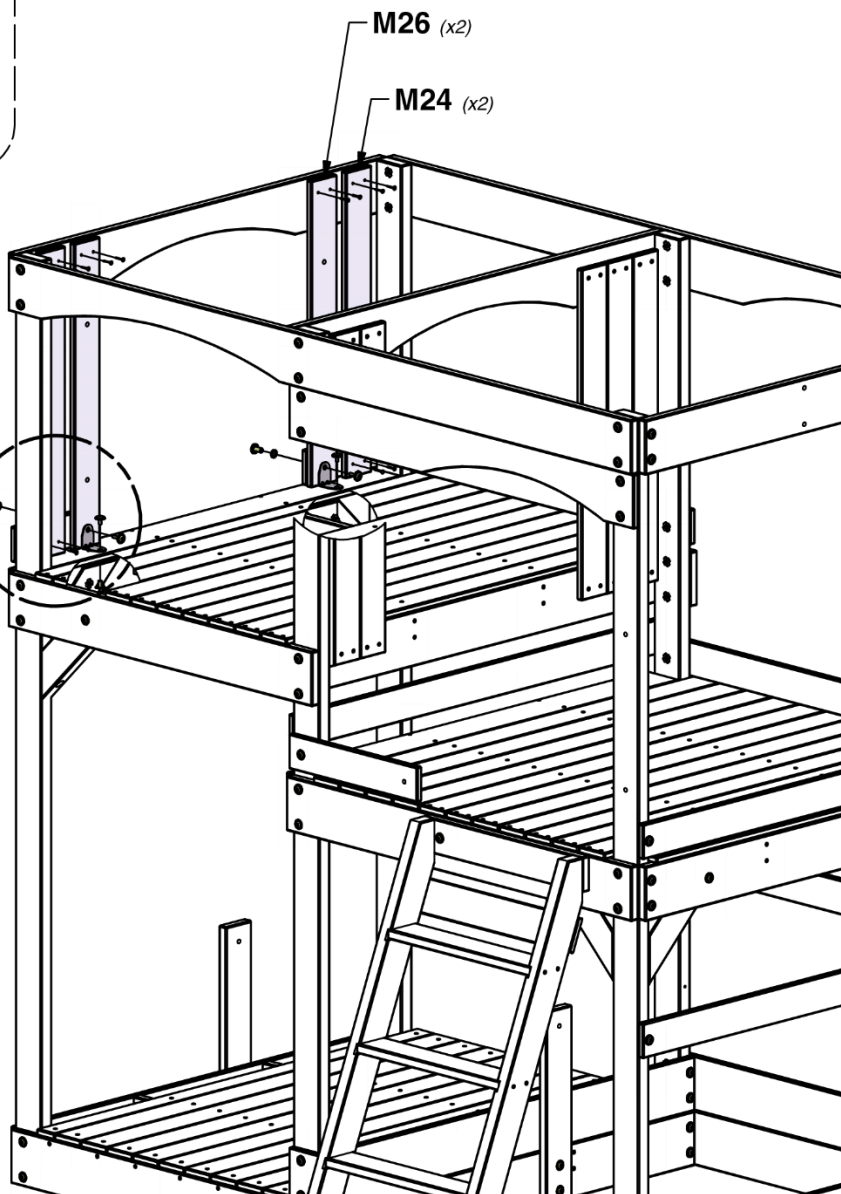
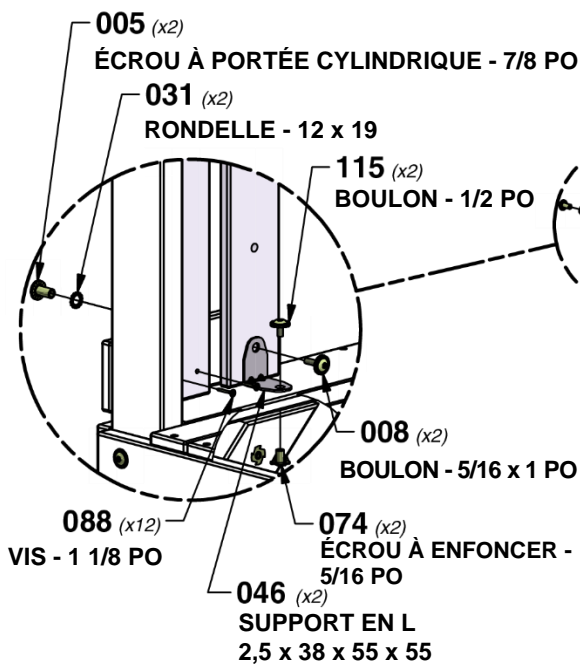
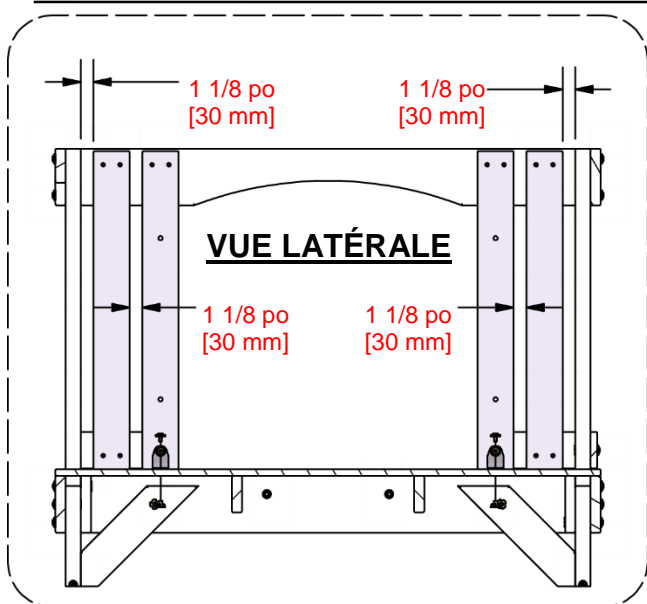

**EN UTILISANT LE SUPPORT EN L  
COMME GUIDE, PERCEZ (2) TROUS DE  
3/8 po [10 mm] À TRAVERS LE  
PLANCHER POUR LA QUINCAILLERIE**

# ÉTAPE 19 - ASSEMBLAGE DU FORT

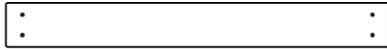

**M24** PANNEAU MURAL - W4L16061  
(x5) 5/8 po x 3 3/8 po x 29 5/8 po (16 x 86 x 752)

QTÉ	NUMÉRO D'ARTICLE	DESCRIPTION
20	H100086	VIS TÊTE PLATE PFH 8 x 1-1/8 PO

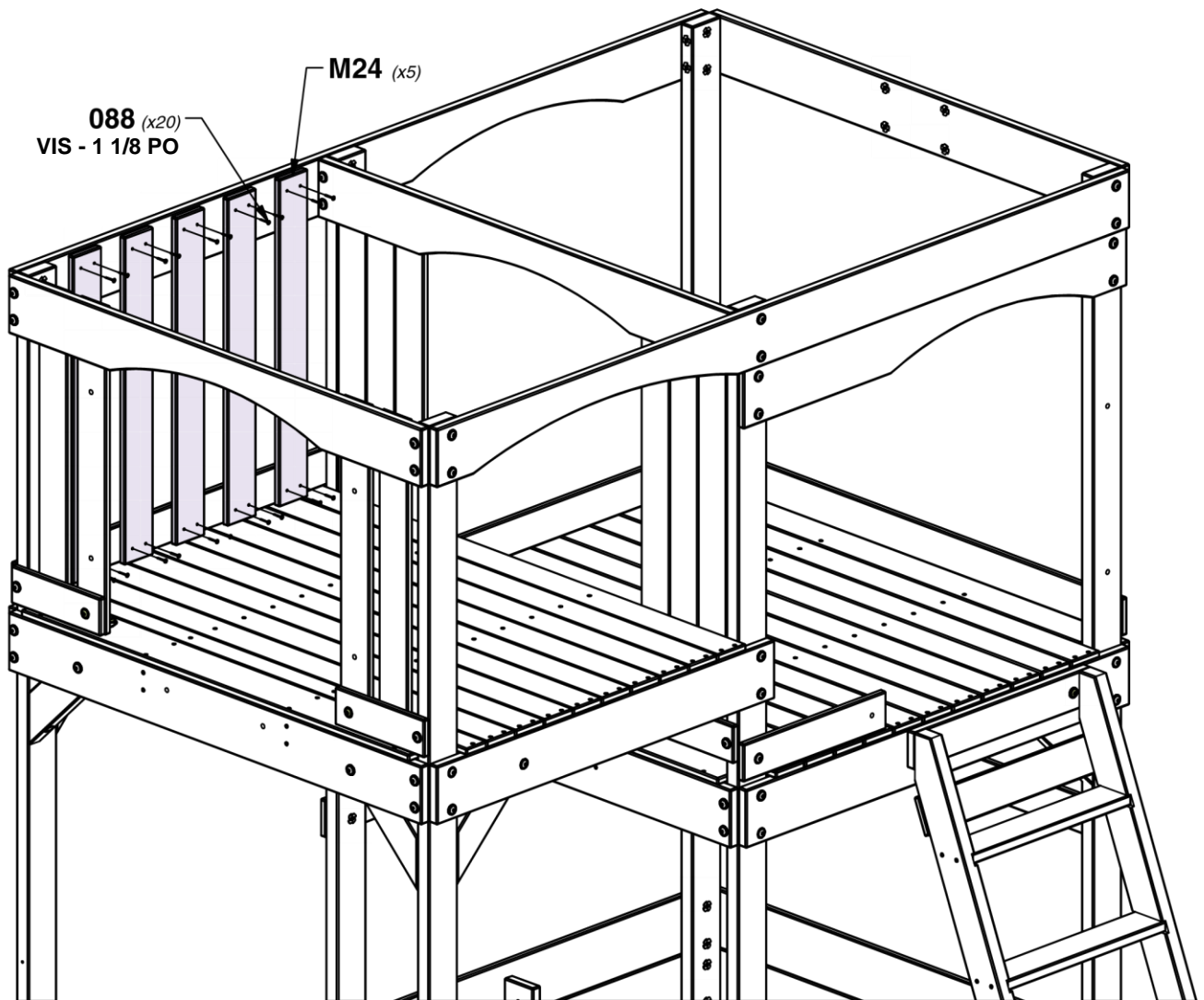
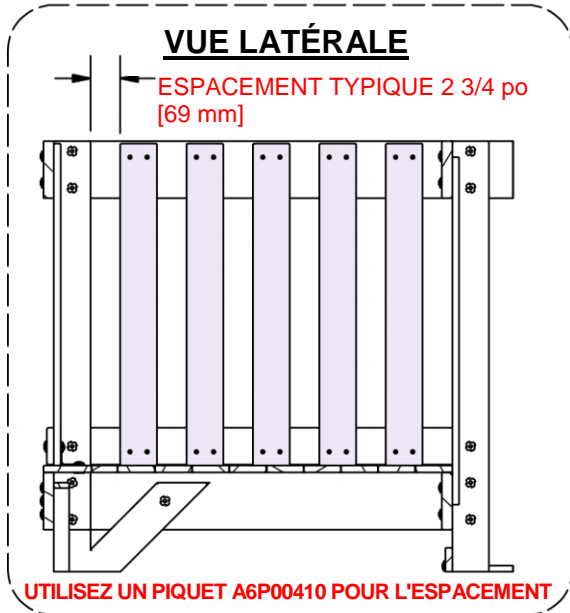

# ÉTAPE 20 - ASSEMBLAGE DU FORT

QTÉ	NUMÉRO D'ARTICLE	DESCRIPTION
16	H100188	VIS TÊTE PLATE PFH 8 x 1-1/8 PO

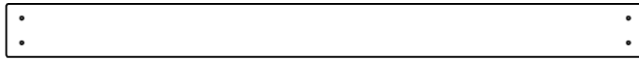

**M08** | PANNEAU MURAL - W4L16074  
(x2) 5/8 po x 3 3/8 po x 41 po (16 x 86 x 1040)

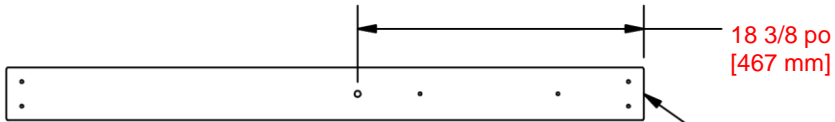

**M17** | PANNEAU MURAL - W4L16090  
(x2) 5/8 po x 3 3/8 po x 41 po (16 x 86 x 1040)

**HAUT**

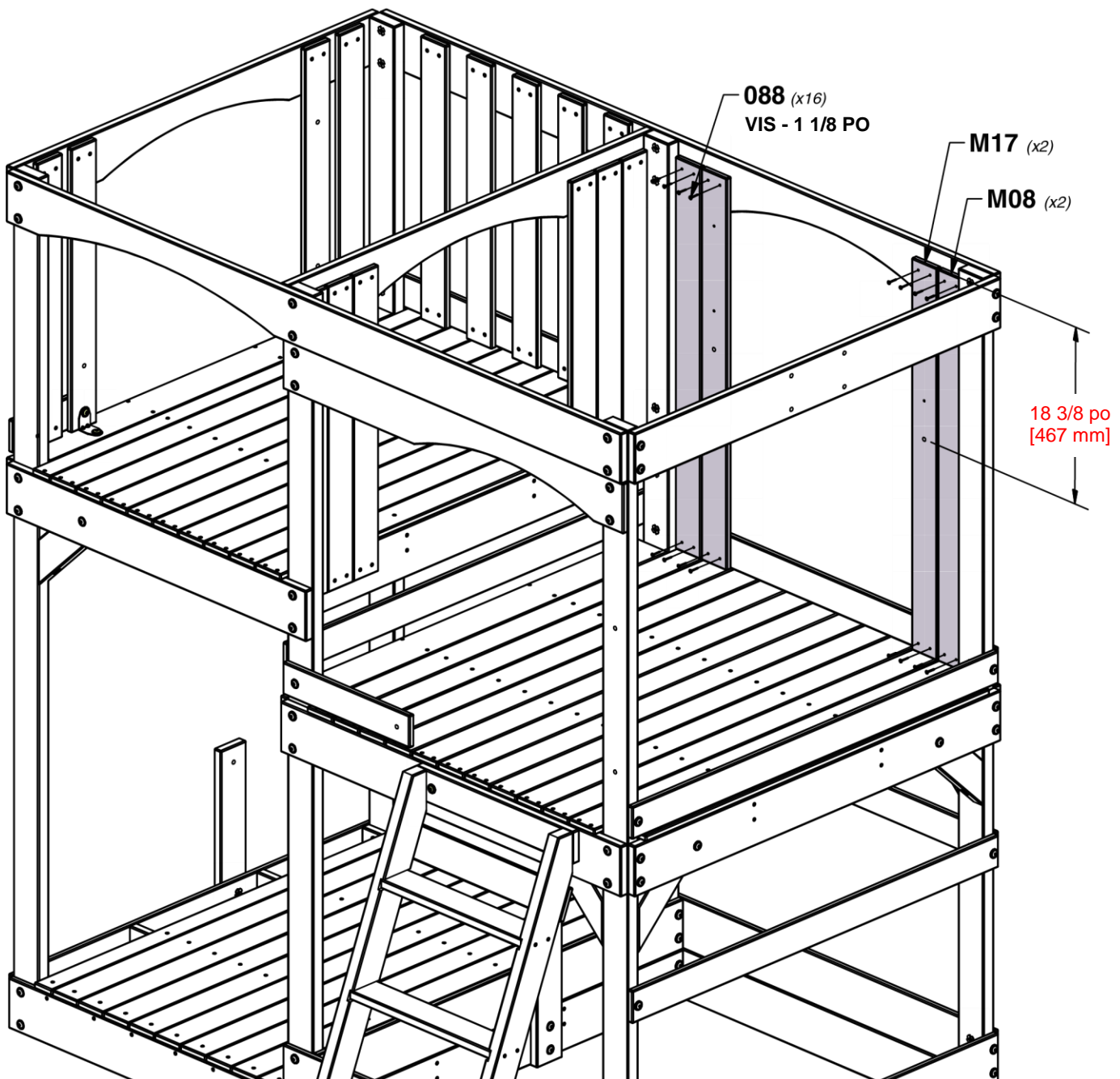

# ÉTAPE 21 - ASSEMBLAGE DU FORT



**M12** ENCADREMENT DE FENÊTRE - W4L16048  
(x1) 5/8 po x 3 3/8 po x 31 1/2 po (16 x 86 x 800)



**M13** PANNEAU MURAL - W4L16049  
(x7) 5/8 po x 3 3/8 po x 24 po (16 x 86 x 610)

QTÉ	NUMÉRO D'ARTICLE	DESCRIPTION
2	H100009	BOULON WH 5/16 x 1 1/4
2	H100030	RONDELLE DE VERROUILLAGE EXT 8 x 19
2	H100074	ÉCROU À ENFONCER 5/16
28	H100088	VIS TÊTE PLATE PFH 8 x 1-1/8 PO

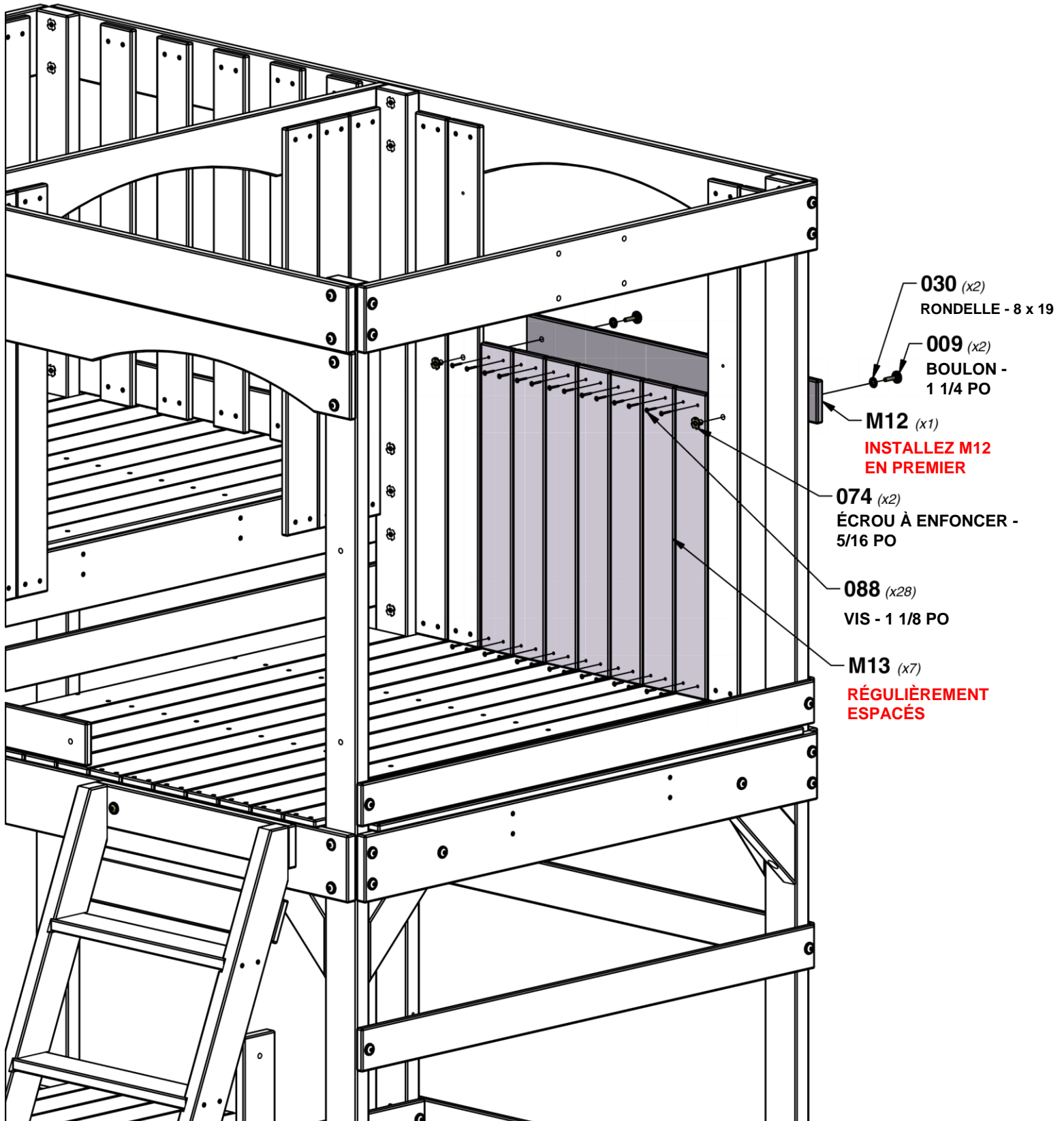

# ÉTAPE 22 - ASSEMBLAGE DU FORT

QTÉ	NUMÉRO D'ARTICLE	DESCRIPTION
4	H100088	VIS TÊTE PLATE PFH 8 x 1-1/8 PO

**M23** | ENCADREMENT DE FENÊTRE - W4L16059  
(x2) | 5/8 po x 3 3/8 po x 12 7/8 po (16 x 86 x 328)

## VUE LATÉRALE

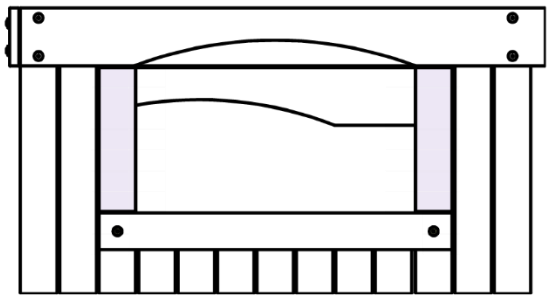

**ASSEMBLAGE CORRECT DES PLANCHES**

**088** (x4)  
VIS - 1 1/8 PO

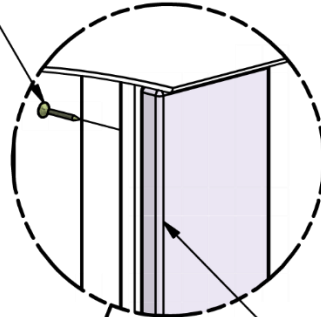

**M23** (x2)

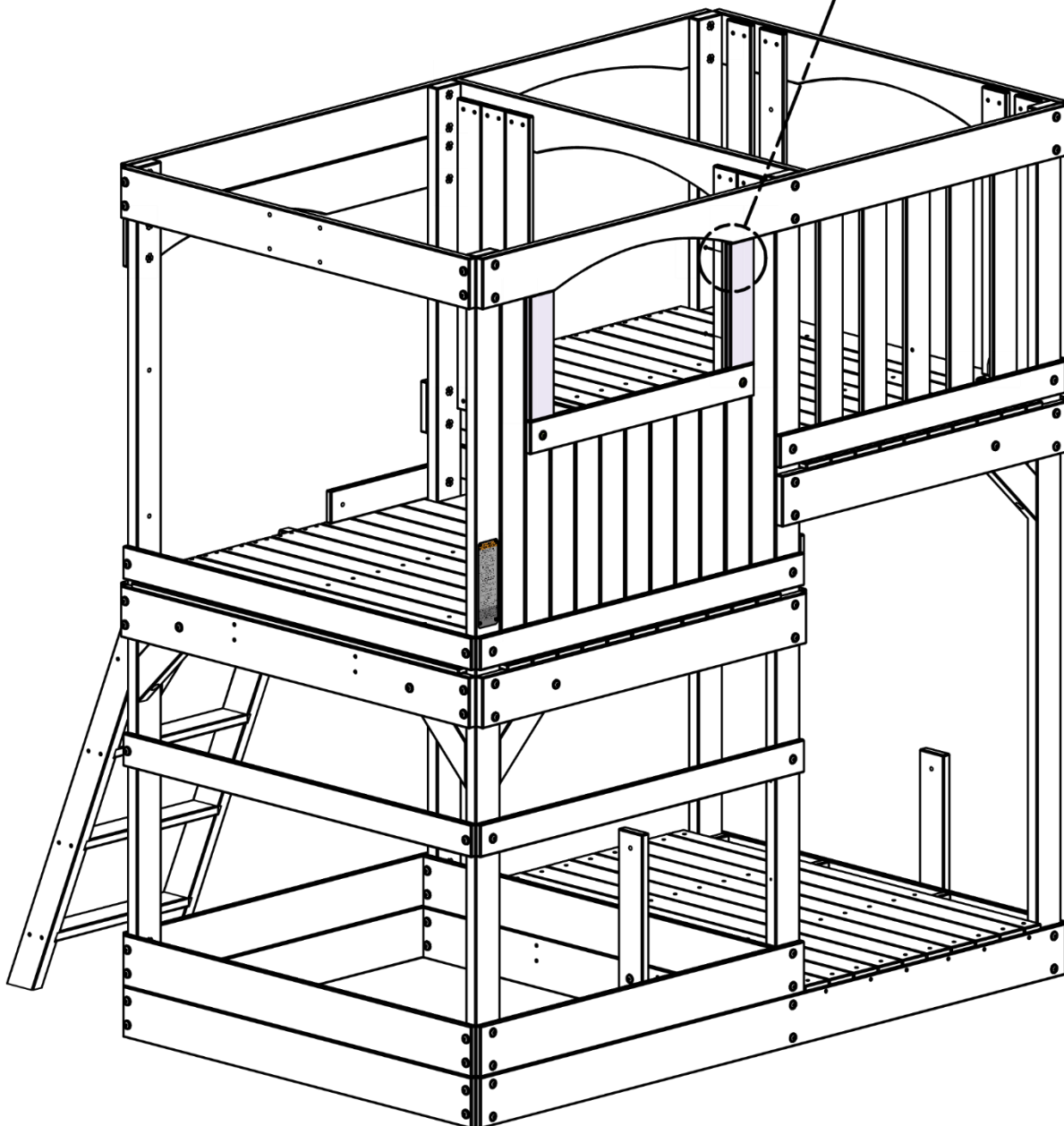

# ÉTAPE 23 - ASSEMBLAGE DU FORT

QTÉ	NUMÉRO D'ARTICLE	DESCRIPTION
48	H100086	VIS TÊTE PLATE PFH 8 x 1-1/8 PO

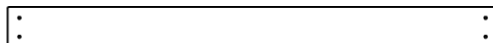

**M08** | PANNEAU MURAL - W4L16074  
(x7) | 5/8 po x 3 3/8 po x 41 po (16 x 86 x 1040)

**N03** | PANNEAU MURAL - W4L16078  
(x2) | 5/8 po x 2 3/8 po x 18 po (16 x 60 x 456)



**N05** | PANNEAU MURAL - W4L16080  
(x2) | 5/8 po x 2 3/8 po x 7 po (16 x 60 x 178)



**L02** | PANNEAU MURAL - W4L16040  
(x4) | 5/8 po x 4 3/8 po x 18 po (16 x 112 x 456)



**L03** | PANNEAU MURAL - W4L16041  
(x4) | 5/8 po x 4 3/8 po x 7 po (16 x 112 x 178)

**FAITES AFFLEURER LE DESSUS DES PLANCHES L03 ET N05 AVEC LE DESSUS DES PLANCHES M08**

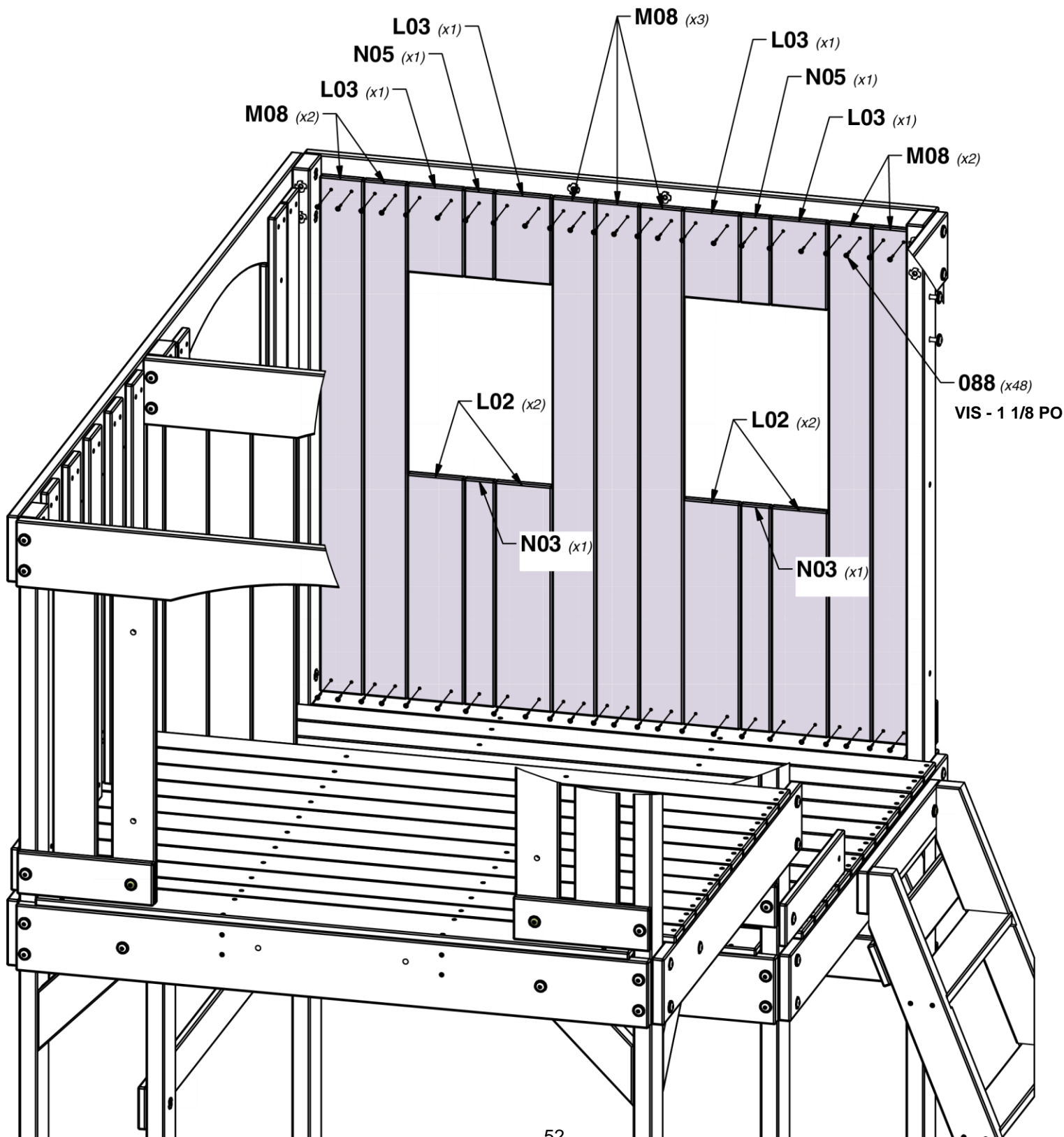

# ÉTAPE 24 - ASSEMBLAGE DU FORT

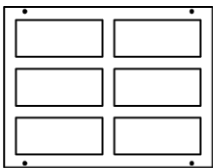

A100010 | FENÊTRE PLASTIQUE  
(x2) | BYD VERT 343x444.5



O01 | SUPPORT MURAL - W4L16081  
(x2) | 5/8 po x 1 3/8 po x 13 po (16 x 34 x 330)

QTÉ	NUMÉRO D'ARTICLE	DESCRIPTION
8	H100070	VIS TÊTE BOMBÉE CRUCIFORME PWH 8 x 3/4
10	H100088	VIS TÊTE PLATE PFH 8 x 1-1/8 PO

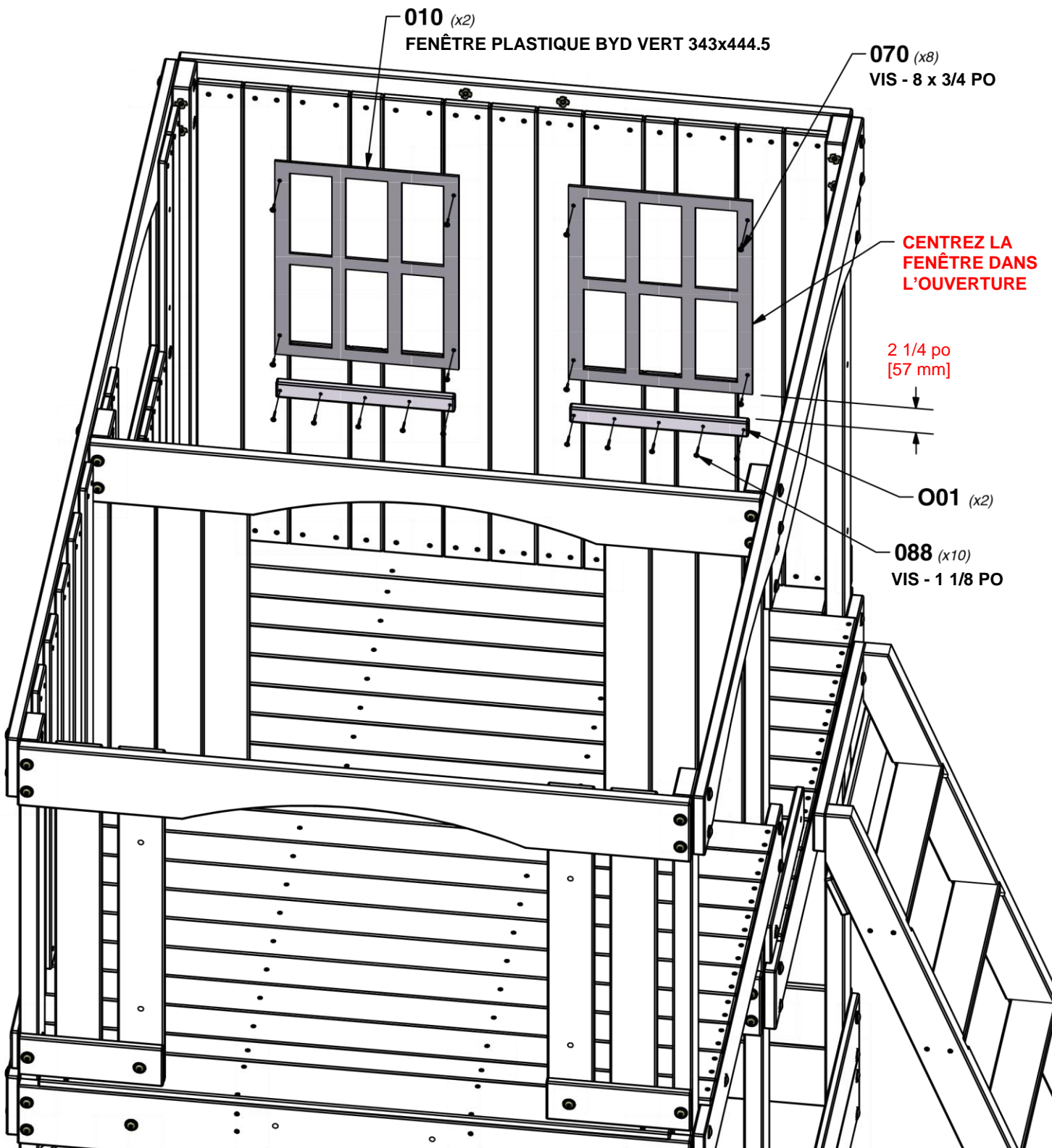

# ÉTAPE 25 - ASSEMBLAGE DU FORT

QTÉ	NUMÉRO D'ARTICLE	DESCRIPTION
12	H100086	VIS TÊTE PLATE PFH 8 x 1-1/2 PO

**O04** | LAME DE VOLET DE FENÊTRE - W4L16084  
 (x6) 5/8 po x 1 3/8 po x 5 3/8 po (16 x 34 x 136)

**L04** | VOLET DE FENÊTRE - W4L16042  
 (x3) 5/8 po x 4 3/8 po x 16 po (16 x 112 x 406)

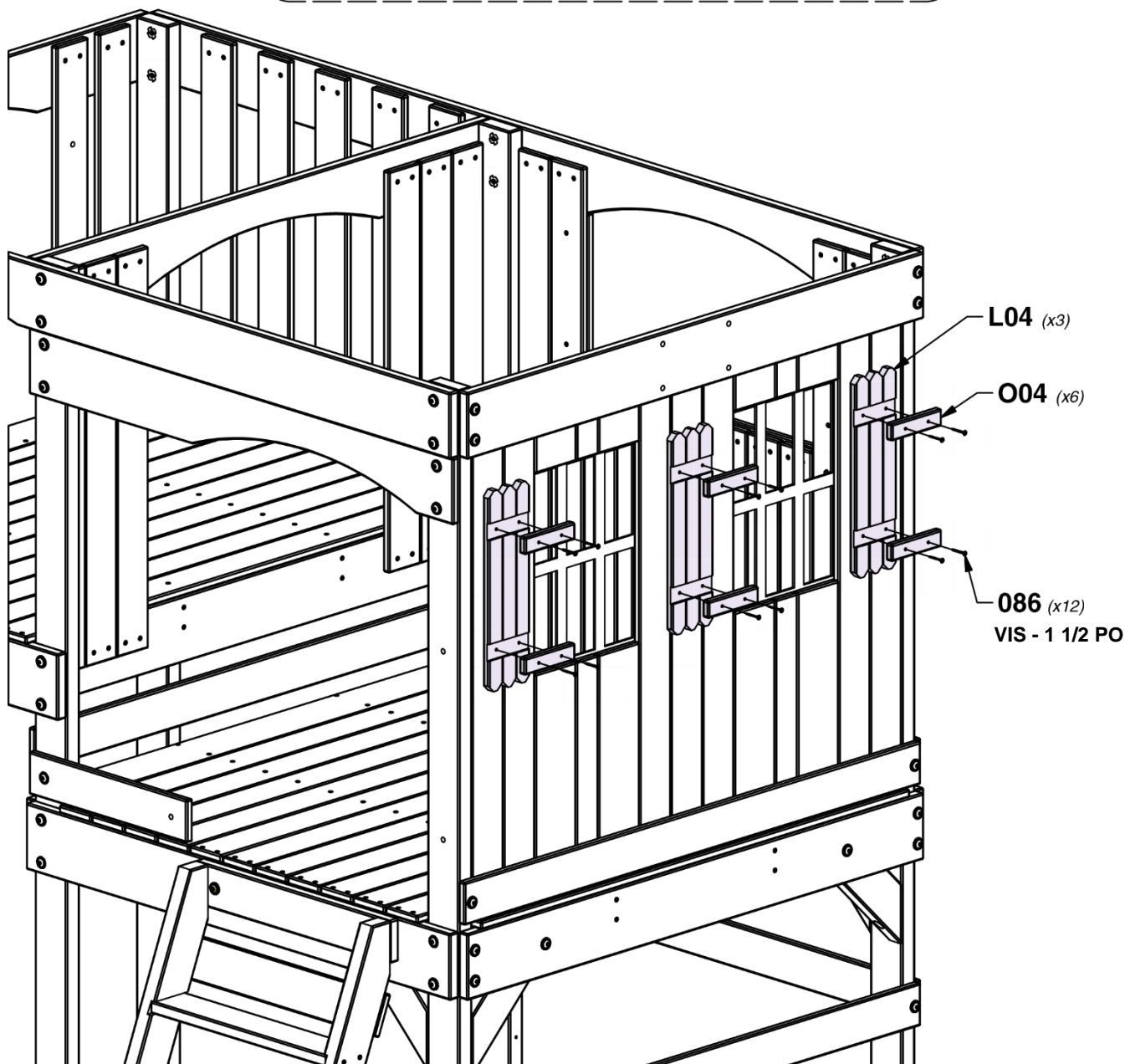
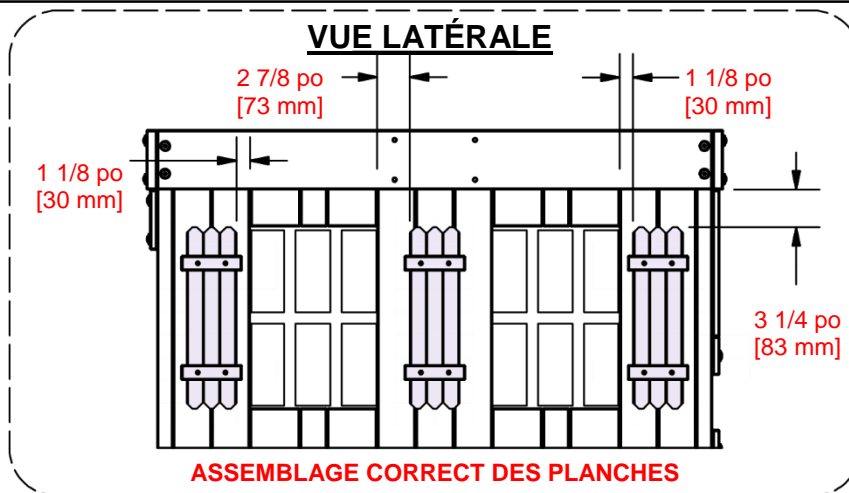

# ÉTAPE 26 - ASSEMBLAGE DU FORT



**M10** | PANNEAU MURAL - W4L16044  
(x1) 5/8 po x 3 3/8 po x 35 po (16 x 86 x 888)



**M28** | PANNEAU MURAL - W4L16064  
(x1) 5/8 po x 3 3/8 po x 35 po (16 x 86 x 888)



**A4M01046** | SUPPORT EN L  
(x1) 2,5 x 38 x 55 x 55



**M16** | PANNEAU MURAL - W4L16052  
(x2) 5/8 po x 3 3/8 po x 21 po (16 x 86 x 532)



**M29** | PANNEAU MURAL - W4L16060  
(x2) 5/8 po x 3 3/8 po x 5 po (16 x 86 x 126)

QTÉ	NUMÉRO D'ARTICLE	DESCRIPTION
1	H100088	ÉCROU À PORTÉE CYLINDRIQUE WH 5/16 x 7/8
1	H100088	BOULON WH 5/16 x 1
1	H100088	RONDELLE DE VERROUILLAGE EXT 12 x 19
1	H100088	ÉCROU À ENFONCER 5/16
14	H100088	VIS TÊTE PLATE PFH 8 x 1-1/8 PO
1	H100088	BOULON WH 5/16 x 1/2

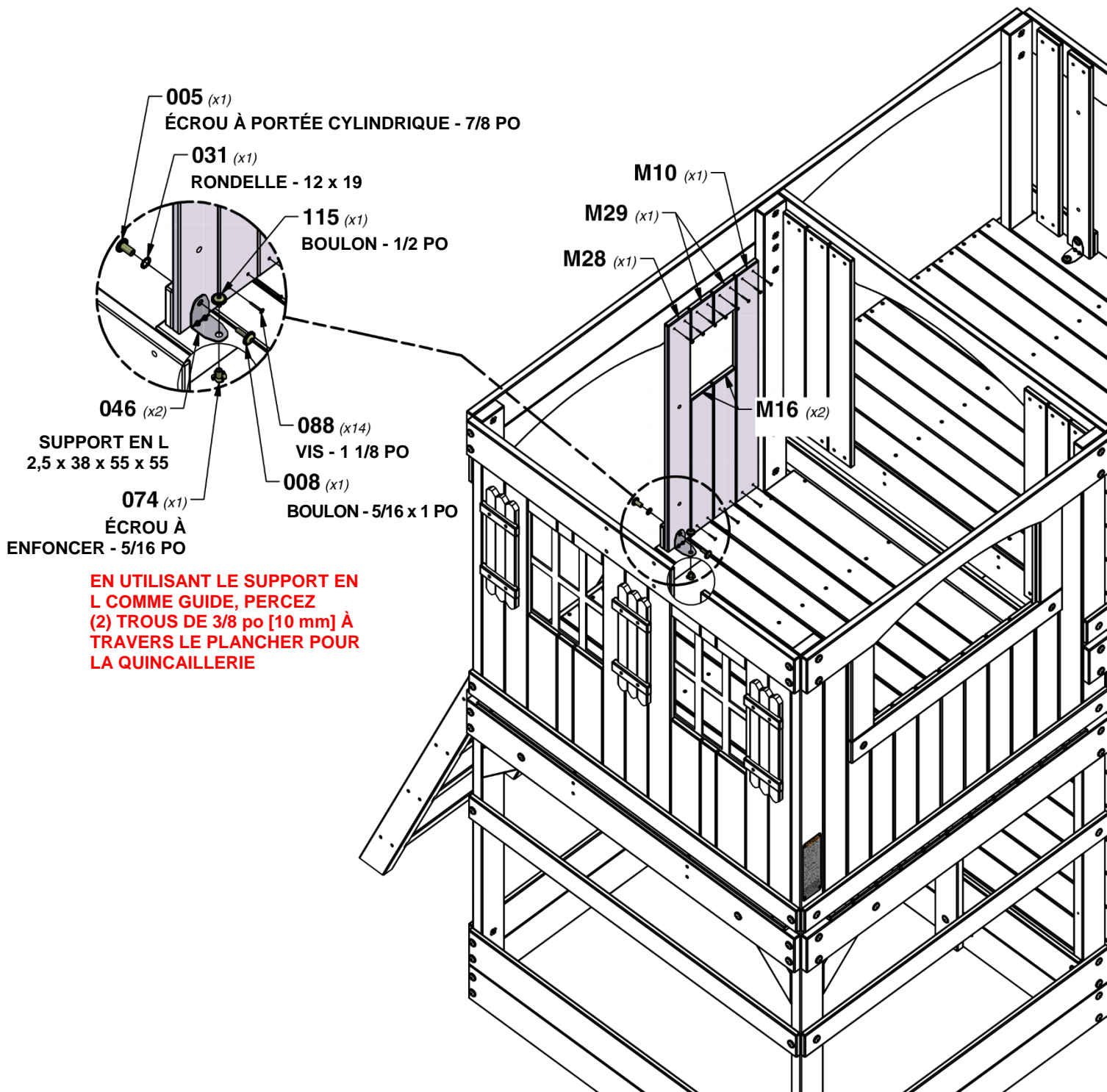

# ÉTAPE 27 - ASSEMBLAGE DU FORT

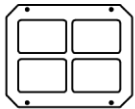

A100146 (x1) FENÊTRE  
216 x 267 VERTE

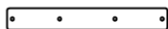

O02 (x1) SUPPORT MURAL - W4L16082  
(x1) 5/8 po x 1 3/8 po x 10 po (16 x 34 x 254)

QTÉ	NUMÉRO D'ARTICLE	DESCRIPTION
4	H100070	VIS TÊTE BOMBÉE CRUCIFORME PWH 8 x 3/4
4	H100088	VIS TÊTE PLATE PFH 8 x 1-1/8 PO

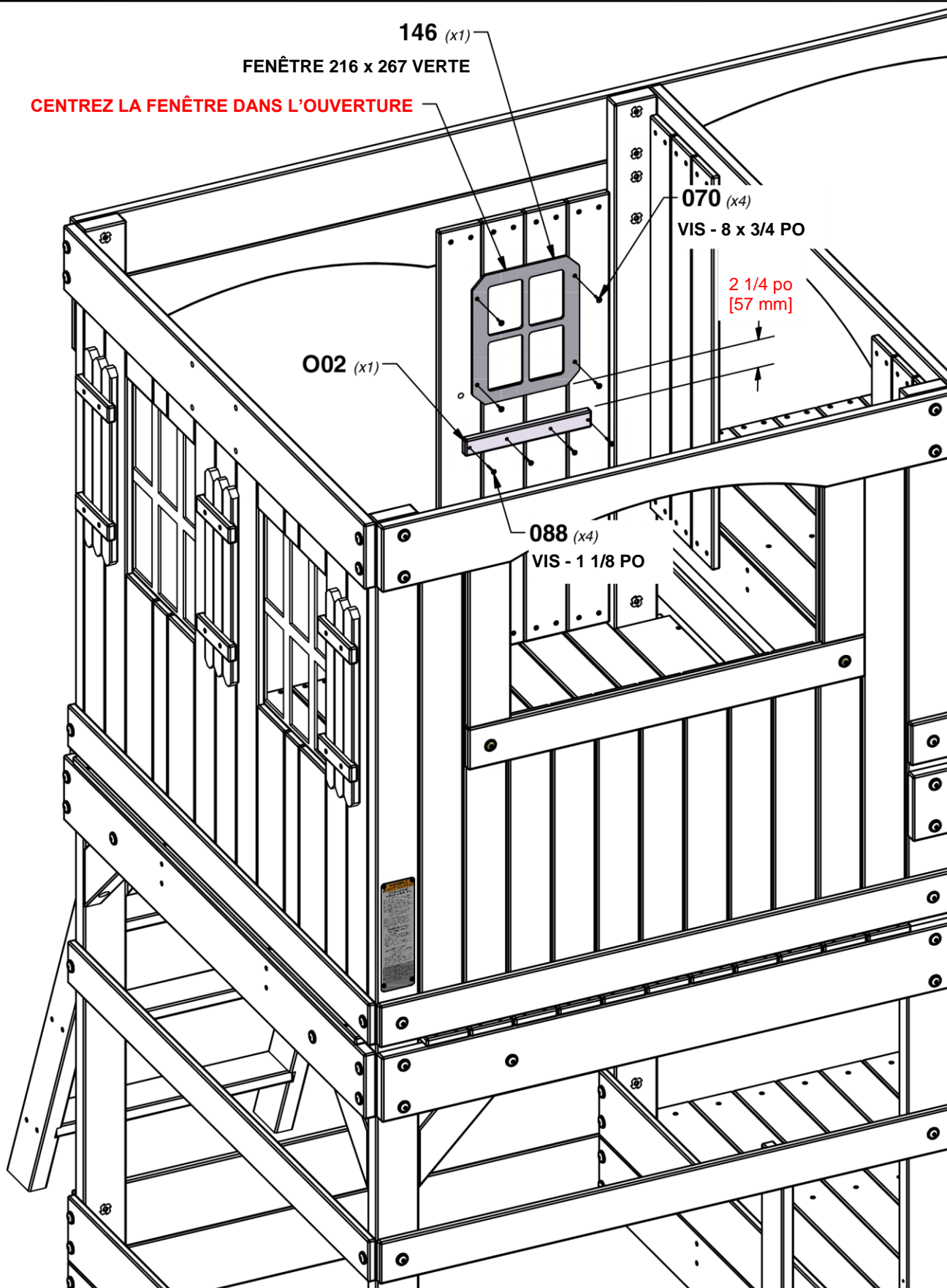

# ÉTAPE 28 - ASSEMBLAGE DU FORT



**M01** | CHAPEAU DU TOIT - W4L16043  
(x2) 5/8 po x 3 3/8 po x 51 7/8 po (16 x 86 x 1318)



**J01** | CHEVRON DE TOIT - W4L16033  
(x4) 1 po x 2 3/8 po x 33 5/8 (24 x 60 x 854)

QTÉ	NUMÉRO D'ARTICLE	DESCRIPTION
8	H100086	VIS TÊTE PLATE PFH 8 x 1-1/2 PO
2	H100111	VIS TÊTE PLATE PFH 8 x 2

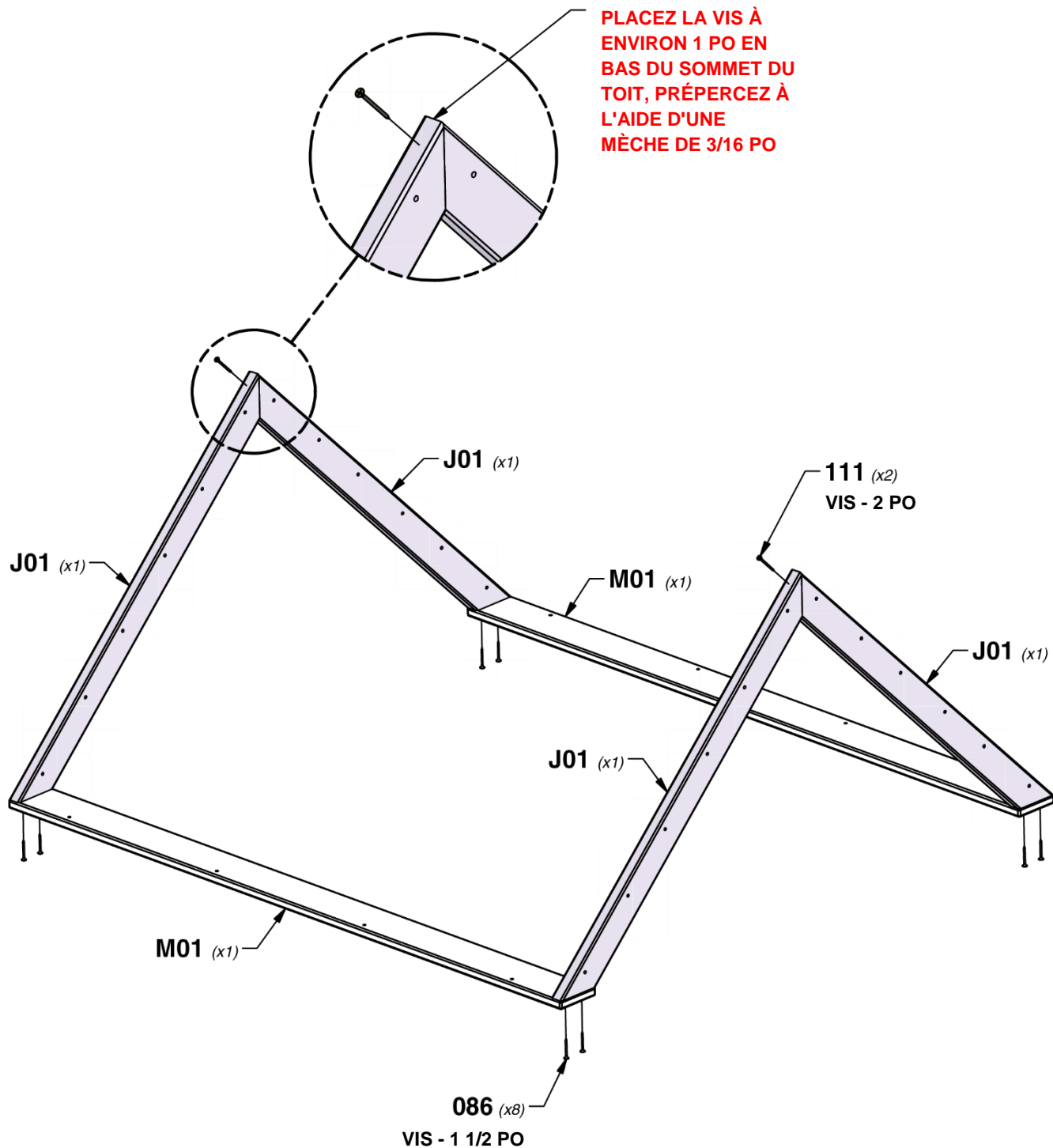

# ÉTAPE 29 - ASSEMBLAGE DU FORT

QTÉ	NUMÉRO D'ARTICLE	DESCRIPTION
8	H100090	VIS TÊTE PLATE PFH 8 x 2 1/2



ASSEMBLAGE DE LA BASE DU TOIT

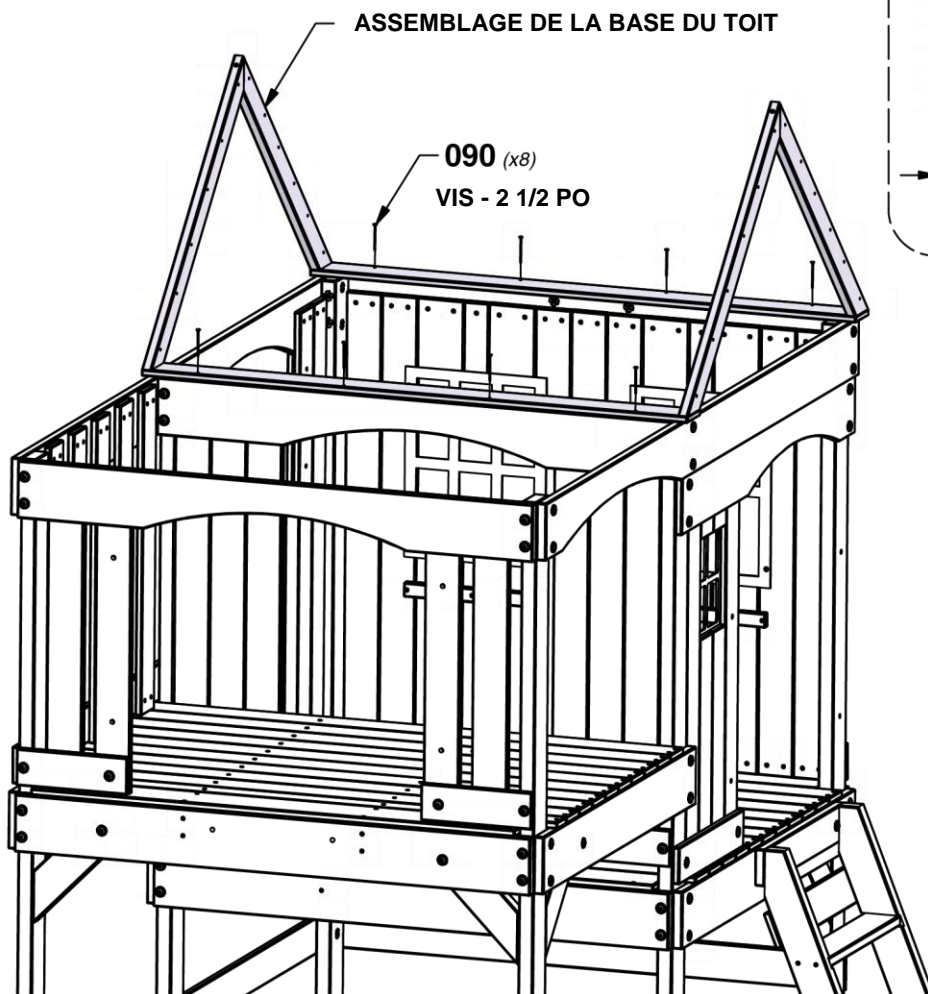
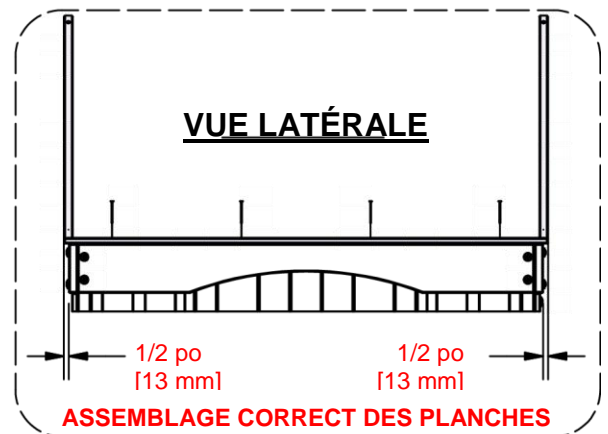
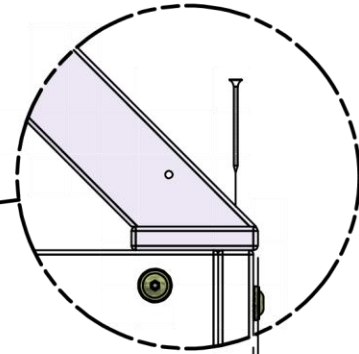
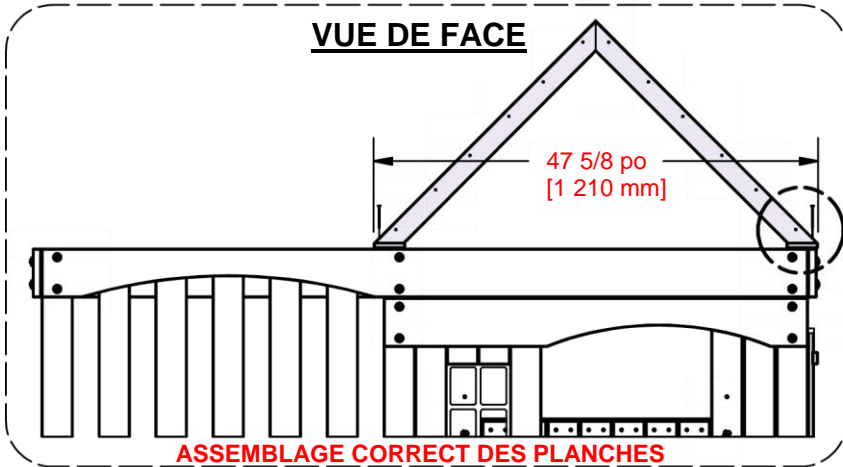

# ÉTAPE 30 - ASSEMBLAGE DU FORT

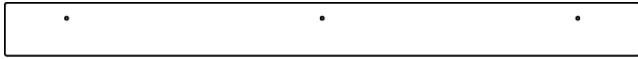

**M07** | CHAPEAU DU MUR - W4L16068  
(x2) 5/8 po x 3 3/8 po x 40 7/8 po (16 x 86 x 1038)

QTÉ	NUMÉRO D'ARTICLE	DESCRIPTION
6	H100090	VIS TÊTE PLATE PFH 8 x 2 1/2

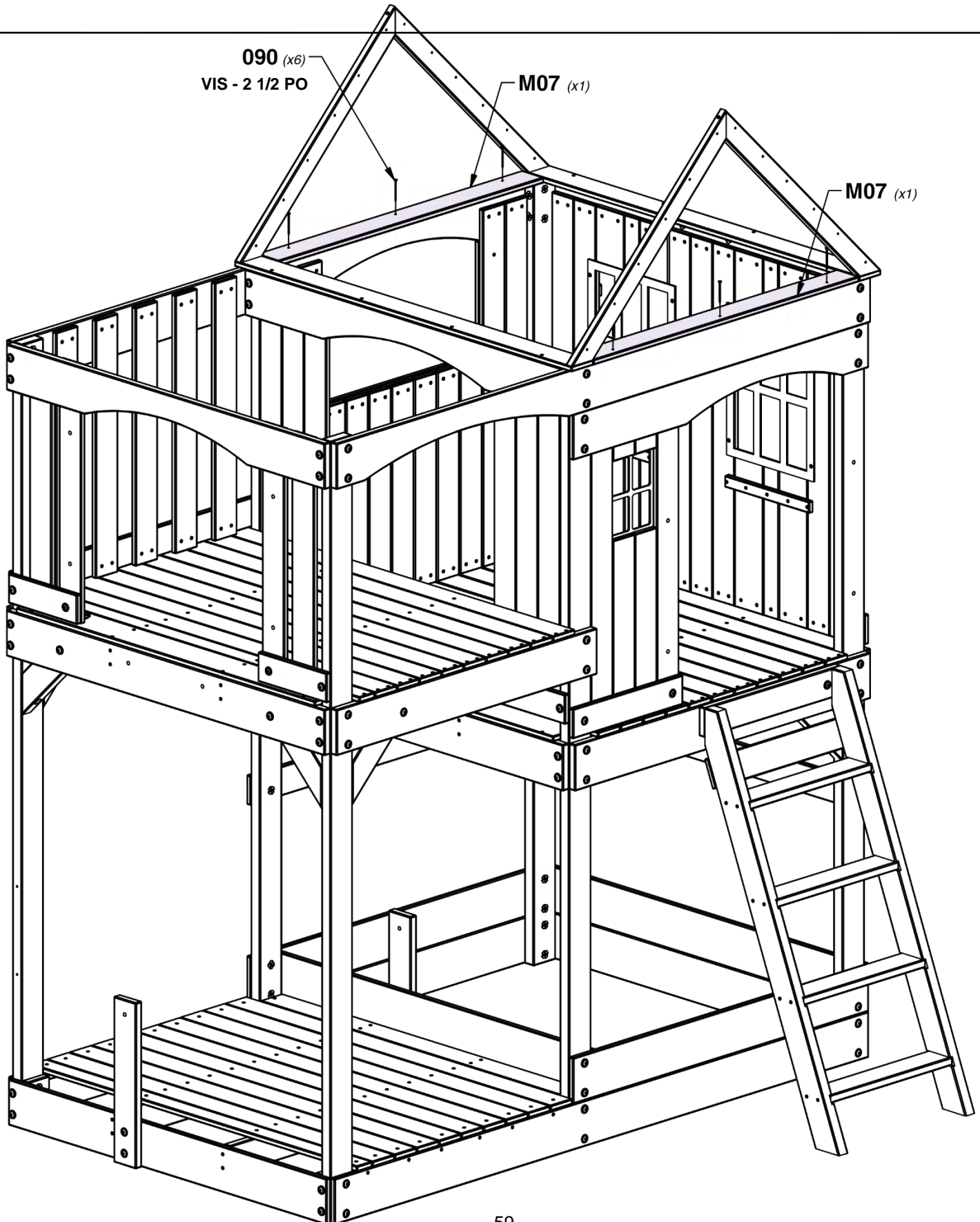

# ÉTAPE 31 - ASSEMBLAGE DU FORT

QTÉ	NUMÉRO D'ARTICLE	DESCRIPTION
22	H100088	VIS TÊTE PLATE PFH 8x1-1/8 PO

**M19** | PLANCHE DE RIVE DU PIGNON - W4L16054  
(x2) 5/8 po x 3 3/8 po x 15 1/4 po (16 x 86 x 387)

**M22** | PLANCHE DE RIVE DU PIGNON - W4L16058  
(x2) 5/8 po x 3 3/8 po x 9 1/2 po (16 x 86 x 241)

**N04** | PLANCHE DE RIVE DU PIGNON - W4L16079  
(x2) 5/8 po x 2 3/8 po x 11 7/8 po (16 x 60 x 301)

**M04** | PLANCHE DE RIVE DU PIGNON - W4L16065  
(x1) 5/8 po x 3 3/8 po x 44 po (16 x 86 x 1118)

**M20** | PLANCHE DE RIVE DU PIGNON - W4L16056  
(x1) 5/8 po x 3 3/8 po x 12 1/4 po (16 x 86 x 310)

**M15** | PLANCHE DE RIVE DU PIGNON - W4L16051  
(x1) 5/8 po x 3 3/8 po x 19 po (16 x 86 x 482)

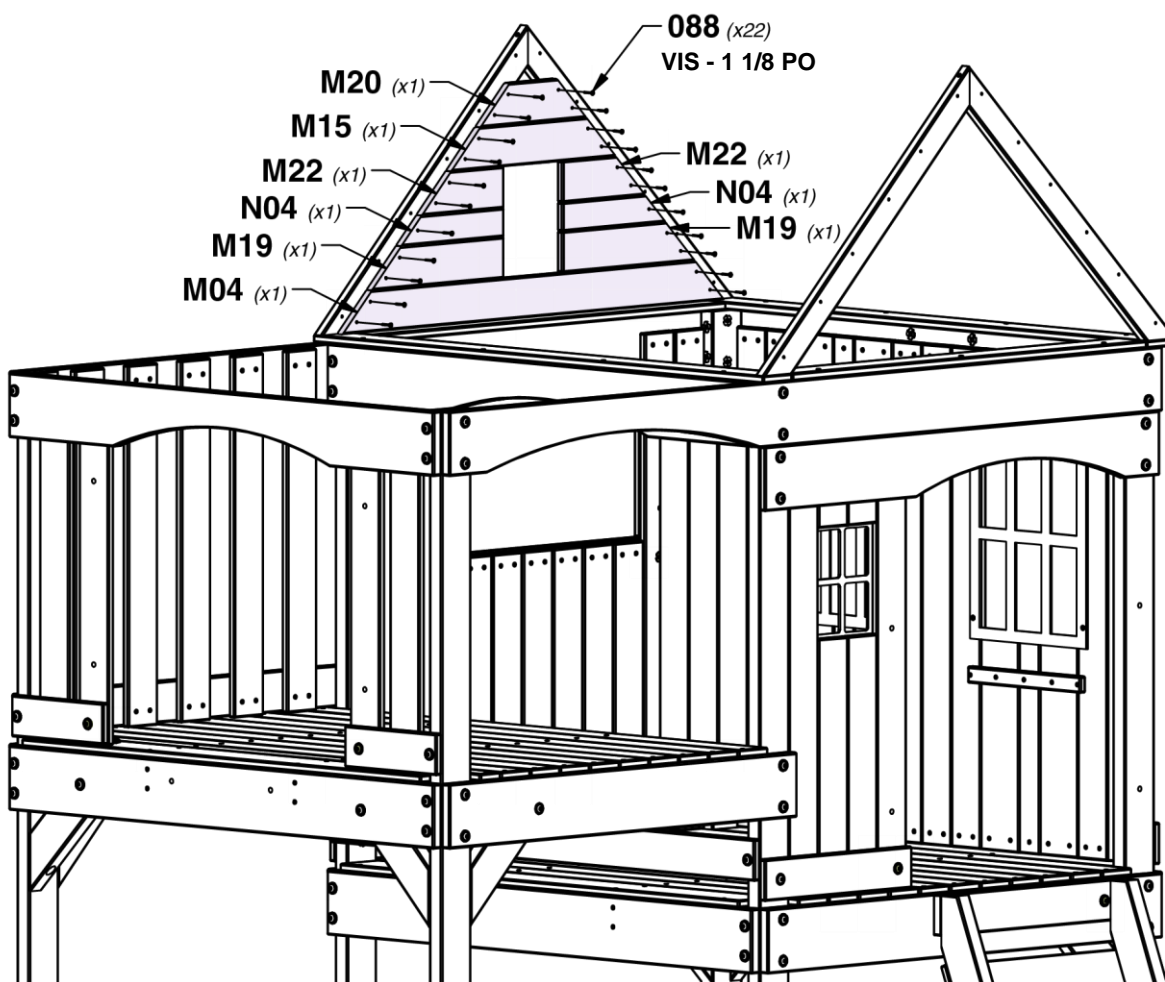
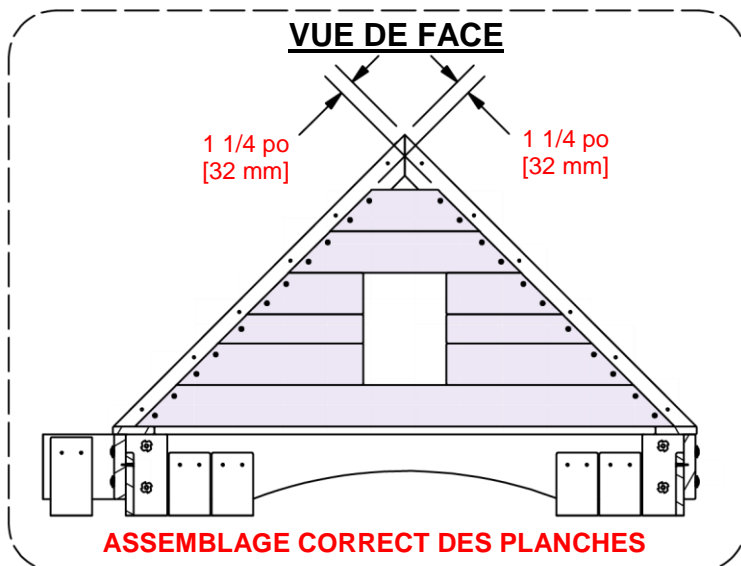

# ÉTAPE 32 - ASSEMBLAGE DU FORT

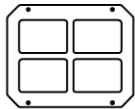

A100146 | FENÊTRE  
(x2) | 216 x 267 VERTE



O01 | SUPPORT MURAL - W4L16081  
(x4) | 5/8 po x 1 3/8 po x 13 po (16 x 34 x 330)

QTÉ	NUMÉRO D'ARTICLE	DESCRIPTION
8	H100070	VIS TÊTE BOMBÉE CRUCIFORME PWH 8 x 3/4
20	H100088	VIS TÊTE PLATE PFH 8 x 1-1/8 PO

## VUE DE FACE

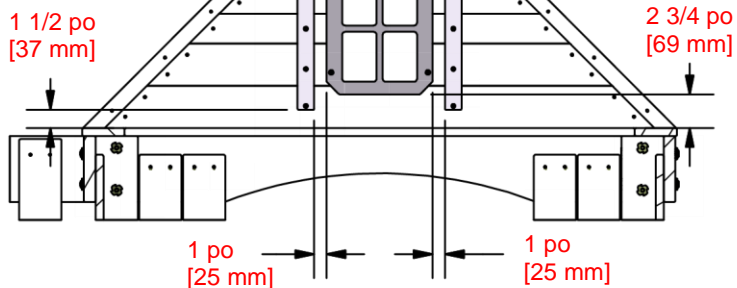

ASSEMBLAGE CORRECT

RÉPÉTEZ LES ÉTAPES 31 ET 32 SUR LE CÔTÉ OPPOSÉ.

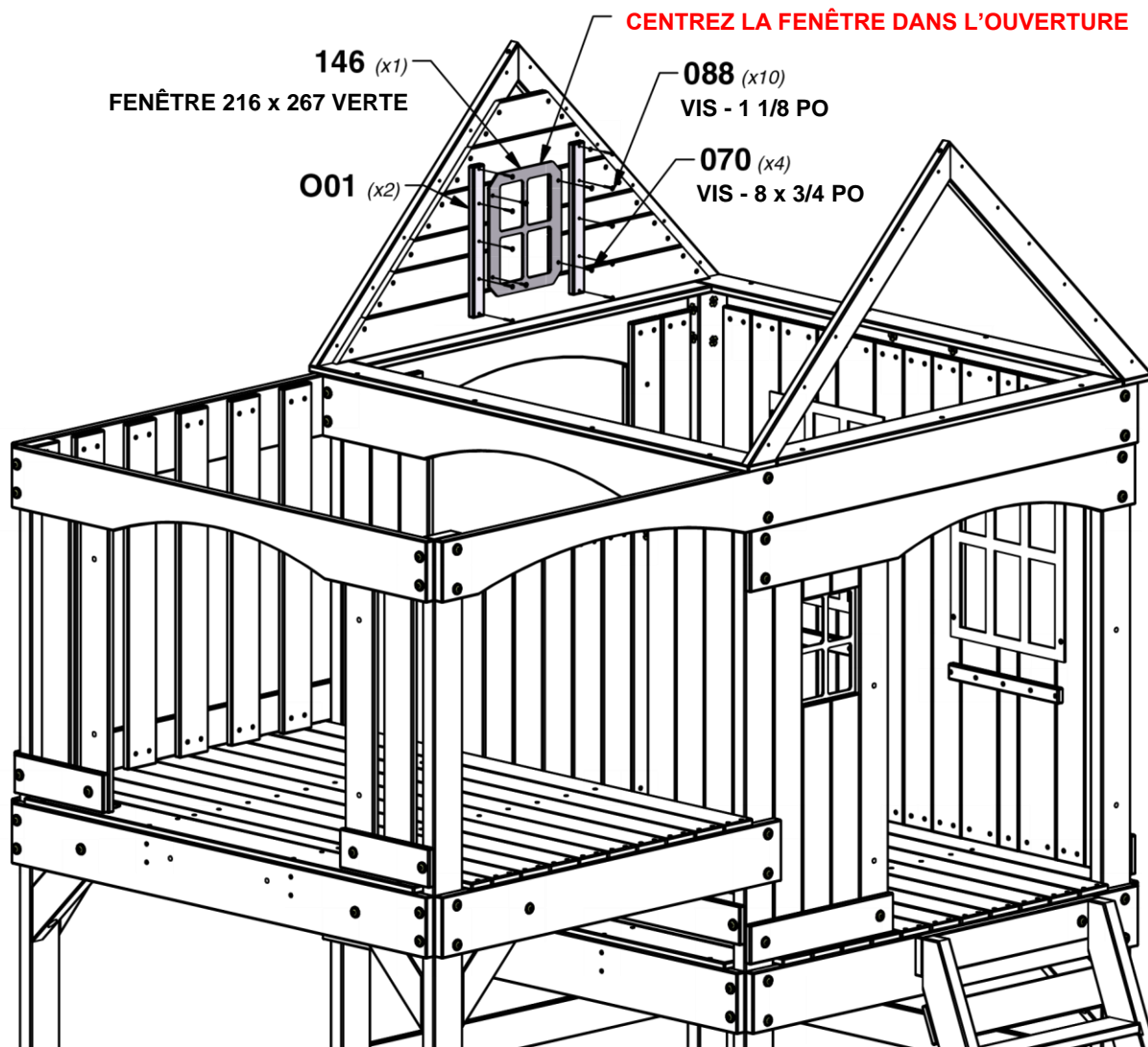

# ÉTAPE 33 - ASSEMBLAGE DU FORT

QTÉ	NUMÉRO D'ARTICLE	DESCRIPTION
24	H100089	VIS TÊTE PLATE PFH 8 x 1-3/4 PO

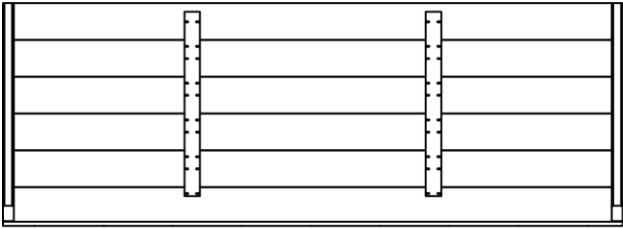

**RP1** | PANNEAU DE TOIT - W2A03279  
(x2) 1 3/4 po x 19 1/4 po x 53 3/4 po (45 x 490 x 1366)

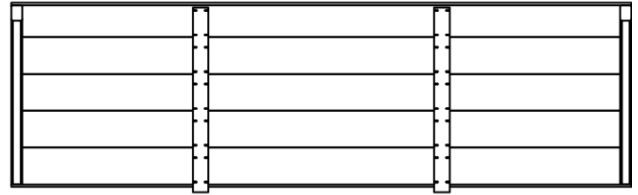

**RP2** | PANNEAU DE TOIT - W2A03280  
(x2) 1 3/4 po x 16 1/4 po x 53 3/4 po (45 x 417 x 1366)

**RÉPÉTEZ CETTE ÉTAPE POUR LE CÔTÉ OPPOSÉ.**

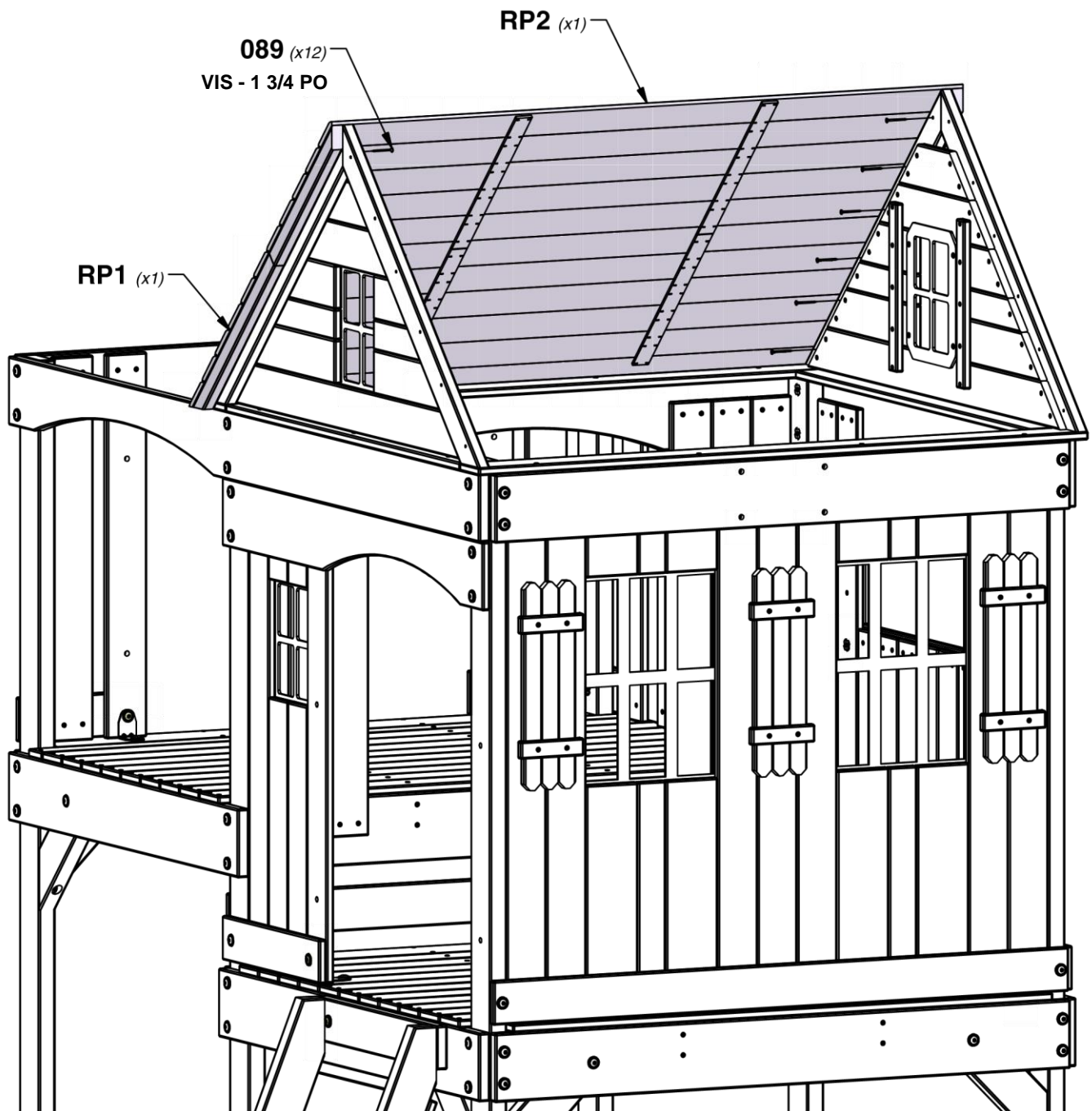

# ÉTAPE 34 - ASSEMBLAGE DU FORT

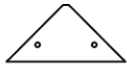

**N02** | PLAQUE DE REPRISE - W4L16077  
(x2) | 5/8 po x 2 3/8 po x 5 po (16 x 60 x 126)

QTÉ	NUMÉRO D'ARTICLE	DESCRIPTION
4	H100088	VIS TÊTE PLATE PFH 8 x 1-1/8 PO

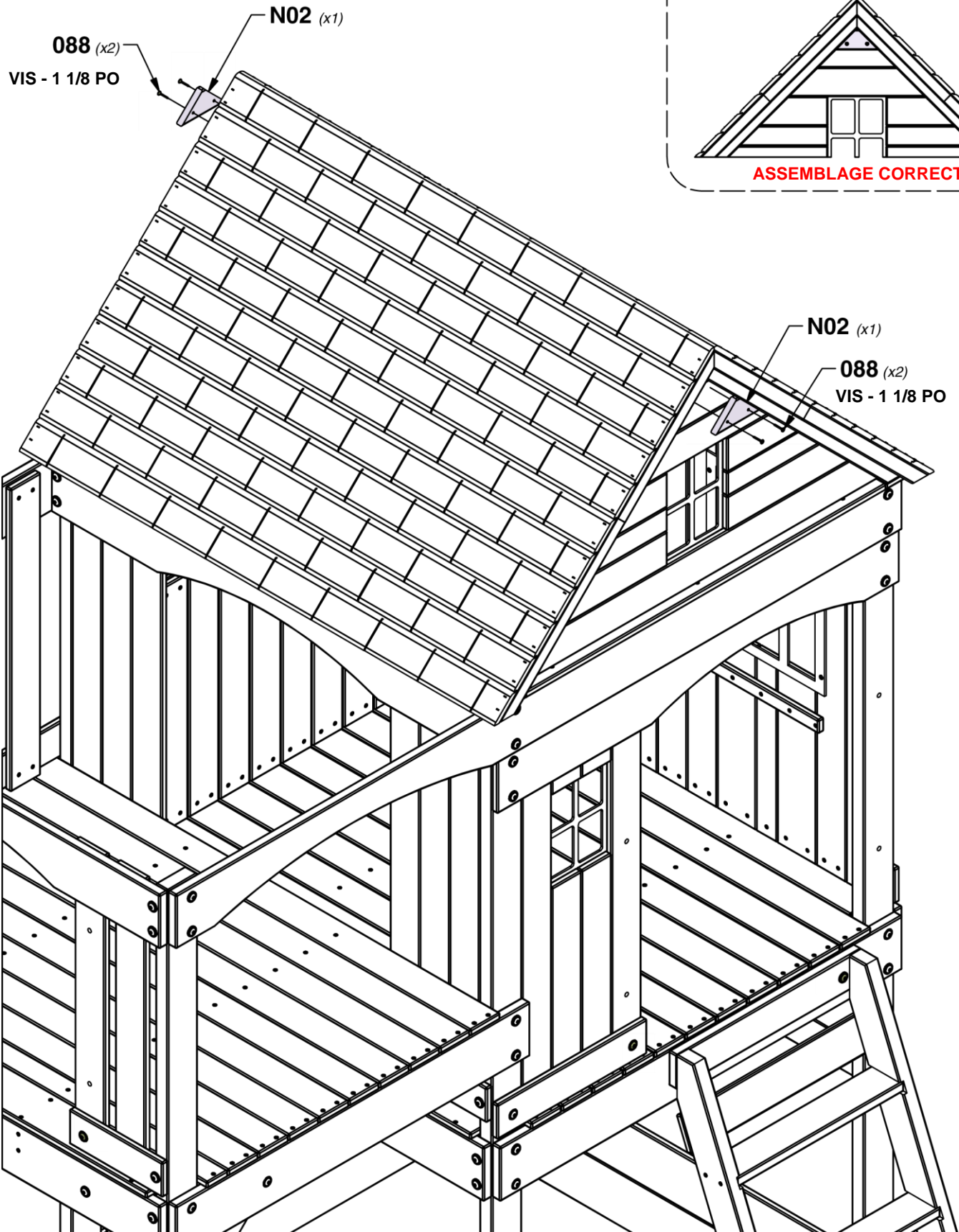

# ÉTAPE 35 - ASSEMBLAGE DU FORT

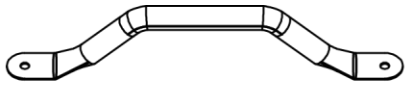

A100118 | POIGNÉE VERT  
(x4) | MÉTALLIQUE  
381 c/c

QTÉ	NUMÉRO D'ARTICLE	DESCRIPTION
2	H100111	BOULON WH 5/16 x1 1/2
8	H100111	ÉCROU À ENFONCER 5/16
6	H100111	BOULON WH 5/16 x 1/2

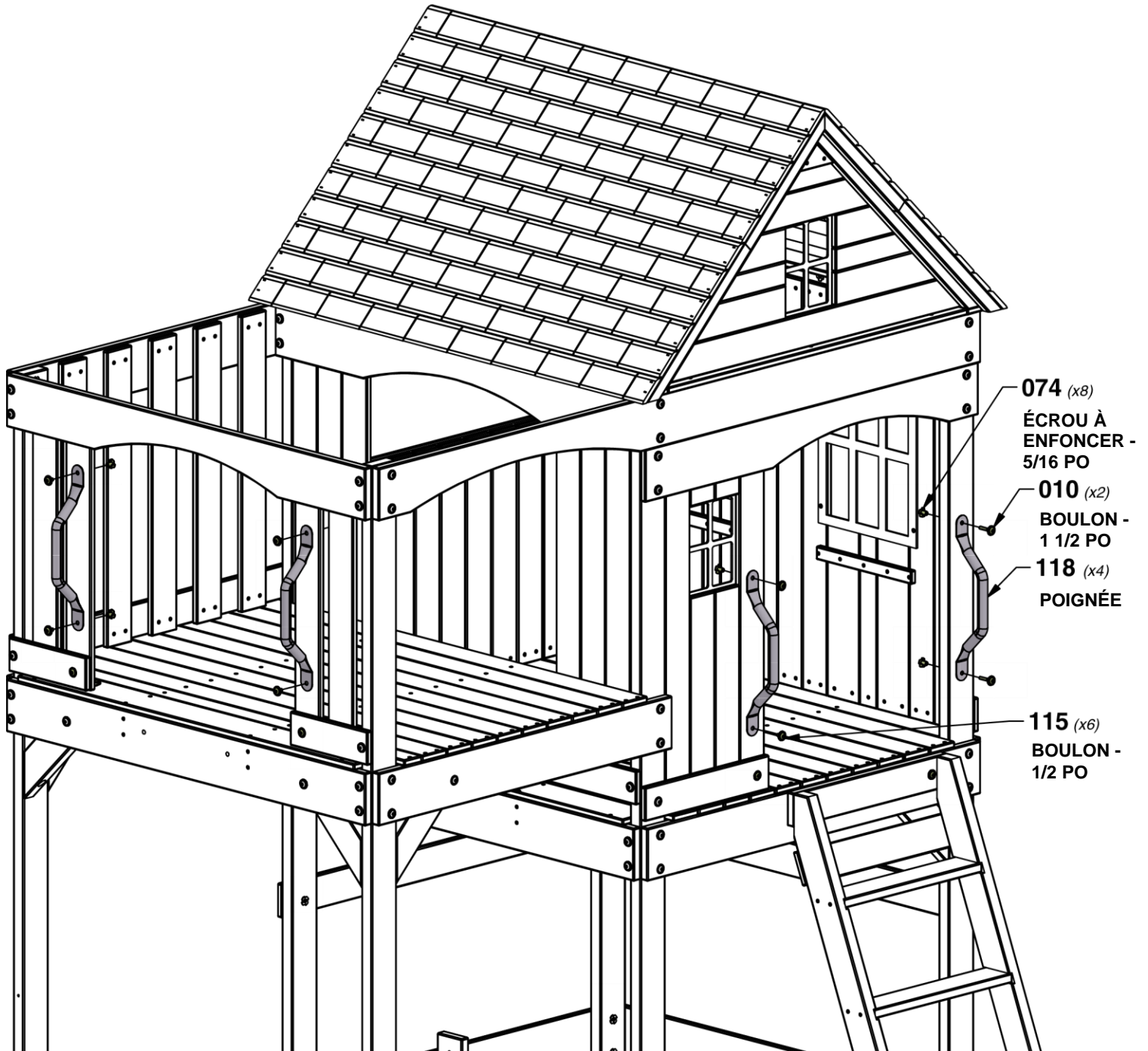

# ÉTAPE 36 - ASSEMBLAGE DU FORT

QTÉ	NUMÉRO D'ARTICLE	DESCRIPTION
8	H100186	VIS TÊTE PLATE PFH 8 x 1-1/2 PO



**T01** SUPPORT DE SIÈGE - W4L16086  
(x4) 1 po x 1 3/8 po x 4 3/8 po (24 x 34 x 112)

## VUES DES EMPLACEMENTS

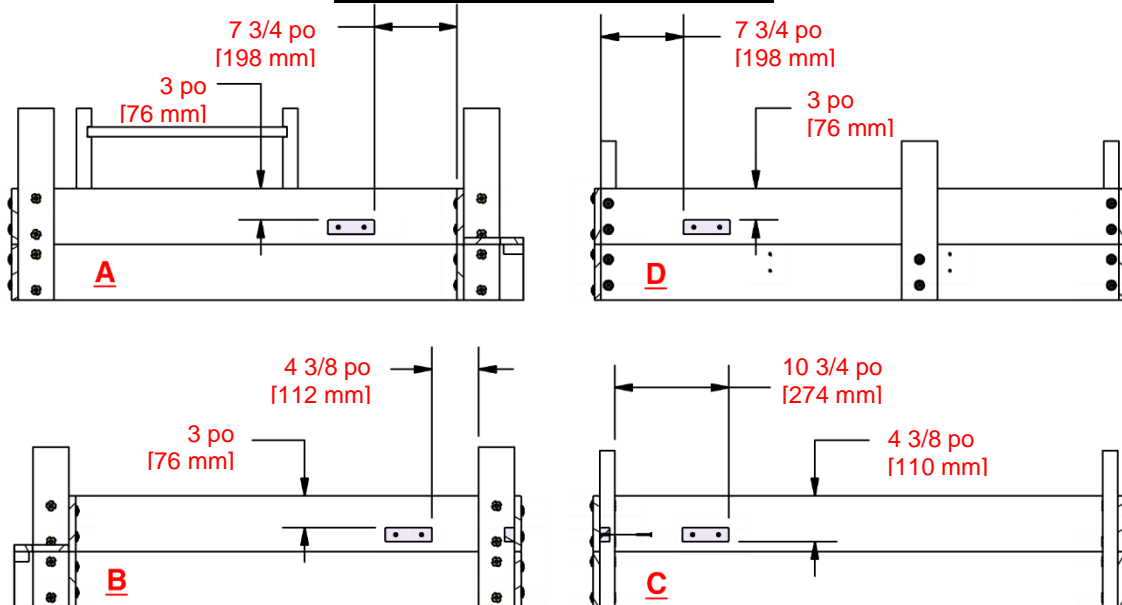

VOIR LES EMPLACEMENTS CI-DESSOUS (A, B, C et D)

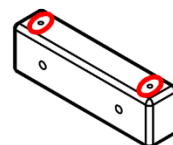

INSTALLEZ T01  
AVEC LES PETITS  
AVANT-TROUS  
VERS LE HAUT

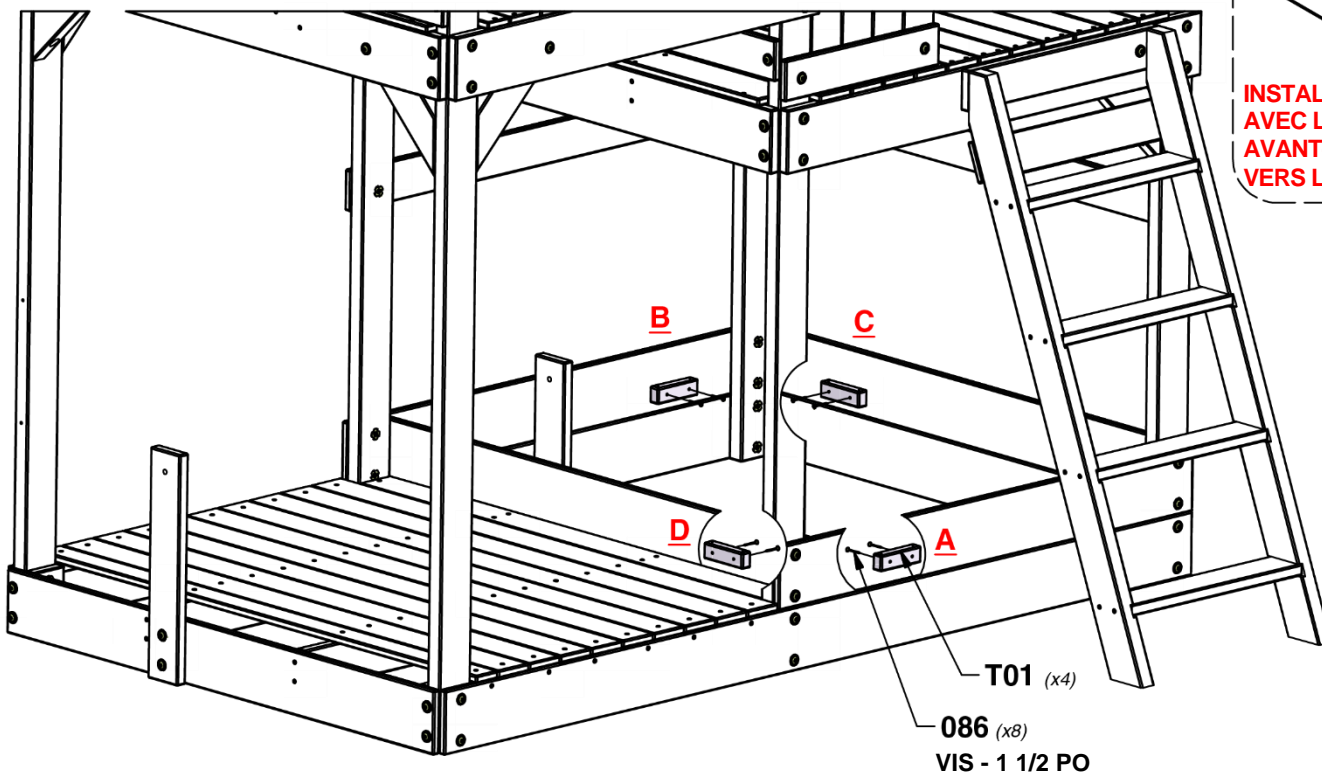

# ÉTAPE 37 - ASSEMBLAGE DU FORT

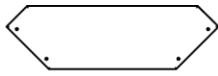

**G13** | SIÈGE DE BAC À SABLE - W4L16013  
(x2) | 1 po x 5 1/4 po x 17 3/4 po (24 x 134 x 450)

QTÉ	NUMÉRO D'ARTICLE	DESCRIPTION
8	H100089	VIS TÊTE PLATE PFH 8 x 1-3/4 PO

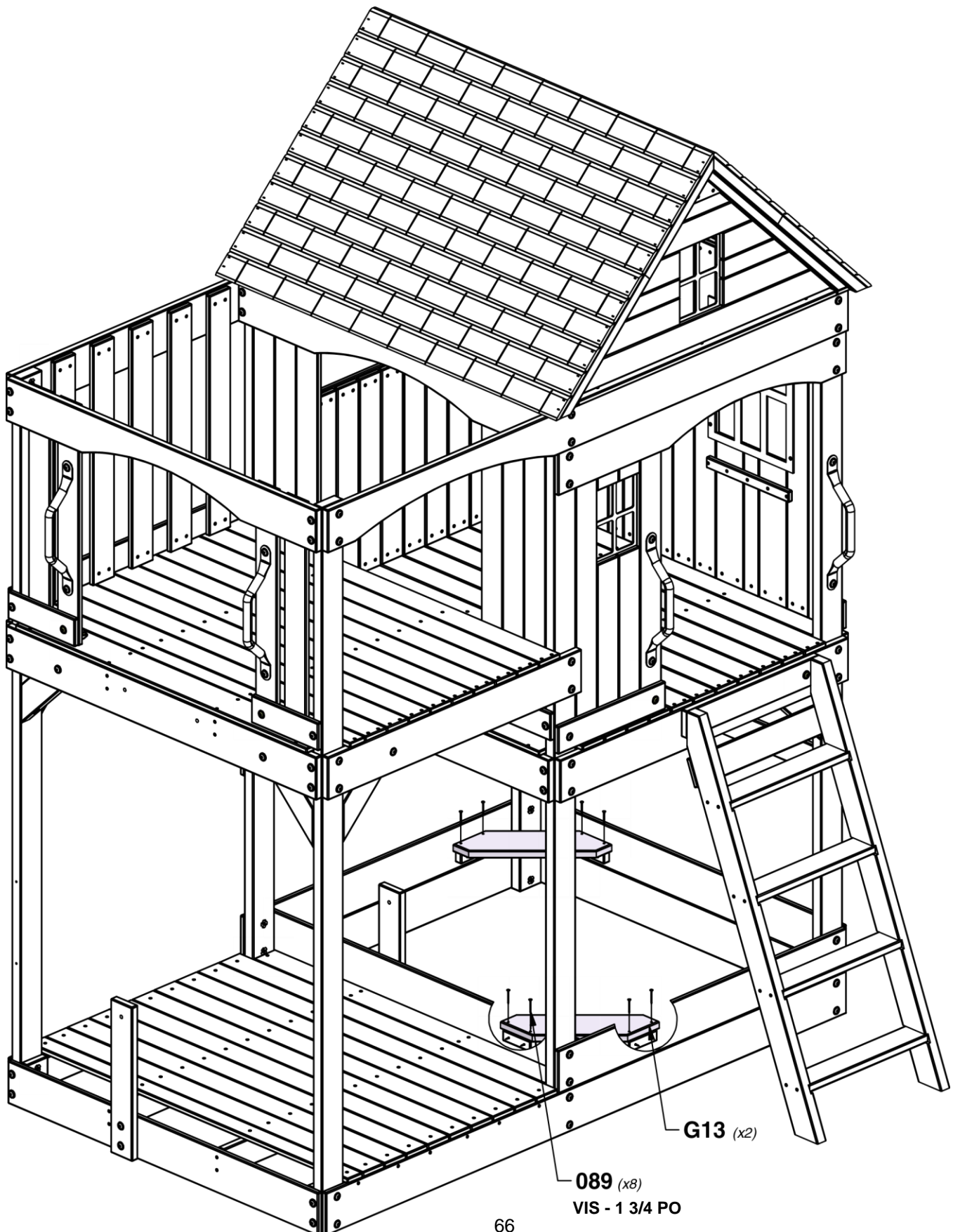

# ÉTAPE 38 - ASSEMBLAGE DU FORT

QTÉ	NUMÉRO D'ARTICLE	DESCRIPTION
24	H100088	VIS TÊTE PLATE PFH 8 x 1-1/8 PO

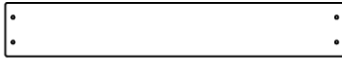

**M27** | PANNEAU MURAL INFÉRIEUR - W4L16062  
(x6)  
5/8 po x 3 3/8 po x 21 3/8 po (16 x 86 x 544)

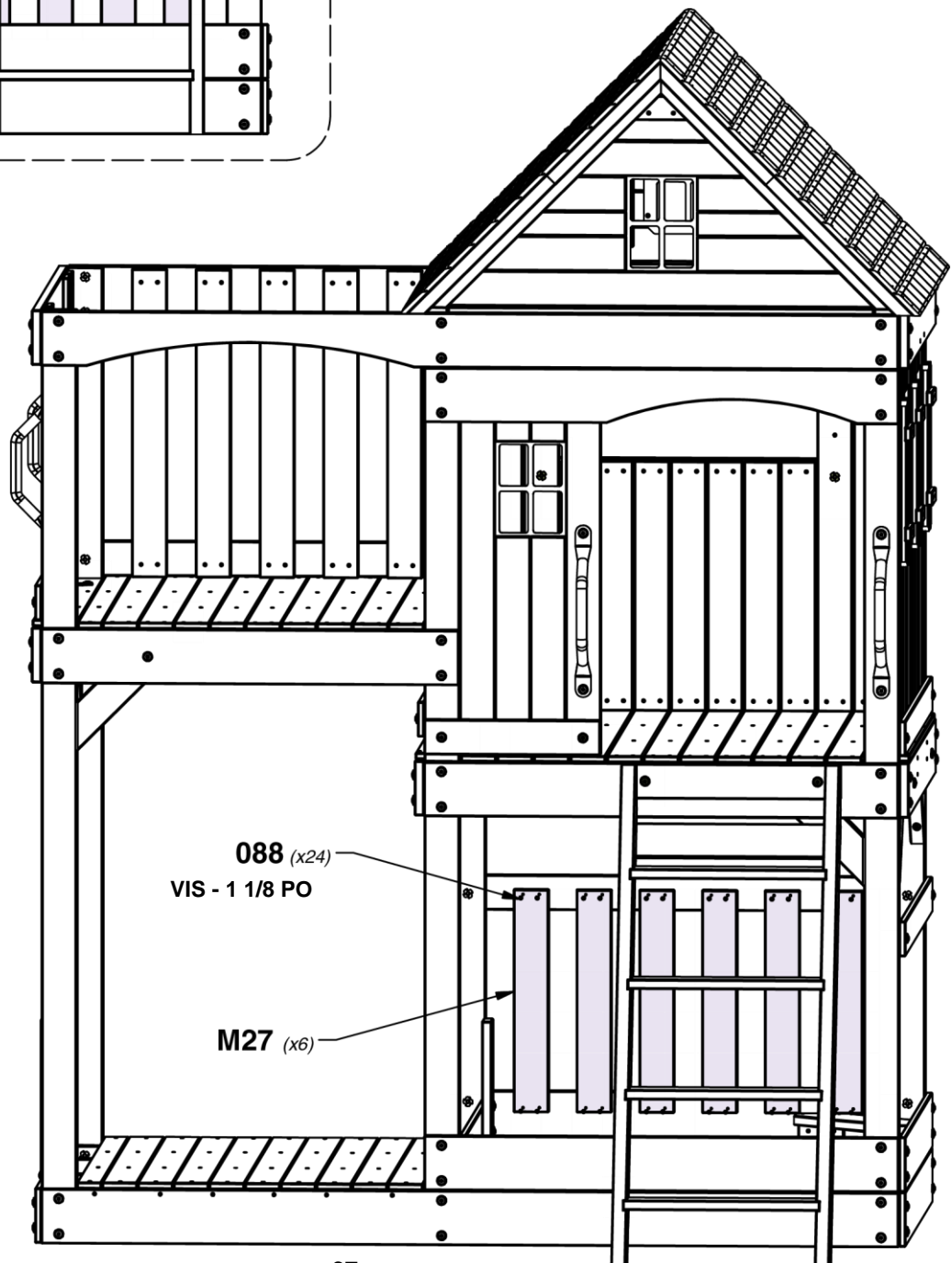
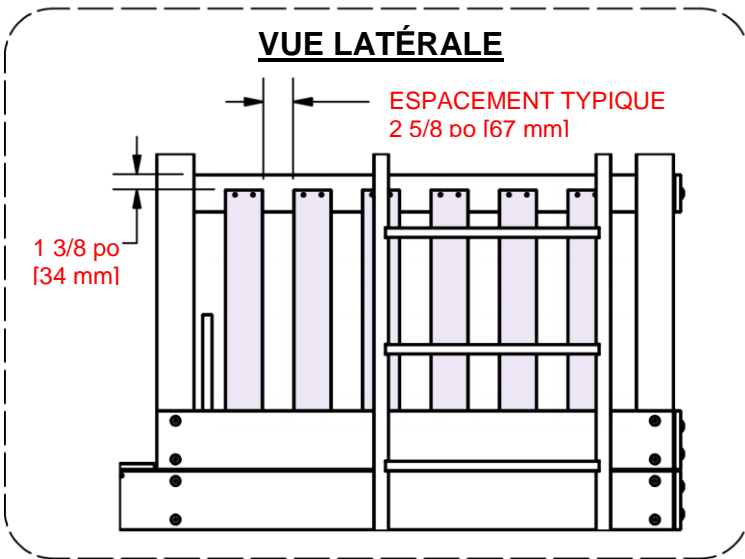

# ÉTAPE 39 - ASSEMBLAGE DU FORT



**M27** | PANNEAU MURAL INFÉRIEUR - W4L16062  
(x7) | 5/8 po x 3 3/8 po x 2 1/8 po (16 x 86 x 54)

QTÉ	NUMÉRO D'ARTICLE	DESCRIPTION
28	H100028	VIS TÊTE PLATE PFH 8 x 1-1/8 PO

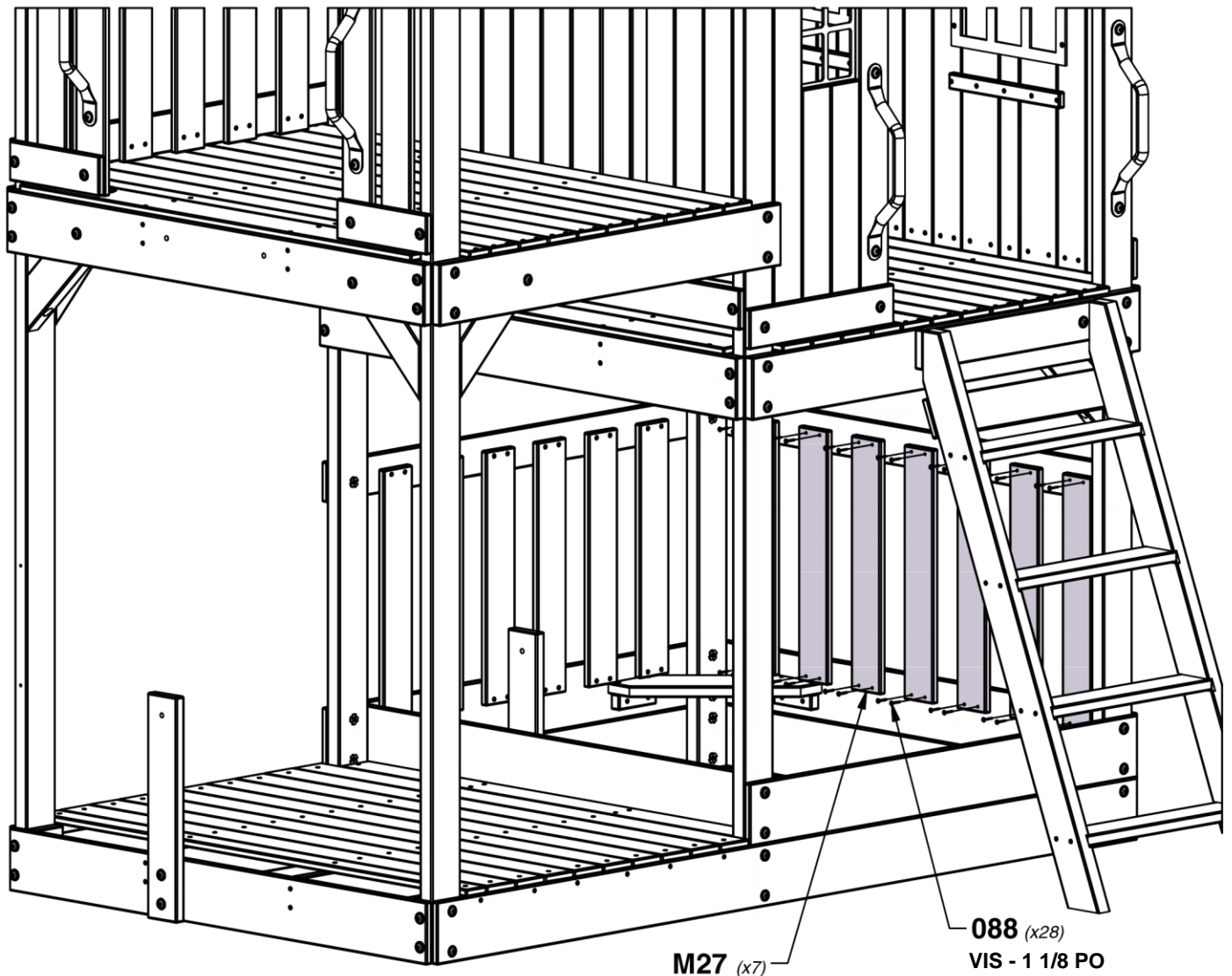
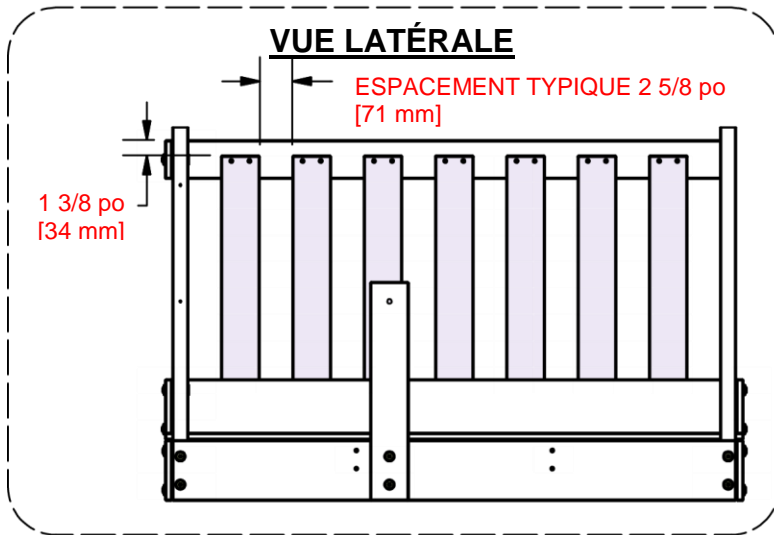

# ÉTAPE 40 - ASSEMBLAGE DU FORT



**M14** SUPPORT DE SIÈGE DE TABLE DE PIQUE-NIQUE - W4L16050  
(x2) 5/8 po x 3 3/8 po x 22 po (16 x 86 x 558)

QTÉ	NUMÉRO D'ARTICLE	DESCRIPTION
2	H100010	BOULON WH 5/16 x1 1/2
2	H100028	VIS TIREFOND WH 5/16 x 2 1/2
4	H100030	RONDELLE DE VERROUILLAGE EXT 8 x 19
2	H100074	ÉCROU À ENFONCER 5/16

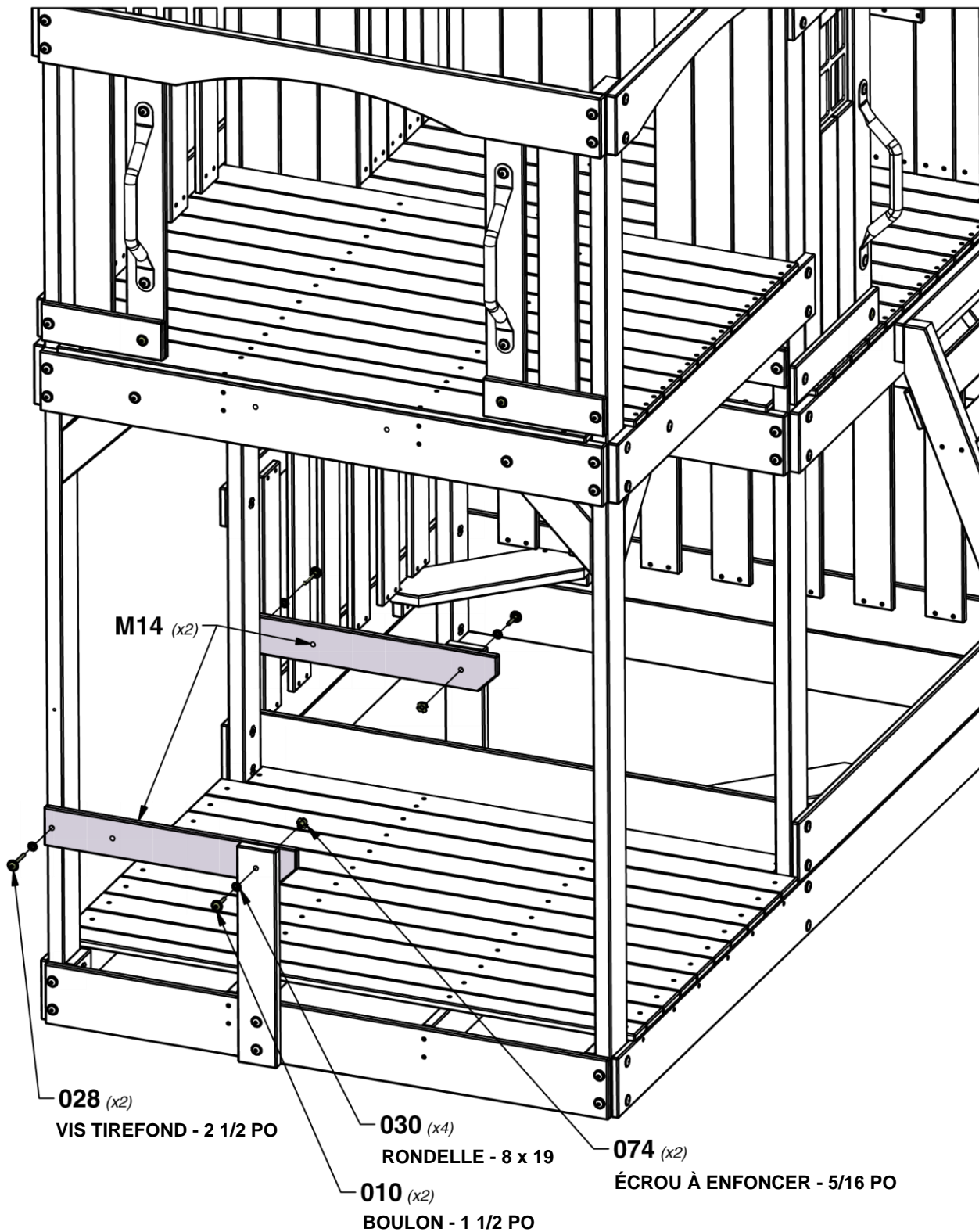

# ÉTAPE 41 - ASSEMBLAGE DU FORT



**M25** SUPPORT DE TABLE - W4L16037  
(x2) 5/8 po x 3 3/8 po x 13 1/2 po (16 x 86 x 342)

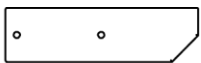

**H08** SUPPORT DE TABLE - W4L16031  
(x2) 1 po x 3 3/8 po x 12 po (24 x 86 x 306)

QTÉ	NUMÉRO D'ARTICLE	DESCRIPTION
2	H100013	BOULON WH 5/16 x 1 1/4
2	H100030	BOULON WH 5/16 x 1 1/2
2	H100074	VIS TIREFOND WH 5/16 x 2 1/2
6	H100013	RONDELLE DE VERROUILLAGE EXT 8 x 19
4	H100013	ÉCROU À ENFONCER 5/16

**CONSEIL :**  
INSTALLER D'ABORD DES ÉCROUS A ENFONCER DANS LE BOIS

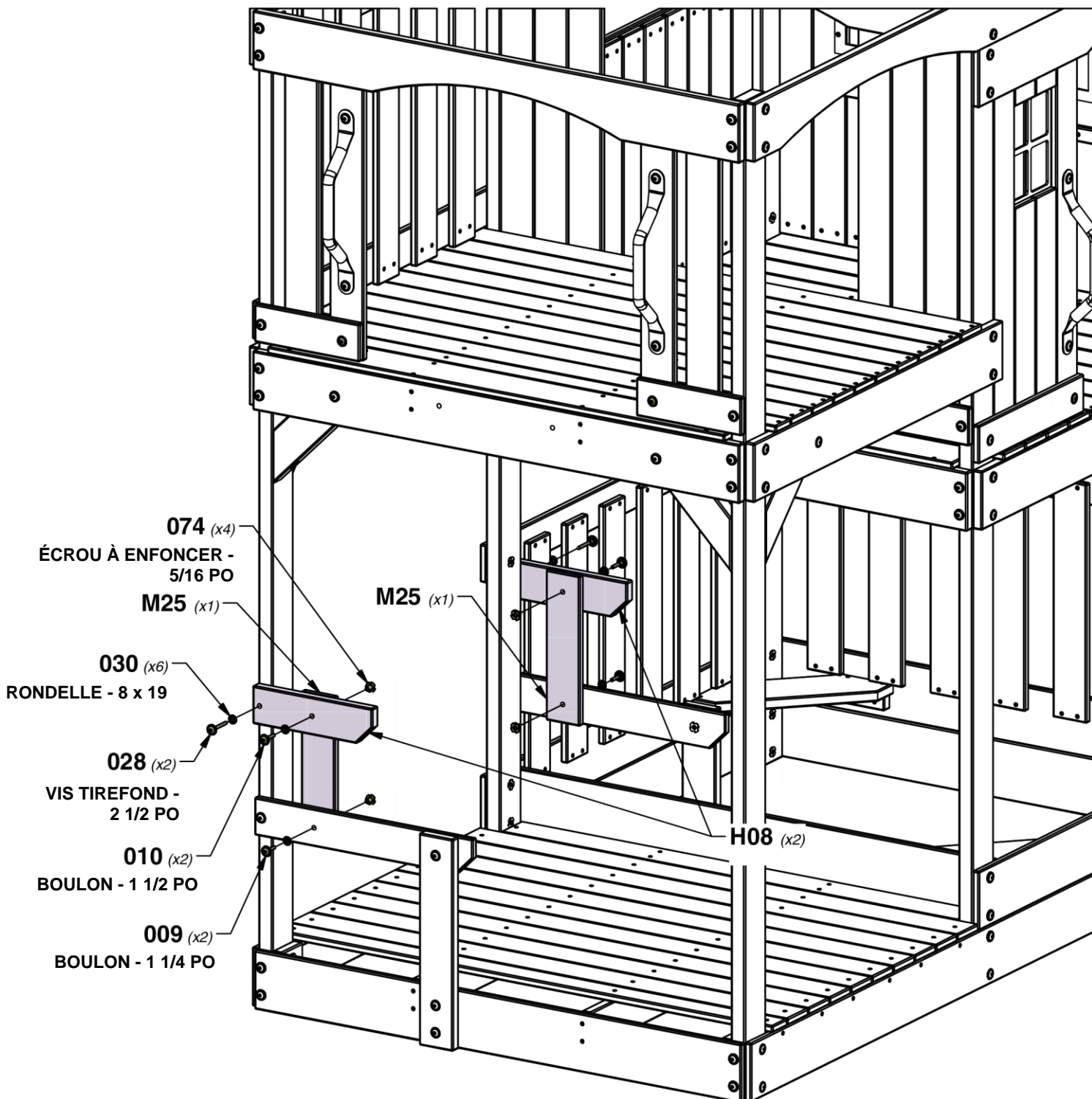

# ÉTAPE 42 - ASSEMBLAGE DU FORT

QTÉ	NUMÉRO D'ARTICLE	DESCRIPTION
1	H100088	VIS TÊTE PLATE PFH 8 x 1-1/8 PO
1	H100089	VIS TÊTE PLATE PFH 8 x 1-3/4 PO

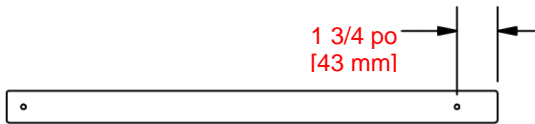

**O03** LISSE DE SÉCURITÉ - W4L16083  
(x1) 5/8 po x 1 3/8 po x 20 1/2 po (16 x 34 x 520)

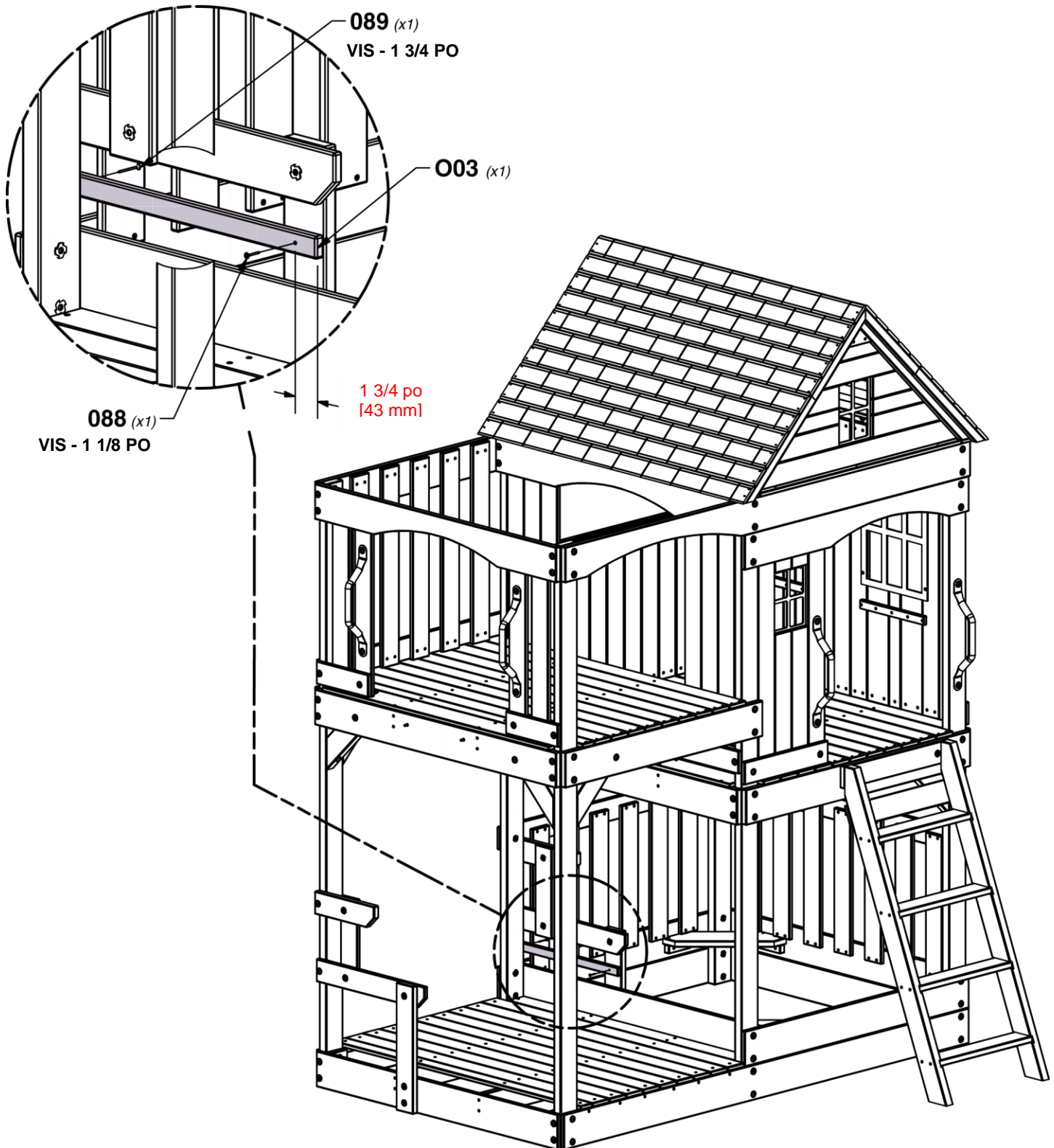

# ÉTAPE 43 - ASSEMBLAGE DU FORT

QTÉ	NUMÉRO D'ARTICLE	DESCRIPTION
16	H100089	VIS TÊTE PLATE PFH 8 x 1-3/4 PO

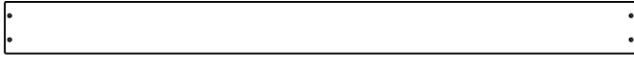

**H02** | SIÈGE DE TABLE DE PIQUE-NIQUE - W4L16025  
(x2) | 1 po x 3 3/8 po x 41 3/8 po (24 x 86 x 1050)



**G11** | PLATEAU DE LA TABLE DE PIQUE-NIQUE - W4L16011  
(x2) | 5/8 po x 5 1/4 po x 42 po (16 x 134 x 1066)

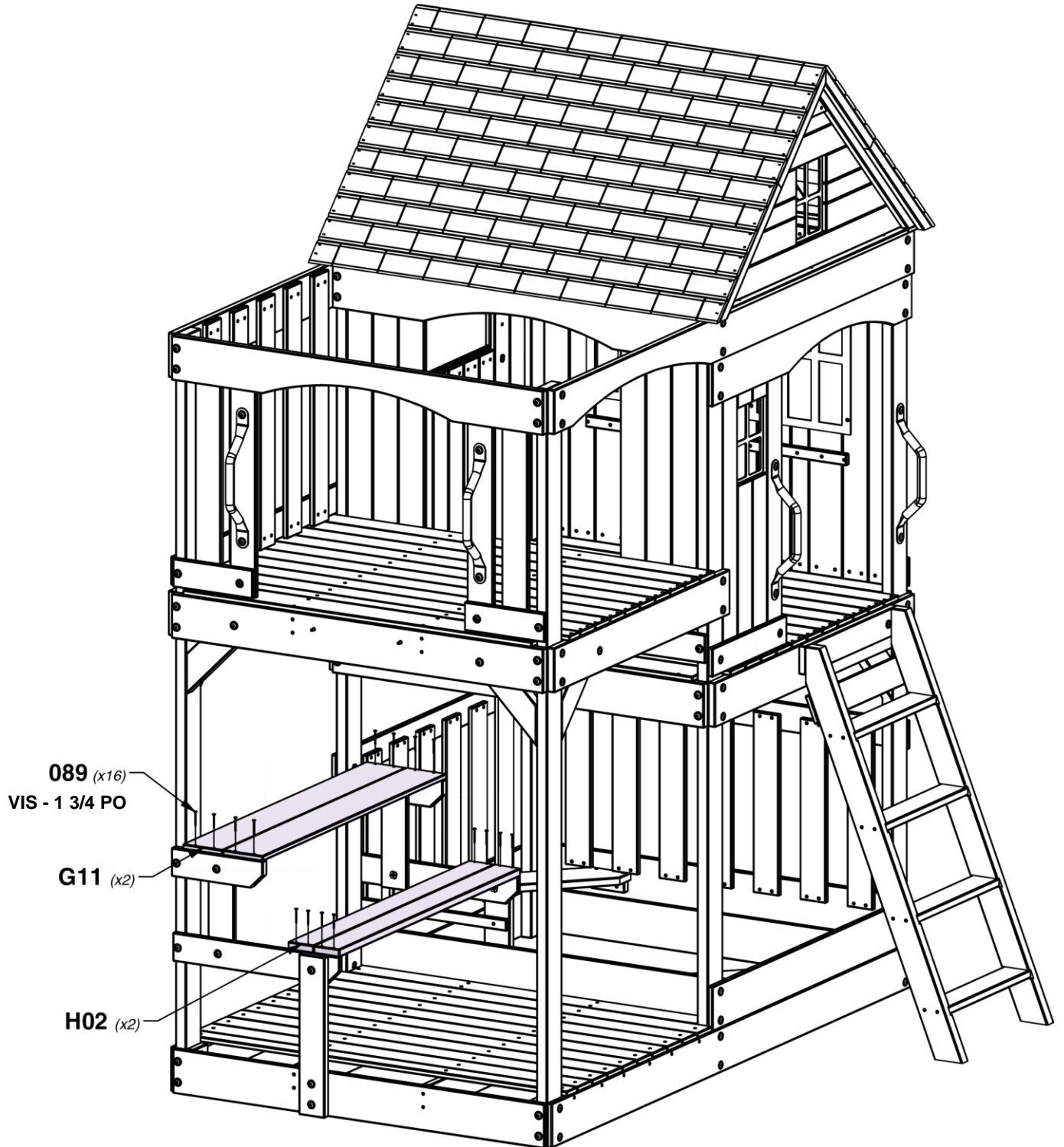

# ÉTAPE 44 - ASSEMBLAGE DU FORT

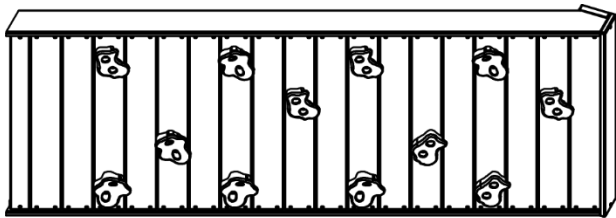

ASSEMBLAGE DU MUR D'ESCALADE

QTÉ	NUMÉRO D'ARTICLE	DESCRIPTION
2	H100011	BOULON WH 5/16 x 1 3/4
2	H100030	RONDELLE DE VERROUILLAGE EXT 8 x 19

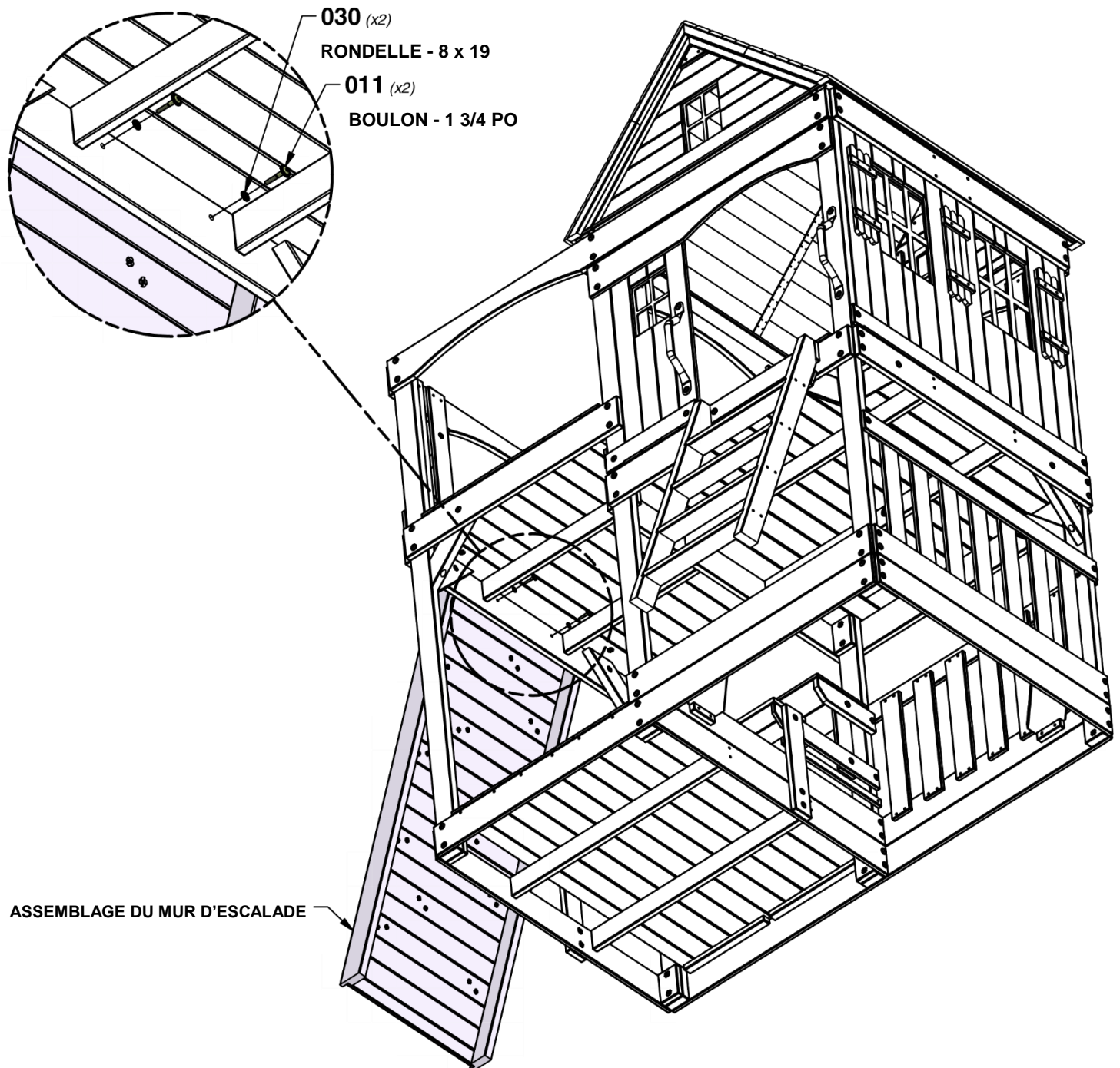

# ÉTAPE 45 - ASSEMBLAGE DU FORT

QTÉ	NUMÉRO D'ARTICLE	DESCRIPTION
4	H100086	BOULON HEX 5/16 x 1-1/4
4	H100086	RONDELLE FENDUE 5/16
4	H100086	RONDELLE PLATE 8 x 27

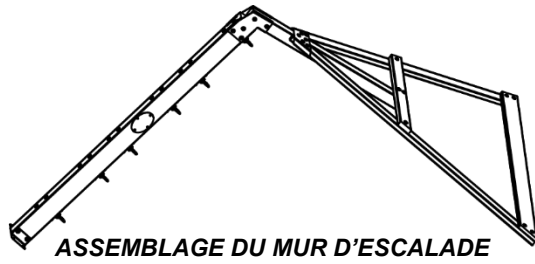

042 (x4)  
BOULON HEXAGONAL - 1 1/4 PO

095 (x4)

RONDELLE - 5/16 PO

105 (x4)

RONDELLE - 8 x 27

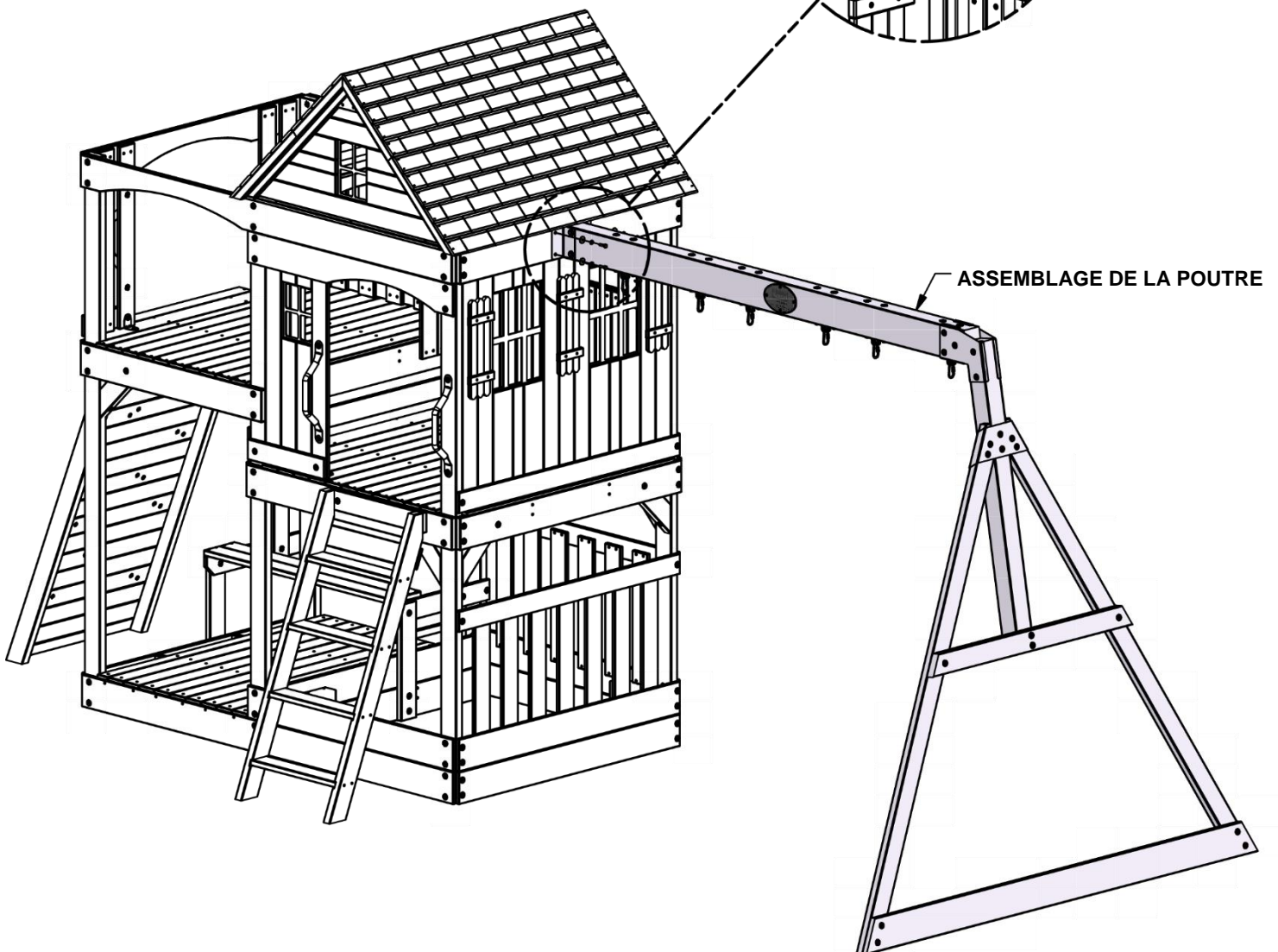
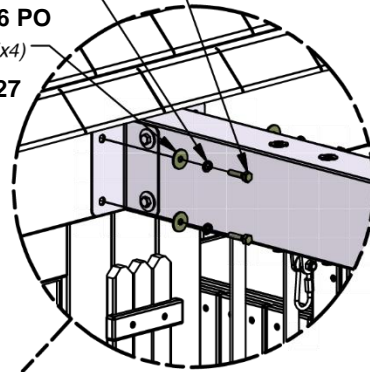

# ÉTAPE 46 - ASSEMBLAGE DU FORT



**A100027** | SIÈGE DE BALANÇOIRE VERT  
(x2) | 26 PO [660,4 MM]



**A6P00034** | TRAPÈZE JAUNE  
(x1)

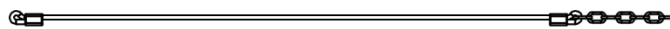

**A100183** | CORDE - CHAÎNE VERTE 57 PO (144,78 CM)  
(x4)



**A100083** | CORDE - CHAÎNE VERTE 33 PO (83,82 CM)  
(x2)

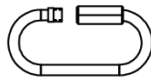

**A100069** | MAILLON RAPIDE  
(x6)

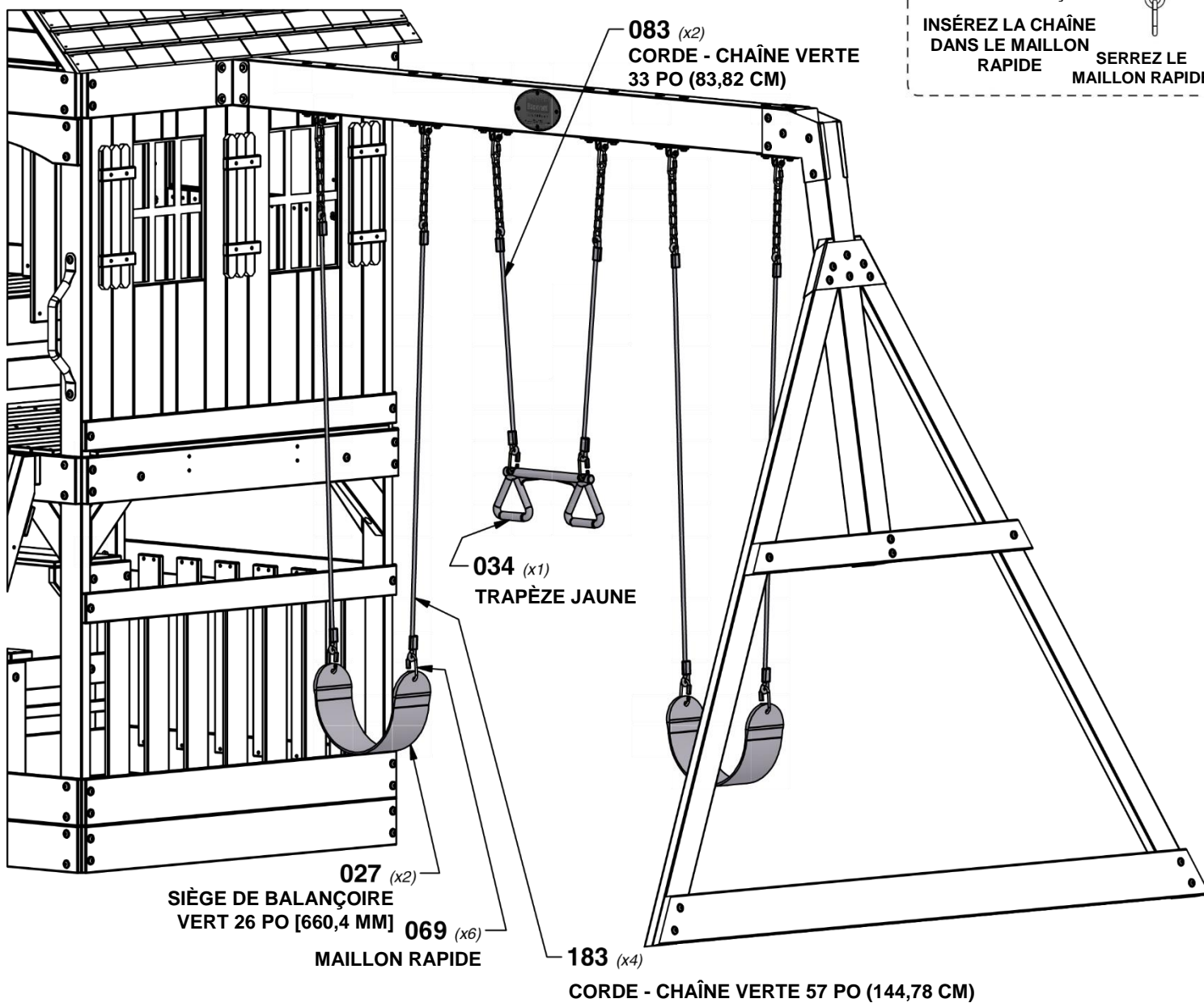
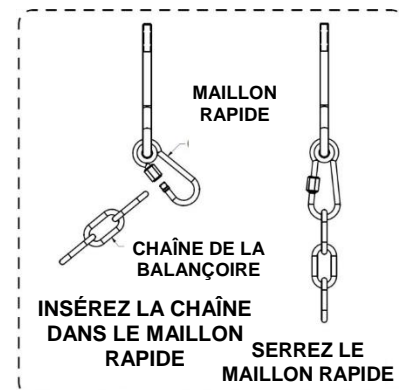

# ÉTAPE 1 - TOBOGGAN

QTÉ	NUMÉRO D'ARTICLE	DESCRIPTION
3	H100074	ÉCROU À ENFONCER 5/16
3	H100074	BOULON WH 5/16 x 1/2



**A100035** (x1) | LIT DE TOBOGGAN DE 2,4 M (10 PI) VERT CLAIR

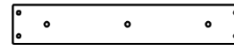

**M70** (x1) | PLANCHE DE SUPPORT DU TOBOGGAN - W100935  
5/8 po x 3 3/8 po x 19 7/8 po (16 x 86 x 505)

**REMARQUE :**  
PRENEZ NOTE DE LA FINITION DE LA SURFACE DU LIT DU TOBOGGAN, LE CÔTÉ MAT DOIT ÊTRE ORIENTÉ VERS LE SOL. PLACEZ LE SUPPORT DU TOBOGGAN CENTRÉ SUR LE BAS (CÔTÉ MAT) ET À 1/2 PO DU BORD. UTILISEZ LA PLANCHE **M70** COMME GABARIT POUR PERCER LES TROUS INFÉRIEURS DANS LE LIT DU TOBOGGAN. UTILISEZ UNE MÈCHE DE 5/16 PO.

HAUT

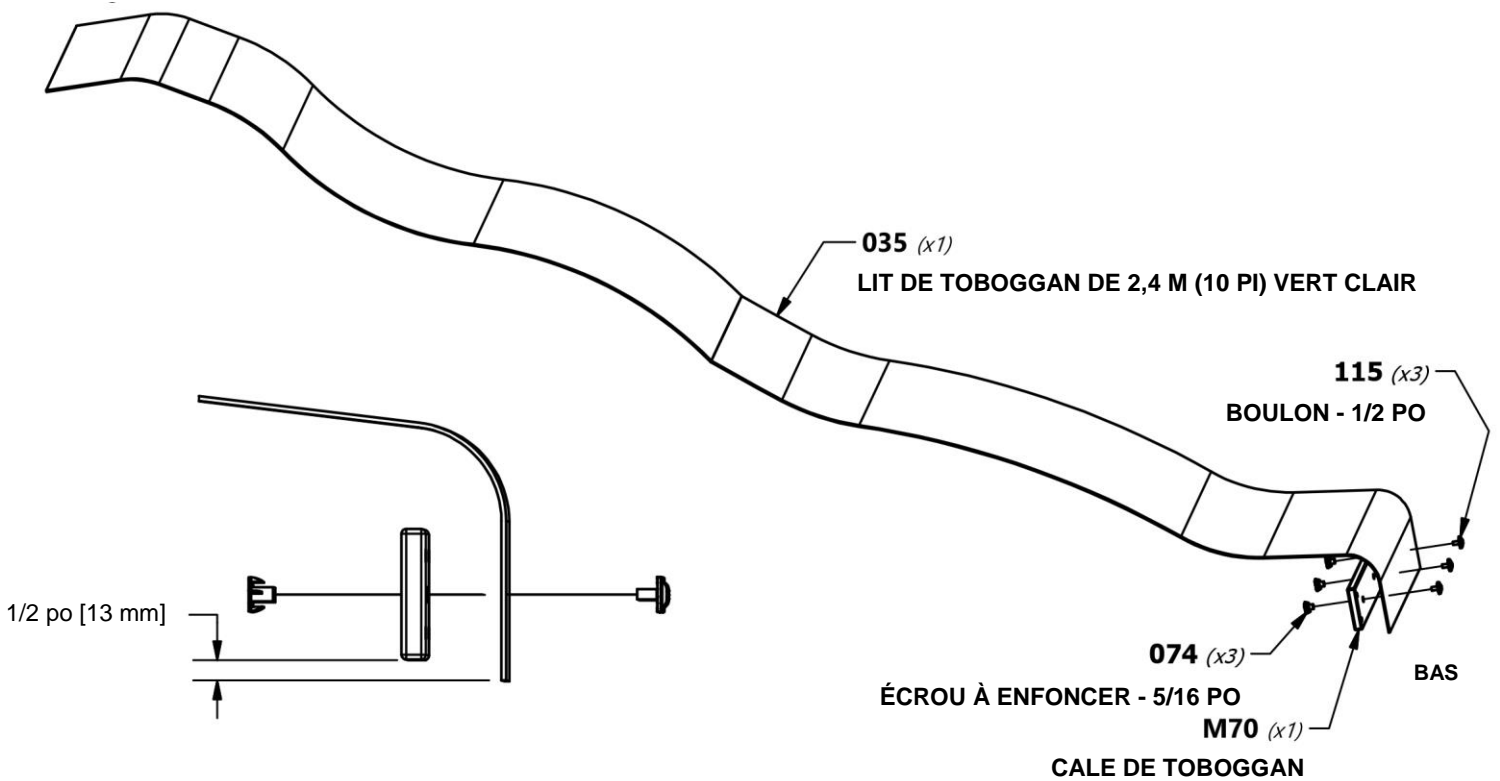

**CONSEIL :**  
PRÉREPLIER LES EXTRÉMITÉS FACILITERA LE MONTAGE.  
PLACER LE LIT DU TOBOGGAN AU SOLEIL FACILITE LE PLIAGE.



# ÉTAPE 2 - TOBOGGAN

QTÉ	NUMÉRO D'ARTICLE	DESCRIPTION
8	H100006	ÉCROU À PORTÉE CYLINDRIQUE WH 5/16 x1 1/2
8	H100115	BOULON WH 5/16 x 1/2

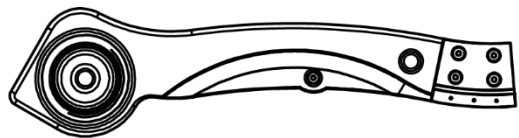

**A6P00484** | GLISSIÈRE DE TOBOGGAN DE 3,05 M (10 PI)  
(x1) VERTE INFÉRIEURE DROITE

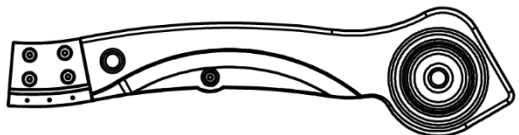

**A6P00483** | GLISSIÈRE DE TOBOGGAN DE 3,05 M (10 PI)  
(x1) VERTE INFÉRIEURE GAUCHE

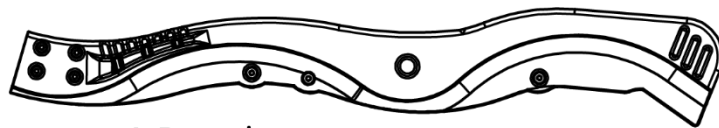

**A6P00486** | GLISSIÈRE DE TOBOGGAN DE 3,05 M (10 PI)  
(x1) VERTE SUPÉRIEURE DROITE

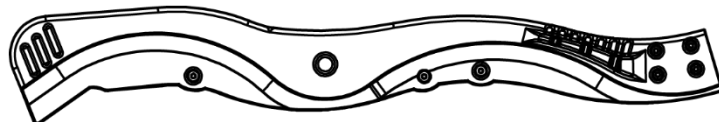

**A6P00485** | GLISSIÈRE DE TOBOGGAN DE 3,05 M (10 PI)  
(x1) VERTE SUPÉRIEURE GAUCHE

**REMARQUE :**  
RÉPÉTEZ DE L'AUTRE CÔTÉ, EN FAISANT  
UN ASSEMBLAGE GAUCHE ET DROIT.

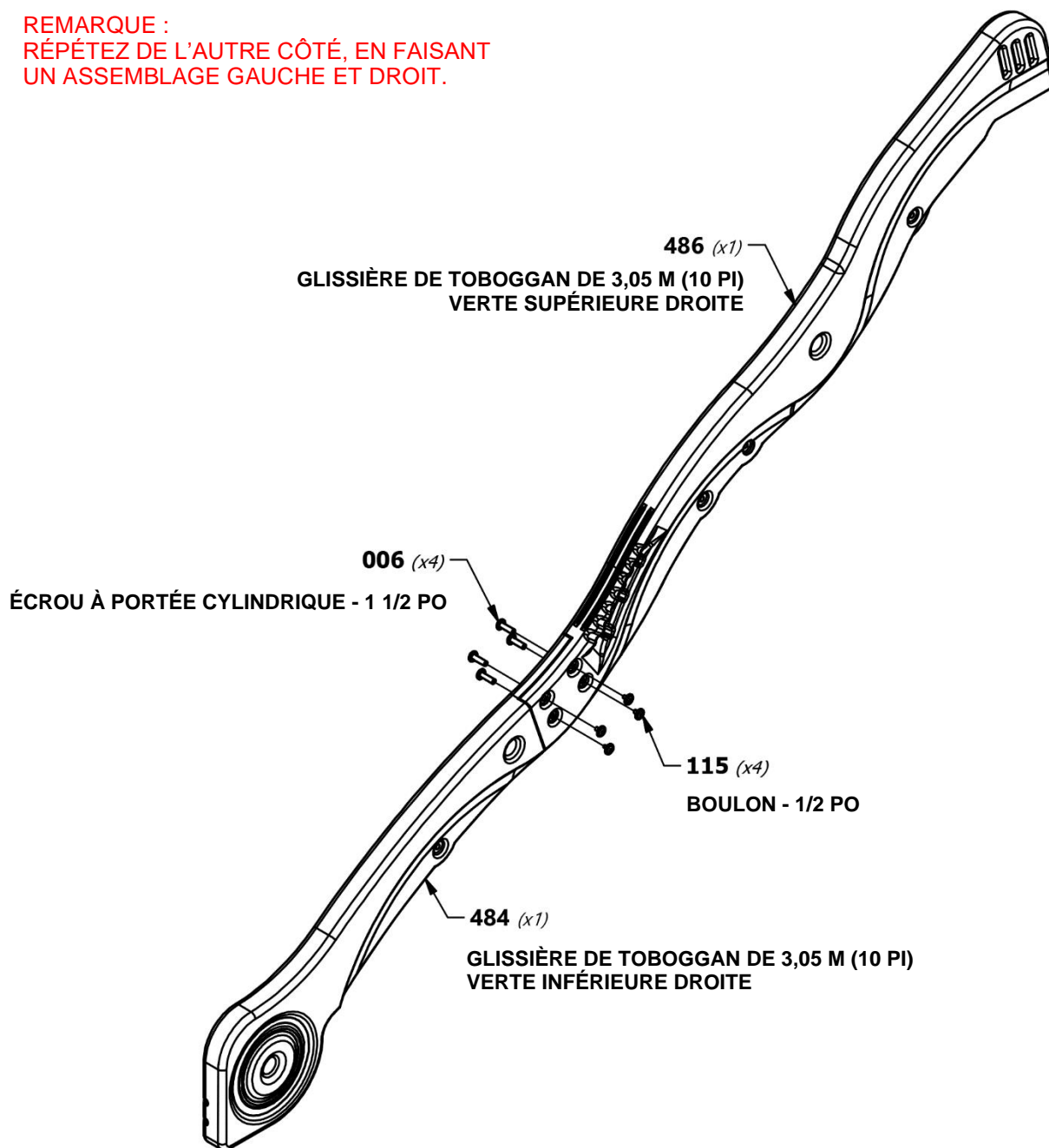

# ÉTAPE 3 - TOBOGGAN

QTÉ	NUMÉRO D'ARTICLE	DESCRIPTION
4	H100009	BOULON WH 5/16 x 1 1/4



A6P00487 (x4) | SUPPORT DES TUBES DU TOBOGGAN

**REMARQUE :**  
INSÉREZ LES (4) TUBES DE SUPPORT DU TOBOGGAN DANS LEURS EMPLACEMENTS DE RÉFÉRENCE RESPECTIFS (FIGURE 1).

PLACEZ (1) ASSEMBLAGE DE GLISSIÈRE DE TOBOGGAN SUR UNE SURFACE PLANE ET COMMENCEZ À INSÉRER LE LIT DU TOBOGGAN AU BAS DE LA GLISSIÈRE DU TOBOGGAN (FIGURE 2). DEMANDEZ À UN ASSISTANT DE PLIER LE LIT DU TOBOGGAN VERS LE HAUT DU TOBOGGAN ET INSÉREZ LE LIT DANS LA CAVITÉ DU TOBOGGAN. ASSUREZ-VOUS QUE LE LIT DU TOBOGGAN EST INSÉRÉ À MOINS DE 1/8 po (3 mm) DU FOND DE LA RAINURE.

**CONSEIL :**  
IL EST RECOMMANDÉ DE VOUS FAIRE ASSISTER PAR UNE AUTRE PERSONNE POUR LES ÉTAPES SUIVANTES.

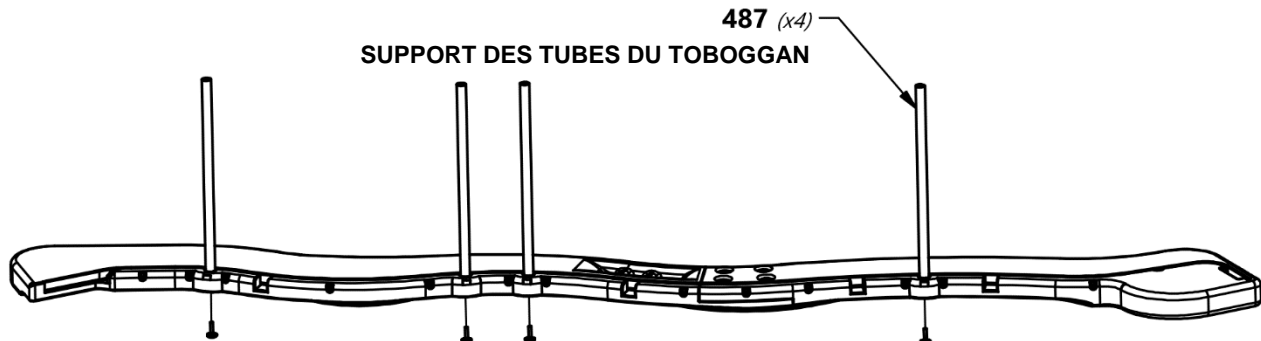

FIGURE 1

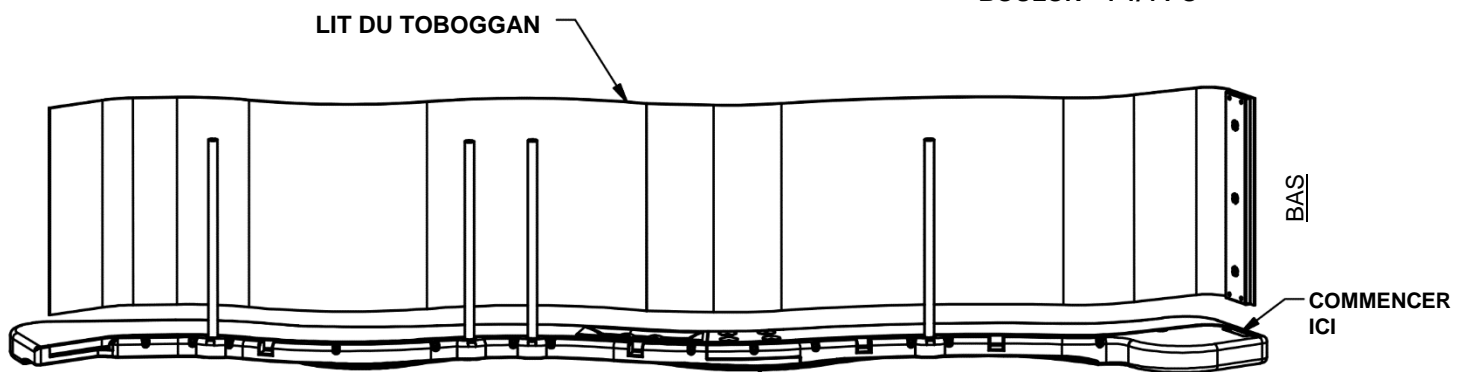
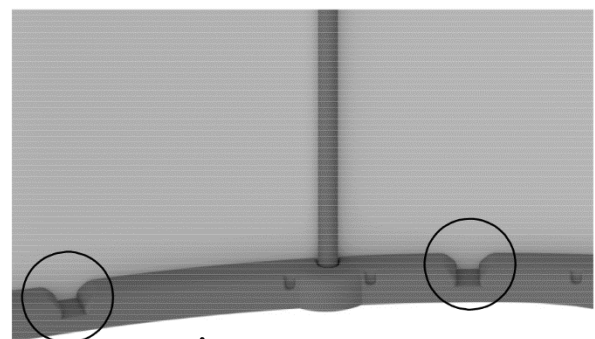
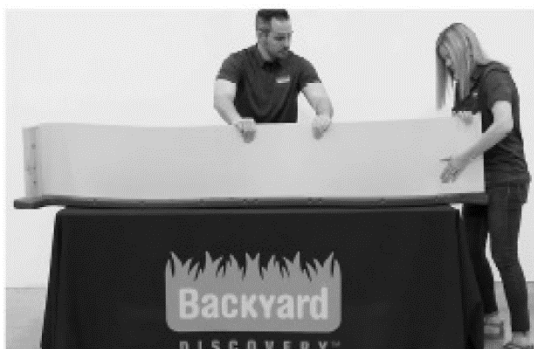

FIGURE 2



FENÊTRES D'OBSERVATION

## ÉTAPE 4 - TOBOGGAN

### REMARQUE :

PLACEZ LE DEUXIÈME ASSEMBLAGE DE GLISSIÈRE DE TOBOGGAN SUR LE DESSUS DU LIT DU TOBOGGAN ET DES TUBES DE SUPPORT DU TOBOGGAN. INSÉREZ LE LIT DU TOBOGGAN ET LES TUBES DE SUPPORT DE TOBOGGAN DANS LA CAVITÉ DU TOBOGGAN. ASSUREZ-VOUS QUE LE LIT DU TOBOGGAN EST INSÉRÉ À MOINS DE 1/8 po (3 mm) DU FOND DE LA RAINURE.



**NE PAS INSÉRER CORRECTEMENT LE LIT DU TOBOGGAN PEUT ENTRAÎNER UNE BLESSURE OU UNE AMPUTATION. LES BORDS EXPOSÉS DU TOBOGGAN PEUVENT ÊTRE COUPANTS ET CONSTITUER UN RISQUE DE LACÉRATION SI LE TOBOGGAN N'EST PAS ASSEMBLÉ CORRECTEMENT.**

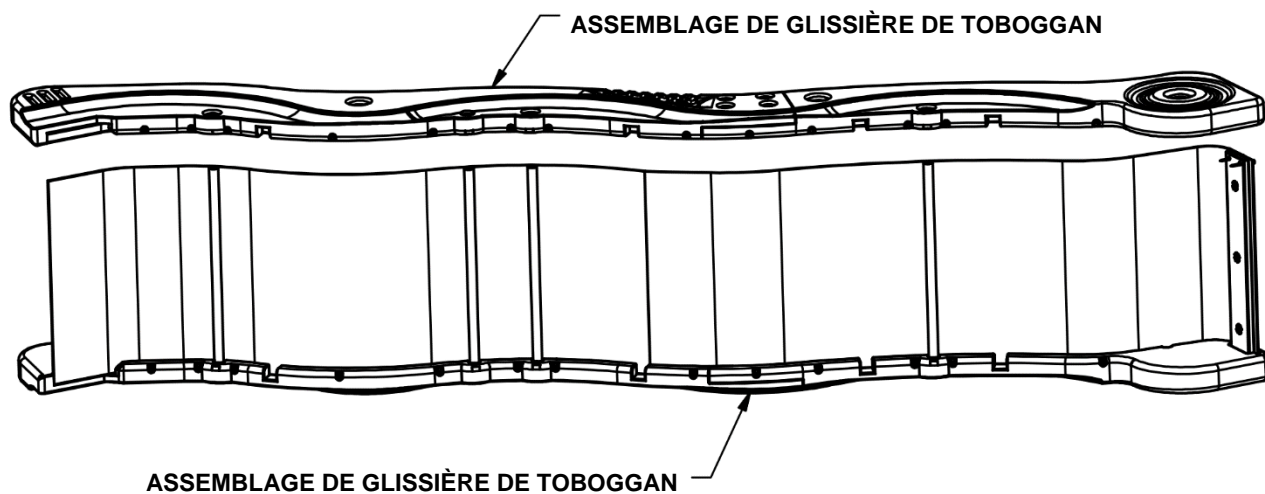

**CONSEIL :**  
UTILISEZ UN MAILLET EN CAOUTCHOUC POUR PLACER COMPLÈTEMENT LE LIT DU TOBOGGAN DANS LA CAVITÉ DU TOBOGGAN.

## ÉTAPE 5 - TOBOGGAN

QTÉ	NUMÉRO D'ARTICLE	DESCRIPTION
4	H100009	BOULON WH 5/16 x 1 1/4

REMARQUE :  
UTILISEZ DES BOULONS DE 1 1/4 po POUR  
FIXER CHAQUE CÔTÉ DES TUBES DE  
SUPPORT DU TOBOGGAN.

CONSEIL :  
DEMANDER L'AIDE D'UNE AUTRE  
PERSONNE POUR TENIR L'ASSEMBLAGE  
DU TOBOGGAN PENDANT QUE VOUS LE  
FIXEZ FACILITERA L'ASSEMBLAGE.

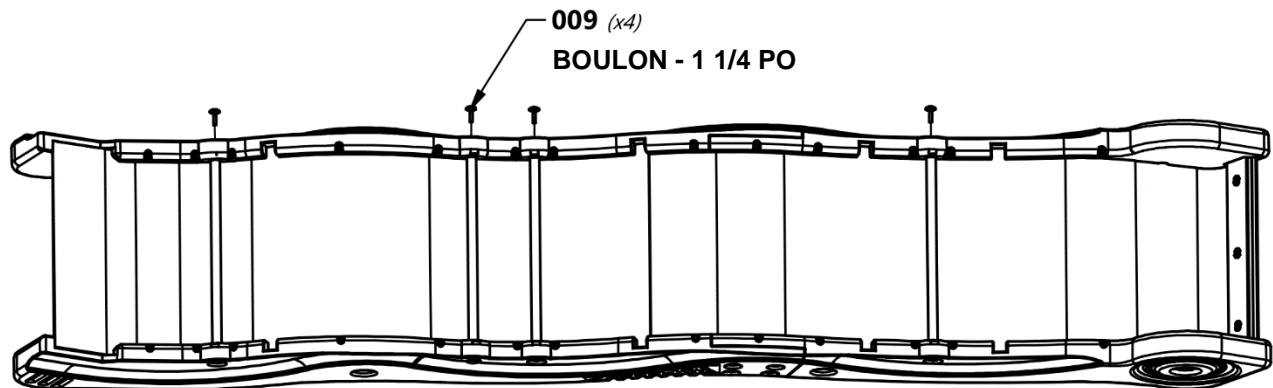

## ÉTAPE 6 - TOBOGGAN

QTÉ	NUMÉRO D'ARTICLE	DESCRIPTION
30	H100090	VIS TÊTE PLATE PFH 8 x 2 1/2

REMARQUE :  
À L'AIDE D'UN FORET DE 1/8 PO, PERCEZ DES AVANT-TROUS DANS CHAQUE ENCOCHE LE LONG DE CHAQUE LISSE LATÉRALE. IL DEVRAIT Y AVOIR 15 ENCOCHES SUR CHAQUE GLISSIÈRE. ASSUREZ-VOUS DE PERCER À TRAVERS LA GLISSIÈRE DU TOBOGGAN ET À TRAVERS LE LIT DU TOBOGGAN. PUIS FIXEZ AVEC LES PIÈCES DE QUINCAILLERIE FOURNIES.

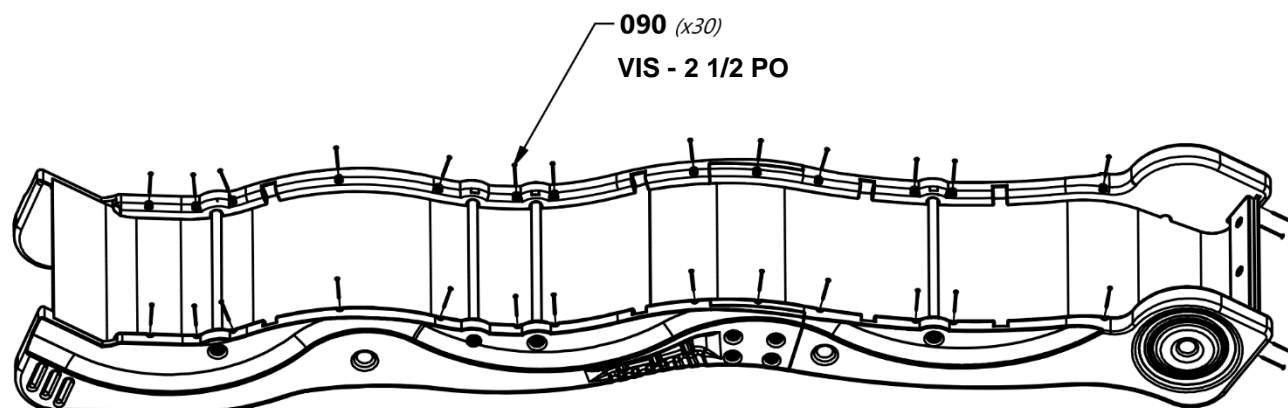

# ÉTAPE 47 - ASSEMBLAGE DU FORT

QTÉ	NUMÉRO D'ARTICLE	DESCRIPTION
3	H100074	ÉCROU À ENFONCER 5/16
3	H100115	BOULON WH 5/16 x 1/2

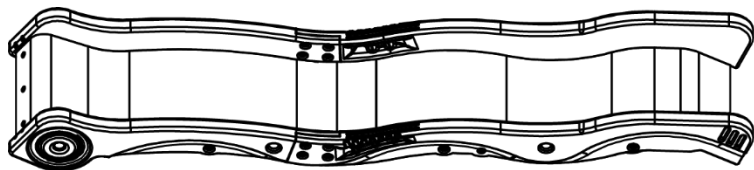

ASSEMBLAGE DU TOBOGGAN

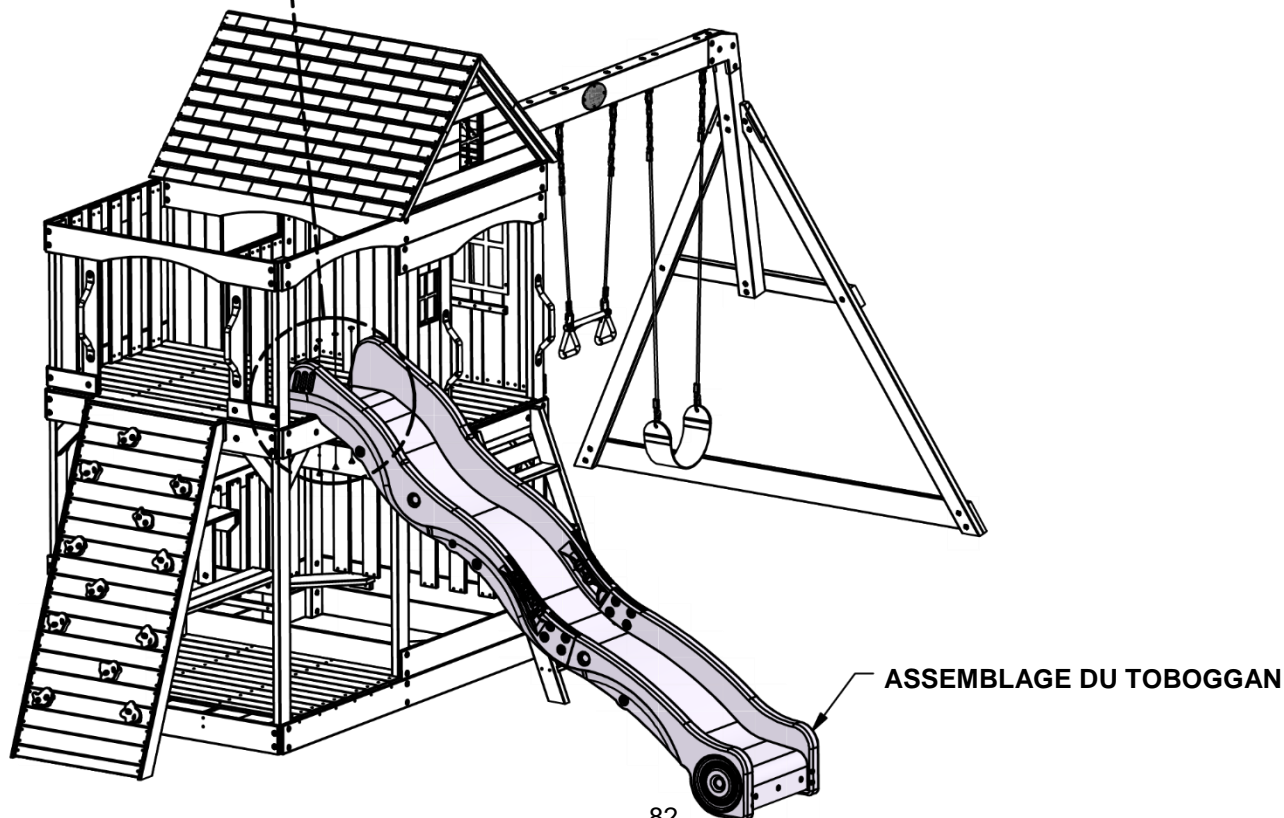
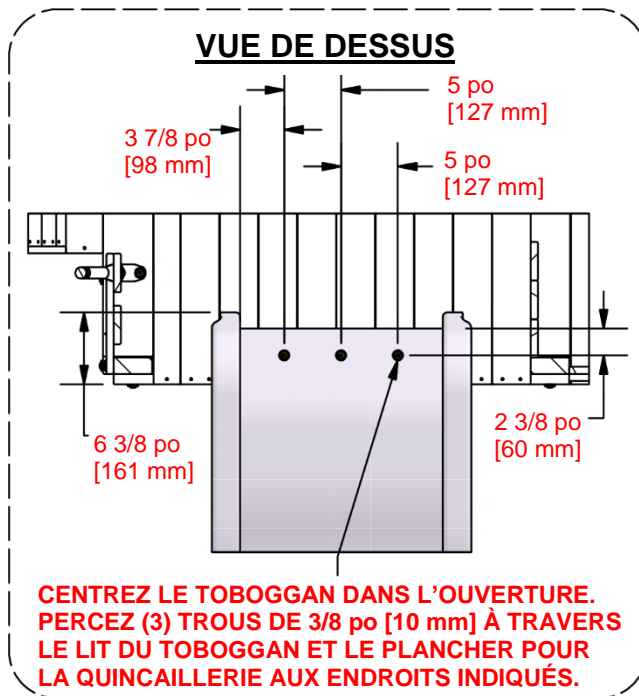
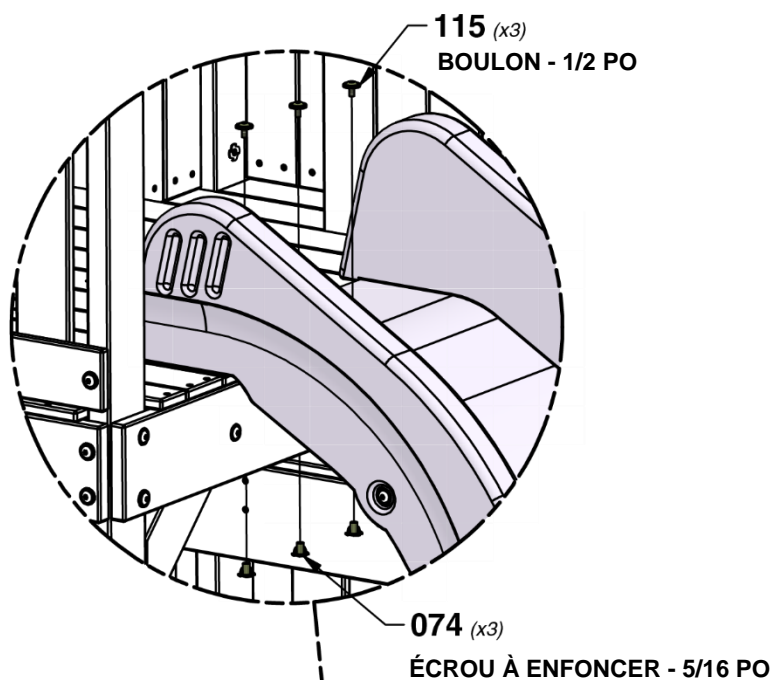

# ÉTAPE 48 - ASSEMBLAGE DU FORT

QTÉ	NUMÉRO D'ARTICLE	DESCRIPTION
8	H100004	ÉCROU À PORTÉE CYLINDRIQUE WH 5/16 x 5/8
8	H100031	RONDELLE DE VERROUILLAGE EXT 12 x 19
2	H100008	BOULON WH 5/16 x 1
2	H100009	BOULON WH 5/16 x 1 1/4
4	H100222	BOULON WH 5/16 x 3/4



DÉTAIL « A » DÉTAIL « A »



ENFONCEZ UNE TARIÈRE (178) DANS LE SOL AUX EMPLACEMENTS INDICUÉS. EN UTILISANT LA TARIÈRE COMME GUIDE, PERCEZ UN TROU DE 7/16 PO [10 mm] POUR LA QUINCAILLERIE.

DÉTAIL « B » DÉTAIL « B » DÉTAIL (C)

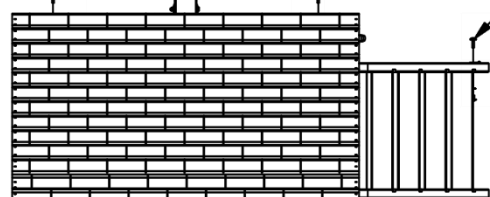

DÉTAIL « B » DÉTAIL « B »

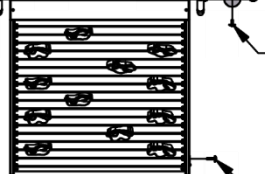

DÉTAIL (C)

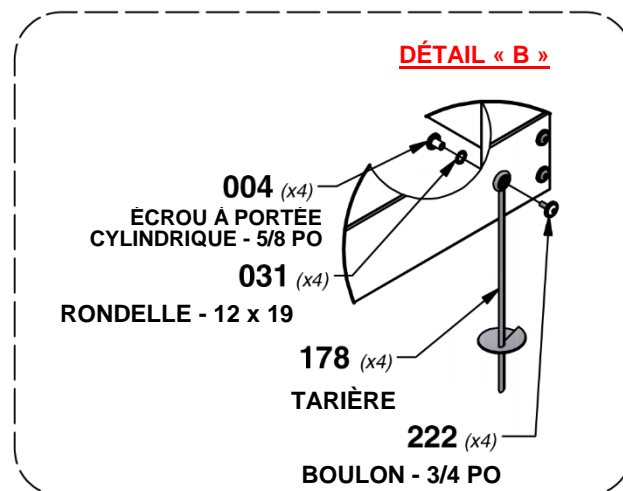
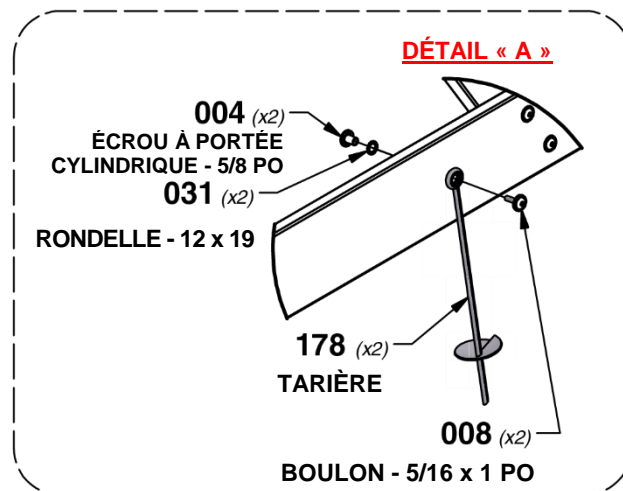

ENFONCEZ UNE TARIÈRE (527) DANS LE SOL AUX EMPLACEMENTS INDICUÉS. EN UTILISANT LA TARIÈRE COMME GUIDE, PERCEZ UN TROU DE 7/16 PO [10 mm] POUR LA QUINCAILLERIE.

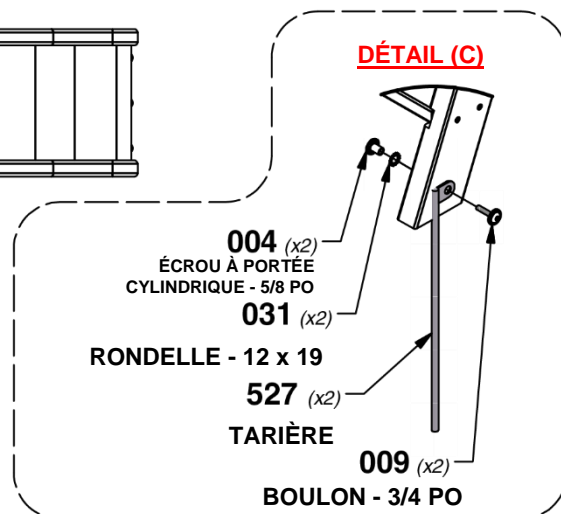

# ÉTAPE 49 - ASSEMBLAGE DU FORT



**Y01** | **PLANCHE DE PLANCHER DE REMPLISSAGE EXTÉRIURE - W4L16087**  
(x1) 5/8 po x 4 po x 46 po (16 x 102 x 1168)

QTÉ	NUMÉRO D'ARTICLE	DESCRIPTION
6	H100086	VIS TÊTE PLATE PFH 8 x 1-1/2 PO

