

evenflo®

LiteMax™ 35 / SafeMax™

Rear-facing Child Restraint System

Owner's Manual Keep for future use.



Para instrucciones en Español,
llamar al: 1-800-233-5921

⚠️ WARNING:

To reduce the risk of serious injury or death, read this owner's manual prior to installing and using this child restraint.

More children are killed every year as passengers in car crashes than by any other type of injury.

To reduce the risk of **SERIOUS INJURY** or **DEATH**, read this owner's manual and your vehicle owner's manual before installing and using this child restraint.

Using a child restraint makes a big difference. By properly using this child restraint and following these instructions (and the instructions that accompany your vehicle), you will greatly reduce the risk of serious injury or death to your child from a crash.

Do not be misled by the commonly used term "safety seat"; no restraint system can prevent all injuries in all crashes. Many properly restrained adults and children are injured in motor vehicle crashes, including relatively minor crashes.

A properly used child restraint is the best way to minimize injuries to your child and to increase the chances for your child's survival in most crashes.

U.S. Regulatory Notice

This child restraint meets all the requirements of Federal Motor Vehicle Safety Standard 213.

For Canadian Models

CANADIAN REGULATORY NOTICE (MODEL NUMBERS ENDING IN "C")

This child restraint meets all the applicable requirements of Canadian Motor Vehicle Safety Standard 213 and 213.1.

Symbol Legend



Airbag Symbol – Alerts you to important information about airbag safety.



LATCH Symbol – Alerts you to important information about LATCH safety.



Aircraft Symbol – Alerts you to important information about aircraft safety.

Table of Contents (TOC)

Child Requirements	6
Premature Infant Use	8
Warnings	10
LATCH Warnings.....	22
Safe Practices	28
For Recall Information for U.S. Customers.....	29
Public Notice for Canadian Customers.....	30
Motor Vehicle/Aircraft Usage	31
Base Features	32
Child Seat Features	34
Using the Handle.....	36
Proper Installation WITH the Convenience Base ...	39
Installation Checklist	40
Installing the Convenience Base with the Lower Anchor Connector Assembly	42
Installing the Convenience Base with the Vehicle Seat Belt	53
Placing the Carrier in the Base	61
Releasing the Carrier from the Base	64

Proper Installation WITHOUT the Convenience Base.....	65
Installation Checklist	66
Installing the Carrier WITHOUT the Convenience Base.....	68
Securing the Child in the Carrier	74
Removing the Child from the Carrier	78
Changing the Harness Position	79
Changing the Crotch Strap Position.....	83
Changing the Waist Strap Position	87
Removing the Lower Anchor Connector Assembly	94
Using as an Infant Carrier.....	98
Securing Your Child Restraint in Aircraft.....	100
Installing Carrier WITHOUT Convenience Base in Aircraft	101
Installing the Canopy.....	106
Installing the Accessories.....	107
Removing the Seat Pad.....	110
Replacement Parts	114
Care and Cleaning.....	116
Proper Disposal of this Child Restraint.....	117
Limited Warranty	118
Storing Your Instructions.....	120

CHILD REQUIREMENTS

Warning: Failure to follow these Child Requirements could result in serious injury or death.

This child restraint is designed for use by children in **rear-facing** orientation only. To use this child restraint properly, children **MUST** meet the size and age requirements below. In addition, Evenflo recommends consulting with your child's physician before allowing your child to transition from a **rear-facing** to **forward-facing** child restraint.

The American Academy of Pediatrics (AAP) recommends keeping children **rear-facing** until 2 years old or until they reach the maximum height or weight for their child restraint in **rear-facing** orientation. Additionally, some states' laws require children to be **rear-facing** until age 2.

Accordingly, you will see this guidance reflected in the Child Requirements. Please review any applicable local, state or provincial laws related to child passenger safety before installing and using this child restraint.

Rear-facing Use

- 1.8 to 15.8 kg (4 to 35 lbs)
- 43 to 81 cm (17 to 32 in.) and top of child's head is at least 25 mm (1 in.) below the top of the child restraint seat back.

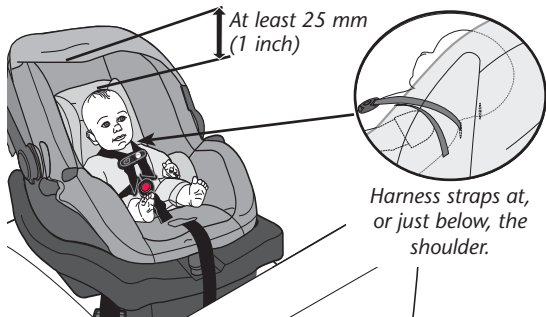

IMPORTANT: Once your child **exceeds** any of the size requirements above, they **MUST** discontinue use of this child restraint.

PREMATURE INFANT USE

Before using this child restraint for preterm or low birth weight infants, ensure the Child Requirements are met and follow the guidelines in this section.

According to the U.S. National Highway Traffic Safety Administration, a properly installed child restraint reduces the risk of death by over 70% for infants involved in crashes. Federal Motor Vehicle Safety Standard (FMVSS) 213 establishes design and dynamic performance requirements for child restraint systems. However, the standard has no minimum weight limit and does not address the special medical needs of preterm or low birth weight infants. To ensure that preterm and low birth weight infants are transported safely, the guidelines published by the American Academy of Pediatrics (AAP) in Pediatrics 2009;123:1424–1429 must be followed.

All children should ride rear-facing in the vehicle as long as possible. Preterm and low birth weight infants are at additional risk of breathing difficulties and heart problems when placed in a child restraint. Evenflo requires that the evaluation recommended by the AAP be conducted for all infants born earlier than 37 weeks and all newborn infants

who weigh less than 5 lb at birth before their first car trip to check for breathing difficulties or heart rate problems when traveling in a rear-facing child restraint.

The AAP recommends that appropriate hospital staff observe your infant in the child restraint for a period of 90 to 120 minutes or the duration of travel, whichever is longer. This period of observation must be performed with the infant properly positioned as described in these instructions and with the child restraint placed at an angle that is approved for use in the vehicle. The hospital staff will check for any breathing difficulties or heart rate problems. Your child's pediatrician will let you know if there are any special considerations for travel. The number of trips and the duration of time the infant is seated in the child restraint should be minimized. A caregiver should ride in the back seat to monitor the infant during travel. You can learn more about the AAP's recommendations for observation of newborns and the guidelines for safe transportation of preterm and low birth weight infants, as well as other resources for parents and medical professionals, at

<https://www.healthychildren.org/english/safety-prevention/on-the-go/Pages/default.aspx>

WARNING! *DEATH or SERIOUS INJURY can occur*

General Warnings

- Child restraints should be used only for travel. Potential adverse health effects from excessive use of infant child restraints have been documented. You should limit the time spent each day in a child restraint as much as possible. You must **NEVER** use your child restraint as a sleeping environment in the home. **NEVER** leave your infant unattended in a child restraint in or out of the vehicle.
- Failure to follow these installation instructions and the instructions and warnings on the product can result in your child striking the vehicle's interior during a sudden stop or crash. Serious injury or death may result. These instructions and the instructions in your vehicle owner's manual must be followed carefully. If there is a conflict between the two, the vehicle owner's manual regarding child restraint installation must be followed.

! WARNING! *DEATH or SERIOUS INJURY can occur*

- This child restraint **MUST ALWAYS** face the **rear of the vehicle**. Serious injury or death can occur if used forward-facing.
- **NEVER** leave child unattended.
- **DO NOT** use child restraint if it is damaged, broken, or missing parts.
- **DO NOT** use this restraint if it has been involved in a crash. It must be replaced.
- **DO NOT** attach additional padding, toys or other devices not made by Evenflo, or described in these instructions, to the child restraint. Items not tested with the child restraint could injure the child.
- Be sure that the handle is firmly locked in *Position 1 (Carry)* before lifting the child restraint (see pages 36-37).
- This child restraint must be securely belted to the vehicle at all times, even when unoccupied. An unsecured child restraint may injure someone if a crash occurs.

! WARNING! *DEATH or SERIOUS INJURY can occur*



DO NOT place rear-facing child seat on front seat with air bag. **DEATH OR SERIOUS INJURY** can occur. The back seat is the safest place for children 12 and under.

! WARNING! *DEATH or SERIOUS INJURY can occur*



Air Bag Warnings

To help prevent serious injury or death:

- **DO NOT** use this restraint in the front seat of a vehicle equipped with an air bag. Interaction between a rear-facing restraint and air bags may cause serious injury or death. If your vehicle has an air bag, refer to the vehicle owner's manual for child restraint installation. If the rear seat of your vehicle is equipped with side air bags, refer to the following information for proper usage.

Vehicles built prior to the 2002 model year:

DO NOT use this restraint in a vehicle seating position equipped with a side air bag unless authorized by the vehicle manufacturer.

Model year 2002 and newer vehicles:

Refer to your vehicle owner's manual before placing this restraint in a seating position equipped with a side air bag.

- **DO NOT** place any objects between the restraint and the side air bag, as an expanding air bag may cause the items to strike your child.

The forward facing back seat is the safest place for children 12 and under.



! WARNING! *DEATH or SERIOUS INJURY can occur*

Location Warnings

To help prevent serious injury or death:

- **ALWAYS** read and follow exactly the instructions that accompany your vehicle and child restraint.
- According to accident statistics, children are safer when properly restrained in a rear seating position than in a front seating position. Generally, the center rear is safest and should be used if available. Children 12 and under should ride in the back seat of the vehicle.
- If you are unable to use the center rear seating position and have to install this child restraint directly behind a front vehicle seat, ensure that there is at least 38 mm (1.5 inches) of space between any part of the child restraint and the vehicle seat that is closest to the child's head. This space may be necessary for the child restraint to properly perform in certain types of crashes.
- **ONLY** use this child restraint on forward-facing vehicle seats. **DO NOT** use on vehicle seats which face the rear or side.



! WARNING! DEATH or SERIOUS INJURY can occur

- **ONLY** use this child restraint on vehicle seats with backs that lock into place.
- Some child restraints do not fit all vehicles or all seating locations. There are thousands of combinations of vehicle makes, models, child restraint configurations, seat belt designs and seat cushion shapes. The easiest way to determine whether your child restraint is suitable for a particular seating position is to check for a tight installation. If the child restraint cannot be properly installed, **DO NOT** use this child restraint. Consult vehicle owner's manual, try a different seating location or call Evenflo at 1-800-233-5921 (U.S), or 1-937-773-3971 (Canada).

VEHICLE TYPES WHICH THE RESTRAINT SYSTEM CAN NOT BE USED:

This child restraint is not to be used in vehicles that do not have vehicle seat belts or UAS lower anchorages.

! WARNING! *DEATH or SERIOUS INJURY can occur*

Vehicle Seat Belt Warnings

To help prevent serious injury or death:

- **ALWAYS** read your vehicle owner's manual to determine what vehicle belts and retractors are used in your vehicle belt. The vehicle belt **MUST** lock and **MUST NOT** loosen after the seat belt is tightened.
 - **DO NOT** use this child restraint if it moves more than 25 mm (1 in.) side to side or front to back at either the rear-facing or forward-facing belt path on the child restraint. Serious injury or death may result from poor installation. If you cannot tightly secure the child restraint, try again or move it to another location.
 - **DO NOT** loosen the vehicle seat belt to provide more leg room as this will prevent the child restraint from protecting your child.
-
- **DO NOT** use this child restraint in a seating position with door-mounted seat belts.

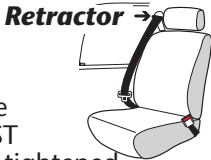

! WARNING! *DEATH or SERIOUS INJURY can occur*

- **DO NOT** use this child restraint in a vehicle with seat belts that automatically move along the vehicle frame when the door is opened.



- **DO NOT** use this child restraint in a vehicle equipped with lap belts that only lock during a sudden stop or crash (emergency locking retractor – ELR). You must use a seating location with a locking seat belt. Check your vehicle owner's manual to see if you have lap belts with ELRs.



- **DO NOT** use on vehicle seats when both portions of the vehicle belts are positioned forward of the seat crease.



! WARNING! *DEATH or SERIOUS INJURY can occur*

Vehicle Seat Belt Warnings (cont.)

To help prevent serious injury or death:

- **DO NOT** use with lap/shoulder belts with two retractors. If the vehicle seat belts are not routed and fastened correctly, the child restraint may not protect the child in a crash.



- **DO NOT** use with inflatable seat belts.
-
- Check your vehicle owner's manual to determine how to lock your seat belt for child restraint installation. The seat belt must be locked to properly secure the child restraint.
 - **DO NOT** allow the vehicle seat belt release button to touch the child restraint. Accidental contact may cause the seat belt to release. If necessary, turn the seat belt release button away from the child restraint or move the child restraint to a different location.
 - Failure to adjust the harness or vehicle seat belts snugly around the child may result in the child striking the vehicle's interior during a sudden stop or crash. Serious injury or death may occur.

! WARNING! *DEATH or SERIOUS INJURY can occur*

- This child restraint must be securely belted to the vehicle, **even when they are unoccupied**, since in a crash an unsecured child restraint system may injure other occupants.
- Fold-down armrests could pose a hazard to a rear-facing child in certain types of collisions. Consult your vehicle owner's manual before installing any rear-facing child restraint in front of a fold-down armrest.
- The headrest on the vehicle seat that the child faces should be placed in the lowest position. The vehicle seat back that the child faces must be fully padded and free of any hard objects.

! WARNING! *DEATH or SERIOUS INJURY can occur*

Vehicle Seat Belt Warnings (cont.)

To help prevent serious injury or death:

If you have any of these types of vehicle belt systems listed, these are SAFE to use to install your child restraint in the vehicle. Review vehicle owner's manual for specific instructions on child restraint installation. **LATCH** can be used IN PLACE OF these vehicle belt types. Refer to your vehicle owner's manual for **LATCH** locations.

Lap Belt with Locking Latch Plate

Once buckled, the vehicle belt is tightened by pulling on the free end of the strap until the belt is tight.



Lap Belt with Automatic Locking Retractor (ALR)

The automatic locking retractor does not allow the lap belt to get longer once it is buckled. The vehicle belt is tightened by feeding seat belt webbing into retractor.

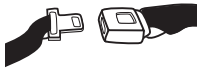

! WARNING! *DEATH or SERIOUS INJURY can occur*

Lap/Shoulder Belt with Locking Latch Plate

The lap portion of this belt does not loosen once the belt is buckled.

The vehicle belt is tightened by pulling up hard on shoulder belt and feeding the extra webbing into the retractor.

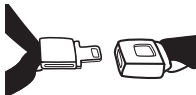

Lap/Shoulder Belt with Sliding Latch Plate with Locking Retractor

The latch plate slides freely along the lap/shoulder belt. Vehicle belts with sliding latch plates are typically locked at the shoulder belt retractor by buckling the belt and pulling all of the webbing out slowly to switch the retractor.

Check vehicle owner's manual for specific instructions. The vehicle belt is tightened after switching the retractor by pulling up on shoulder belt and feeding the webbing into the retractor.

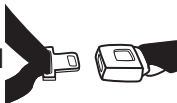

! WARNING! *DEATH or SERIOUS INJURY can occur*

LATCH /UAS Warnings

What is **LATCH**?

LATCH is an acronym for (**L**ower **A**nchors and **T**ethers for **C**hildren) and refers to a pair of fixed Lower Anchors (or bars) and a Top Tether anchor that are built into your vehicle, in vehicles built after September 1, 2002.

The lower **LATCH** anchors are located in the crease, or bight, between the vehicle seat back and seat cushion, and if not visible, will typically be indicated by  symbols. Top tether anchors are located in various places behind the rear vehicle seat.

Vehicle Top Tether Anchor Points

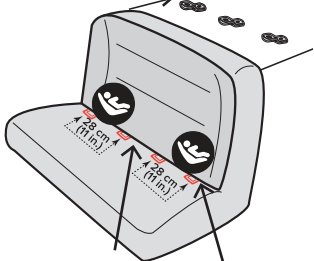

**Vehicle
Seat
Crease**

**Vehicle
Lower
Anchors**

! WARNING! *DEATH or SERIOUS INJURY can occur*

Center installation in a non-standard LATCH  position:

Center installation of this child restraint is permitted using inner Lower Anchor Bars from the outside seating positions if (1) your vehicle manual allows such installation; and (2) the inner Lower Anchor Bars from the outside seating positions are 28-51 cm (11-20 in.) apart.

Is it safer?

LATCH typically offers an easier and more consistent installation. However, this child restraint can be safely installed using either **LATCH** or vehicle belts and meets the requirements of Federal Safety Standard FMVSS 213 with either installation method. Either method is safe for your child when installed correctly.

DO NOT install this child restraint with LATCH and the vehicle's seat belts at the same time. Your vehicle owner's manual may refer to this system as ISOFIX, Universal Anchorage System (UAS), or Lower Universal Anchorage System.

WARNING! *DEATH or SERIOUS INJURY can occur*

LATCH /UAS Warnings

- The LATCH system is intended to be used **ONLY** as described in these instructions. Serious injury or death may result from misuse. Refer to your vehicle Owner's Manual for lower anchor bar positions in your vehicle.
- In addition to these instructions, read and follow your vehicle owner's manual regarding installation of the child restraint and LATCH. If there is a discrepancy, follow your vehicle owner's manual.
- **ONLY** use for securing convenience base to vehicle lower anchor bars.

WARNING! *DEATH or SERIOUS INJURY can occur*



LATCH /UAS Warnings - *continued*

- **NEVER** attach two lower anchor assembly connectors to one vehicle lower anchor bar.
- **NEVER** use the vehicle seat belts when using the lower anchor connector assembly. Using both together can cause slack in a sudden stop or crash.
- When not in use, the lower anchor connector assembly should be securely stored in the storage area located under the convenience base. Keep out of reach of children.
- **ALWAYS** be sure that the lower anchor connectors are fully engaged onto the vehicle anchor bars by pulling hard on the lower anchor connector assembly harness. If they are not totally engaged, the lower anchor connector assembly will not secure your child restraint. Serious injury or death may result.
- **DO NOT** use this child restraint if it moves more than 25 mm (1 in.) side-to-side or front to back at the vehicle belt path. Serious injury or death may result from poor installation. If you can not tightly secure the child restraint, try again or move it to another location.

⚠ WARNING! *DEATH or SERIOUS INJURY can occur*

Usage Warnings

⚠ WARNING



Children have **STRANGLED** in loose or partially buckled harness straps. Fully restrain the child even when carrier is used outside the vehicle.

- **ALWAYS** check the restraint and buckle for hot surfaces before putting a child into the restraint. Your child could be burned.
- In cold weather, **DO NOT** dress the child in bulky clothing, like snowsuits, if the child is riding in a child restraint. This clothing makes it difficult to properly tighten the harness to the child, which may allow the child to be ejected from the restraint during a crash.

! WARNING! *DEATH or SERIOUS INJURY can occur*

Usage Warnings - continued

- **ALWAYS** place the handle in *Position 1 or 3* (U.S. models) or *Position 1* (Canadian models) when using this child restraint in a vehicle (p. 36).
- When using this restraint in *Position 4* (Stand) (p. 38), **ONLY** use on level ground and **NEVER** prop the restraint up with any object.
- **NEVER** place this child restraint on beds, sofas, or other soft surfaces. The child restraint can roll over on soft surfaces and suffocate the child.
- **NEVER** place this child restraint near the edges of counter tops, tables, other high surfaces, or in shopping carts. The child's movements can cause the child restraint to slide and fall.
- The canopy is not intended to provide UV protection.

Safe Practices

- **Everyone rides buckled up or the vehicle does not go.** Make no exceptions for adults or children. If someone unbuckles, stop the vehicle. Being firm and consistent right from the start will mean fewer discipline problems as children get older. Besides, an unrestrained child or adult can be thrown into and injure other passengers.
- **NEVER** try to tend to a crying baby's needs while driving. **NEVER** take a baby out of a child restraint for comforting while the vehicle is moving.
- Always place the handle in *Position 3 or 4* before removing infant from carrier (p. 38).
- **DO NOT** allow a child to have objects such as lollipops or ice cream on a stick. The object can injure the child if the vehicle swerves or hits a bump.
- **DO NOT** feed an infant who is riding in a child restraint.
- Anything loose can be deadly in a crash. Put sharp or heavy items in the trunk.
- **DO NOT** dress the child in blanket sleepers or other clothing that would prevent the crotch strap from fitting snugly up against the child.

For Recall Information for U.S. Customers

- Child restraints could be recalled for safety reasons. You must register this restraint to be reached in a recall. Send your name, address, e-mail address if available, and the restraint's model number, and manufacturing date to:

Evenflo Company, Inc.

1801 Commerce Dr.

Piqua, OH 45356

or call 1-800-233-5921.

or register online at

www.evenflo.com/registercarseat

Tear off and mail this part

<small>Consumer: Just fill in your name and address and e-mail address.</small>		
Your Name _____		
Your Street Address _____		
City _____	State _____	Zip Code _____
E-mail Address _____		
CHILD RESTRAINT REGISTRATION CARD		

- For recall information call the U.S. Government's Vehicle Safety Hotline at 1-888-327-4236 (TTY:1-800-424-9153), or go to: **<http://www.NHTSA.gov>**

Public Notice for Canadian Customers

- Child restraints could be recalled for safety reasons. You must register this restraint to be reached in a public notice. Send your name, address, e-mail address, and the restraint's model number, and manufacturing date to:

Evenflo Company, Inc.

1801 Commerce Dr.

Piqua, OH 45356

or call 1-937-773-3971

or register on-line at

**[www.evenflo.com/
registercarseatcanada](http://www.evenflo.com/registercarseatcanada)**

CANADIAN RESIDENTS ONLY DOMICILIES DU CANADA SEULEMENT		26000187 8/15
PRODUCT REGISTRATION CARD CARTE D'ENREGISTREMENT DU PRODUIT		
1. Name _____ Nom _____		
2. Street Address _____ Adresse _____		
3. City _____	4. Prov. _____	
Ville _____	Prov. _____	
5. Postal Code _____ Code postal _____		
6. Telephone Number (with Area Code) _____ Num. de téléphone (et indicatif régional) () _____		
7. Email Address _____ Adresse électronique _____		
8. Date of Purchase _____ Date d'achat _____		
<small>ATTENTION: This card may be important to the safety of your child. Please complete using blue or black ink and mail this card so that you can be contacted in the event of a safety defect notice on this product. The information you provide must be complete. Or register online at www.evenflo.com/registercarseatcanada.</small>		
<small>ATTENTION : Cette carte pourrait être importante à la sécurité de votre enfant. Veuillez remplir cette carte à l'encre bleue ou noire et la poster afin de pouvoir être contacté en cas d'un avis de défaut lié à la sécurité de ce produit. Les informations fournies doivent être complètes. Ou enregistrez-vous en ligne à www.evenflo.com/registercarseatcanada.</small>		
PLACE DATE/MODEL # LABEL HERE. AFFIXER L'ÉTIQUETTE DE LA DATE ET DU NUMÉRO DE MODÈLE ICI.		

- For public notice information, call Transport Canada at 1-800-333-0510 or go to **www.tc.gc.ca**

When used with the internal harness and properly installed pursuant to these instructions,



this restraint is certified for use only in passenger and multi-purpose passenger motor vehicles, buses and trucks equipped with either lap belts only or lap/shoulder belt systems, and in aircraft.

TIP!

Check with your airline before departure to make sure this restraint meets their requirements.

Refer to pages 101 to 105 for complete instructions on installing your child restraint in aircraft.

Convenience Base with One Step Lock-Off

- 1.** *Angle Indicator*
- 2.** *Level Adjustment Knob*
(Not available on all models)
- 3.** *Leveling Foot*
- 4.** *Lock-Off Release Tab*
- 5.** *One Step Lock-Off*
- 6.** *Vehicle Seat Belt/Lower Anchor
Connector Assembly Belt Path*
- 7.** *Vehicle Belt Clip*
(Not available on all models)
- 8.** *Anti-Rebound Bar*
(Not available on all models)

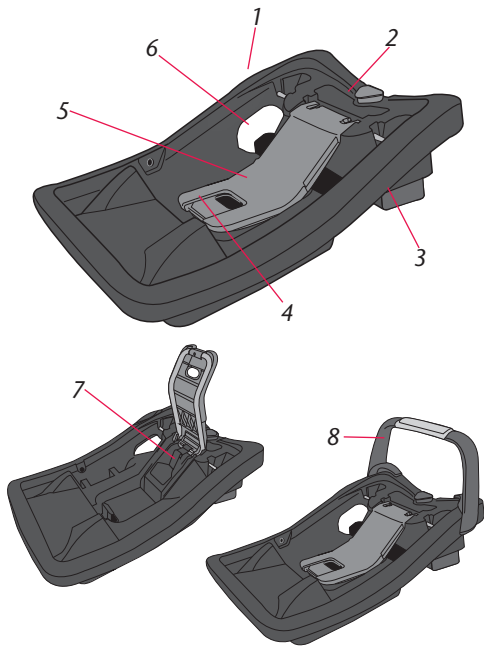

Child Seat Features

1. Handle*
2. Canopy*
3. Seat Pad
4. Body Pillow*
5. Harness Covers*
6. Crotch Buckle
7. Crotch Buckle Cover*
8. Harness Release Button
9. Harness Adjuster Strap
10. Harness Slots
11. Chest Clip
12. Harness Straps
13. Carrier
14. Level Indicator
15. Convenience Base

Front

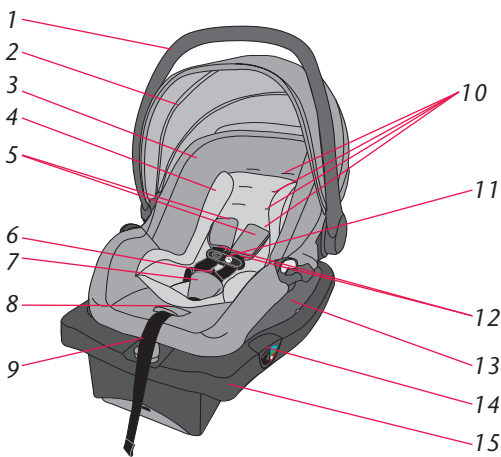

- 16.** Handle Release
- 17.** Harness Straps
- 18.** Splitter Plate
- 19.** Carrier Release Handle
- 20.** Harness Slots
- 21.** Crotch Strap Anchor

** Not all features are available on all models. Styles may vary.*

Back

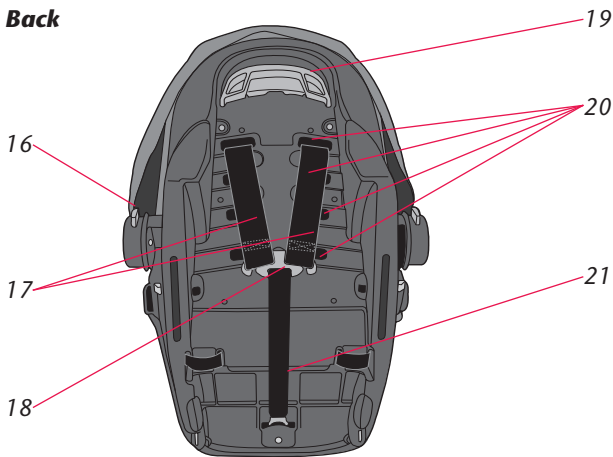

Using the Handle

To change handle positions, squeeze **both Handle Releases** and rotate the handle to the desired position until it locks into place.

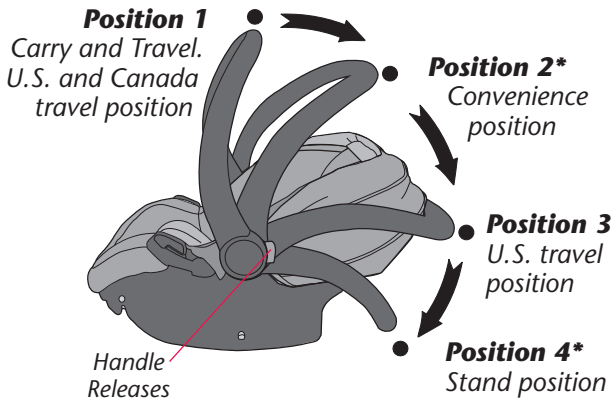

***IMPORTANT: NEVER** use **Positions 2** or **4** when traveling in a vehicle. U.S. and Canadian models differ in acceptable handle positions for travel (see illustration above and page 37-38).

IMPORTANT: *Always* secure the child in the carrier. Refer to “Securing your Child in the Carrier” on page 74- 77.

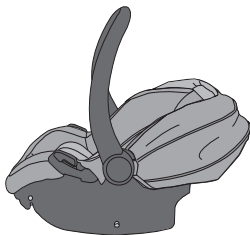

Position 1 (Carry and Travel – U.S. and Canada)

This position is to be used to carry your child. For Canadian models, you **MUST** place the handle in this position when traveling in a vehicle.

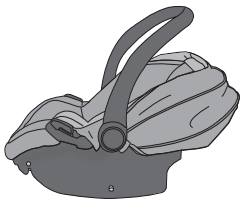

Position 2 (Convenience)
NEVER use this position to carry your child in the carrier. **NEVER** use this position in the vehicle.

Using the Handle (cont.)

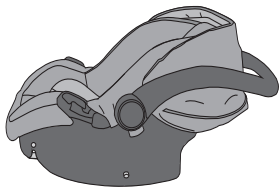

Position 3 (Travel – U.S.)

For U.S. models, you may place the handle in this position while traveling in a vehicle.

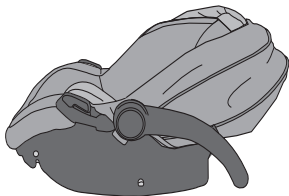

Position 4 (Stand)

Place the handle in this position when you set the carrier on the floor. **NEVER** use this position in a vehicle.

Proper Installation WITH the Convenience Base

Child Requirements

- **Weight:** 1.8 – 15.8 kg (4 – 35 lbs)
- **Height:** 43 – 81 cm (17 – 32 in.) and top of child's head is at least 25 mm (1 in.) below the top of the child restraint seat back.

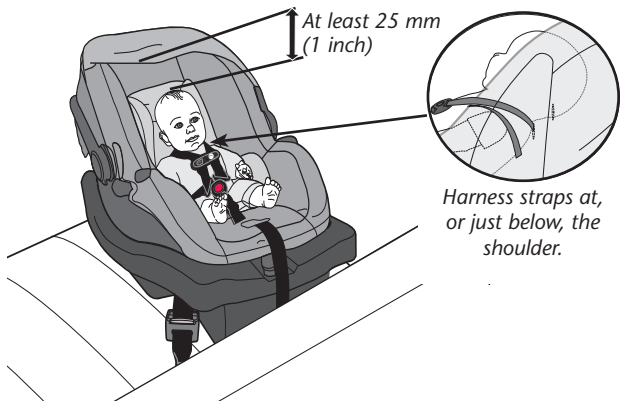

Harness straps at, or just below, the shoulder.

IMPORTANT: Once your child **exceeds** any of the size requirements above, they **MUST** discontinue use of this child restraint.

Installation Checklist

1. Secure convenience base to the vehicle seat.

- ✓ Convenience base is securely installed with lower anchor connector assembly (shown) (pages 42-52).

OR

- ✓ Convenience base is securely installed with vehicle seat belt (pages 53-60).

IMPORTANT: A properly secured convenience base does **NOT** move more than 25 mm (1 in.) from side-to-side or from front-to-back **at the lower anchor connector assembly/vehicle belt path.**

- ✓ Convenience base is adjusted so that level indicator is in correct color zone for your child (pp. 44 and 53).
- ✓ If necessary, a towel/small blanket is rolled up and placed beneath the front edge of the base for additional leveling (p. 62).

Installation Checklist (cont.)

2. Secure child to the carrier. Refer to p. 74.

- ✓ Harness straps are at, or below, shoulder level (p. 39).
- ✓ Both buckle tongues are fastened (p. 75).
- ✓ Chest clip is connected and positioned at armpit level (p. 76).
- ✓ Harness straps are snug against the child and you should not be able to pinch the harness (p. 76).
- ✓ Crotch strap is snug against the child but **NOT** under the child's bottom (p. 83).
- ✓ Waist straps are snug against the child but **NOT** under the child's legs (p. 87).

3. Check your work.

- ✓ The convenience base does **NOT** move more than 25 mm (1 in.) from side-to-side or from front-to-back **at the lower anchor connector assembly/vehicle belt path.**
- ✓ The base is level when level indicator is in the correct color zone for your child (pp. 44 and 53).
- ✓ The handle is in *Position 1* or 3 (U.S. models **ONLY**), or *Position 1* (Canadian models **ONLY**) (p. 36).



Installing the Convenience Base with the Lower Anchor Connector Assembly (cont.)

! WARNING! *DEATH or SERIOUS INJURY can occur*

- This lower anchor connector assembly is intended to be used **ONLY** as described in these instructions. Serious injury or death may result from misuse.
- In addition to these instructions, read and follow your vehicle owner's manual regarding installation of the child restraint and LATCH. If there is a discrepancy, follow your vehicle owner's manual.
- **ONLY** use for securing convenience base to vehicle lower anchor bars.
- **NEVER** attach two lower anchor assembly connectors to one vehicle lower anchor bar.
- **NEVER** use the vehicle seat belts when using the lower anchor connector assembly. Using both together can cause slack in a sudden stop or crash.
- When not in use, the lower anchor connector assembly should be securely stored in the storage area located under the convenience base or on the side of the base (see page 97). Keep out of reach of children.



Installing the Convenience Base with the Lower Anchor Connector Assembly (cont.)

! WARNING! *DEATH or SERIOUS INJURY can occur*

- **ALWAYS** be sure that the lower anchor connectors are fully engaged onto the vehicle lower anchor bars by pulling hard on the lower anchor connector assembly harness. If they are not totally engaged, the lower anchor connector assembly system will not secure your child restraint. Serious injury or death may result.
- **DO NOT** use this child restraint if it moves more than 25 mm (1 in.) side-to-side or front to back at the vehicle belt path. Serious injury or death may result from poor installation. If you can not tightly secure the child restraint, try again or move it to another location.
- This child restraint **MUST** face the rear of the vehicle.
- The carrier **MUST** be locked firmly into the base. Check by lifting up on the carrier.
- **NEVER** use this child restraint in the forward-facing position.



Installing the Convenience Base with the Lower Anchor Connector Assembly (cont.)

- 1** Before you begin, be sure the vehicle is on a level ground. Remove lower anchor connectors, see page 95-96. Place base rear-facing on an approved vehicle seat location.

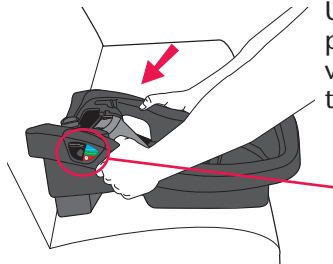

Using your full weight, push the base into the vehicle seat and check the level indicator.

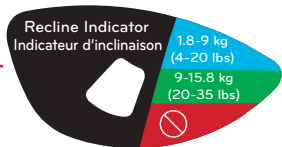

White indicator line **MUST** be in the correct color zone for your child.

**Blue: 1.8 - 9 kg
(4 - 20 lbs)**

**Green: 9 - 15.8 kg
(20 - 35 lbs)**

Note: NEVER allow white indicator line to appear in red zones.



Installing the Convenience Base with the Lower Anchor Connector Assembly (cont.)

The Leveling Foot that comes with your child restraint will be one of the following types (**2a** or **2b**).

2a

Knob

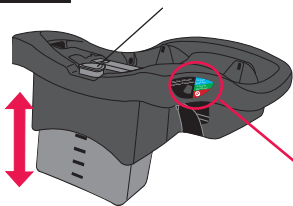

Recline base until white indicator line is in the correct color zone for your child.

Turn adjustment knob to raise or lower the adjustment foot.

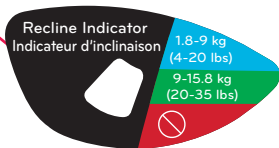

Note: **NEVER** allow white indicator line to appear in red zones.



Installing the Convenience Base with the Lower Anchor Connector Assembly (cont.)

2b

Note: If you need to use the leveling foot, follow these steps.

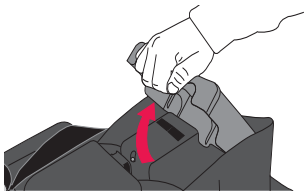

Turn base over and rotate leveling foot up, as shown.

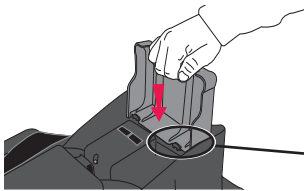

Push leveling foot down until the locking tabs snap in place, as shown.

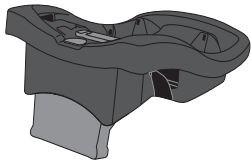

Base shown with leveling foot extended.



Installing the Convenience Base with the Lower Anchor Connector Assembly (cont.)

Note: To store the leveling foot, follow these steps.

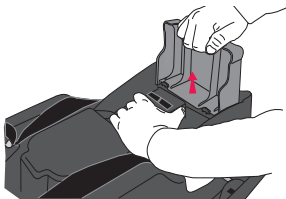

Turn base over. While holding the base down with one hand, pull leveling foot up to disengage the locking tabs.

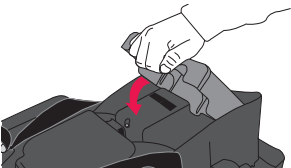
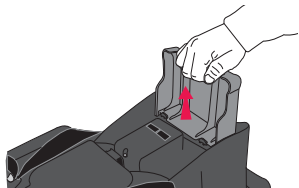

Rotate leveling foot to stored position.



Installing the Convenience Base with the Lower Anchor Connector Assembly (cont.)

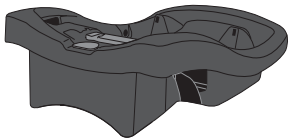

Base shown with leveling foot in stored position.

3

Turn the convenience base upside down. Depending on your model, the Lower Anchorage Storage will be under the base or on the sides of the base. Remove both lower anchor hooks or clips, see page 95-96.



OR



OR





4 **Open One Step Lock-Off**

Turn the convenience base right side up. Push down on Lock-Off while pushing back on Lock-Off Release Tab. Lift the Lock-Off up to reveal the belt path.

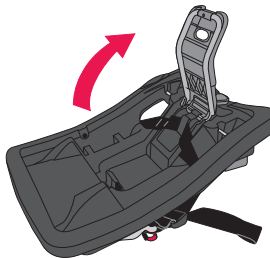
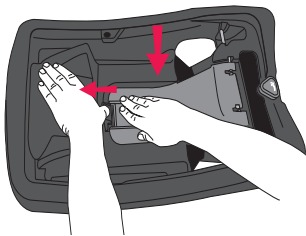



Installing the Convenience Base with the Lower Anchor Connector Assembly (cont.)

5

Know Your Lower Anchor Connector Assembly

The lower anchor connector assembly that comes with your child restraint will be one of the types below.

SecureRight

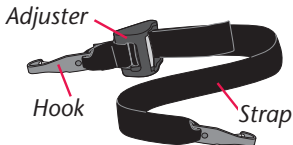

OR

Quick Connector

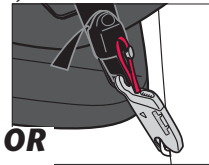
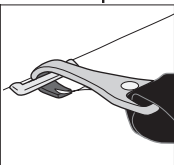
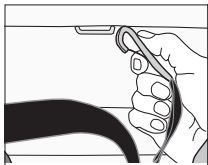
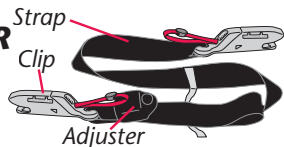

Refer to your vehicle owner's manual to locate the lower anchor bars on your vehicle seat. Attach the right hook, or clip, to the right anchor bar and the left hook, or clip, to the left anchor bar. **DOUBLE CHECK** that the lower anchor connector hook, or clip, is fully engaged by pulling hard on the lower anchor connector strap.



Installing the Convenience Base with the Lower Anchor Connector Assembly (cont.)

6



Using your full weight, push the base into the vehicle seat, while pulling up on the strap to remove all slack from the lower anchor connector assembly.

7

Close One Step Lock-Off

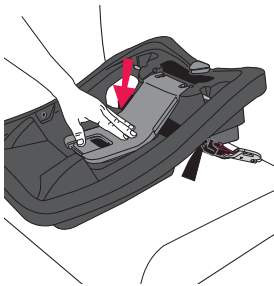

Place any excess lower anchor connector webbing to the side of the base. Do Not route it back under the Lock-off. Close the Lock-Off until it clicks into place.

Note: If unable to close the Lock-Off, loosen the lower anchor connector assembly, and try again.



Installing the Convenience Base with the Lower Anchor Connector Assembly (cont.)

! WARNING! *DEATH or SERIOUS INJURY can occur*

8

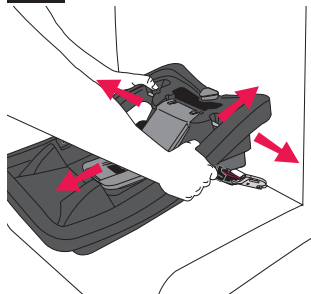

Make sure the lower anchor connector assembly harness is tight. Grab the base at the areas, as shown. If you can move the base more than 25 mm (1 in.) side-to-side or front to back, the harness is not tight enough. You will need to try again, or find another location for your convenience base.

Place carrier on base, re-check level , see page 61-62.

To remove lower anchor connector, see page 95.



Installing the Convenience Base with the Vehicle Seat Belt

Before you begin, be sure the vehicle is on level ground. Store the lower anchor connectors, see page 96-97.

1

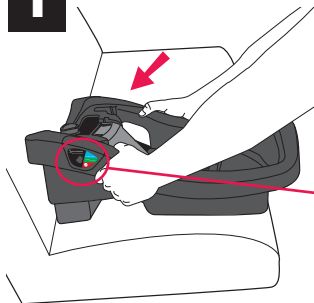

Using your full weight, push the base into the vehicle seat and check the level indicator.

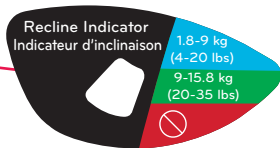

**Blue: 1.8 - 9 kg
(4 - 20 lbs)**

**Green: 9 - 15.8 kg
(20 - 35 lbs)**

White indicator line **MUST** be in the correct color zone for your child.

Note: NEVER allow white indicator line to appear in red zones.



Installing the Convenience Base with the Vehicle Seat Belt (cont.)

The Leveling Foot that comes with your child restraint will be one of the following types (**2a** or **2b**).

2a

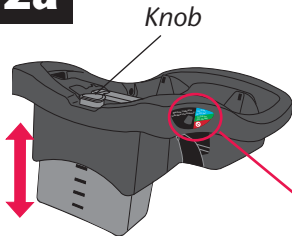

Recline base until white indicator line is in the correct color zone for your child.

Recline Indicator
Indicateur d'inclinaison

1.8-9 kg
(4-20 lbs)

9-15.8 kg
(20-35 lbs)



Turn adjustment knob to raise or lower the adjustment foot.

Note: NEVER allow white indicator line to appear in red zones.



Installing the Convenience Base with the Vehicle Seat Belt (cont.)

2b

Note: If you need to use the leveling foot, follow these steps.

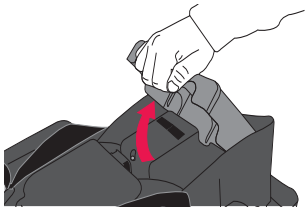

Turn base over and rotate leveling foot up, as shown.

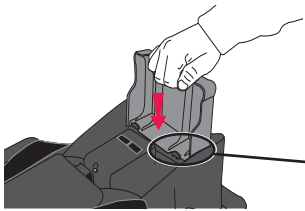

Push leveling foot down until the locking tabs snap in place, as shown.

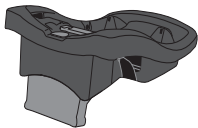

Base shown with leveling foot extended.



Installing the Convenience Base with the Vehicle Seat Belt (cont.)

Note: To store the leveling foot, follow these steps.

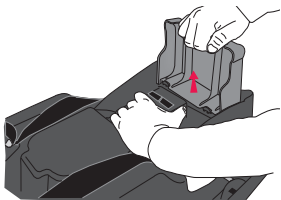

Turn base over. While holding the base down with one hand, pull leveling foot up to disengage the locking tabs.

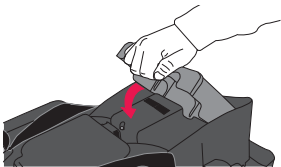
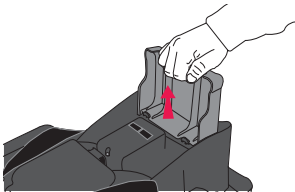

Rotate leveling foot to stored position.



Installing the Convenience Base with the Vehicle Seat Belt (cont.)

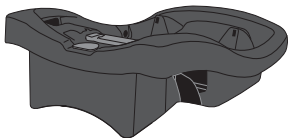

Base shown with leveling foot in stored position.

- 3** *The Lock-Off provides a way to lock the child restraint without needing to lock your vehicle seat belt. (Refer to Vehicle's Owners Manual for vehicle seat belt use.)*

Open One Step Lock-Off

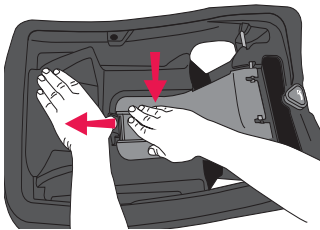

Push down on Lock-Off while pushing back on Lock-Off Release Tab. Lift the Lock-Off up to reveal the belt path.



Installing the Convenience Base with the Vehicle Lap/Shoulder Belt

4

Secure the base to your vehicle seat by routing the **lap/shoulder belt** through the belt path openings on the sides of the base and through the vehicle belt clip. **Fasten the buckle.**



LAP / SHOULDER BELT

Pull the shoulder belt tightly to remove all slack from the lap portion of the belt, at the same time use your full weight to push down on the base.

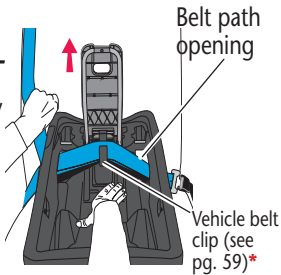

Note: If seat belt Stop Button interferes with the Lock-Off, shift base to the left or right in order to prevent interference.

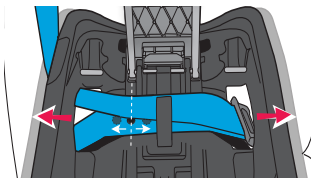



Installing the Convenience Base with the Vehicle Lap Belt (cont.)

5

Secure the base to your vehicle seat by routing the **lap belt** through the belt path openings on the sides of the base and through the vehicle belt clip. **Fasten the buckle.**



LAP BELT

Pull the seat belt tightly to remove all slack from the lap portion of the belt, at the same time use your full weight to push down on the base.

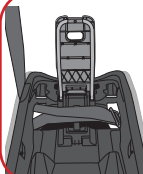
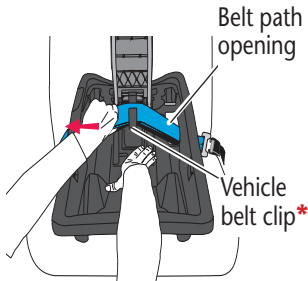

*IMPORTANT!

For models without Vehicle Belt Clip, route lap/shoulder belt or lap belt as shown.

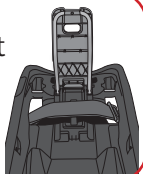



Installing the Convenience Base with the Vehicle Seat Belt (cont.)

6

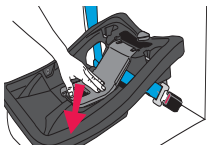

Close the Lock-Off until it clicks into place.

7

⚠ WARNING!

DEATH or SERIOUS INJURY can occur

Make sure the vehicle belt is tight. Grab the base at the areas, as shown. If you can move the base more than 25 mm (1 in.) side-to-side or front to back the vehicle belt is not tight enough. You will need to try again, or find another location for your convenience base.

LAP / SHOULDER BELT

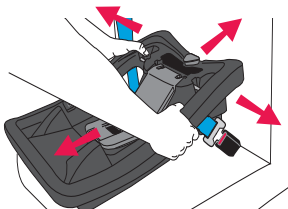

LAP BELT

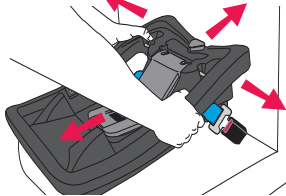

! WARNING! *DEATH or SERIOUS INJURY can occur*

1

- **NEVER** use this child restraint in the forward-facing position.

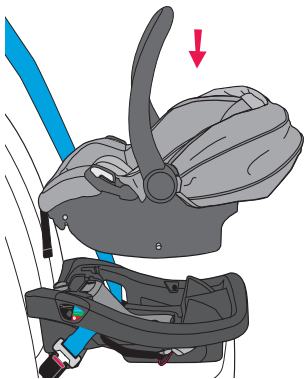

Secure the carrier to the base by placing it into the base and pressing down on the front and back.

The carrier *MUST* be locked firmly into the base. Check by lifting up on the carrier handle to make sure it's locked in place.

Placing the Carrier in the Base (cont.)

2

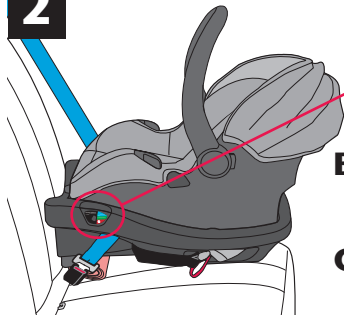

Recline Indicator
Indicateur d'inclinaison

1.8-9 kg
(4-20 lbs)

9-15.8 kg
(20-35 lbs)

**Blue: 1.8 - 9 kg
(4 - 20 lbs)**

**Green: 9 - 15.8 kg
(20 - 35 lbs)**

The level indicator must be in the correct color zone for your child. If you have fully adjusted the convenience base and the level indicator is still not level, use a tightly rolled towel or small blanket beneath the front edge of the base.

IMPORTANT: *Infants may have difficulty breathing when in a sitting position. Make sure they recline enough for their head to lie back comfortably and safely. Failure to properly recline the child restraint could increase the child's risk of serious injury or death.*

Placing the Carrier in the Base (cont.)

3 U.S. Models **ONLY** Position 1 or 3

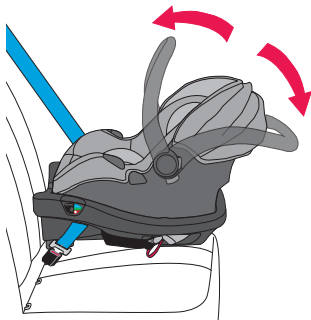

Canadian Models **ONLY** Position 1

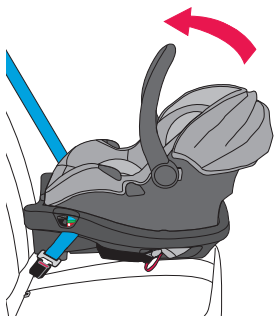

Squeeze both handle releases and move the handle to the travel position:

Position 1 or 3 (U.S. models **ONLY)**

OR

Position 1 (Canadian models **ONLY)**

until it locks in place.

Releasing the Carrier from the Base

Move the handle to **Position 1 (Carry)** by squeezing in on both handle releases and rotating the handle until it locks into place above the carrier.

Squeeze the carrier release handle while lifting up the carrier.

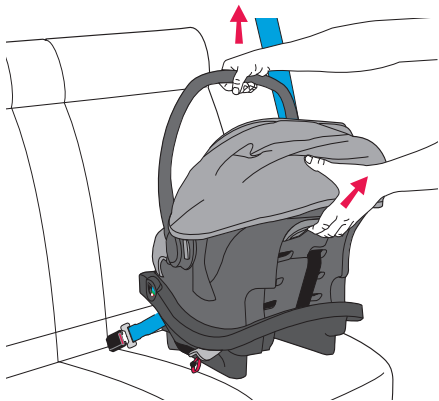

To remove base, unfasten the vehicle belt then open the lock-off.

Proper Installation *WITHOUT* the Convenience Base

Child Requirements

- **Weight:** 1.8 – 15.8 kg (4 – 35 lbs)
- **Height:** 43 – 81 cm (17 – 32 in.) and top of child's head is at least 25 mm (1 in.) below the top of the child restraint seat back.

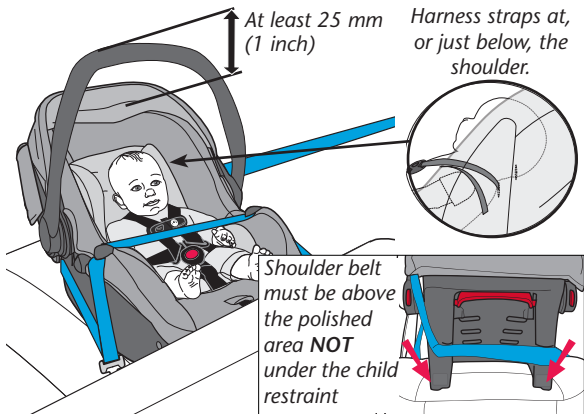

IMPORTANT: Once your child **exceeds** any of the size requirements above, they **MUST** discontinue use of this child restraint.

Installation Checklist

1. Place the child in the carrier.

- ✓ The child's back and bottom are flat against the back and bottom surfaces of the carrier.
- ✓ Top of child's head is at least 25 mm (1 in.) below the top of the child restraint seat back.

2. Secure child to the carrier. Refer to p. 74.

- ✓ Harness straps are at, or just below, shoulder level (p. 65).
- ✓ Both buckle tongues are fastened (p. 75).
- ✓ Chest clip is connected and positioned at armpit level (p. 76).
- ✓ Harness straps are snug against the child and you should not be able to pinch the harness (p. 76).
- ✓ Crotch strap is snug against the child, but **NOT** under the child's bottom (p. 83).
- ✓ Waist straps are snug against the child, but **NOT** under the child's legs (p. 87).

Installation Checklist

3. Secure child restraint to the vehicle seat.

- ✓ Carrier is securely installed with vehicle seat belt (p. 69-72).
- ✓ The shoulder strap portion of the seat belt is above the polish area on rear of child restraint (p. 69).
- ✓ Locking clip is installed, if necessary (p. 73).
- ✓ The level line is level with ground (p. 68).
- ✓ The handle is in *Position 1* or 3 (U.S. models **ONLY**), or *Position 1* (Canadian models **ONLY**) (p. 36)
- ✓ If necessary, a towel/small blanket is rolled up and placed beneath the front edge of the carrier so the child's head lies back comfortably (p. 72).

4. Check your work.

- ✓ To properly protect your child, the carrier **MUST NOT** move more than 25 mm (1 in.) from side-to-side or from front-to-back **at the vehicle belt path.**



Installing the Carrier WITHOUT the Convenience Base

1

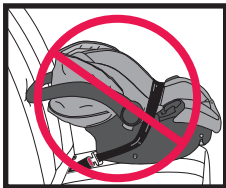
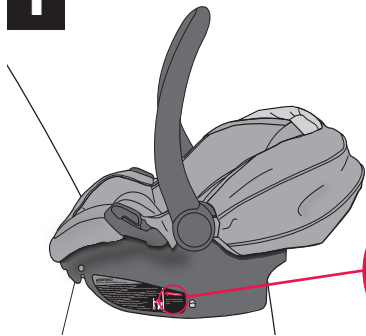

After securing the infant, place the restraint into your vehicle. Adjust the restraint so that the level line is level with the ground.

Note: Generally, the center rear seating position is the safest. **This infant restraint *MUST* face the rear of the vehicle.**

2

LAP BELT

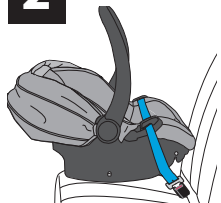

Route **ONLY** the **lap portion** of the vehicle seat belt through the vehicle belt slots on the carrier, **then fasten buckle.**

LAP/ SHOULDER BELT

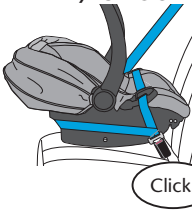

In vehicles with a **lap/shoulder belt**, **DO NOT** route the shoulder belt through the belt slots.

Instead, put the lap belt through the belt guides, then wrap the shoulder belt around the back as shown, **then fasten buckle.**

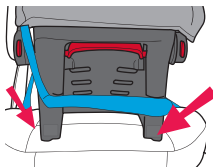

Shoulder belt must be above the polished area **NOT** under the child restraint.

IMPORTANT: Some ELR vehicle belts can be switched so that they lock when tightened. It may not be necessary to use a locking clip in these situations. To obtain and install a locking clip, refer to p. 73. Refer to the vehicle owner's manual to determine which type of belt retractor is in the vehicle.



Installing the Carrier WITHOUT the Convenience Base

3 **! WARNING!**

DEATH or SERIOUS INJURY can occur

- **NEVER** use this child restraint in forward-facing position.
- **DO NOT** use this carrier if it moves more than 25 mm (1 in.) side-to-side or front to back at the vehicle belt path. Serious injury or death may occur. Move the child restraint to another seating location, or try to tighten the vehicle belt again.

TIP!

Push down on the bottom of the seat using your full weight.

Shoulder belt routes above the handle on the opposite side of seat.

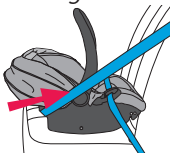
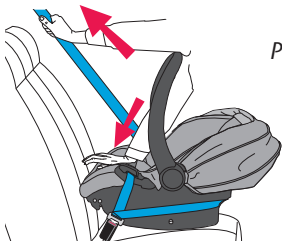

The vehicle belt must be as tight as possible. Put your full weight into the seat as you tighten the vehicle belt. If you can move the child restraint more than 25 mm (1 in.) side-to-side or front to back at the vehicle belt path, the vehicle belt is not tight enough, and you need to try again.



4

U.S. Models ONLY

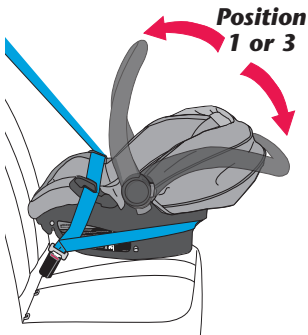

Canadian Models ONLY

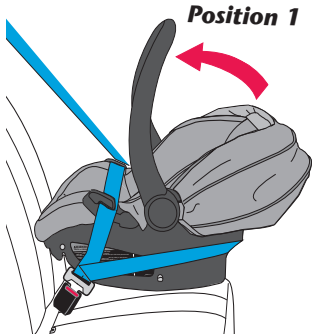

Squeeze both handle releases and move the handle to the travel position:

Position 1 or 3 (U.S. models ONLY)

OR

Position 1 (Canadian models ONLY)

until it locks in place.



Installing the Carrier WITHOUT the Convenience Base

5

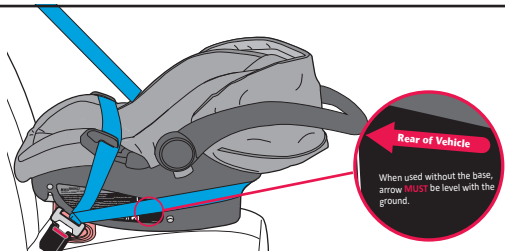

If the level line is not level with the ground, use a tightly rolled towel or small blanket beneath the front edge of the child restraint to provide enough recline for an infant's head to lie back comfortably.

IMPORTANT: *Infants may have difficulty breathing when in a sitting position. Make sure they recline enough for their head to lie back comfortably and safely. Failure to properly recline the child restraint could increase the child's risk of serious injury or death.*

To remove, unfasten the vehicle belt.



Installing the Carrier WITHOUT the Convenience Base

6

Locking Clip
installed
properly
13 mm
(0.5 in.)

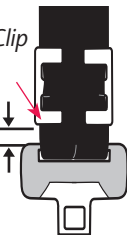

Install Locking Clip (not included), if necessary.

If your vehicle was built **prior to model year 1996**, and has a lap/shoulder belt that is equipped with an emergency locking retractor (ELR) AND sliding latch plate, you **MUST** use a Locking Clip.

Check your vehicle owner's manual to identify which vehicle belt system is in your vehicle. If your vehicle is **model year 1996 or newer**, it likely has a vehicle belt system that can be locked when tightened, and will not require use of a Locking Clip.

Consult your vehicle owner's manual before installing a locking clip.

If your vehicle requires a Locking Clip, please call ParentLink at 1-800-233-5921 (U.S.) or 1-937-773-3971 (Canada), or 01-800-706-12-00 (Mexico) to obtain a Locking Clip and instructions on how to install and use it.

! WARNING! DEATH or SERIOUS INJURY can occur

- Remove Locking Clip from vehicle seat belt when not used with a child restraint, or the vehicle seat belt will not properly restrain an adult or child. Serious injury could occur.

Securing the Child in the Carrier



Place the baby into the carrier. Baby's bottom and back should be flat against the seat. If there is a gap, baby will not be comfortable.

1

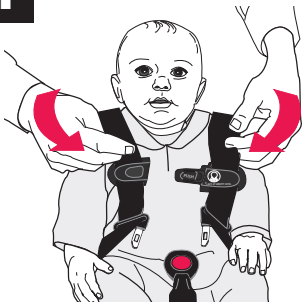

Slide each harness strap over the child's shoulders.

2

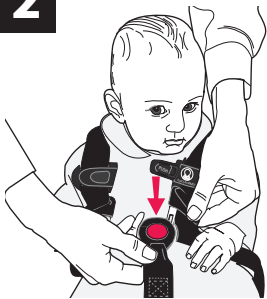

Insert the buckle tongues into the buckle. Pull up on the harness straps to ensure the buckle tongues are engaged.

IMPORTANT: The crotch strap should **ALWAYS** be as close as possible to, but **NEVER** under, the child's bottom. Adjust the crotch strap if necessary (p. 83). The waist straps should **ALWAYS** be as close as possible to, but **NEVER** under, the child's legs. Adjust the waist straps if necessary (p. 87).

Securing the Child in the Carrier (cont.)

3

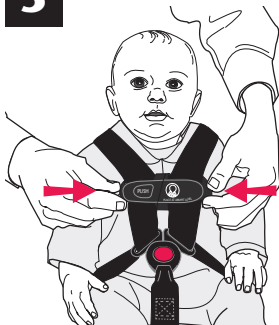

Align the two sides of the chest clip and snap them together. The chest clip must be positioned at armpit level.

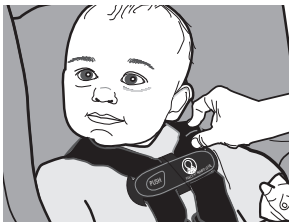

The harness straps must be snug against the child. A snug strap should not allow any slack. It lies in a relatively straight line without sagging. It does not press on the child's flesh or push the child's body into an unnatural position. Check the harness straps near the shoulders for slack. You should **NOT** be able to pinch the harness (see illustration). Adjust as needed.

4

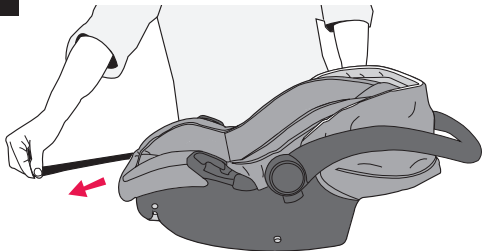

To tighten the harness straps, pull the harness adjuster strap on front of the restraint, as shown.

Removing the Child from the Carrier

1



Press the red buckle release, and remove the buckle tongues.

2

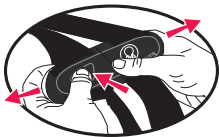

Push the release button and pull the chest clip apart.

3

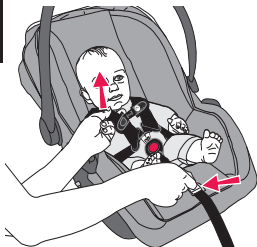

To loosen the harness straps, press the harness release button while pulling upward on the harness straps.

Changing the Harness Position

As your child grows, you will need to change the harness strap position so they are routed through the slots closest to the child's shoulders. The shoulder harness straps should **ALWAYS** be as close as possible to, but **NEVER** above the child's shoulders.

1

Loosen the harness straps by pressing the harness release button while pulling on the straps.

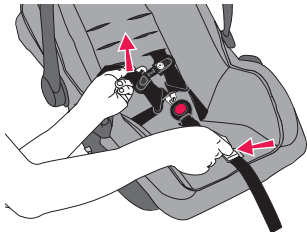

2

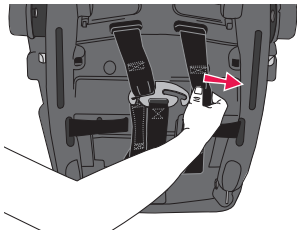

Slide the harness strap off of the splitter plate.

Changing the Harness Position

3

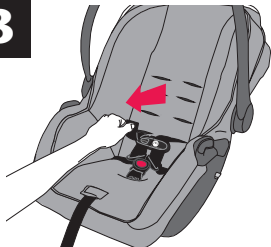

Pull both harness straps through the front of the child restraint.

4



Insert both harness straps into the new harness position slots.

IMPORTANT: When inserting harness straps through the slots in the seat pad, make sure you route them correctly through their corresponding slots in the seat shell.

5 **! WARNING!**

DEATH or SERIOUS INJURY can occur

Make sure both harness straps are installed **completely** on the splitter plate, as shown. Failure to properly attach the harness straps to the splitter plate may result in a loose harness and serious injury or death to your child.

Newborn



Infant

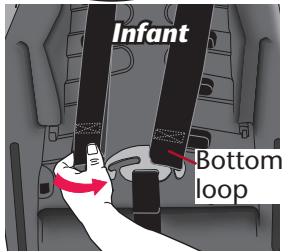
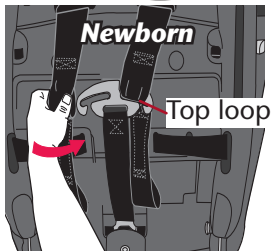

There are two positions on the harness straps. The top loop is for newborn use. The bottom loop is for use as your child grows. Reattach the harness strap onto the splitter plate. Repeat on the other side.

Changing the Harness Position (cont.)

6

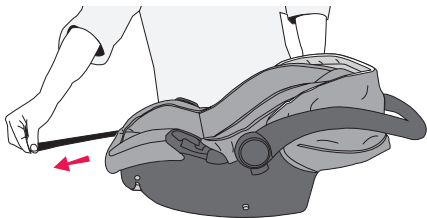

Tighten the harness straps by pulling the adjustment strap on front of the restraint.

Note: Final adjustment of the harness straps must be completed with the baby in the child restraint.

Changing the Crotch Strap Position

As your child grows, you will need to change the crotch strap position so that it is in the slot closest to your child. The crotch strap should **ALWAYS** be as close as possible to, but **NEVER** under, the child's bottom.

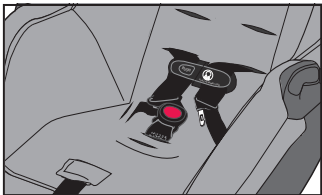
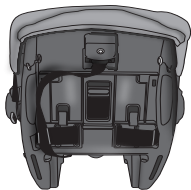

Crotch Strap in the Newborn Position

NEVER use this position for children weighing more than 3.6 kg (8 lbs).

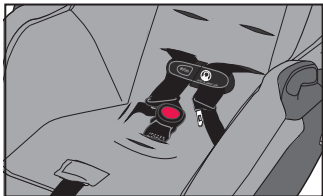
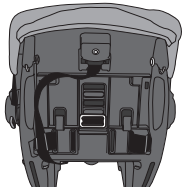

Crotch Strap in the Rear Slot

Changing the Crotch Strap Position (cont.)

Crotch Strap in the Middle Slot

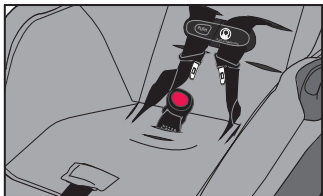
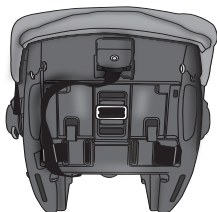

Crotch Strap in the Front Slot

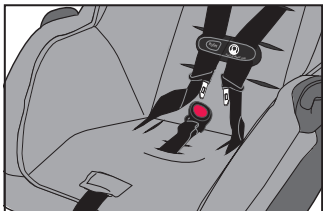
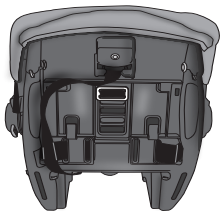

Changing the Crotch Strap Position (cont.)

1

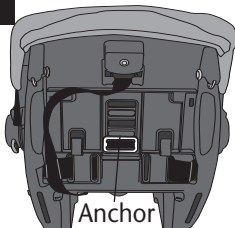

To reposition crotch strap, loosen the harness straps (p. 78) and move the strap out of the way.

Remove the crotch strap anchor from its position on the bottom of the carrier, and push the anchor up through the slot to the top of the seat.

2

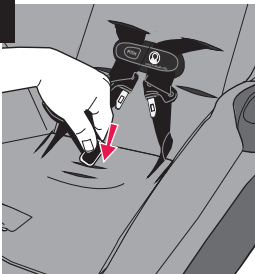

Insert the crotch strap anchor into the slot that is the closest to the child, but **NEVER** under the child's bottom.

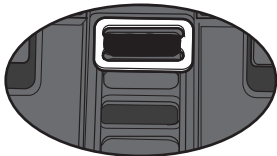

Make sure the anchor is completely through and is lying flat against the bottom of the seat. Pull up on the crotch strap to make sure it is securely fastened.

Changing the Crotch Strap Position (cont.)

3

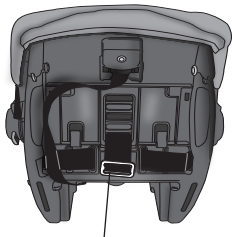

Anchor

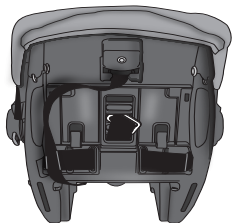

For newborn position, place the anchor through the rear slot, then feed it through the middle or front slot.

Make sure the anchor is completely through the middle or front slot and is lying flat against the bottom of the seat.

NEVER use this position for children weighing more than 3.6 kg (8 lbs).



Rear to Middle



Rear to Front

Changing the Waist Strap Position

As your child grows, you will need to change the waist strap position so that it is in the slot closest to your child. The waist strap should **ALWAYS** be as close as possible to, but **NEVER** under, the child's legs.

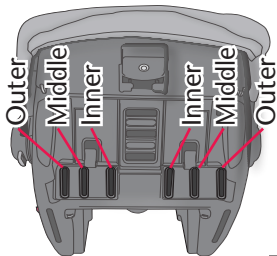

Approximate
Child Size:

Waist Strap
Position:

Small	1.8 - 2.7 kg (4 - 6 lbs)	Inner
Medium	2.7 - 9 kg (6 - 20 lbs)	Middle
Large	9 - 15.8 kg (20 - 35 lbs)	Outer

Changing the Waist Strap Position (cont.)

1

To reposition waist straps, loosen the harness straps by pressing the harness release button while pulling on the harness straps.

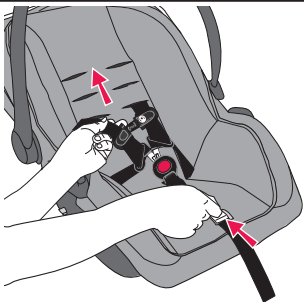

2

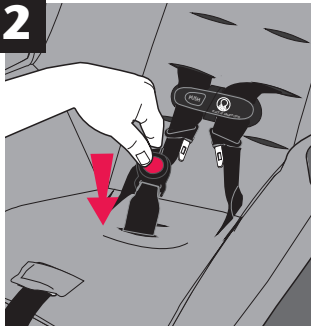

Push the crotch strap through the slot in the seat pad



Anchor

Changing the Waist Strap Position (cont.)

3

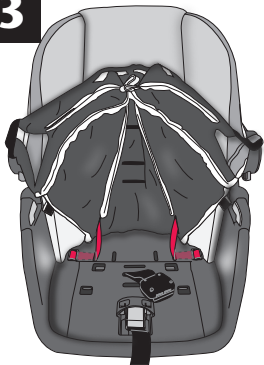

Unhook the front of the child restraint's seat pad and move it out of the way to expose the waist strap slots and anchors.

Remove the waist strap anchor from its position on top of the seat, and push the anchor down through the slot to the bottom of the seat. Then push anchor up through the slot to the top of the seat pad. Repeat on other side.

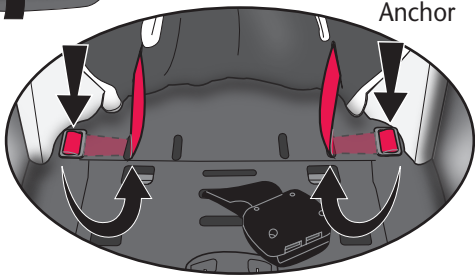

Changing the Waist Strap Position (cont.)

4

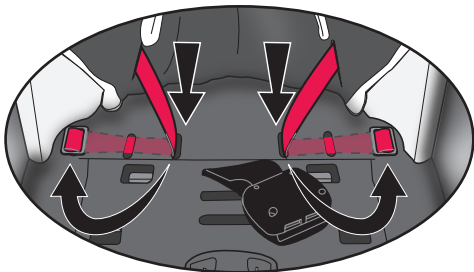

Push the anchor down through the appropriate slot to the bottom of the seat. Then push anchor up through the appropriate slot to the top of the seat.

Note: See images (pp. 91 and 93) to find the appropriate waist strap slots for your child's size.

Changing the Waist Strap Position (cont.)

Small size baby

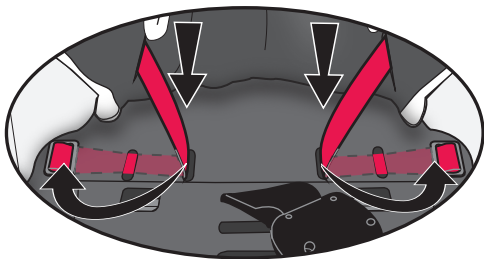

Small size baby

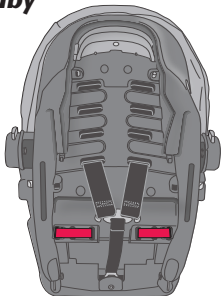
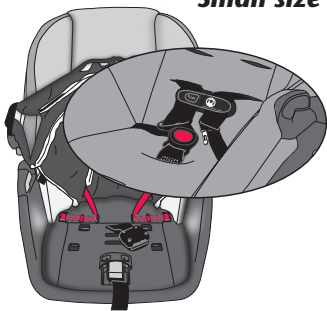

Changing the Waist Strap Position (cont.)

Medium size baby

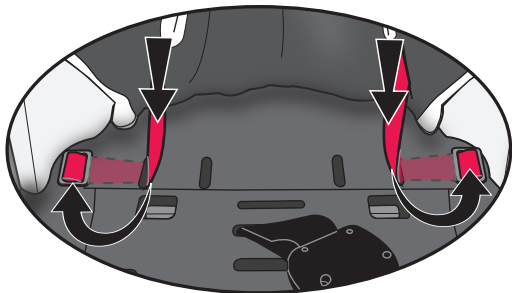

Medium size baby

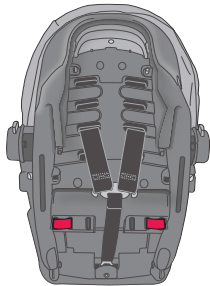
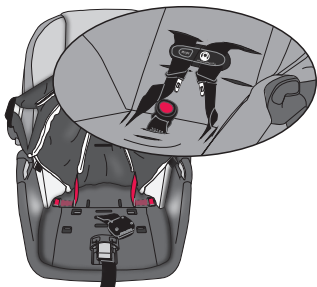

Changing the Waist Strap Position (cont.)

Large size baby

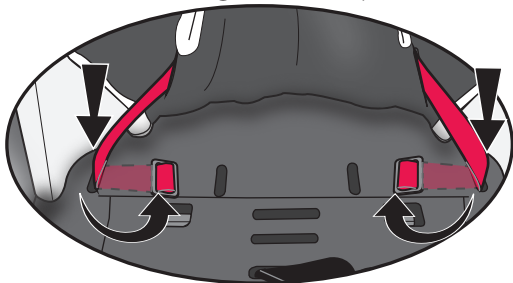

Large size baby

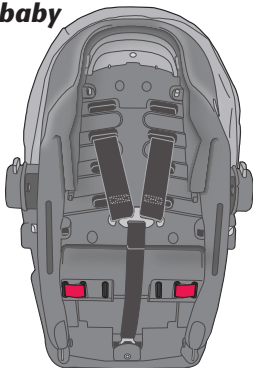
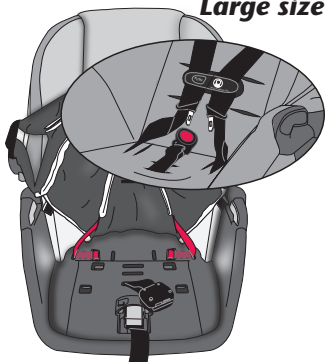



Removing the Lower Anchor Connector Assembly

- 1 Tilt and slide the adjuster to loosen the lower anchor connector assembly.

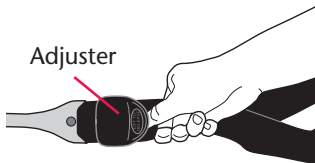

OR

Press the adjuster release button to loosen the lower anchor connector assembly

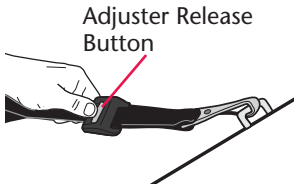



Removing the Lower Anchor Connector Assembly (cont.)

2

The lower anchor connector that comes with your child restraint will be one of the types below:

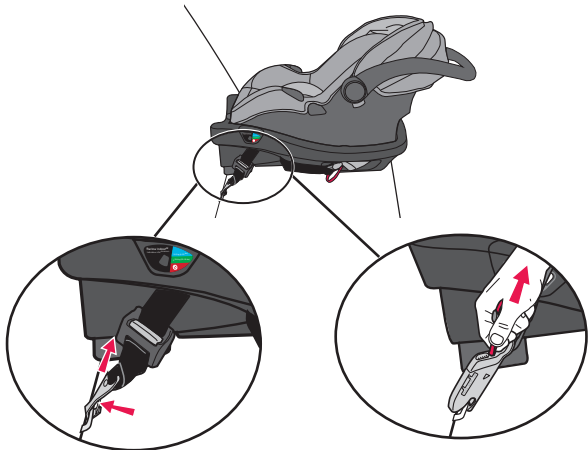

To remove the hook, press the tab and twist, then remove from anchor.

To remove the clip, pull the red release strap and remove clip from anchor.



Removing the Lower Anchor Connector Assembly (cont.)

- 3** When the lower anchor connector assembly is not in use, you **MUST** securely store it in the area provided on the bottom or side of the base depending on which style base you have. Make sure the lower anchor connector assembly strap is routed through the belt path on top of the base.

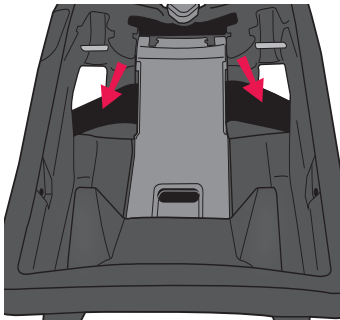



Removing the Lower Anchor Connector Assembly (cont.)

Depending on your model, attach the hooks or clips to the posts located on each side of the base or on the bottom of the base.

A loose lower anchor assembly connector harness and hook may injure your child.



OR



OR



Using as an Infant Carrier

Secure the child in the carrier by following “Securing the Child in the Carrier” on page 74.

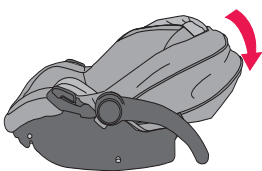

Position 4

To use as a stand: Squeeze both handle releases and rotate the handle to **Position 4 (Stand)** until it locks into place and the carrier rests on a level surface.

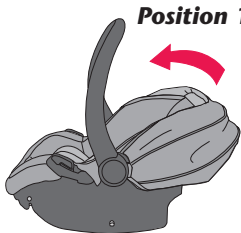

Position 1

To use as a carrier: Squeeze both handle releases and rotate the handle to **Position 1 (Carry)** until it locks into place. Carry at your side, using the handle as shown.

IMPORTANT

The harness **MUST** be securely buckled **at all times**.



! WARNING! *DEATH or SERIOUS INJURY can occur*

- **NEVER** place this carrier near the edges of counter tops, tables, or other high surfaces. The child's movements can cause the carrier to slide and fall.
- **NEVER** leave the child in this carrier when the harness straps are loose or undone. Children have **STRANGLED** in loose or partially buckled harness straps. Fully restrain the child even when carrier is outside the vehicle.
- **Fall Hazard:** The carrier can fall from the shopping cart. Do not use on shopping cart.



-
- **DO NOT** carry on your hip.





Securing Your Child Restraint in Aircraft

The Federal Aviation Administration (FAA) recommends that you secure your child for air travel in an appropriate child restraint based on your child's weight and size. Turbulence can happen with little or no warning. When turbulence occurs, **the safest place for your child is in a properly installed child restraint, not in an adult's lap or on the aircraft seat with its seat belt.** Keeping your child in a child restraint during the flight will help ensure your family arrives safely at your destination.

The FAA recommends that a child weighing:

- more than 18 kg (40 lbs) use an aircraft seat belt;
- less than 9 kg (20 lbs) use a rear-facing child restraint; and
- from 9 to 18 kg (20 to 40 lbs) use a forward-facing child restraint.

Please note that these FAA recommendations may vary from those applicable to the use of your child restraint in a motor vehicle.

IMPORTANT

You must use the internal harness when installing the child restraint in aircraft.

*Before installing the child restraint, make sure the **aircraft seat is in a fully upright position.***

DO NOT use the convenience base when installing child restraint in aircraft.



Installing Carrier **WITHOUT** Convenience Base in Aircraft

1

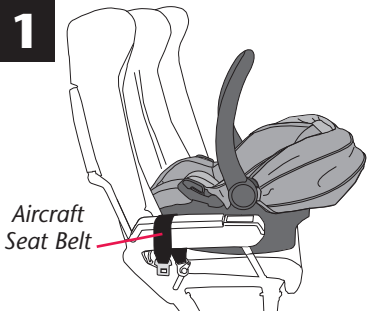

Aircraft
Seat Belt

Place the child restraint on the aircraft seat **rear-facing**, as shown above.

2

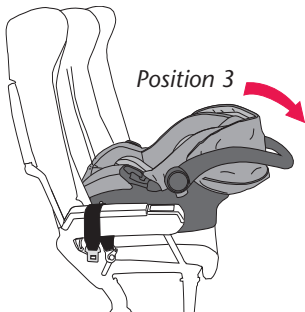

Position 3

Squeeze both handle releases and move the handle to *Position 3*.



3



Route the aircraft seat belt through the belt slots on the carrier, as shown above.



4

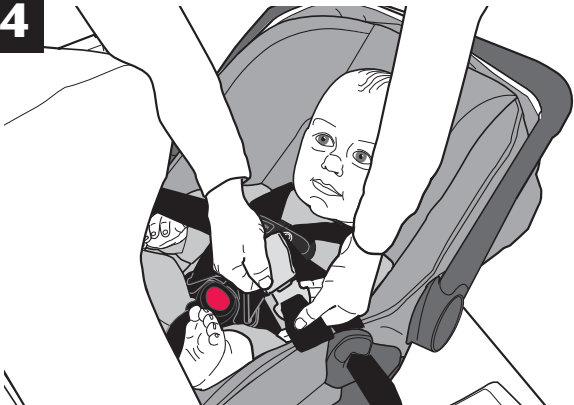

Fasten the aircraft seat belt.



Installing Carrier **WITHOUT** Convenience Base in Aircraft (cont.)

5

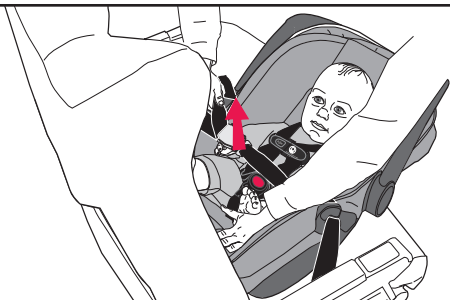

The aircraft seat belt must be as tight as possible. Route the excess seat belt strap back through the belt slots, as shown above. Using your full weight, push the child restraint firmly onto the aircraft seat while pulling on the excess seat belt strap to tighten.

Check your work. Try to move the child restraint in all directions. If you can move the child restraint more than 25 mm (1 in.) side-to-side or front to back at the belt path, the aircraft seat belt is not tight enough, and you **MUST** install again until the seat belt is tight.



6

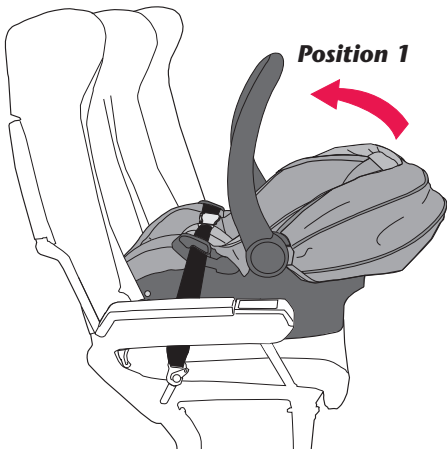

Squeeze both handle releases and move the handle to **Position 1**.

Installing the Canopy

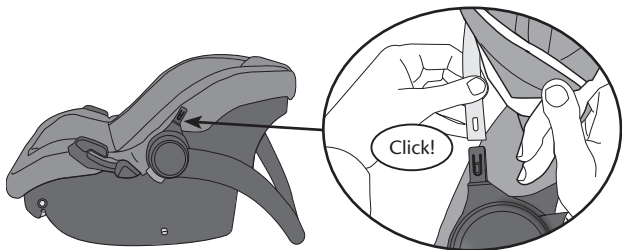

Insert front canopy end into the holder until it clicks into place. Repeat on the other side.

1

Not available on all models. Styles may vary.



The optional head pillow (p. 115) and/or body pillow is used to help support your child by placing it in the restraint, as shown.

IMPORTANT: *Support the child's head. Infants may have difficulty breathing when in a sitting position. Using additional padding or pillows behind the infant's head, or failure to properly recline the child restraint could increase the child's risk of serious injury or death.*

2



To remove the harness covers, follow steps for Changing the Harness Position (p. 79-82). After Step 3, slide harness covers off harness straps. Continue with Steps 4 through 6.

To reattach harness covers, follow steps for Changing the Harness Position (p. 79-82). After Step 3, slide harness covers onto harness straps. Continue with Steps 2 to 1.

IMPORTANT: *The shoulder harness straps should **ALWAYS** be as close as possible to, but **NEVER** above, the child's shoulders.*

3



To remove the buckle cover, press the red buckle release under the buckle cover, and remove buckle tongues. Pull buckle cover off the buckle.

To reattach the buckle cover press the red buckle release, and remove buckle tongues. Push the buckle cover onto the buckle.

IMPORTANT: The crotch strap should **ALWAYS** be as close as possible to, but **NEVER** under, the child's bottom. Adjust the crotch strap if necessary (p. 83).

Removing the Seat Pad

- Move handle to *Position 4* (p. 36).
- Unfasten chest clip and crotch buckle (p. 78).
- Remove crotch buckle cover (p. 109).
- Remove harness straps from splitter plate on back of child restraint (p. 81).
- Pull harness straps to front of child restraint (p. 80).
- Remove harness covers and body pillow (p. 108-107).

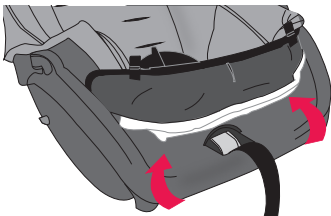

Remove two J-clips from front of child restraint and pull bottom of seat pad off front of child restraint.

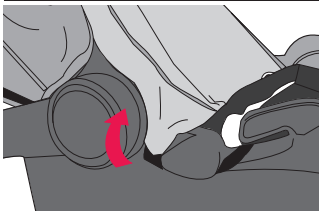

Remove J-clips from both sides of child restraint.



Removing the Seat Pad (cont.)

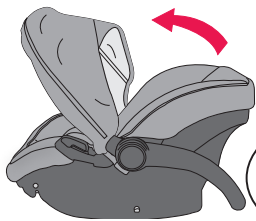

Unfasten Velcro® on back of canopy and pull canopy forward.

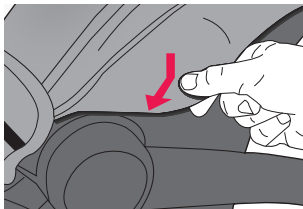

Slide I-clips down and out of slots on both sides of child restraint.

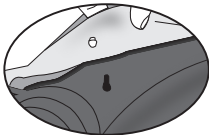

Removing the Seat Pad

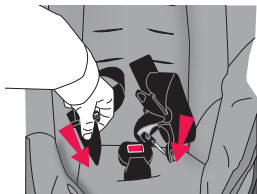

Push both harness straps through seat pad.

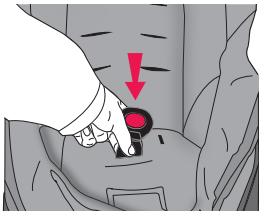

Push crotch buckle through seat pad.

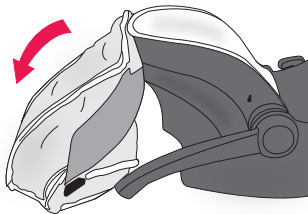

Push seat pad up and over child restraint.

Removing the Seat Pad (cont.)

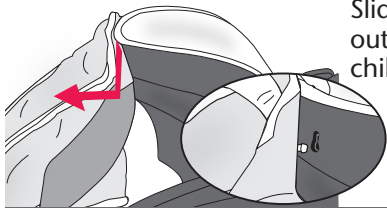

Slide I-clips down and out of slots on top of child restraint.

To replace seat pad, reverse these steps.

Note: Make sure to place harness strap in the same harness and waist slots as before. Make sure to place the crotch buckle in the same slot as before.

! WARNING! DEATH or SERIOUS INJURY can occur

Make sure both harness straps are installed **completely** on the splitter plate, as shown (p. 81). Failure to properly attach the harness straps to the splitter plate may result in a loose harness and serious injury or death to your child.

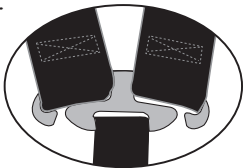

Replacement Parts

Not available on all models. Styles may vary.

To order replacement parts you can order online at www.evenflo.com or contact Evenflo. When you contact us, please have the product model number and date of manufacture (found on the back of the child restraint).



Buckle Cover



Head Foam
(Canada only)



EPS Foam



Harness Cover



Chest Clip

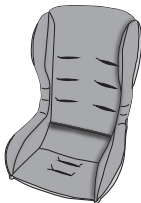

Body Pillow

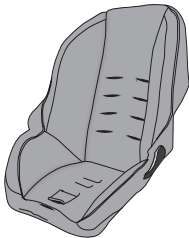

Seat pad

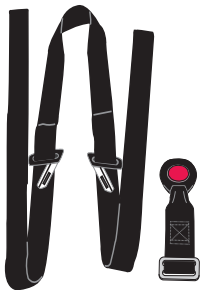

Harness System



Head Pillow



Canopy

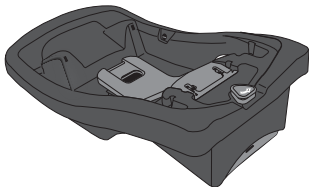

Accessory Base

Care and Cleaning

- **DO NOT** lubricate or immerse in water the LATCH connectors, the buckle, or any other part of this child restraint, unless rinsing is permitted, as stated on the back of the buckle for your restraint.
- Plastic and metal parts may be wiped clean with mild soap and water and dried with a soft cloth. Do not use abrasive cleaners or solvents.
- Take care not to damage any labels.
- The harness can be wiped clean with mild soap and water. Allow harness to air dry.
- Machine wash the seat pad separately in cold water, delicate cycle. Tumble dry 10 to 15 minutes on low heat.
- **NEVER** use child restraint without the seat pad.
- To protect the child restraint from damage caused by weather, rodents, and other elements common to garages, the outdoors, and other storage locations, remove the seat pad and thoroughly clean the restraint and pad prior to storage. Take care to clean in the areas where crumbs and other debris tend to accumulate.

TIP!

To help protect the vehicle upholstery, place a towel beneath and behind the child restraint.

Proper Disposal of this Child Restraint

When this child restraint reaches the expiration date found on the date of manufacture label, Evenflo encourages you to dispose of it properly. Most components of this child restraint are recyclable.

1. Remove all fabric and padding.
2. Remove all screws and disassemble the restraint.
3. Recycle all fabric, padding, plastic, foam and metal parts, if accepted by your local recycling center. Responsibly discard the rest.

If your local recycling center won't accept the padding, you may dispose of it in the landfill.

To prevent injury due to hidden damage, lost instructions, outdated technology, etc., discontinue use of this restraint after the expiration date on the label or if it has been involved in a crash.

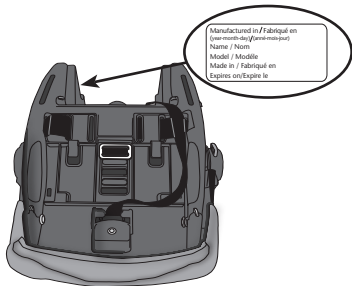

Limited Warranty

For a period of 90 days from the original purchase of this Product, Evenflo warrants to the original end user (“Purchaser”) this Product (including any accessories) against defects in material or workmanship. Evenflo’s sole obligation under this express limited warranty shall be, at Evenflo’s option, to repair or replace any Product that is determined to be defective by Evenflo and determined to be covered by this warranty.

Repair or replacement as provided under this warranty is the exclusive remedy of the Purchaser. Proof of purchase in the form of a receipted invoice or bill of sale evidencing that the Product is within the warranty period must be presented to obtain warranty service. This express limited warranty is extended by Evenflo ONLY to the original Purchaser of the Product and is not assignable or transferable to subsequent purchasers or end users of the Product. For warranty service, contact Evenflo’s ParentLink Consumer Resource Center.

EXCEPT TO THE EXTENT PROHIBITED BY APPLICABLE LAW, ANY IMPLIED WARRANTY OF MERCHANTABILITY OR FITNESS FOR A PARTICULAR PURPOSE ON THIS PRODUCT IS HEREBY DISCLAIMED. EVENFLO SHALL NOT BE LIABLE FOR ANY INCIDENTAL, CONSEQUENTIAL, SPECIAL OR PUNITIVE DAMAGES OF ANY KIND FOR BREACH OF THE EXPRESS LIMITED WARRANTY ON THIS PRODUCT, OR ANY WARRANTY IMPLIED BY OPERATION OF LAW. OTHER THAN THE EXPRESS LIMITED WARRANTY SET FORTH ABOVE, THERE ARE NO OTHER WARRANTIES THAT ACCOMPANY THIS PRODUCT AND ANY ORAL, WRITTEN OR ANY OTHER EXPRESS REPRESENTATION OF ANY KIND IS HEREBY DISCLAIMED.

ParentLink®

answers. advice. affirmation.

www.eventflo.com

USA: 1-800-233-5921, 8 AM – 5 PM E.T.

Canada: 1-937-773-3971

México: 01-800-706-12-00

Storing Your Instructions

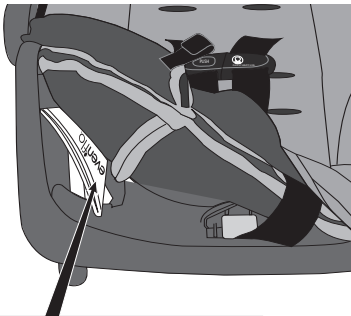

After thoroughly reading and following these instructions, store instructions under the seat pad on the inside of shell as shown

For future reference, record the model number of your child restraint AND the date of manufacture below.

Model Number: _____

Date of Manufacture: _____