

# ASSEMBLY INSTRUCTION

## BOOKCASE WITH CLEAR TEMPERED GLASS SHELVES

**A** Left Frame

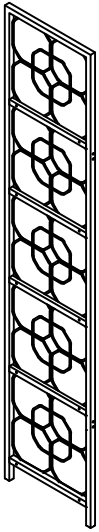

1pc

**B** Right Frame

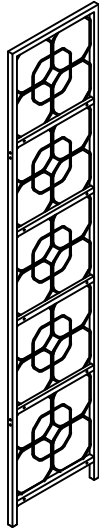

1pc

**C** Shelf Frame

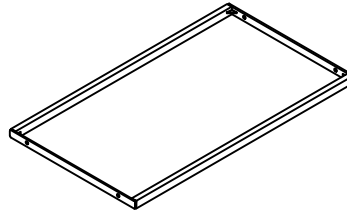

3pcs

**D** Shelf Frame

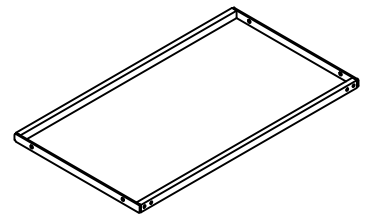

2pcs

**E** Top Frame

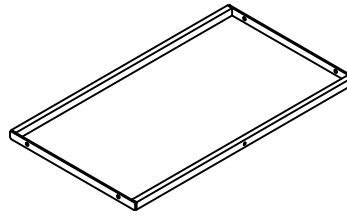

1pc

**F** Shelf Board

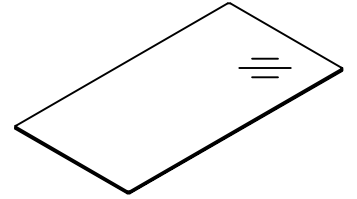

6pcs

**G** Metal Sheet

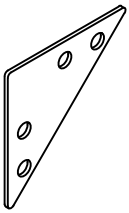

4pcs

**H** Bolt  
Ø3/16"x1/2"

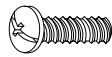

16pcs

**I** Bolt  
Ø1/4"x1/2"

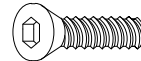

24pcs

**J** Glass Pad  
Ø12x2mm



24pcs

**K** Allen Key  
M4



1pc

**L** Anti-Tipping Kit

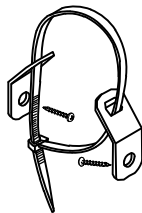

1set

**M** Screwdriver  
(Not Provided)

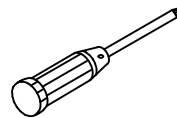

1pc

**N** Flat Washer  
Ø12mm



16pcs

**O** Leveler  
Ø1/4"x16mm



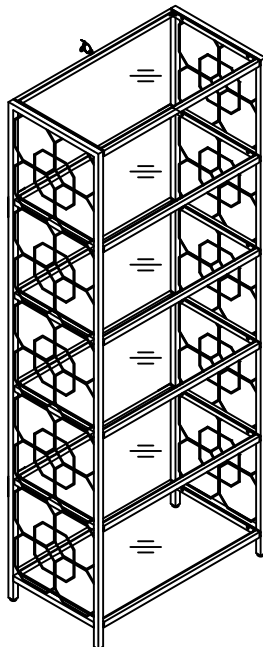

4pcs



This page lists all the contents included in the box. Please take the time to identify the hardware as well as the individual components to this product. As you unpack and prepare for assembly, place the contents on a carpeted or padded area to protect them from damage.

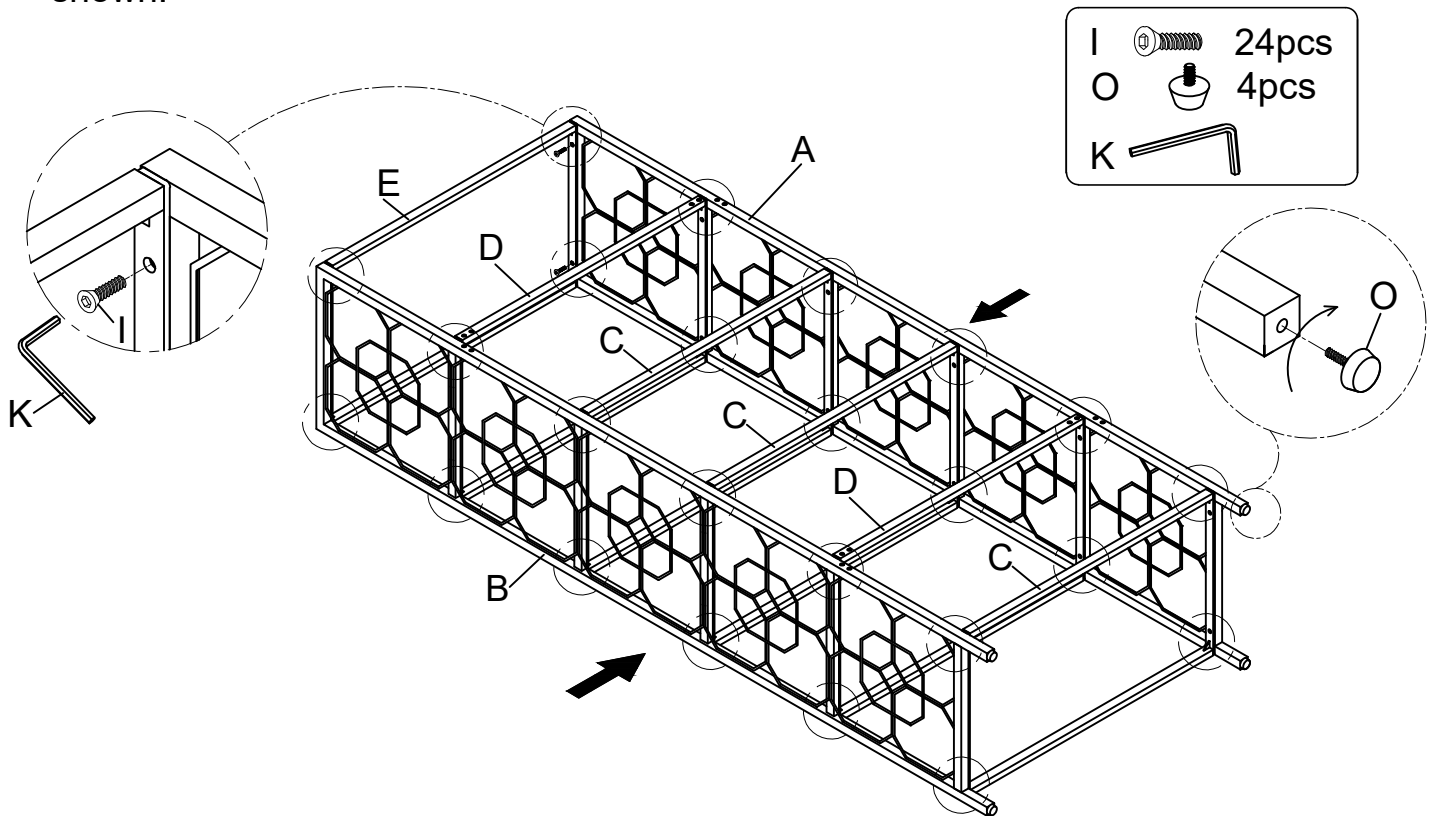

**1** Assemble Left Frame (A) and Right Frame (B) to Shelf Frame (C), Shelf Frame (D) and Top frame (E), using Bolt (I) to fasten by Allen Key (K). Assemble Leveler (O) to bottom of Left Frame (A) & Right Frame (B) as below shown.

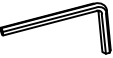

- I  24pcs
- O  4pcs
- K 

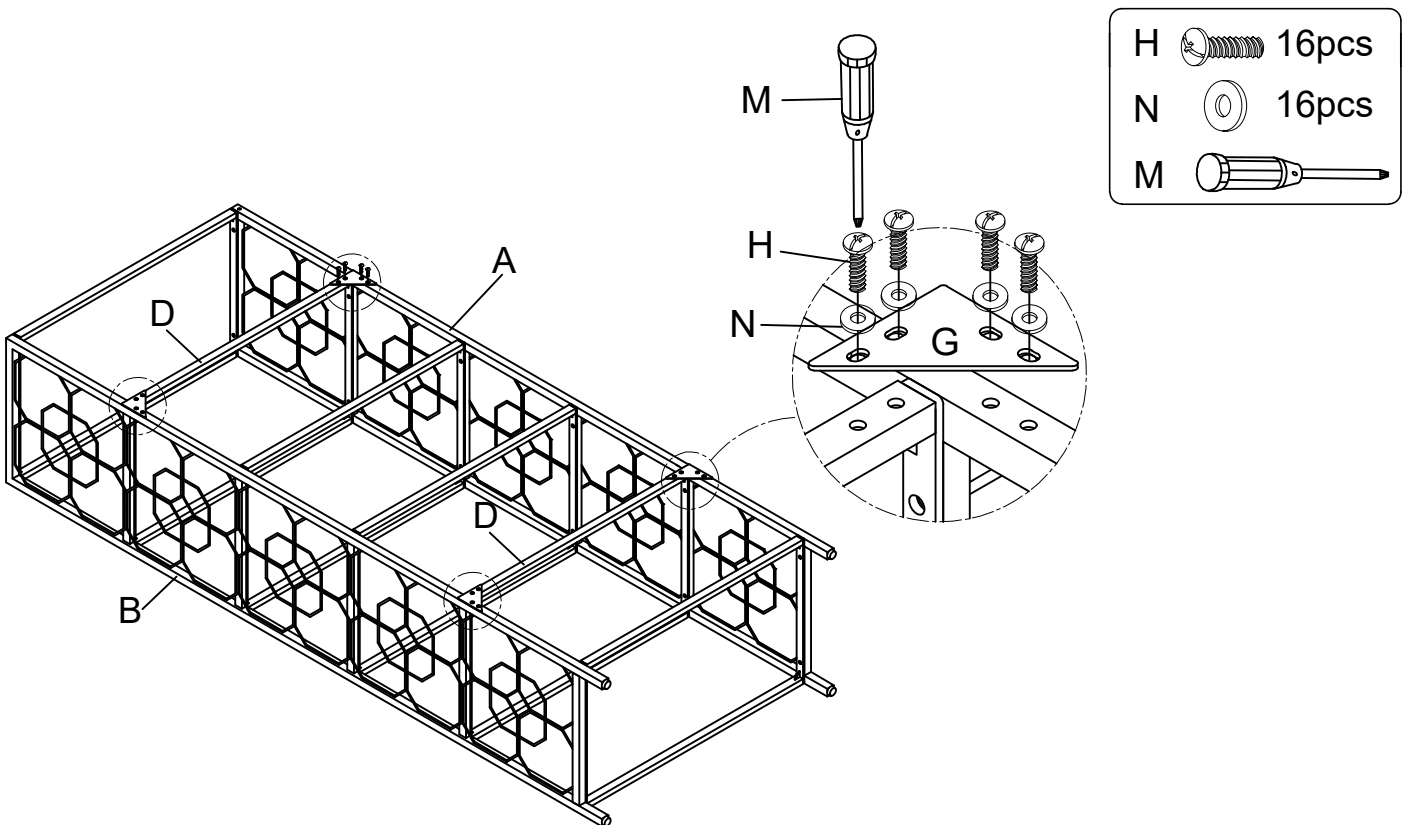
**2** Assemble Metal Sheet (G) to the back of Left Frame (A) and Right Frame (B) with the second & fifth Shelf Frame (D), using Bolt (H) & Flat Washer (N) to fasten by Screwdriver (M).

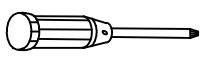

- H  16pcs
- N  16pcs
- M 

**3** Assemble Glass Pad (J) to all Shelf Frame (C), Shelf Frame(D) and Top Frame (E) as below shown.

J  24pcs

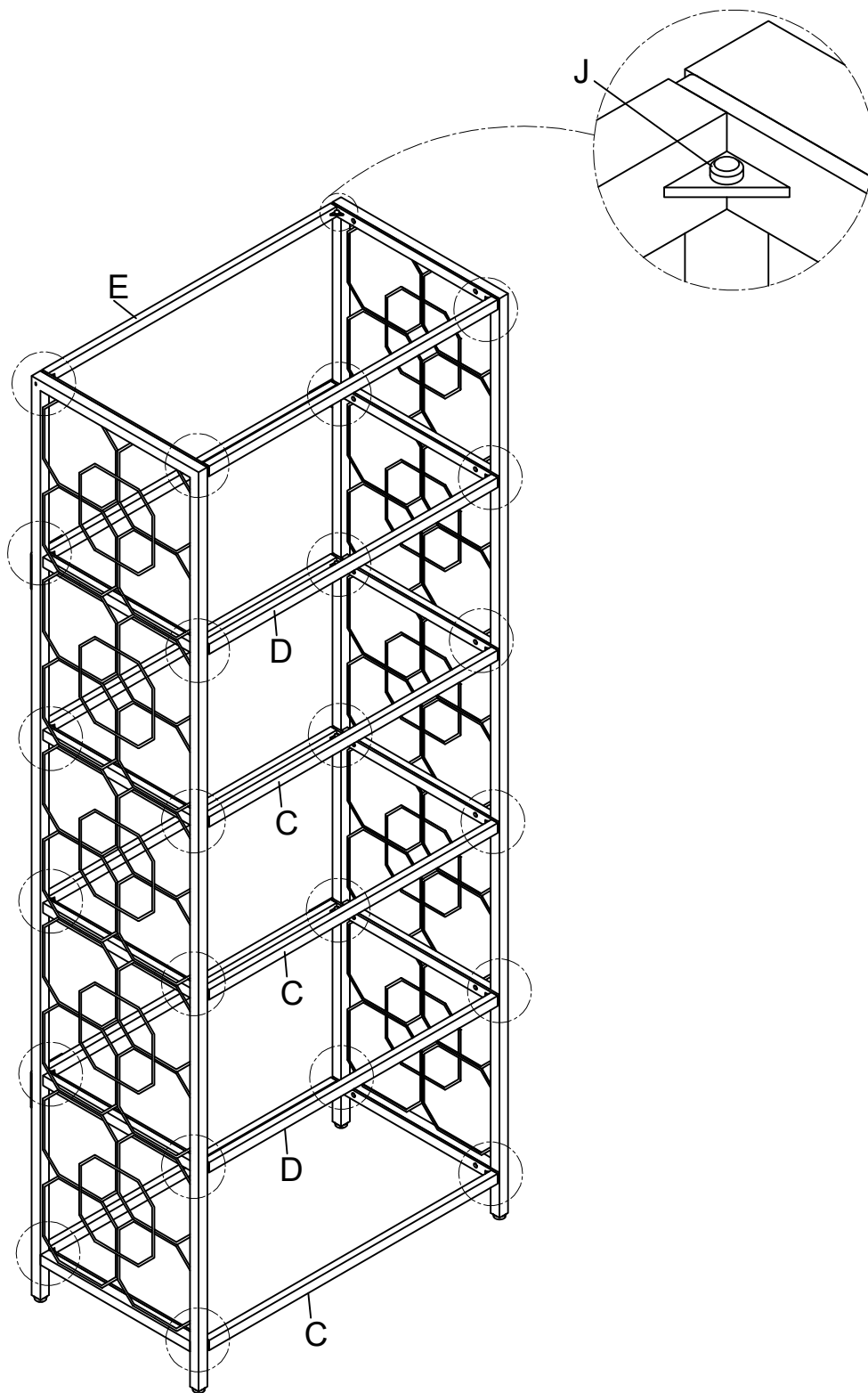

**4** Put all Shelf Board (F) to the Glass Pad (J) on Shelf Frame (C), Shelf Frame(D) and Top Frame (E) as below shown.

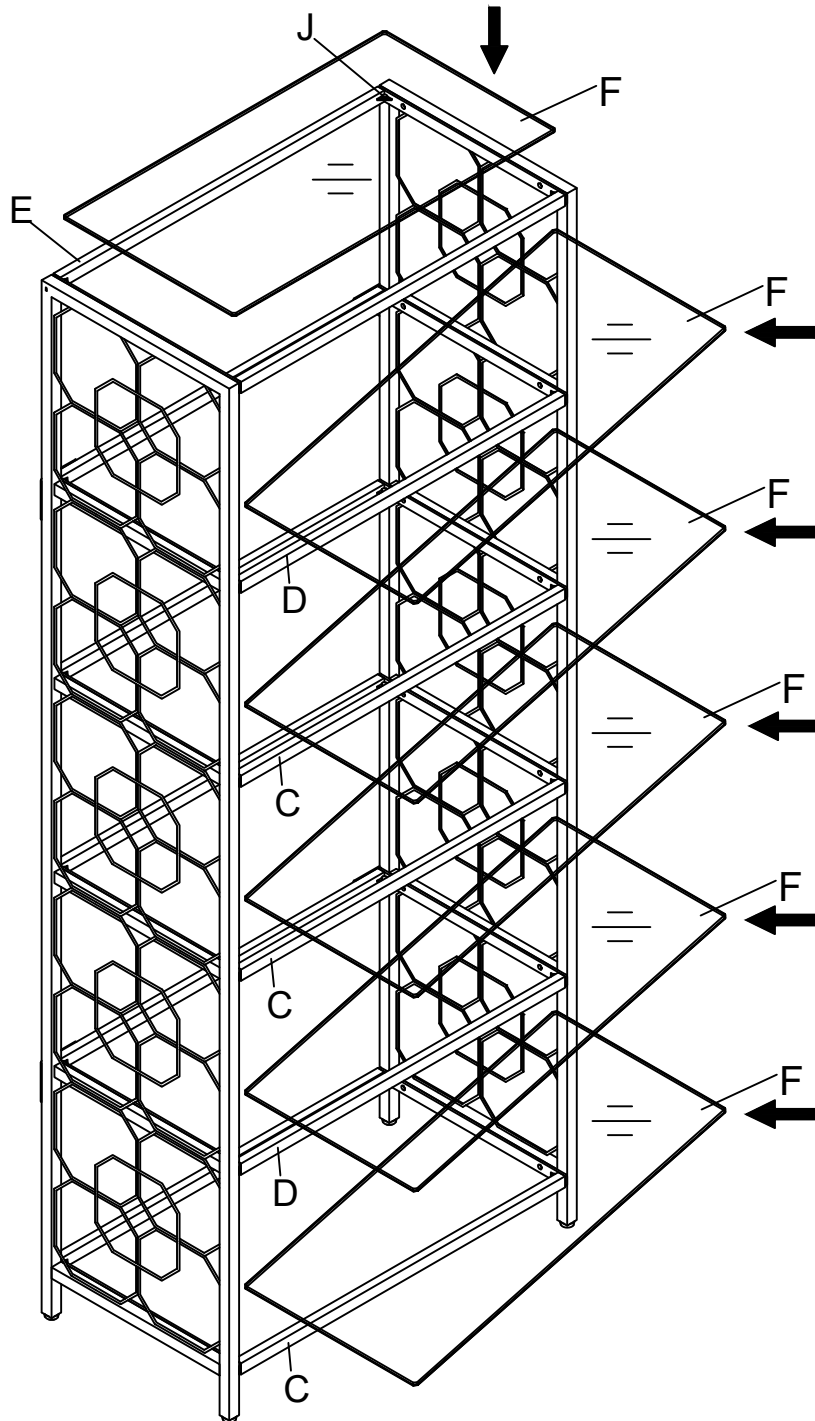

- 5** Remark: there is a tip restraint kit provided on the back of this product. Please read the instruction thoroughly and install immediately when placed in home. To prevent tip over, the product must be attached to wall.

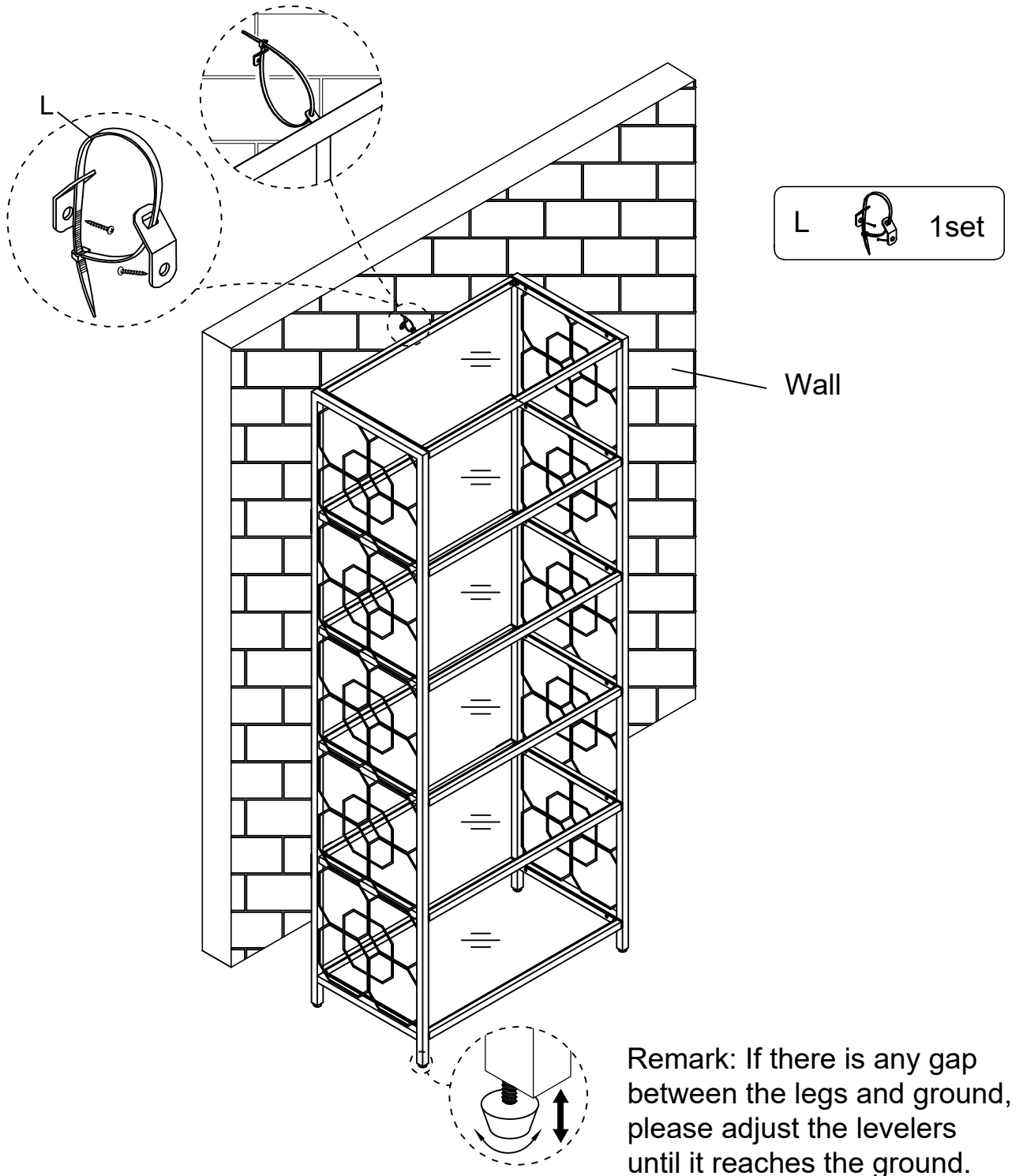

Adjust any parts out of alignment and tighten all bolts and screws from steps 1 through 5.

### Cleaning & Care

Treat surface with care. Surface is resistant to scratches but is not scratch resistant. Clean surfaces with a dry or damp soft cloth. Do not use abrasive cleaners. Hardware may loosen over time. Periodically check that all connections are tight.