

Ice Maker

User Manual
HI8LMK

www.HaierAmerica.com

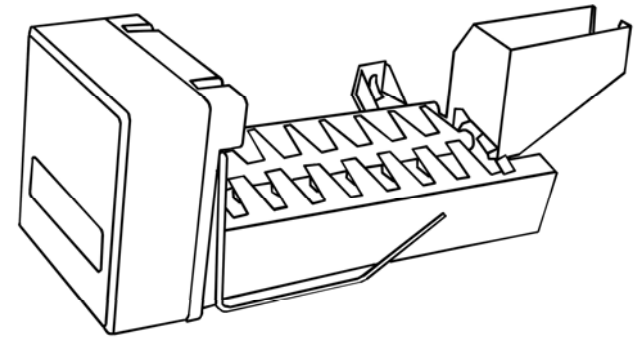

Model # HI8LMK
Issue Date: September 2014
120 V, 60 Hz

Made in China

Haier America
New York, NY 10018
©2014 Haier America Trading, LLC.

Haier

SMARTER LIFE BETTER PLANET

P/N 0060519193 Rev A

TABLE OF CONTENTS

SAFETY INFORMATION

Important Safety Instructions.....3

SET UP & USE

Supplies Required for Installation.....4

Tools Required for Installation..... 4

Parts Included..... 4

Installation Instructions.....5-8

Water Supply Connection..... 9

Ice Maker Operation.....10

Tips & Care.....10

Normal Operating Sounds.....10

TROUBLESHOOTING & WARRANTY

Ice Maker Fill Adjustment.....11

Customer Service.....11

Troubleshooting.....12

Limited Warranty.....13

PRODUCT REGISTRATION

Thank you for purchasing our Haier product. This easy-to-use manual will guide you in getting the best use of your product.

_____ **Model Number**

Remember to record the model and serial numbers. They are located on a label on the ice maker.

_____ **Date of Purchase**

Staple your receipt to your manual. You will need it to obtain warranty service.

IMPORTANT SAFETY INSTRUCTIONS



WARNING

TO AVOID ELECTRICAL SHOCK, WHICH CAN CAUSE DEATH OR SEVERE PERSONAL INJURY, DISCONNECT THE POWER SUPPLY BEFORE CONNECTING A WATER SUPPLY LINE TO THE REFRIGERATOR.



WARNING

DO NOT PLACE FINGERS OR HAND ON THE AUTOMATIC ICE MAKING MECHANISM WHILE THE REFRIGERATOR IS PLUGGED IN. THIS WILL HELP PROTECT YOU FROM POSSIBLE INJURY AS WELL AS PREVENT INTERFERENCE WITH MOVING PARTS OF THE EJECTOR MECHANISM AND THE HEATING ELEMENT THAT RELEASES THE CUBES.

PROFESSIONAL INSTALLATION IS RECOMMENDED.

TO AVOID PROPERTY DAMAGE:

- Copper tubing is recommended for the water supply line. Water supply tubing should be 1/4". Plastic is not recommended since it greatly increases the potential for water leaks.
- Do not install water supply tubing in areas where the temperature falls below freezing.
- Connect the ice maker to a drinkable water source that is not connected to a water softening system. Chemicals from the softener may damage the ice maker, causing it to malfunction.

SAVE THESE INSTRUCTIONS
HOUSEHOLD USE ONLY

SUPPLIES REQUIRED FOR INSTALLATION

The following items are required to install the ice maker.

- ¼-inch copper supply line with shut off valve.
- ¼-inch brass compression nut and ferrule (sleeve).

NOTE: The copper tubing and shut-off valve should be available at your local hardware or plumbing supply store. Coil enough tubing in the back of the unit to allow movement of the refrigerator for cleaning and service.

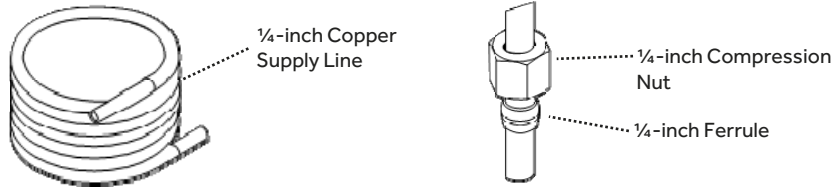

TOOLS REQUIRED FOR INSTALLATION

- 1/4-inch socket wrench or nut driver
- Phillips & Flathead screwdriver
- Adjustable wrench
- Pliers

PARTS INCLUDED

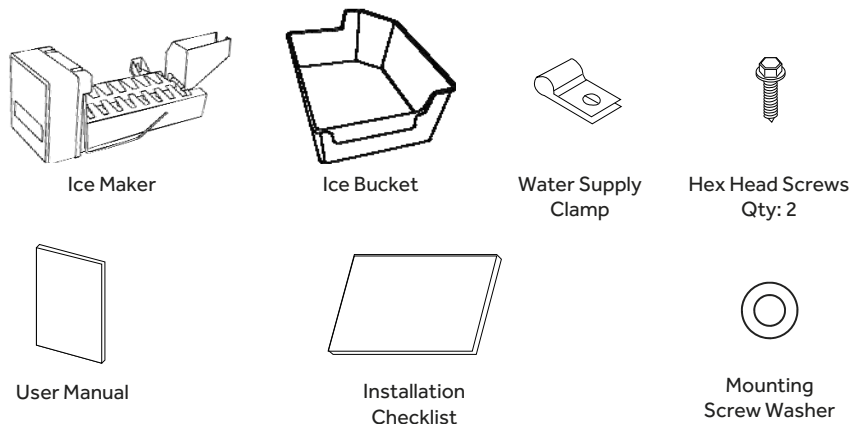

LIMITED WARRANTY

In-Home Service - What is covered and for how long?

This warranty covers all defects in workmanship or materials of the automatic ice maker for a period of:

12 months labor

12 months parts

The warranty commences on the date the item was purchased and the original purchase receipt must be presented to the authorized service center before warranty repairs are rendered.

What is covered?

1. The mechanical and electrical parts, which serve as a functional, purpose of this kit for a period of 12 months.

What will be done?

1. We will repair or replace, at our discretion any mechanical or electrical part which proves to be defective in normal usage during the warranty period so specified.
2. There will be no charge to the purchaser for parts and labor on any covered items during the initial 12 month period.
3. Contact your nearest authorized service center. For the name of the nearest service center please call 1-877-337-3639

THIS WARRANTY COVERS WITHIN THE CONTINENTAL UNITED STATES, PUERTO RICO AND CANADA. IT DOES NOT COVER THE FOLLOWING:

- Damages from improper installation.
- Damages occurred during shipping.
- Damage from end user's misuse, abuse, accident, alteration, lack of proper care and maintenance or incorrect current or voltage.
- Damage from non-household use.
- Damage from service by other than an authorized dealer or service center.
- Improper installation. If you have an installation problem, contact your dealer or installer. You will be responsible for providing adequate electrical, plumbing and other connecting facilities, including the water line to the ice maker and the water line installation.
- Replacement of house fuses or resetting of circuit breakers.
- Failure of the product if it is used for other than its intended purpose or used commercially.
- Damage to product caused by inevitable accidents, natural disasters such as fire, floods or other Acts of God.

WARRANTOR IS NOT RESPONSIBLE FOR CONSEQUENTIAL DAMAGES. THIS LIMITED WARRANTY IS GIVEN IN LIEU OF ALL OTHER WARRANTIES, EXPRESSED OR, INCLUDING THE WARRANTIES OF MERCHANTABILITY AND FITNESS FOR A PARTICULAR PURPOSE.

The remedy provided in this warranty is exclusive and is granted in lieu of all other remedies. This warranty does not cover incidental or consequential damages, so the above limitations may not apply to you. Some States do not allow limitations on how long an implied warranty lasts, so the above limitations may not apply to you. This warranty gives you specific legal rights, and you may have other rights, which vary, from state to state.

Haier America
New York, NY 10018

TROUBLESHOOTING

PROBLEM	CAUSE/SOLUTION
No ice produced	Ensure that refrigerator is plugged in to power source
	Wire control arm is fully raised. See Page 7.
	Check that ice maker is plugged into electrical socket in rear of freezer compartment. See Pages 5-6.
	Water supply is turned off or disconnected.
	Disconnect refrigerator from power source, remove rear access cover, then check to see that water valve is plugged into wiring harness in rear bottom compartment.
Low/slow ice production	Adjust freezer temperature to colder setting. See Refrigerator User Manual for instructions.
	Check for leaks or kinks in water tubing on rear of refrigerator.
Water leak in freezer	Check that fill tube is aligned into fill cup on rear of ice maker. See Page 6.
Water leak under refrigerator	Check for leaks in water tubing on rear of refrigerator.
	Disconnect refrigerator for power supply, remove rear compartment cover, then check water connections on water valve.

INSTALLATION INSTRUCTIONS

1. Move refrigerator away from wall and unplug.
2. Remove freezer shelf by lifting up and sliding it out of freezer compartment.

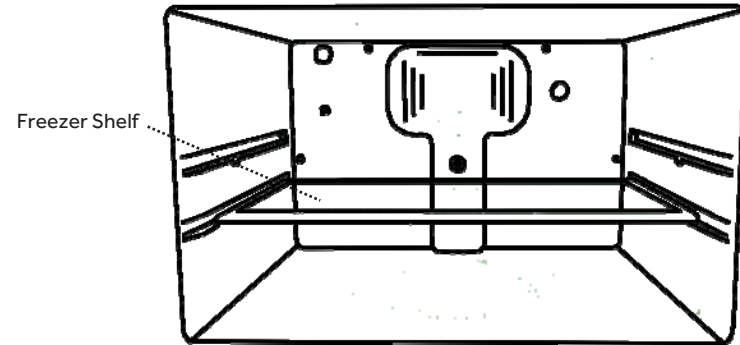

3. Remove plastic plug above electrical socket by grasping firmly and pulling end of plug down.

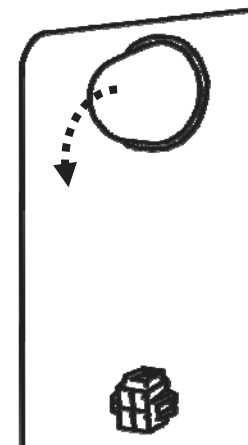

4. Remove electrical socket cover by gently prying the top snap loose with a flathead screwdriver. Be careful not to scratch the rear compartment cover.

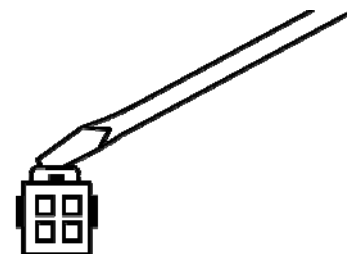

INSTALLATION INSTRUCTIONS CONT.

5. Position ice maker harness in ice maker hook as shown below:

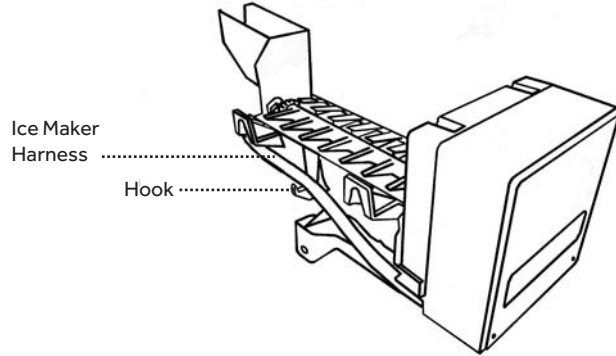

6. Insert ice maker electrical plug into socket on rear wall of freezer.

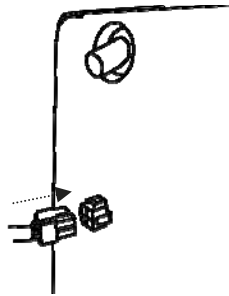

7. Position fill tube into slot in rear of ice maker fill cup.

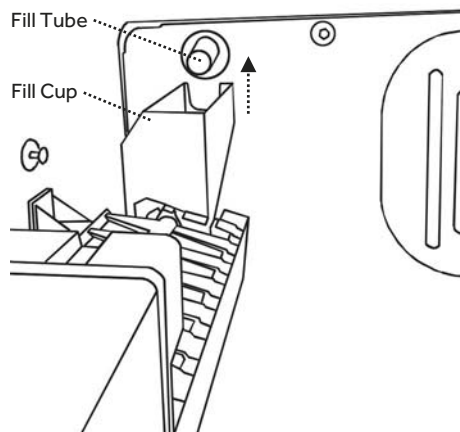

ICE MAKER FILL ADJUSTMENT

THESE INSTRUCTIONS SHOULD ONLY BE USED IF THE HOME HAS UNUSUALLY LOW WATER PRESSURE THAT RESULTS IN LOW ICE PRODUCTION OR SMALL ICE CUBE SIZE. CHANGES TO HOME PLUMBING COULD AFFECT ICE MAKER FILL AMOUNT AND RESULT IN OVERFLOWED WATER IN THE FREEZER COMPARTMENT.

If your ice maker is making small ice cubes or isn't producing a satisfactory amount of ice, it is possible to improve this by adjusting the amount of water used to fill the ice cube tray in the ice maker.

NOTE: Increasing the water fill amount could cause water to overflow the ice maker. Make half-turn adjustments until ice cube size or ice production amount is satisfactory. Allow 24 hours between adjustments. Closely monitor the freezer compartment for water overflow after fill adjustment.

1. Use flathead screwdriver to pry front cover of ice maker. Do not discard front cover.

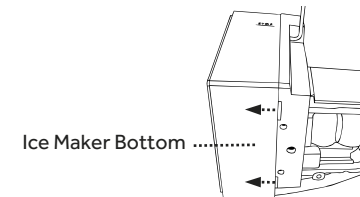

2. Use a Phillips screwdriver to turn fill adjustment screw clockwise to DECREASE water fill amount. Turn screw counter-clockwise to INCREASE water fill amount.

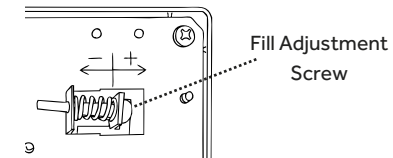

3. Replace front cover of ice maker.

CUSTOMER SERVICE

IMPORTANT

DO NOT RETURN THIS PRODUCT TO THE STORE

If you have a problem with this product, please contact the Haier Customer Satisfaction Center at 1-877-337-3639

DATED PROOF OF PURCHASE, MODEL NUMBER AND SERIAL NUMBER REQUIRED FOR WARRANTY SERVICE

CUSTOMER SERVICE

SERVICIO AL CLIENTE

Hotline
1-877-337-3639

ICE MAKER OPERATION

NOTE: It takes approximately 24 hours for the ice maker to produce ice. New plumbing may cause ice discoloration and poor flavor. Discard ice made in the first 24 hours.

To stop the ice maker, lift the wire arm until it clicks and locks in the OFF (raised) position. The ice maker turns OFF automatically when the ice container is full.

TIPS & CARE

- Water quality determines ice quality. Do not connect the ice maker to water that is softened. Chemicals from a malfunctioning softener can damage the ice maker.
- Ice stored too long may develop an odd flavor. Empty the container and make sure the wire arm is in the ON (lowered) position. The ice maker will then produce ice.
- Keep the wire arm in OFF position until the refrigerator is connected to the water supply or whenever the water supply is turned OFF.

CAUTION:

- Do not wash the ice bucket in your dishwasher.
- Be sure to stop the ice maker when cleaning the freezer or on vacation.
- If the ice maker has to be turned OFF for a long period of time, turn the water supply valve to the closed position.
- Do not store anything on top of or in the ice maker or the ice bucket.

NORMAL OPERATING SOUNDS

The following sounds are normal when the ice maker is operating:

- Motor running (inside freezer compartment)
- Ice dropping into ice bucket (inside freezer compartment)
- Running water (inside freezer compartment)
- Water valve opening or closing (clicking from rear of refrigerator)

INSTALLATION INSTRUCTIONS CONT.

8. Hang ice maker from mounting posts.

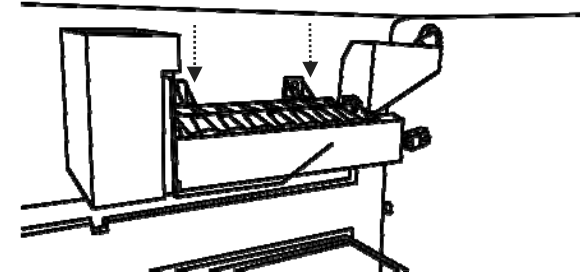

9. Use hex head screw and washer to secure tab on bottom of ice maker to inside of freezer.

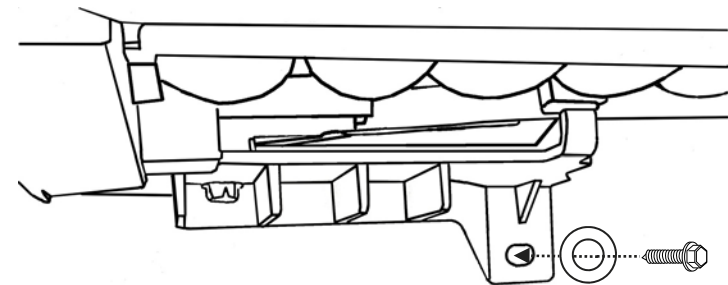

10. Re-install freezer shelf on lowest rail as shown and place ice bucket under the ice maker. Raise wire control arm on ice maker to OFF position.

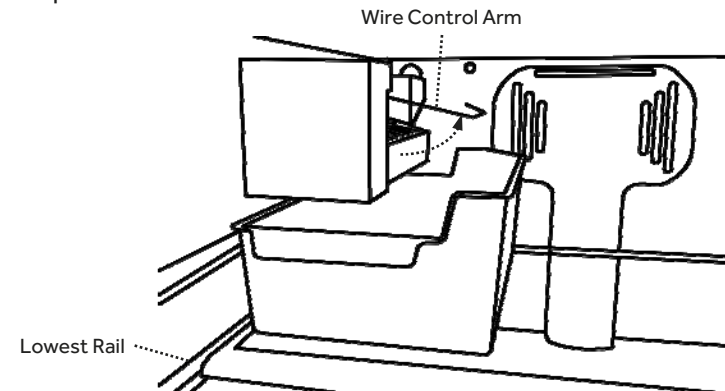

INSTALLATION INSTRUCTIONS CONT.

11. Locate water valve on rear of refrigerator. Valve protrudes slightly through rear compartment cover.

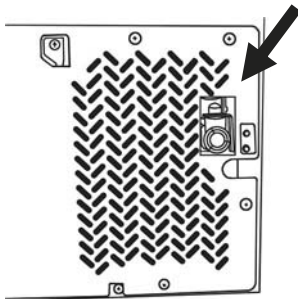

12. Insert supply line fully into water valve inlet. Slide ferrule (sleeve) into valve inlet and tighten compression nut onto valve with wrench. **Do not over-tighten.**

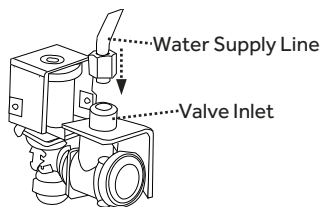

WATER SUPPLY CONNECTION



WARNING

THIS WATER SUPPLY INSTALLATION IS NOT COVERED UNDER WARRANTY BY THE REFRIGERATOR OR ICE MAKER MANUFACTURER(S). FOLLOW THESE INSTRUCTIONS CAREFULLY TO MINIMIZE THE RISK OF EXPENSIVE WATER DAMAGE.

Supplies Required for Installation:

- Access to a household **cold water** line with water pressure between 20psi and 120psi.
- A water supply line made of 1/4-inch Outside Diameter, copper tubing. To determine the length of the copper tubing needed, you will need to measure the distance from the ice maker water valve at the back of the refrigerator to your cold water line. Then add approximately 7 feet for the refrigerator to be moved out for cleaning and service.
- A **shut-off valve** to connect the water supply line to your household water system.

NOTE: Do not use a self-piercing type shut-off valve.

- A compression nut and ferrule (sleeve) for connecting the water supply line to the ice maker inlet valve. See page 4 for picture.
1. Turn off water supply at shut-off valve.
 2. Connect copper water supply line to household water system.
 3. Turn ON water supply and tighten any connections that leak.
 4. Coil excess water supply line behind refrigerator, as shown below and arrange coils so they do not vibrate or wear against other surfaces. Use water supply clamp and hex head screw to secure water supply line to rear of refrigerator.

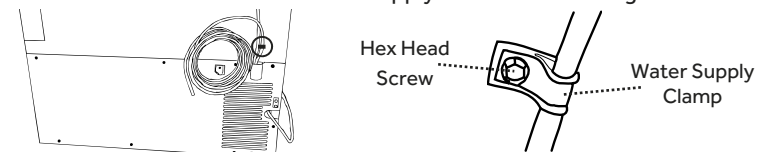

6. Reconnect refrigerator to power supply.
7. Move refrigerator back into place and level it using instructions in User Manual.
8. Turn ice maker ON by lowering wire control arm.

