

24" Grand Grab Bar with Contemporary Square/Diamond Round Flange

Model #: C17-24-

JACLO®

Confidence from start to finish.™



FEATURES:

- ADA compliant when properly installed
- Complements Cubix®, Astor & Westfield collections
- Covers standard 3" flange on existing stainless steel grab bars
- No need to re-tile in retro-fit applications
- Flange can be mounted in square or diamond position
- 1 1/4" diameter
- For large quantity custom lengths contact hospitality@jaclo.com

AVAILABLE FINISHES:

Polished Chrome (PCH)	Satin Chrome (SC)	Bronze Umber (BU)
Satin Nickel (SN)	Pewter (PEW)	Caramel Bronze (CB)
Polished Nickel (PN)	Antique Brass (AB)	Antique Copper (ACU)
Oil-Rubbed Bronze (ORB)	Polished Brass (PB)	Polished Copper (PCU)
Vintage Bronze (VB)	Satin Brass (SB)	Matte Black (MBK)
Satin Gold (SG)	Polished Gold (PG)	Black Nickel (BKN)
White (WH)	Unlacquered Brass (ULB)	Satin Cooper (SCU)
Almond (ALD)	Amber (AMB)	Azure Blue (AZB)
Coral (COR)	Mint Green (GRN)	Stone Grey (GRY)
Lilac (LAC)	Light Blue (LBL)	Limon (LIM)
Plum (PLM)	Pink (PNK)	Red (RED)
Graphite (GPH)	Aged Urban Brass (AUB)	

SPECIFICATION DRAWING:

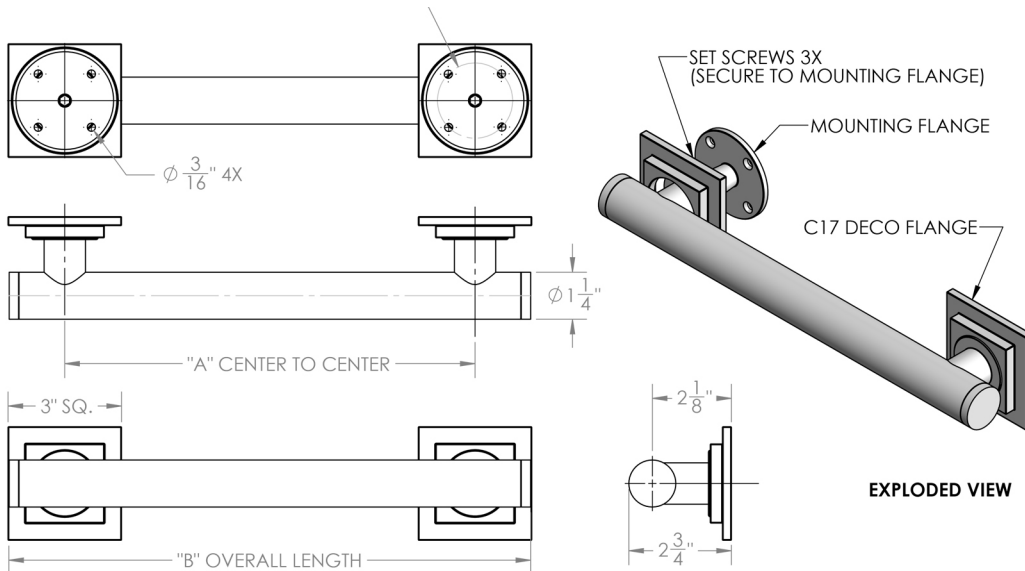

Part #	A	B
C17-12	12"	13 7/8"
C17-16	16"	17 7/8"
C17-18	18"	19 7/8"
C17-24	24"	25 7/8"
C17-32	32"	33 7/8"
C17-36	36"	37 7/8"