

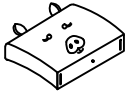

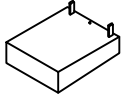





# ASSEMBLY INSTRUCTION

## PIG SLIPPER CHAIR

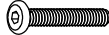
<b>A</b> Chair Back  1pc	<b>B</b> Chair Seat  1pc	<b>C</b> Front Leg (LSF)  1pc	<b>D</b> Front Leg (RSF)  1pc
<b>E</b> Back Leg (LSF)  1pc	<b>F</b> Back Leg (RSF)  1pc	<b>G</b> Allen Bolt $\text{\O}1/4\text{"}\times 55\text{mm}$  8pcs	<b>H</b> Allen Bolt $\text{\O}1/4\text{"}\times 32\text{mm}$  1pc
<b>I</b> Spring Washer $\text{\O}1/4\text{"}$  9pcs	<b>J</b> Flat Washer $\text{\O}1/4\text{"}\times 22\text{mm}$  9pcs	<b>K</b> Allen Key 4mm  1pc	

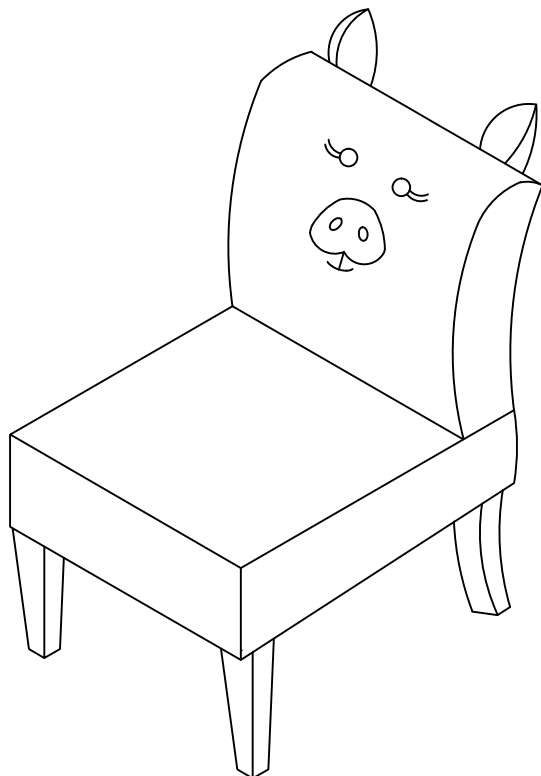

This page lists all the contents included in the box. Please take the time to identify the hardware as well as the individual components to this product. As you unpack and prepare for assembly, place the contents on a carpeted or padded area to protect them from damage.

### IMPORTANT NOTE:

1. Do not tighten all screws / bolts until all completely assembled.
2. Keep all hardware parts out of reach of children.

**1** Attach Chair Back (A) to the Chair Seat (B).

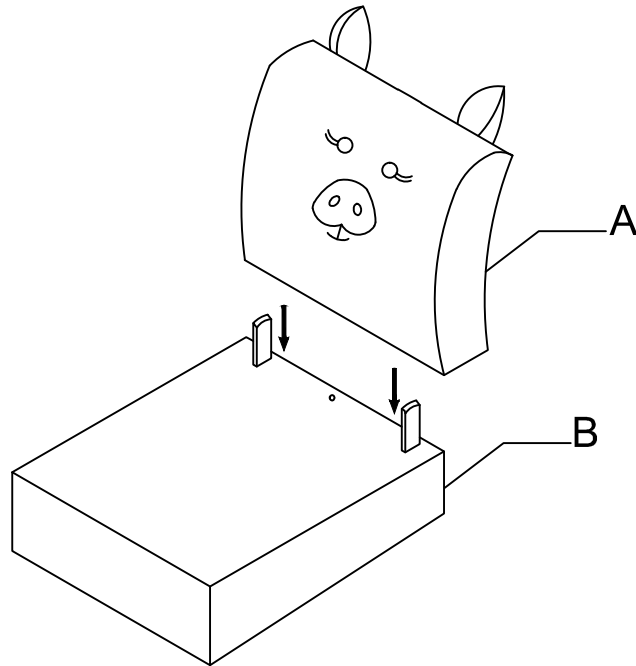

**2** Tighten the Chair Seat (B) with Chair Back (A) using Allen Bolt (H), Spring Washer (I), Flat Washer (J) with Allen Key (K). Attach Front Leg (C & D) and Back Leg (E & F) to Chair Seat (B) using Allen Bolt (G), Spring Washer (I), Flat Washer (J) with Allen Key (K).

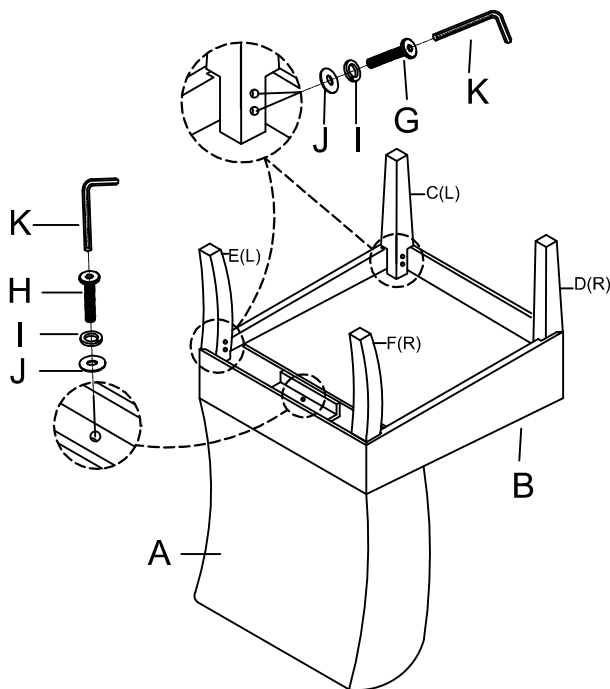

Take the Allen Key, and turn the bolts until the legs are secured.  
**DO NOT TIGHTEN COMPLETELY.**  
Stop when you feel you are adding force to tighten the bolt.

---

### 3 Stick the Black Nonwoven Fabric to the bottom of the Chair Seat (B).

Stand chair up on an even surface and check that it is balanced.

If there is a slight wobble, apply downward pressure in the corner where a leg is uneven. Keeping pressure in that corner, tighten all bolts.

If balanced, apply downward pressure evenly in the center and tighten all bolts. Do not over-tighten beyond hole depth.

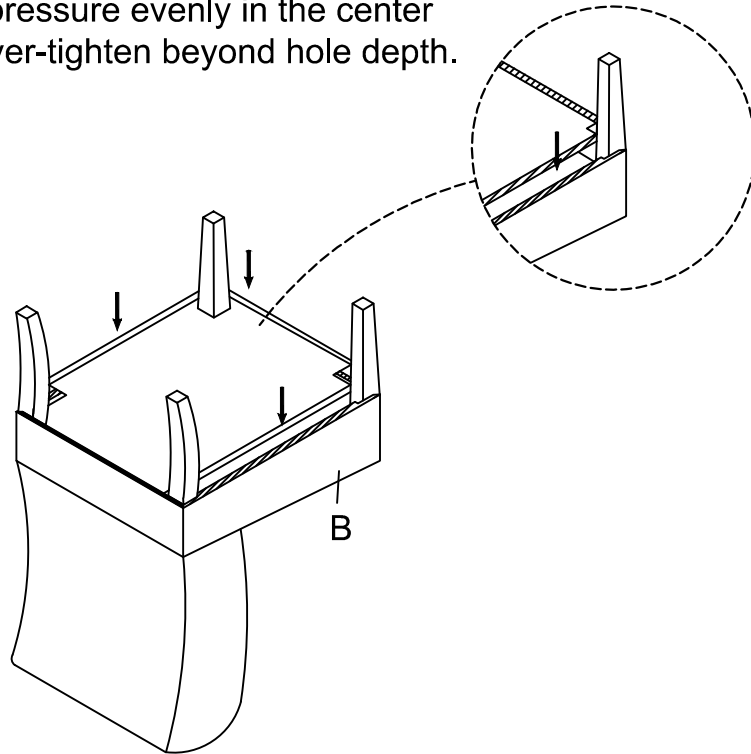

#### Helpful Tip:

- Instead of applying downward pressure while reaching under to tighten bolts, have someone sit in the chair while you tighten the bolts.

---

#### Cleaning & Care

Treat surface with care. Surface is resistant to scratches but is not scratch resistant. Clean surfaces with a dry or damp soft cloth. Do not use abrasive cleaners. Hardware may loosen over time. Periodically check that all connections are tight.