



**Send Us a Text:** 1-812-652-2525  
(US and Canada Only.  
Carrier Fees May Apply)



**Find Us Online:** [www.safety1st.com](http://www.safety1st.com)  
**Email Us:** [support@djgusa.com](mailto:support@djgusa.com)



**Give Us a Call:** 1-800-544-1108  
(Toll Free, US and Canada Only)

## Replacement Parts List

(on select models)

- Buckle Assembly
- Non-Magnetic Chest Clip
- SecureTech™ Magnetic Chest Clip
- Seat Pad Set
- Removable Cup Holder(s)
- Cup Holder Snack Lid
- Shoulder Belt-Positioning Clip
- Top Tether
- Locking Clip
- Instructions

**For parts availability and questions, call, text, or chat.**

**If requested color is not available, similar color  
will be substituted.**

**Applicable tax and shipping & handling  
will also be added.**



# Safety 1<sup>ST</sup>

## SlimRide EverSlim

All-in-One  
Convertible  
Car Seat



Your model may look different than one shown on cover.

**KEEP INSTRUCTIONS FOR FUTURE USE.**

**Read all instructions before  
using this car seat.**

**WARNING**  Failure to follow the warnings on the labels and in the instruction manual can result in serious injury or death to your child.



4358-8302A

11.30.22

## Welcome to the Safety 1st Family!

Thank you for choosing this car seat, also known as a child restraint!

To help you get started using your child's new car seat, here are the 4 main tasks you'll need to complete.

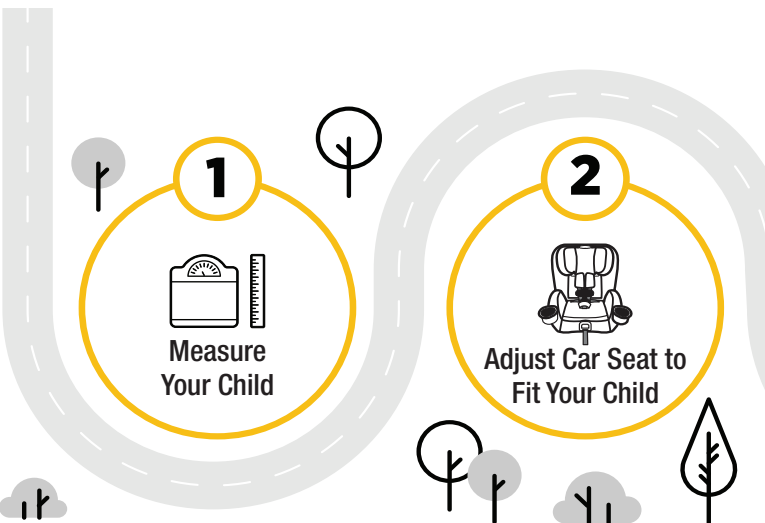

Your child's safety is worth the time it will take to read and follow these instructions.

Ready? Let's go!

**Pages 1-4** will introduce you to the parts of the car seat.

**The Back Cover of this Manual** has our contact information.

If at any point you would like assistance, please feel free to reach out to us.



**3**



**Install Car Seat into  
Your Vehicle**



**4**



**Secure Your Child  
in Car Seat**



©2022 Dorel Juvenile Group, Inc. Safety 1st™ and the Safety 1st logo and design are trademarks of Dorel Juvenile Group, Inc. (800) 544-1108 [www.safety1st.com](http://www.safety1st.com). Styles and colors may vary. Los estilos y los colores pueden variar. Made in CHINA. Hecho en CHINA. Distributed by (distribuido por) Dorel Juvenile Group, Inc., 2525 State St., Columbus, IN 47201-7494. Dorel Juvenile Canada, 2233 Argentia Road, Suite 110, Mississauga, ON L5N 2X7. Importado y Distribuido en Chile por: Comercial e Industrial Silfa S.A. - San Ignacio 0201 / Parque Industrial Portezuelo Quilicura, Santiago Chile. Fono (562) 2339 9000. En Perú por: Comexa S.A. - Los Libertadores 455 - San Isidro, Lima - Perú. Fono (511) 4469014. En Centro América, Caribe y Ecuador por: Best Brands Group S.A. - Av. Balboa, Bay Mall Plaza, Planta Baja, local 9, Panamá. - Fono: (507) 300 2884. En Colombia por: Baby Universe S.A.S. - Vía 40 No. 77-29, Barranquilla, Colombia - Fono: (575) 353 1110 Importador: DJGM, S.A. DE C.V. Gabriel Mancera No. 1041 Col. Del Valle, Benito Juárez C.P. 03100 México, Ciudad de México R.F.C. DJG140305GN9  
Tel. (55) 67199202



# Contents

## 1 Getting Started

---

- 1 Parts of Car Seat
- 3 Accessory Use
- 5 Choosing Car Seat Mode

## 7 Rear-Facing Section

---

- 9 **Rear-Facing** Child Fit
- 11 **Rear-Facing** Vehicle Install

## 18 Forward-Facing Section

---

- 20 **Forward-Facing** Child Fit
- 22 **Forward-Facing** Vehicle Install

## 29 Securing Child in Car Seat

---

## 32 Booster Seat Section

---

- 33 Storing Harness System
- 38 **Booster** Seat Child Fit
- 40 Backed **Booster** Seat Use in Vehicle
- 43 Converting to Backless **Booster** Seat Mode
- 47 Backless **Booster** Seat Use in Vehicle

## 51 Making Adjustments to Car Seat

---

- 51 Changing Headrest/Harness Height
- 53 Changing Buckle Position

**55** Harness Adjustment for Smaller Infants

**58** Reclining Car Seat

## **59** Wash & Care

---

**59** Removing Seat Pad Set & Cleaning Parts of Car Seat

**63** Installing Seat Pad Set

## **65** LATCH & Vehicle Belt Information

---

**65** LATCH: Lower Anchor Belt

**67** Vehicle Belts

**71** Top Tether

## **72** Safety Information

---

**72** Child Restraint Use

**73** Vehicle Seating Position

**74** Installation in Vehicle

**75** Replacement & Expiration

**76** Registration & Safety Notices

**77** Aircraft Information

## **78** Warranty

---

# Parts of Car Seat

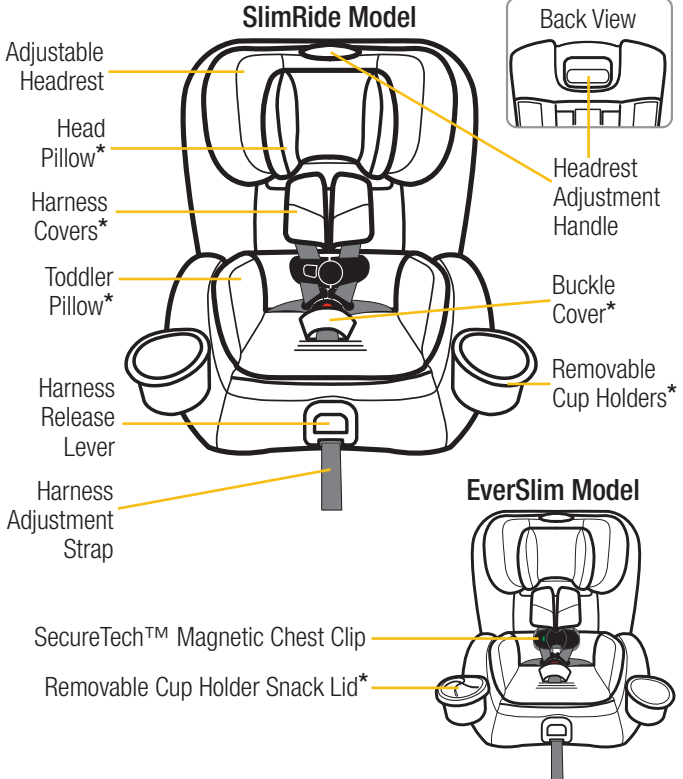

## Harness System

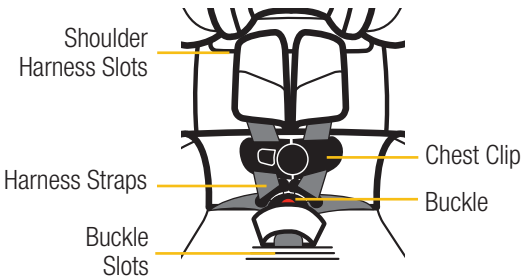

Your model may look different than one shown.

### Backless Belt-Positioning Booster Belt Path

Backless Booster Only  
Instruction Sheet Storage  
(under Backless seat pad)



Rear-Facing Level Line  
(on label)

Shell  
(Car Seat)

Forward-Facing Belt Path

Base

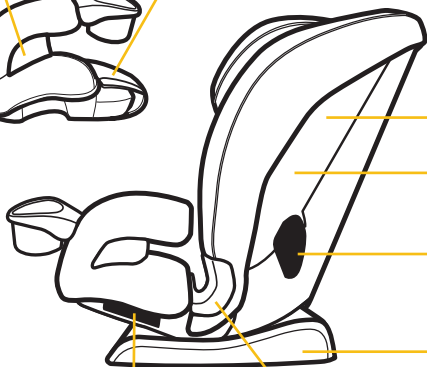

Rear-Facing Belt Path

Backed Belt-Positioning Booster Belt Path

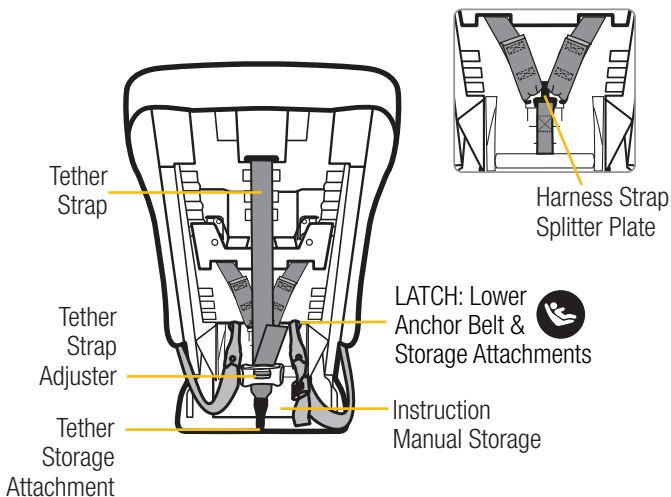

\*See pages 3-4 for Accessory Use.



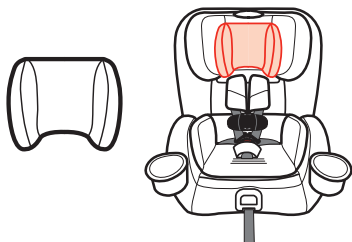

### Head Pillow & Body Pillow

(on select models)

**Only For Use in Rear-Facing Mode**

**The head and body pillows MUST be used together.**

**To remove head pillow**, from the back of the head pillow gently pull the fabric tabs out of the seams in the headrest fabric.

**To attach head pillow**, slide the fabric tabs into the slots in the seams of the headrest fabric seams.

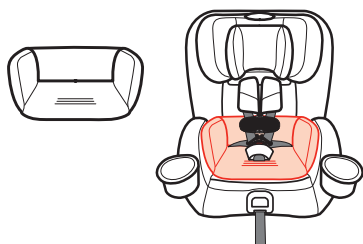

**To remove body pillow**, undo the buckle & then pull it through the slot in the pillow. Pull pillow off of seat.

**To attach body pillow**, feed buckle into matching buckle slot in pad.

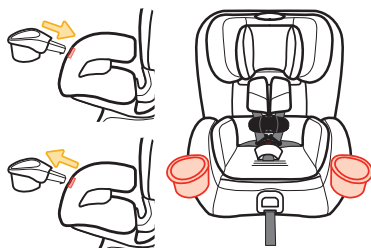

**Removable Cup Holder(s)**  
(on select models)

**For Use in All Modes**

**The cup holder(s) is top-rack dishwasher safe.**

**To attach**, push the cup holder post into the end of the armrest, firmly, until you feel a click. Pull out gently to make sure it is secure. Repeat for other side.

**To remove**, pull out on the cup holder.



## Cup Holder Snack Lid

(on select models)

### For Use in All Modes

The cup holder lid is top-rack dishwasher safe.

**To install**, fit front of cup holder lid around cup holder. Then press down around the top edges to secure the lid. **To remove**, pull off of the cup holder.



## Buckle Cover

(on select models)

For Use in **Rear-Facing Mode** or **Forward-Facing Mode**

**To remove**, undo the buckle and pull the buckle cover off of the buckle.

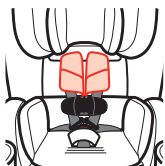

## Harness Covers

(on select models)

For Use in **Rear-Facing Mode** or **Forward-Facing Mode**

The harness covers help provide comfort to your child's neck.

**To remove**, undo the fasteners and pull the harness covers off of the harness straps.

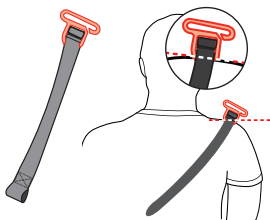

## Shoulder Belt Positioning Clip

Only for Use in **Backless Booster Mode**

**Note:** Belt clip may be stored in bag with cup holder & instruction manual in shipment.

See page 45 for storage location in car seat base.

 **WARNING:**

Measure your child's weight and height  
(**DO NOT** guess) before choosing this car seat's mode.

Your child's height, weight, and age determine how the car seat should be placed in the vehicle.

Children vary widely in body size, shape, and temperament—**please consult your doctor before switching between any modes within the limits and fit requirements of the car seat.**

### State Laws

Please be certain to follow your state's laws regarding car seat use.

## American Academy of Pediatrics Recommendations

### Infants and Toddlers

Should ride in a rear-facing car seat as long as possible, until they reach the highest weight or height allowed by their car seat.

### Toddlers and Preschoolers

Once they are facing forward, children should use a forward-facing car seat with a harness for as long as possible, until they reach the height and weight limits for their car seats.

### School-Aged Children

Once they have outgrown their forward-facing car seat, children should use a belt-positioning booster seat until the vehicle's lap and shoulder seat belt fits properly. This is often when they have reached at least 4 feet 9 inches in height and are 8 to 12 years old.

### Older Children

All children younger than 13 years should be restrained in the rear seats of vehicles for optimal protection.



## Rear-Facing Mode

**5-40 lb (2.3-18 kg) and  
19-40 in. (48-101.6 cm)**

### Rear-Facing Section

PAGE 7

### Rear-Facing Child Fit & Vehicle Install

PAGE 9 & 11



## Forward-Facing Mode

**22-65 lb (10.1-29 kg) and  
29-49 in. (73.6-125 cm) and  
at least 1 year old**

### Forward-Facing Section

PAGE 18

### Forward-Facing Child Fit & Vehicle Install

PAGE 20-22



## Backed & Backless Booster Seat Modes

**40-100 lb (18.1-45.4 kg) and  
43-52 in. (110.1-132.1 cm)**

### Booster Seat Section

PAGE 32

### Storing Harness System

PAGE 33

### Booster Seat Child Fit

PAGE 38

### Backed Booster Seat Use in Vehicle

PAGE 40

### Converting to Backless Booster Seat Mode

PAGE 43

### Backless Booster Seat Use in Vehicle

PAGE 47

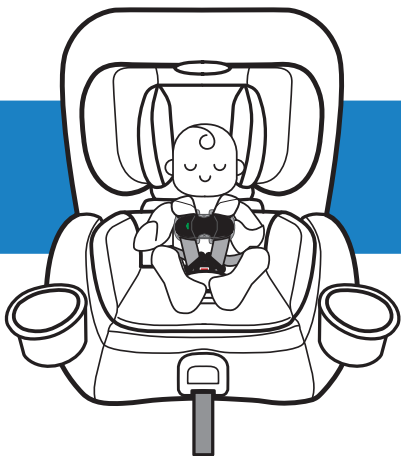

**5-40 lb (2.3-18 kg) and  
19-40 in. (48-101.6 cm)**

Children under 1 year of age **MUST** ride **Rear-Facing**.

In this car seat, your child can remain **Rear-Facing** until they outgrow any one of the following:

- **Weight Limit:** 40 lb (18 kg); **OR**
- **Height Limit:** 40 in. (101.6 cm); **OR**
- **Rear-Facing Child Fit requirements**, see pages 9-10.

Before installing the car seat in your vehicle, check your child's fit in the car seat.

This way you won't have to redo the vehicle installation to make adjustments to the car seat.

**Rear-Facing Child Fit & Vehicle Install: Pages 9-17**



## WARNING:



**NEVER** install a rear-facing child restraint in the front seat of a vehicle equipped with an active frontal airbag.

**DO NOT** use the tether for rear-facing mode.

Secure the tether strap hook to its storage attachment.

**DO NOT** use the lower anchor belt along with the vehicle lap or lap/shoulder belt.

**DO NOT** fasten multiple lower anchor hooks on the same lower anchor bar in the vehicle.

Check the vehicle belt or the lower anchor belt before each use. Use **ONLY** if the belt can be tightened properly and locked securely in place.

Even when unoccupied, this child restraint **MUST** be firmly secured to the vehicle with the lower anchor belt or with the vehicle seat belt.

This child restraint **MUST ALWAYS** face the rear of the vehicle until the child is at least 1 year old and weighs 22 lb (10 kg).



**Do not use the magnetic chest clip with children who have an implanted electronic medical device.**

**A magnet is used to help secure the chest clip locking mechanism together which may interfere with the proper function of an implanted electronic medical device.**

**Parents or caregivers who have an implanted electronic device should keep their device away from the chest clip and consult their doctor and medical device manufacturer for specific information before using this chest clip.**

If a parent/caregiver or child has an implanted electronic medical device, please contact Dorel (see back cover) for a replacement (non-magnetic) chest clip free of charge.

1



## Fully Loosen Harness Straps

Push down on the harness release lever (through the opening in the pad) while pulling out on the harness straps as shown.

2

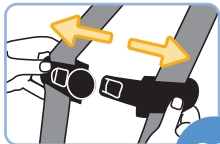

## Undo Chest Clip

Press in on the release button and pull apart.

OR

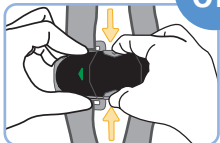

Press in on the top & bottom buttons and pull apart.

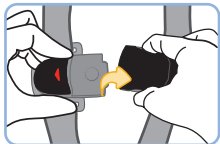

3



## Undo Buckle

It may be easier to undo the buckle by pressing in towards the top of the button.

4

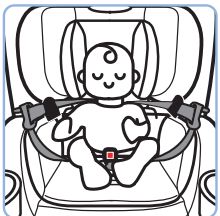

## Place Child in Car Seat

Your child's bottom and back should be flat against the car seat.

5

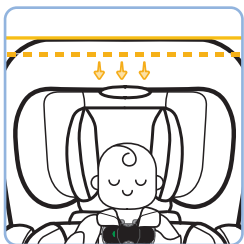

## Check Head Position

The top of your child's head **MUST be at least 1 in. (2.5 cm) below** the top of the car seat's headrest.

6

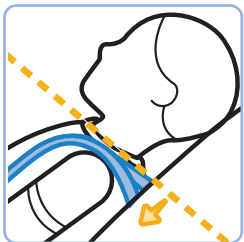

## Check Harness Strap Position

The harness strap **MUST be at or slightly below** the shoulders; never above.

7

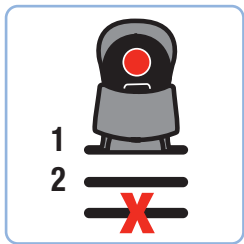

## Check Buckle Position

- Use the slot closest to your child.
- The buckle **should not be underneath or behind** your child.

**DO NOT** use the 3rd buckle slot in **Rear-Facing Mode**.



To change the harness strap height, see page 51.

To change the buckle position, see page 53.

To secure child in car seat & check harness tightness, see pages 29-31.

If you cannot achieve a snug harness fit for your child, see pages 53-57.



## Rear-Facing Vehicle Install

There are 2 different methods for install.

**Use only one:**



**Vehicle Belt**



**LATCH: Lower  
Anchor Belt**

### **WARNING:**

**DO NOT** use both the LATCH: lower anchor belt and vehicle belt at the same time to install the car seat.



Before installing the car seat in your vehicle, check to see if you need to adjust the buckle position for your child. **See page 9 for child fit.**

Once the car seat is installed, you will not be able to adjust the buckle position.

#### **Review Vehicle Owner's Manual**

Determine what kind of vehicle belts your car has and how to use them to lock a car seat in place **OR** where LATCH: lower anchor seating positions are located in your vehicle.

1



## Place Car Seat Rear-Facing in Back Seat

The car seat base **MUST** be flat on the vehicle seat.

2



## Recline Car Seat & Check Rear-Facing Level Line

i



For children **who cannot sit up unassisted**, the **Rear-Facing Level Line** on the car seat **MUST** be parallel with the ground using **Positions 2-5**.

For children **who can sit up unassisted**, you may make the car seat more upright starting from the fully reclined **Position 5**

& adjusting to more upright **Positions 4-2**.

**DO NOT** use position 1 for **Rear-Facing** mode.

See **Reclining Car Seat**, page 58.

3

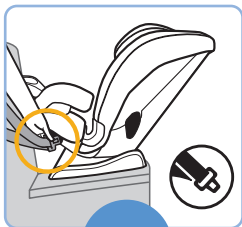

OR



## Locate Rear-Facing Belt Path & Route Vehicle Belt or Lower Anchor Belt Through It

**For the LATCH belt:** You may need to fully lengthen the belt before routing it into the belt path.

Squeeze the adjuster button and pull the belt out as shown.



i

## For Lower Anchor Belt Installation

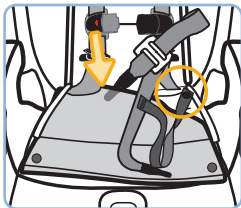

Pull front of seat pad down as shown.

Gather complete lower anchor belt, with lanyard, to side of harness strap so they do not cross over each other.

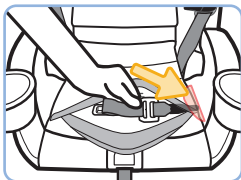

Route belt under seat pad.

Pull front of seat pad up as shown & route lower anchor belt hook under pad.

Through opening in front of seat pad, route lower anchor belt hook through **Rear-Facing Belt Path** as shown.

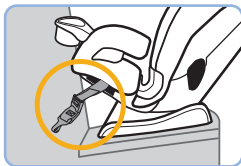

The lower anchor strap goes in **front** of the buckle as shown in step 4 on page 14.

4

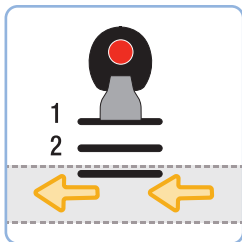

## Vehicle Belt or Lower Anchor Belt Goes:

- under the car seat pad; **AND**
- across the car seat; **AND**
- in front of the buckle; **AND**
- out the other **Rear-Facing Belt Path** opening.

**DO NOT** twist the belt.

i



Adjuster

## Finished Lower Anchor Belt Routing

The lower anchor belt adjuster can be on either side of the car seat.

5

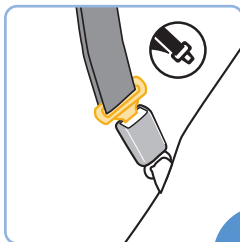

## Buckle Vehicle Belt

If your car has a **switchable retractor**, use it to lock the vehicle belt. Review page 67 of this manual or your vehicle owner's manual.

OR



## Attach Lower Anchor Belt Hooks to Vehicle's Lower Anchors

*continued on next page*

6

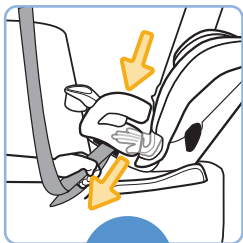

OR



## Tighten Belt

Place your hand in the car seat and firmly push the car seat down and back towards the vehicle seat. Pull the belt towards you and parallel (in line) with the belt path as shown.

**For the LATCH belt or Lap Only Vehicle Belt:** it may be easier to tighten if you route the free end of the belt back into the **Rear-Facing Belt Path**, reach into the **Rear-Facing Belt Path**, and pull the free end of the belt towards you.

7

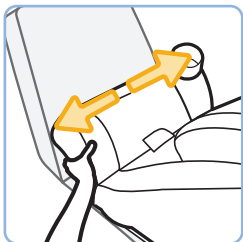

## Check Belt Tightness

Hold the **Rear-Facing Belt Path** with your non-dominant hand. Push and pull the car seat from side to side.

The car seat should not move more than **1 in.** (2.5 cm).

8

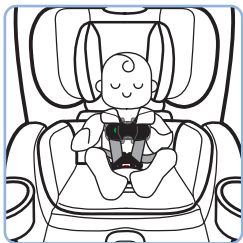

## Secure Child in Car Seat

See pages 29-31.



If the car seat moves more than 1 in. (2.5 cm), you can try:

- Pulling the belt tighter; **OR**
- Reinstalling the car seat; **OR**
- Changing to a different seating location; **OR**
- Switching to a different install method (LATCH or vehicle belt).

9



### Recheck Rear-Facing Level Line

Redo the installation if the car seat is not reclined correctly for your child. See step 2 and info box on page 12.



Only if necessary, you may place a tightly rolled towel(s) or foam pool noodle(s) under the front of the car seat base to help make the **Rear-Facing Level Line** parallel with the ground.

Check often to make sure padding is still in place and the belt is tight.



To secure child in car seat & check harness tightness, see pages 29-31.

To change the harness strap height, see page 51.

To change the buckle position, see page 53.

If you cannot achieve a snug harness fit for your child, see pages 53-57.

## FINISHED!



**Lap/Shoulder Belt**



**Lap Belt**



**LATCH: Lower Anchor Belt**

- Vehicle Belt Install:** Is the vehicle belt locked?  
See step 5.
- LATCH: Lower Anchor Belt Install:** Are the hooks securely attached to the vehicle's lower anchors? See step 5.
- Is the belt tightened enough so that the car seat does not move more than 1 in (2.5 cm) from side to side? Check the tightness of the install often to make sure it has not loosened. See steps 6 and 7.
- If your child cannot sit up unassisted, is the **Rear-Facing Level Line** parallel with the ground? See steps 2, 8, 9, and info box on page 16.



**22-65 lb (10.1-29 kg) and  
29-49 in. (73.6-125 cm) and  
at least 1 year old**

Children **MUST** be at least 1 year of age to ride **Forward-Facing**.

In this car seat, your child can remain harnessed **Forward-Facing** until they outgrow any one of the following:

- **Weight Limit:** 65 lb (29 kg); **OR**
- **Height Limit:** 49 in. (125 cm); **OR**
- **Forward-Facing Child Fit requirements**, see pages 20-21.

Before installing the car seat in your vehicle, check your child's fit in the car seat.

This way you won't have to redo the vehicle installation to make adjustments to the car seat.

**Forward-Facing Child Fit & Vehicle Install: Pages  
20-28**



**WARNING:**

**DO NOT** use the lower anchors of the child restraint anchorage system (LATCH system) to attach this child restraint when restraining a child weighing more than 45 lb (20 kg).

The vehicle belt **MUST** be used for installation if your child weighs more than 45 lb (20 kg).

When anchors are available, you **MUST ALWAYS** attach, adjust, and secure the tether (top anchorage) strap when installing the car seat in the Forward-Facing Mode with internal harness.

**DO NOT** use the lower anchor belt along with the vehicle lap or lap/shoulder belt.

Check the vehicle belt or the lower anchor belt before each use.

Use **ONLY** if the belt can be tightened properly and locked securely in place.

**DO NOT** fasten multiple lower anchor hooks on the same lower anchor bar in the vehicle.

Even when unoccupied, this child restraint **MUST** be firmly secured to the vehicle with the lower anchor belt or with the vehicle seat belt.

In this child restraint your child **MUST** be at least 1 year old and weigh 22 lb (10.1 kg) before they sit forward-facing.



**Do not use the magnetic chest clip with children who have an implanted electronic medical device.**

**A magnet is used to help secure the chest clip locking mechanism together which may interfere with the proper function of an implanted electronic medical device.**

**Parents or caregivers who have an implanted electronic device should keep their device away from the chest clip and consult their doctor and medical device manufacturer for specific information before using this chest clip.**

If a parent/caregiver or child has an implanted electronic medical device, please contact Dorel (see back cover) for a replacement (non-magnetic) chest clip free of charge.

# 1

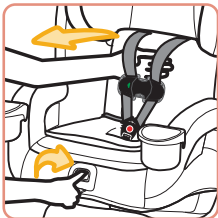

## Fully Loosen Harness Straps

Push down on the harness release lever (through the opening in the pad) while pulling out on the harness straps as shown.

# 2

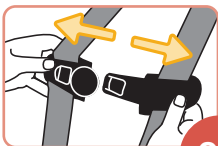

**OR**

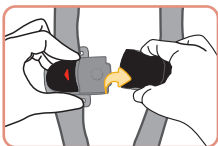
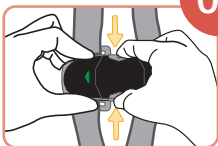

Press in on the release button and pull apart.

Press in on the top & bottom buttons and pull apart.

# 3



## Undo Buckle

It may be easier to undo the buckle by pressing in towards the top of the button.

# 4

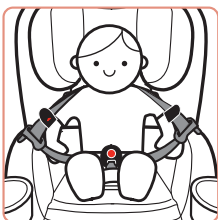

## Place Child in Car Seat

Your child's bottom and back should be flat against the car seat.

5

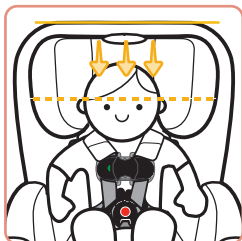

## Head Position

The tops of your child's ears **MUST be below** the top of the car seat's headrest.

6

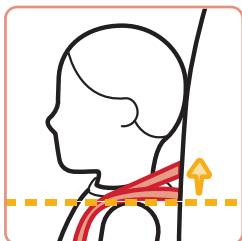

## Harness Strap Position

The harness strap **MUST be at or slightly above** the shoulders; never below.

7

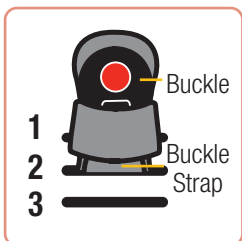

## Buckle Position

- Use the slot closest to your child.
- The buckle **should not be underneath or behind** your child.

The buckle can be used in **any** buckle slot.

i

To change the harness strap height, see page 51.

To change the buckle position, see page 53.

To learn how to check harness tightness, see pages 29-31.

There are 2 different methods for install.

**Use only one:**



## Vehicle Belt

for children up to  
65 lb (29 kg)



## LATCH: Lower Anchor Belt

for children up to  
45 lb (20 kg)

## **WARNING:**

**DO NOT** use both the LATCH: lower anchor belt and vehicle belt at the same time to install the car seat.

When anchors are available, you **MUST ALWAYS** attach, adjust, and secure the tether (top anchorage) strap when installing the car seat in the Forward-Facing Mode with internal harness.



Before installing the car seat in your vehicle, check to see if you need to adjust the buckle position for your child. **See page 20 for child fit.**

Once the car seat is installed, you will not be able to adjust the buckle position.

### **Review Vehicle Owner's Manual**

Determine what kind of vehicle belts your car has and how to use them to lock a car seat in place **OR** where LATCH: lower anchor seating positions are located in your vehicle.

1

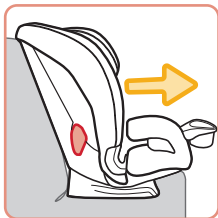

## Put Car Seat into Most Upright Position & Place Car Seat **Forward-Facing** in Back Seat

The vehicle seat back **MUST** be upright.

i

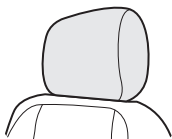

If your vehicle has a headrest that interferes with a flush car seat fit, check your vehicle owner's manual to see if it can be removed, adjusted, or if there are other possible seating locations for you to install.

2



## Locate Vehicle Top Tether Anchors

Review your vehicle owner's manual for top tether anchor locations and how to route the tether strap when there are vehicle headrests.

3

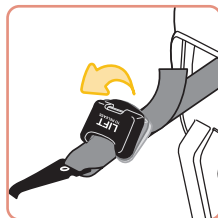

## Lift Tether Adjuster to Loosen Tether Strap

4

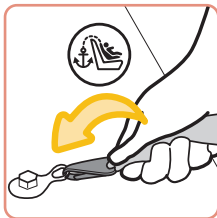

**Loosely Attach Tether Hook to Vehicle's Top Tether Anchor**

5

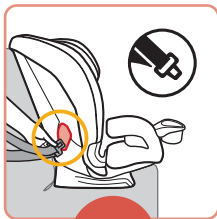

**Locate **Forward-Facing Belt Path** & Route Vehicle Belt or Lower Anchor Belt Through It**

OR



**For the LATCH belt:** You may need to fully lengthen the belt before routing it into the belt path. Squeeze the adjuster button and pull the belt out as shown.



6

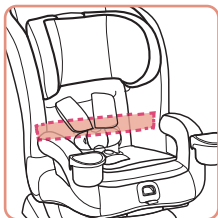

### Vehicle Belt or Lower Anchor Belt Goes:

- behind the car seat pad; **AND**
  - across the car seat; **AND**
  - out the other **Forward-Facing Belt Path** opening.
- DO NOT** twist the belt.

i

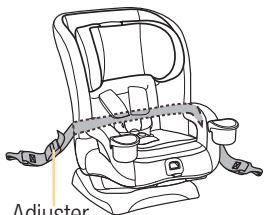

Adjuster

### Finished Lower Anchor Belt Routing

The lower anchor belt adjuster can be on either side of the car seat.

7

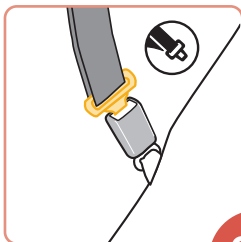

## Buckle Vehicle Belt

If your car has a **switchable retractor**, use it to lock the vehicle belt. Review pages 67-70 of this manual or your vehicle owner's manual.

OR



## Attach Lower Anchor Belt Hooks to Vehicle's Lower Anchors

8

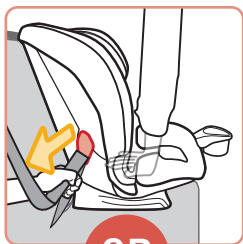

## Tighten Belt

Place your hand in the car seat and firmly push the car seat down and back towards the vehicle seat. Pull the belt towards you and parallel (in line) with the belt path as shown.

OR



**For the LATCH belt or Lap Only Vehicle Belt:** it may be easier to tighten if you route the free end of the belt back into the **Forward-Facing Belt Path**, reach into the **Forward-Facing Belt Path**, and pull the free end of the belt towards you.



9

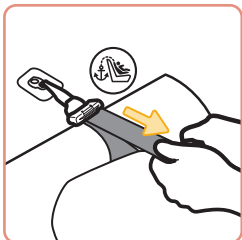

### Tighten Tether

Push firmly on the back of the car seat and pull the free end of the tether strap to remove all of the slack.

10

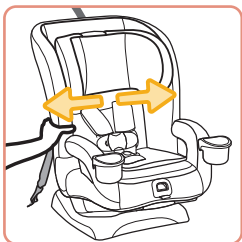

### Check Belt Tightness

Hold the **Forward-Facing Belt Path** with your non-dominant hand. Push and pull from side to side.

The car seat should not move more than **1 in.** (2.5 cm).

i

**If the car seat moves more than 1 in. (2.5 cm), you can try:**

- Pulling the belt tighter; **OR**
- Reinstalling the car seat; **OR**
- Changing to a different seating location; **OR**
- Switching to a different install method (LATCH or vehicle belt).

## FINISHED!



**Lap/Shoulder Belt + Tether**  
for children up to 65 lb (29 kg)



**Lap Belt + Tether**  
for children up to 65 lb (29 kg)

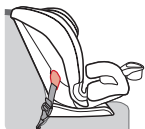

**LATCH: Lower Anchor Belt + Tether**  
for children up to 45 lb (20 kg)

- Vehicle Belt Install:** Is the vehicle belt locked? See step 7.
- LATCH: Lower Anchor Belt Install:** Are the hooks securely attached to the vehicle's lower anchors? See step 7.
- Is the belt tightened enough so the car seat does not move more than 1 in (2.5 cm) from side to side? Check the tightness of the install often to make sure it has not loosened. See steps 8 and 10.
- Has the tether been installed and tightened? See steps 4 and 9.

## ⚠️ WARNING:

**IMPLANTED  
ELECTRONIC  
MEDICAL  
DEVICES**

Do not use the magnetic chest clip with children who have an implanted electronic medical device.

A magnet is used to help secure the chest clip locking mechanism together which may interfere with the proper function of an implanted electronic medical device.

Parents or caregivers who have an implanted electronic device should keep their device away from the chest clip and consult their doctor and medical device manufacturer for specific information before using this chest clip. If a parent/caregiver or child has an implanted electronic medical device, please contact Dorel (see back cover) for a replacement (non-magnetic) chest clip free of charge.

1

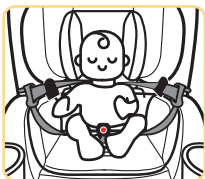

### Place Child in Car Seat

Your child's bottom and back should be flat against the car seat.

2

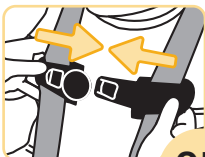

### Fasten Chest Clip

Insert right half of chest clip into left half and snap together.

OR

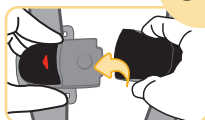

Lay the right (top) half of the chest clip over the left (bottom) half and it will automatically snap together and lock.

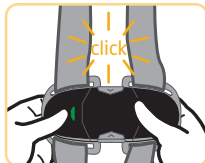

Pull gently on each half of the chest clip together to make sure it is locked.

i



When the magnetic chest clip is properly secured, the triangle will change from red to green.

3

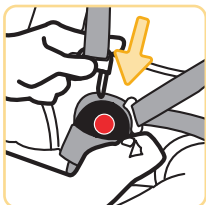

### Buckle Harness

Pull the harness straps up to make sure the buckle is locked.

4

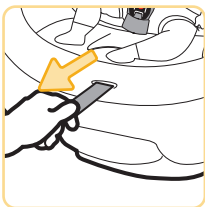

### Tighten Harness

Pull the harness adjustment strap straight out to snugly tighten the harness.

5

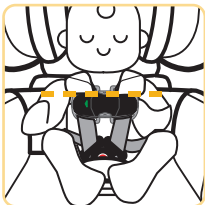

### Position Chest Clip

Slide the chest clip up the harness straps and position it at mid-chest (even with armpits) and away from your child's neck.

6

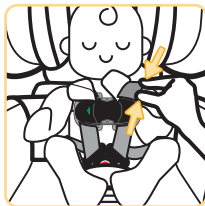

### Check Harness Tightness

Unfasten the harness covers.

Try to pinch the harness at the shoulders vertically between index finger and thumb as shown.

**If your fingers slip off**, the harness is tight enough. **If you can pinch the harness strap**, tighten more. Fasten the harness covers.

*continued on next page*

## i

A snug strap should not allow any slack.

It lies in a relatively straight line without sagging.

It does not press on the child's flesh or push the child's body into an unnatural position.

**If you cannot achieve a snug harness fit for your child, see pages 53-57.**

## FINISHED!

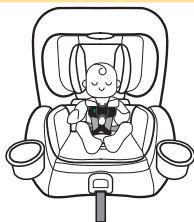

Your child is now secured in the car seat.

Check your child's fit often and make any needed adjustments to the car seat as they grow.

### To Remove Child from Car Seat:

1. Loosen Harness Strap
2. Unbuckle Harness
3. Release Chest Clip
4. Remove Child

### Troubleshooting

**1. If the buckle or harness release lever sticks: DO NOT lubricate.** Check for dropped food, sticky spilled drinks, dirt, leaves, etc.

Clean with warm water and/or remove the object with tweezers. If you cannot get the harness to adjust and remain tight with the buckle securely locked, **do not** use this car seat.

### 2. If your harness twists:

Straighten the harness each time you put your child in the car seat. Lock the buckle and tighten the harness so it will be ready for next use.

## ⚠️ WARNING:

Failure to fasten and tighten the harness system correctly may allow the child to be ejected from the child restraint in a crash or sudden stop causing serious injury or death.

**DO NOT** mistake comfort for safety. The harness system must be snugly adjusted.



**DO NOT** put snowsuits or bulky garments on your child when placing them in the child restraint.

Bulky clothing can prevent the harness straps from being tightened properly.

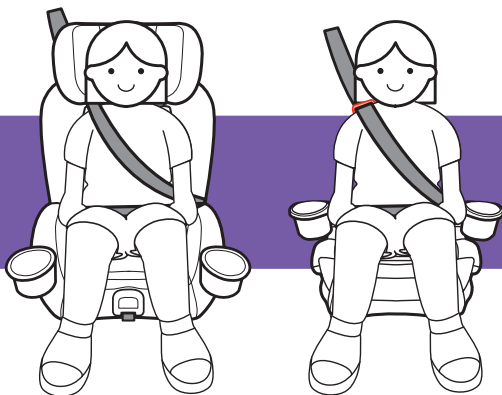
**Backed****Backless**

**40-100 lb (18.1-45.4 kg) and  
43-52 in. (110.1-132.1 cm)**

In this car seat, your child can remain in a **Booster Seat** until they outgrow any one of the following:

- **Weight Limit:** 100 lb (45.4 kg); **OR**
- **Height Limit:** 52 in. (132.1 cm); **OR**
- **Booster Seat Use in Vehicle** requirements, see page 40-42.

You **MUST** store the harness system and remove the accessories, except the cup holder(s), when using the **Booster Seat Mode**.

**To remove accessories**, see pages 3-4.

**Storing Harness System: Page 33**

**Booster Seat Child Fit: Page 38**

**Backed Booster Seat Use in Vehicle: Page 40**

**Converting to Backless Booster Mode: Page 43**

**Backless Booster Seat Use in Vehicle: Page 47**

You **MUST** remove head pillow, toddler pillow & harness covers.

To remove accessories, see pages 3 & 4.

1

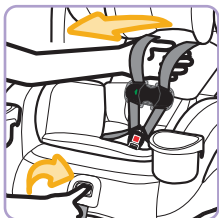

**Fully Loosen  
Harness Straps**

2

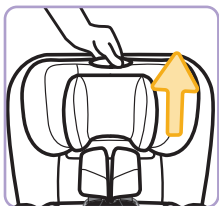

**Adjust Headrest to  
Highest Position**

3

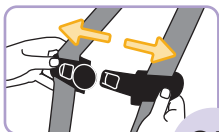

**Undo Chest Clip**

Press in on the release button and pull apart.

OR

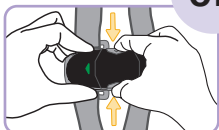

Press in on the top & bottom buttons and pull apart.

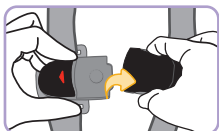

4



**Undo Buckle**

It may be easier to undo the buckle by pressing in towards the top of the button.

5

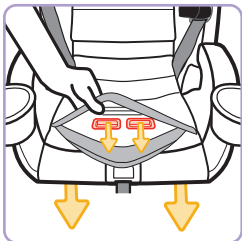

## Remove Backless Booster

Locate the backless booster release levers under the seat pad as shown.

Squeeze both levers and pull out on the backless booster to remove it from the main car seat.

6

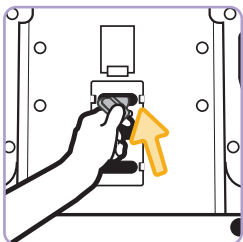

## From Bottom of Backless Booster, Rotate Buckle's Metal Retainer & Push It Up Through Booster Seat

7

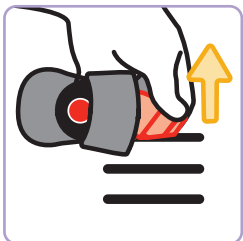

## Pull Buckle & Buckle Cover Out of Shell

Remove buckle cover from buckle.

Store the buckle cover & rest of accessories in a safe place for future use.

8

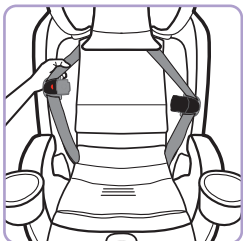

## Slide Shoulder Harness Straps Out from Slots in Headrest Pad



9

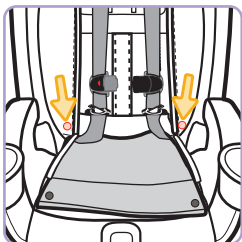

**Pull Bottom of Seat Pad Down & Locate Fasteners on Lower Back of Seat Pad**

10

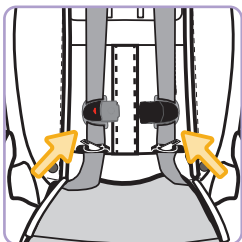

**Secure Chest Clip & Buckle Tongues Behind Seat**

From front of seat, feed left buckle tongue & left half of chest clip through opening to back as shown.

Repeat for other side.

11

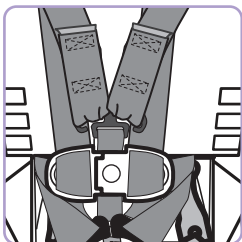

**From Back of Car Seat, Clip Chest Clip Backwards & Slide Up Harness Straps**

12

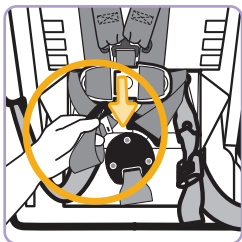

**Secure Buckle Behind Seat**

Slide buckle tongue up strap & point metal tongue down. Buckle into backward crotch buckle as shown.

Tighten harness slightly to remove slack.

13

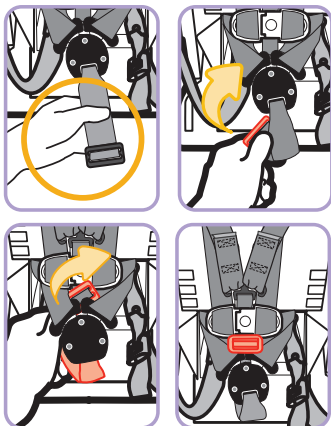

**Feed Buckle Strap's Metal Retainer Behind Buckle & Between Harness Straps As Shown**

The harness system is now stored for **Booster Seat Mode**.

14

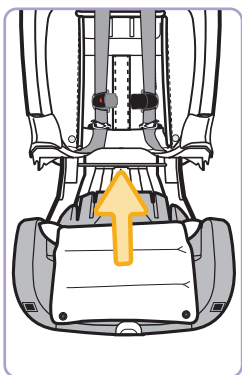

### **Attach Backless Booster to Main Shell**

Align backless booster & slide into opening at bottom of backed shell. Push firmly.

The booster seat will click on both sides when it locks into place.

Pull on backless booster to confirm it is securely attached to backed shell.



**Make sure no padding or straps are in the way of connecting the backless booster securely.**

**You will hear a loud click when backless booster is securely attached.**

**Pull on backless booster to confirm it is securely attached to backed shell.**

15

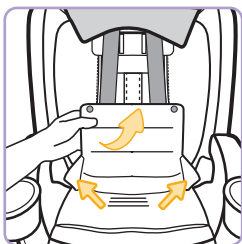

### Replace Seat Bottom Pad

Tuck side flaps behind seat bottom pad.

16

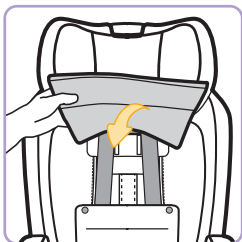

### Replace Bottom of Headrest Pad

17

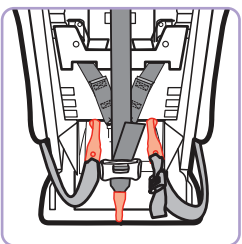

### Secure Top Tether Strap & Lower Anchor Straps To Storage Locations As Shown

Pull end of straps to tighten and remove slack.

## FINISHED!

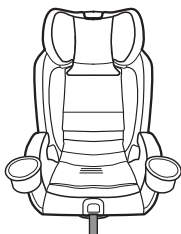

The car seat has been converted to the **Backed Booster Seat Mode**.

See page 40 for **Booster Seat Use in Vehicle**.

## Backed & Backless Booster Modes

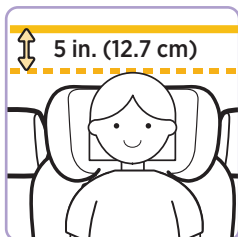

### Car Position

**DO NOT** use the booster seat if your child's head is less than 5 in. (12.7 cm) below the roof of the car.

Consult your vehicle manual for proper seatbelt usage.

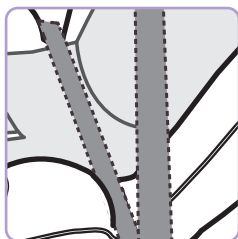

### Lap Belt Position

The lap belt should lay snugly across your child's hips; **not on their stomach.**

## Backed Booster Mode

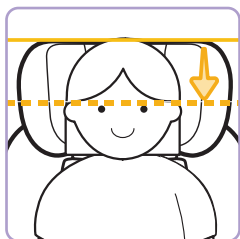

### Head Position

The tops of your child's ears should **never be above** the top of the booster seat's headrest.



### Shoulder Belt Position

The shoulder belt should lay snugly across the center of your child's shoulder and across their chest.

## Backless Booster Mode

### Head Position

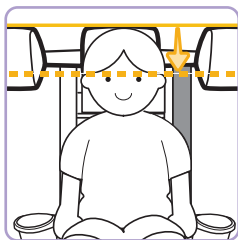

The tops of your child's ears should **never be above** the top of the vehicle seat back or vehicle headrest.

### Shoulder Belt Position



The shoulder belt should lay snugly across the center of your child's shoulder and across their chest.

To help position the shoulder belt you may need to secure the shoulder belt into the belt positioning clip.

**NOTE:** Use the shoulder belt positioning clip only if necessary to correctly position the shoulder belt on the child. See pages 45 & 46.

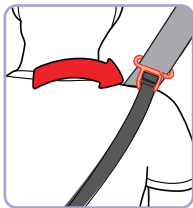
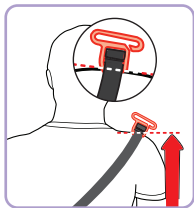

### Belt Positioning Clip Use

With child in booster seat, pull the belt positioning clip across the child's back to the top of the child's shoulders.

The top of the shoulder must be even with the line in the positioning clip as shown.

## **WARNING:**

**DO NOT** use the harness system when using as a booster seat.



**DO NOT** use LATCH when using as a booster seat. Secure the lower anchor belt and the tether strap to their storage attachments.

Use **ONLY** the vehicle's lap and shoulder belt system when restraining the child in this booster seat.

**DO NOT** use only the lap belt when using this seat as a booster seat.

The shoulder belt **MUST** always be adjusted snugly across the child's chest.

**NEVER** place shoulder belt under the child's arms or behind their back.

**DO NOT** use this booster seat if the tops of your child's ears are above the top of the booster seat's headrest.

1

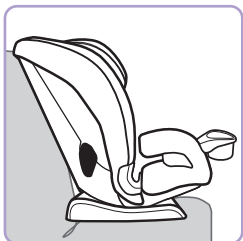

### **Place Backed Booster Seat in Back Seat of Vehicle**

The vehicle seat back **MUST** be upright.

2

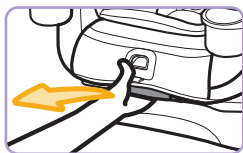

## Adjust Booster Seat To Fully Upright Position

i

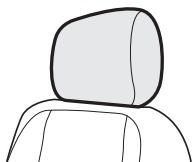

If your vehicle has a headrest that interferes with a flush car seat fit, check your vehicle owner's manual to see if it can be removed, adjusted, or if there are other possible seating locations for you to install.

3

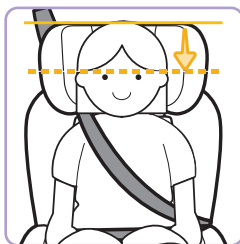

## Have Child Sit in Booster Seat

The tops of your child's ears should **never be above** the top of the booster seat's headrest.

4

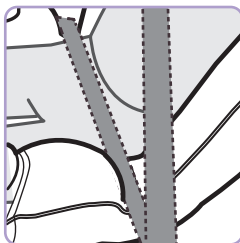

## Position Lap Belt on Child

Route **ONLY** the lap belt portion of the vehicle belt through the **Booster Seat Belt Path** as shown.

The lap belt should lay snugly across your child's hips, **not on their stomach.**

5

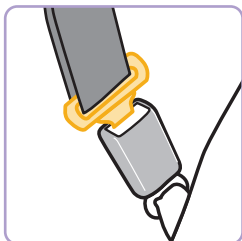

## Buckle Vehicle Belt

Pull the shoulder belt up to tighten.

6



## Position Shoulder Belt on Child

Thread the shoulder belt through the belt-positioning guide in the headrest.

Pull the shoulder belt up to tighten so that it lies snugly across the center of your child's shoulder and across their chest.

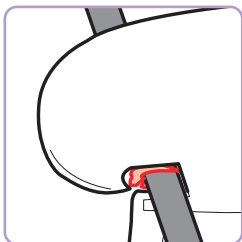

## FINISHED!



Check periodically to make sure your child has not moved out of position and loosened the shoulder belt.



**Keep the booster seat securely belted even when unoccupied.**

See **Booster Seat Child Fit**, page 38.



## Converting to Backless Booster Seat Mode

1

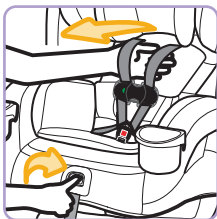

**Fully Loosen  
Harness Straps**

2

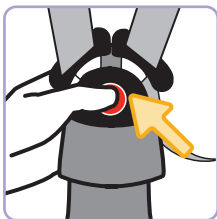

**Undo Buckle**

3

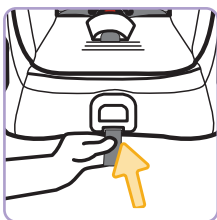

**Push Harness  
Adjustment Strap  
Through Opening  
in Bottom of Pad  
As Shown**

4

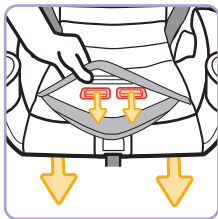

### Remove Backless Booster

Locate the backless booster release levers under the seat pad as shown.

Squeeze both levers and pull out on the backless booster to remove it from the main car seat.

5

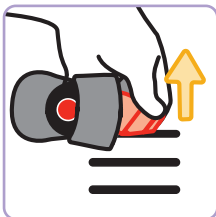

### Remove Buckle & Buckle Cover From Car Seat

Rebuckle crotch buckle to store on backed seat while not in use.

Store buckle cover & backed seat in safe place.

6

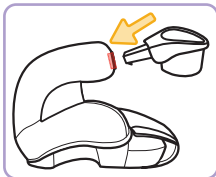

### Remove Cup Holders & Reattach to Opposite Side

Turn booster around & push cup holders into attachment openings in the booster seat as shown.

7

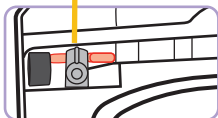

## Remove Shoulder Belt Positioning Clip from Storage Location

Turn backed car seat over & rotate plastic plate to remove clip from bottom of base.

**To store clip**, roll & flatten strap. Fit strap and clip into opening in shell as shown. Rotate plastic plate. It will click when locked into place.

8

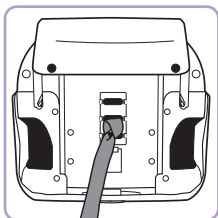
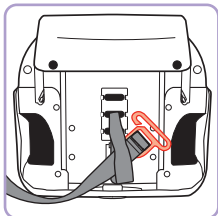
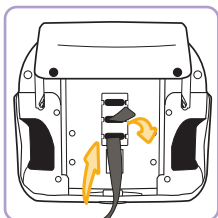

## Thread Belt Positioning Clip Strap Through Buckle Slots in Shell

From the bottom of the backless booster, feed the loop end of the strap up through the bottom buckle slot in the shell **only**.

From the top of the seat, lift the front of the seat pad and feed the loop end of the strap down through the middle slot.

From the bottom of the backless booster, thread the belt-positioning clip through loop end of strap.

Pull strap tight, as shown.

Reverse steps to remove the belt-positioning clip.

9

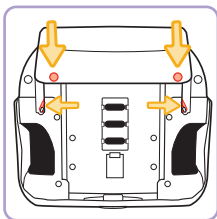

## Attach Seat Pad Fasteners

Wrap loose end of seat pad around front bottom of backless booster.

Attach both fasteners & both elastic straps as shown.

## FINISHED!

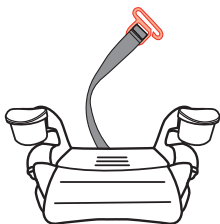

The car seat has now been converted to **Backless Booster Seat Mode**.

See pages 47-50 for **Backless Booster Seat Use in Vehicle**.

See **Booster Seat Child Fit**, page 38.

i

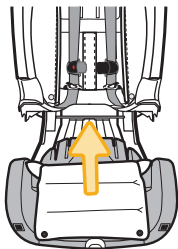

To convert to one of the backed modes, for use in **Forward-Facing** & **Rear-Facing harnessed modes** or **Backed Booster mode**, see page 36, step 13.

**To reinstall buckle**, see pages 53-54.

**To change headrest/harness height**, see pages 51-52.

**To install seat pad set**, see pages 63-64.

**To remove/store Shoulder Belt-Positioning Clip**, see page 45, steps 7 & 8.

**WARNING:**

**DO NOT** use the harness system when using as a booster seat.



**DO NOT** use this booster seat if the tops of your child's ears are above the top of the vehicle seat back or vehicle headrest.

Use only the vehicle's lap and shoulder belt system when restraining the child in this booster seat.

**DO NOT** use only the lap belt when using this booster seat. The shoulder belt must always be adjusted snugly across the child's chest.

**NEVER** place shoulder belt under the child's arms or behind their back.

By the nature of the design, backless booster car seats do not have a back or headrest. These types of booster car seats help position the vehicle belt across the body.

Any additional protection of the body or head is dependent on the protection systems of your vehicle.

Please consider this when choosing where this booster will be used in your vehicle and always consult your vehicle owner's manual.

1

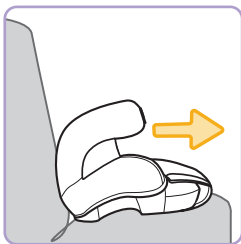

## Place Backless Booster Seat in Back Seat of Vehicle

The vehicle seat back **MUST** be upright.

2

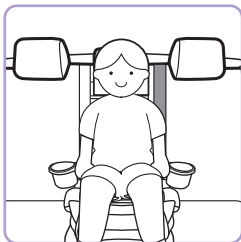

## Have Child Sit in Booster Seat

The tops of your child's ears should never be above the top of the vehicle seat's headrest.

3

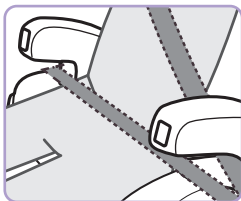

## Position Lap Belt on Child

Route the lap portion of the lap/shoulder belt through the **Booster Seat Belt Path** & under both armrests as shown.

The shoulder belt **MUST GO UNDER** the armrest on the vehicle buckle side.

The lap belt should lay snugly across your child's hips, **not on their stomach.**

4

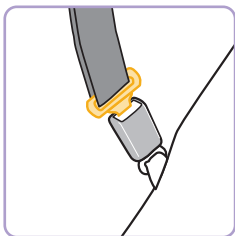

## Buckle Vehicle Belt

5



## Position Shoulder Belt on Child

Pull the shoulder belt up to tighten so that it lies snugly across the center of your child's shoulder and across their chest.

The vehicle's shoulder belt **MUST GO UNDER** the armrest on the vehicle buckle side and over the armrest on the non-buckle side.

Check periodically to ensure your child has not moved out of position and loosened the shoulder belt.

i

**To help position the shoulder belt, you may need to secure the shoulder belt into the belt-positioning clip.**

**NOTE:** Use the shoulder belt-positioning clip only if necessary to correctly position the shoulder belt on the child.

**To attach Belt-Positioning Clip Strap to backless booster booster,** see Convert to Backless Booster section pages 43-46.

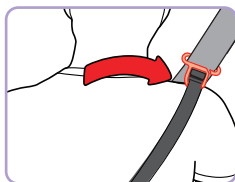
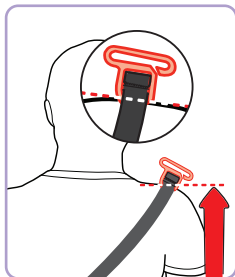

## Belt-Positioning Clip Use

With child in booster seat, pull the belt-positioning clip across the child's back to the top of the child's shoulders.

The top of the shoulder must be even with the bottom of the positioning clip as shown.

Pull the shoulder belt up to tighten so that it lies snugly across the center of your child's shoulder and across their chest.

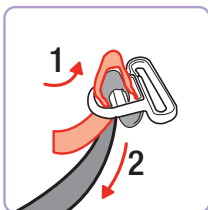

**To Lengthen:** Push free end of the strap (1) into the clip.

Pull on the opposite end of the strap (2) to remove slack as shown.

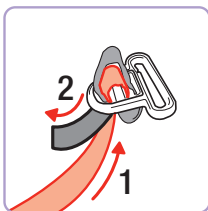

**To Shorten:** From the top of the clip, make a loop in the strap.

Push the strap up (1) as shown.

Pull free end of the strap (2) to remove the loop.



## Changing Headrest/ Harness Height

1

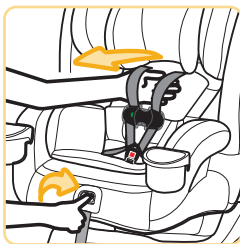

### Fully Loosen Harness Straps

Push down on the harness release lever (through the opening in the pad) while pulling out on the harness straps as shown.

2

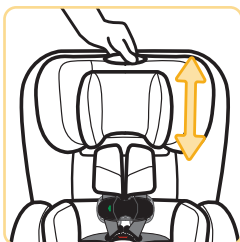

### Adjust Headrest/ Harness Height

1. Squeeze the adjustment handle lever up.

2. Move the headrest up or down to the proper height for your child.

Back View

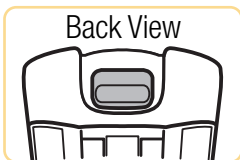

3. Release the handle to lock in place.

4. Make sure it is locked securely.

i

For **Rear-Facing Child Fit**, see page 9.

For **Forward-Facing Child Fit**, see page 20.

To learn how to check harness tightness, see pages 29-31.

If you cannot achieve a snug harness fit for your child, see pages 53-57.

Check the harness straps often for any wear or damage.

## To Use Headrest in Lowest Position:

1

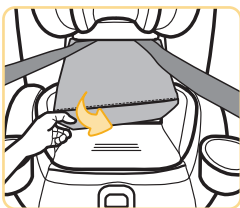

**Fold Bottom of Headrest Pad Up Underneath Middle Section of Headrest Pad**

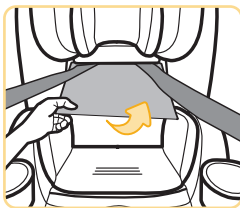

2

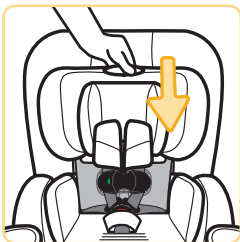

**Adjust Headrest to Lowest Position**

**NOTE:** To use headrest in higher position, do opposites of steps 1 & 2.

i



If the harness straps have been removed from the chest clip & buckle, rethread them.

The harness strap ends go through the back of the buckle tongues & through the chest clip front to back.

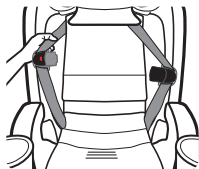

To use in harnessed mode, slide the shoulder harness straps into the slots in the headrest pad.

**To reinstall buckle,** see pages 53-54.

**To change headrest/harness height,** see pages 51-52.

## **!** WARNING:

Failure to place buckle's metal retainer completely through pad and child restraint can result in serious injury or death.

### **i**

**You must remove backless booster to change buckle position.**

**See Convert to Backless Booster**, pages 43-46.

**To reattach backless booster to main shell**, see page 36, step 13.

**1**

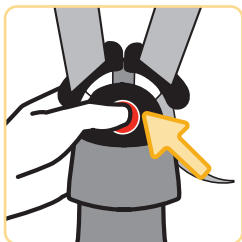

### **Unbuckle Harness**

Press in toward top of red button.

**2**

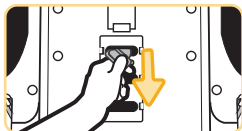

### **Pull Buckle & Buckle Cover Out of Booster Seat & Pad**

Turn the booster seat over.

Pull down on buckle's metal retainer.

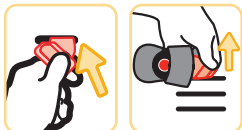

Rotate the retainer & push it up through the shell.

3

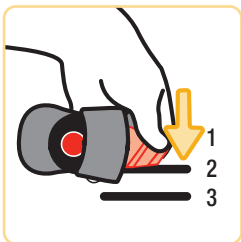

### Insert Buckle's Metal Retainer into Buckle Slot Closest to Child

From top of booster seat, tuck the ends of the buckle cover into the same pad slot as the buckle.

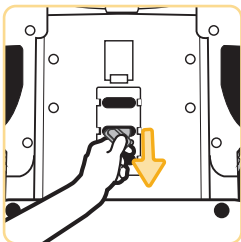

4



### Check Buckle

Pull up on the buckle to make sure it is secured.

The buckle **MUST NOT** pull out.

i

For **Rear-Facing Child Fit**, see page 9.

For **Forward-Facing Child Fit**, see page 20.

To learn how to check harness tightness, see pages 29-31.

If you cannot achieve a snug harness fit for your child, see pages 53-57.

## Harness Adjustment for Smaller Infants



If you cannot achieve a snug harness fit for your child, you may need to adjust the harness strap as shown in this section.

When using the lower shoulder harness slots for smaller children, you **MUST** use the head and body pillow and the headrest **MUST** be in the lowest position.



### WARNING:

The harness system **MUST** be installed correctly.

**DO NOT** use a child restraint with damaged harness straps.

1

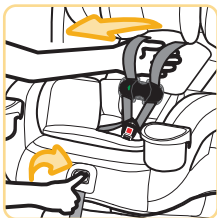

### Fully Loosen Harness Straps

Push down on the harness release lever (through the opening in the pad) while pulling out on the harness straps as shown.

2

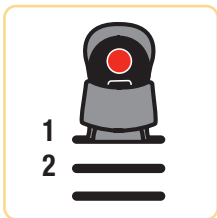

## Move Buckle to 1st Buckle Slot

To access buckle's metal retainer, you must first remove backless booster.

To remove backless booster, see pages, 43-46.

To change buckle slot, see pages 53-54.

3

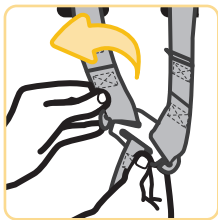

## From Back of Car Seat, Remove Harness Strap Loops From Splitter Plate

4

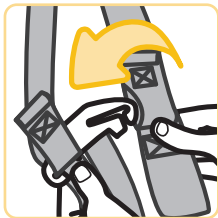

## Attach 2nd Harness Strap Loops to Splitter Plate

5

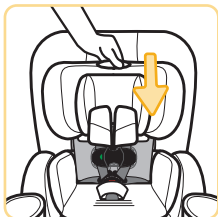
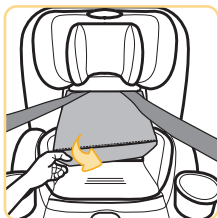

## Fold Bottom of Headrest Pad Up & Adjust Headrest to Lowest Position

The bottom section of the headrest pad will need to be folded up behind the middle section. See page 52.

i

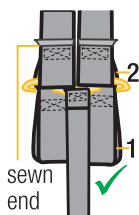

The sewn ends of the harness strap loops **MUST** face towards you.

**DO NOT** twist the harness strap or the harness adjustment strap.

Make sure the same harness strap loops are fitted completely on both sides of the splitter plate.

**To learn how to check harness tightness**, see pages 29-31.  
**If you cannot achieve a snug harness fit for your child**, see pages 53-57.

This car seat has 5 positions.

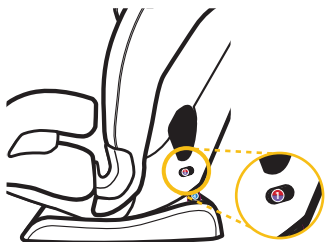

There is a small window on each side of the seat that shows which position the car seat is in.

**NOTE:** When the car seat is in **Position 5 - Fully Reclined**, the number window on the side of the seat will no longer be visible.



**Rear-Facing Mode -**  
5 Fully Reclined & 2-4 Semi-Reclined

For children **who cannot sit up unassisted**, the **Rear-Facing Level Line** on the car seat **MUST** be parallel with the ground using **Positions 2-5**.

For children **who can sit up unassisted**, you may make the car seat more

upright starting from the fully reclined **Position 5** & adjusting to more upright **Positions 4-2**.

**DO NOT** use position 1 for **Rear-Facing** mode.

**Forward-Facing Mode - 1 Fully Upright**

**Booster Seat Mode - 1 Fully Upright**

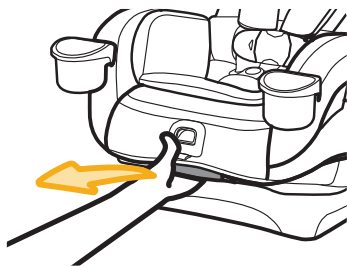

**To Recline:** Pull the recline handle out and push the top of the car seat back.

**For More Upright:** Pull the recline handle out and pull the top of the car seat forward.



## Removing Seat Pad Set & Cleaning Parts of Car Seat

**i**

You do not need to remove the harness system to remove the pad from the car seat.

**DO NOT** fully pull the harness strap out of the car seat. Leave it threaded in the hip harness slots. If removed, you will not be able to rethread it.

**To remove accessories**, see pages 3-4.

### Headrest & Backed Seat Pads

1

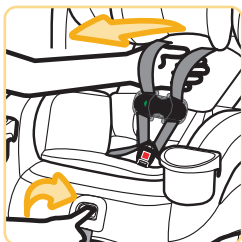

#### Fully Loosen Harness Straps

Push down on the harness release lever (through the opening in the pad) while pulling out on the harness straps as shown.

2

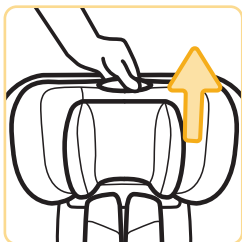

#### Adjust Headrest to Highest Position

3

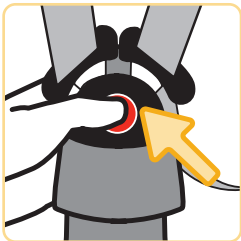

### Unbuckle Harness

Press in toward top of red button.

4

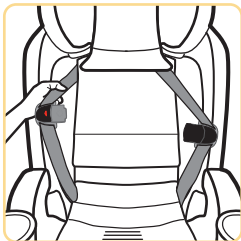

### Slide Shoulder Straps Out from Shoulder Slots in Seat Pad

5

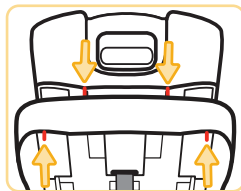

### From Behind Seat, Locate Elastic Straps

There are two elastic straps behind the top of the headrest & two on the seat back.

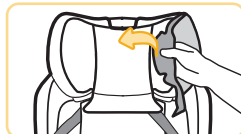

Pull elastic straps off of tabs.  
Gently remove pad from headrest.

6

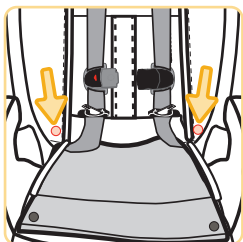

### Locate Fasteners at Bottom of Seat Pad

Undo fasteners.

7

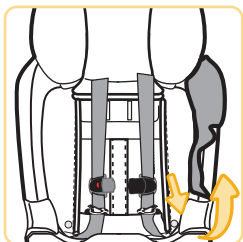

### Pull Sides of Fabric Down & Out From Around Booster Belt Path

Pull elastic straps down and out from under belt path covers.

Lift pad up off sides & top of car seat.

## Backless Booster Pad

i

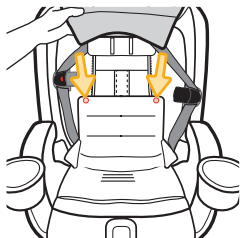

The two snap fasteners on the backless seat pad will not be attached anywhere when the backless booster is attached to the backed portion of the car seat.

1

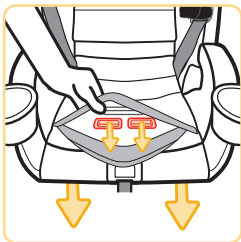

## Remove Backless Booster

See pages 43-46.

2

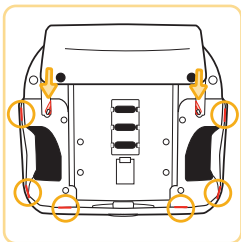

## Undo Elastic Straps Underneath Front of Backless Booster

Underneath backless booster, there are 2 elastic straps that attach to tabs in shell.

There are also 6 plastic seat pad tabs that slide into slots in the shell. Pull tabs out. Locations are as shown.

3

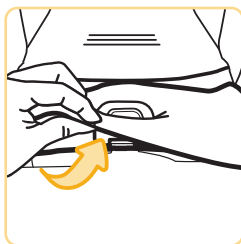

## Pull Seat Pad Down & Out from Around Harness Adjustment Cover

4

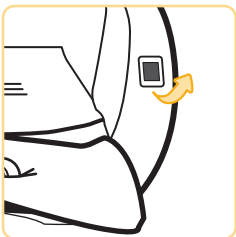

## Pull Pad Out from Around Backed Mode Cup Holder Attachments

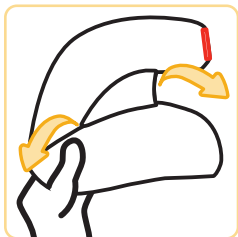

### Remove Pad From Backless Booster

Pull pad down & out from around belt path covers & backless booster cup holder attachments.

Slide pad up off of armrests & remove pad from shell.

### Cleaning Pad & Accessories

Machine wash separately with cold water on a gentle cycle. Make sure the harness covers are closed so the fastening strips are not exposed. **DO NOT** use bleach. Tumble dry separately for 10-12 minutes on low heat. Remove immediately.

### Cleaning Harness Strap

**Check the harness straps often for any wear or damage.** Spot clean using warm sudsy water and damp cloth. Spilled food and liquids on the car seat may result in mold or bacterial growth over time. These spills could also attract insects or rodents.

### Cleaning Buckle & Car Seat

Spot clean using warm sudsy water and damp cloth. **DO NOT** submerge into water.

## Installing Seat Pad Set

### Backless Booster Seat Pad

1. Fit seat pad over armrests & around Backless cup holder attachments, then fit around Backed seat mode cup holder attachments.
2. Fit pad over side and around belt path covers. Repeat for other side
3. Pull pad down & around back of Backless booster.

4. Fit pad around harness adjustment lever cover.
5. Flip plastic tabs down and slide into slots around bottom of booster.
6. Attach seat pad elastics to tabs in shell.
7. Pull front of seat pad around bottom of shell and snap fasteners into openings in shell.

### Backed Car Seat/Booster Seat Pad

1. Adjust headrest to lowest position.
2. Fit top, back of seat pad over shell & pull down around sides of seat. Attach elastic straps on top, back of shell.
3. Fit elastic strap around bottom of booster belt path.
4. Fit fabric flaps on back of seat pad around edges of car seat behind backed belt-positioning booster belt path.
5. Snap fasteners on bottom of seat pad.
6. Feed harness adjustment strap through opening at bottom of pad, from back to front.

### Headrest Pad

1. Adjust headrest to highest position.
2. Fit pad around sides of headrest & around headrest adjustment handle.
3. Attach elastic straps on back of headrest at top.

**To reattach backless booster to main shell**, see page 36, step 13.



## WARNING:

**DO NOT** fully pull the harness strap out of the car seat. Leave it threaded in the hip harness slots. If removed, you will not be able to rethread it.

**DO NOT** use the child restraint without the seat pad or with damaged harness straps.

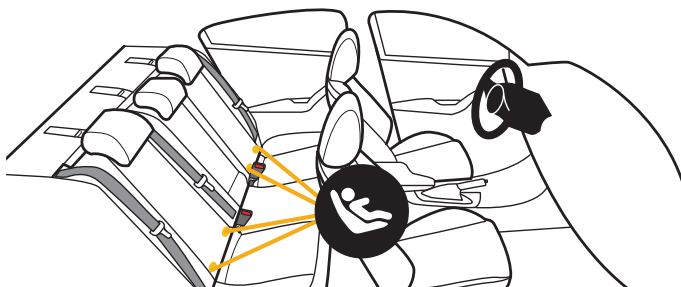

Your vehicle's features may be considerably different than those pictured here.

The lower anchors of **LATCH** (**L**ower **A**nchors and **T**ethers for **C**hildren) is a universal system for installing car seats without using vehicle seat belts. The LATCH: lower anchor belt can **ONLY** be used in vehicles that have the lower anchor bars installed in designated seating positions. Most vehicles manufactured after September 2002 are equipped with LATCH: lower anchor bars. Check your vehicle owner's manual to see which seating positions may be equipped with LATCH: lower anchor bars.

### Lower Anchor Belt Storage Location

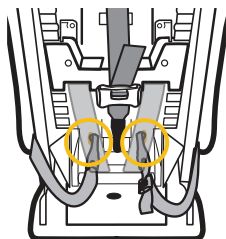

### Lower Anchor Belt Parts

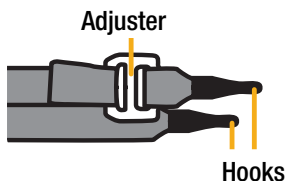

### To Remove Lower Anchor Belt from Storage Location on Car Seat

Squeeze the spring lever on the hooks and remove the hooks from the attachments in the storage location, on the shell behind the harness straps.



### To Remove Lower Anchor Belt from Vehicle's Lower Anchor Bars

1. Remove the tension from the belt by pushing down on the side of the car seat with the adjuster.
2. Press the adjuster's button to loosen the belt.
3. Squeeze the spring lever on the hooks, push the hooks back into the vehicle seat, and rotate the hooks to the side.
4. Pull the hooks off of the vehicle's lower anchor bars.

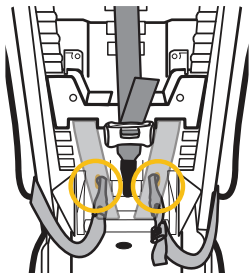

### To Store Lower Anchor Belt

The lower anchor belt **MUST** be properly stored in its storage location on the shell behind the harness straps when:

- using the vehicle belts to install the car seat; **OR**
- using the **Booster Seat Mode**; **OR**
- the car seat is not installed in the vehicle.

Secure the hooks to the attachments in the storage location on the shell behind the harness straps as shown. Gently tighten the belt to remove slack.



## WARNING:

**DO NOT** use both the lower anchor belt and vehicle belt at the same time.



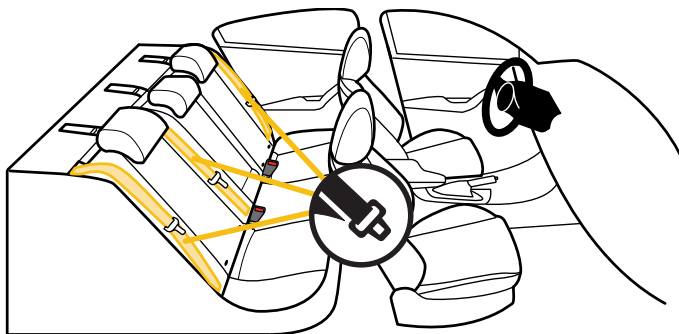

Your vehicle's features may be considerably different than those pictured here.

If LATCH: lower anchors are not an option or if your child weighs more than **45 lb** (20 kg), you **MUST** use the vehicle seat belt system to install the car seat.

**Not all vehicle belts and seating positions will work with car seats. Please go through the following steps to understand how to lock a car seat in [Rear-Facing Mode](#) or [Forward-Facing Mode](#) with a vehicle belt.**



## WARNING:

**DO NOT** use both the lower anchor belt and vehicle belt at the same time.

1

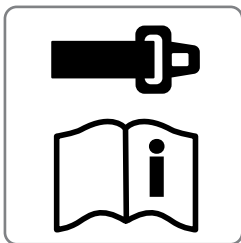

## You **MUST** Review Your Vehicle Owner's Manual

Your vehicle owner's manual will let you know which vehicle belts and seating positions car seats can be installed in.

2



## Check How This Car Seat Will Be Locked Into Place

The vehicle belt **MUST NOT** loosen after tightening.

This means there needs to be a way to lock the vehicle belt.

The ways this can be done are:

- By using the seat belt's retractor (see step 3); **OR**
- By using the seat belt's latch plate (see step 4).

3

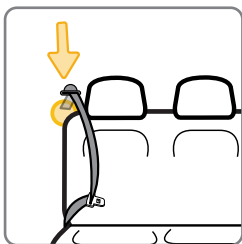

## Check Retractor

Retractors pull seat belts into stored positions and lock the belt to hold passengers in place.

See the next page for some common types of vehicle belt retractors that will work with this car seat.

## Types of Retractors

### Switchable Retractor

(most vehicles have this type)

This retractor can be switched to a locking mode.

You **MUST have the retractor in the locking mode** to use the seat belt with this car seat.

**Switching to locking mode:** Slowly pull the shoulder belt all the way out, then let it go back in **1-2 in. (2.5-5 cm)**.

As it goes back in, you will most likely hear a ratcheting sound.

Gently pull the belt to see if it has locked. You will not be able to pull any more belt out if the lock has engaged.

### Automatic Locking Retractor

This retractor always locks.

It will automatically lock after slowly pulling the seat belt out at least halfway and letting the belt go back into the retractor **1-2 in. (2.5-5 cm)**.

### Emergency Locking Retractor

**See Step 4**

**“Check Latch Plates”**

If the retractor does not lock, it is most likely an Emergency Locking Retractor. These retractors only lock during a sudden stop or collision.

You will need to determine if your seat belt's latch plate can lock the belt. See step 4, “Check Latch Plates”.

4



Locking  
Latch  
Plate



Emergency  
Locking  
Retractor with  
a Sliding Latch  
Plate

## Check Latch Plates

Latch plates are the part of the seat belt that goes into the buckle.

**To see if the latch plate locks:**

1. Buckle Vehicle Belt
2. Firmly Tug Lap Portion of Seat Belt While Pulling It Up

If the vehicle belt does not slide through the latch plate, it's locked.

If the latch plate slides up and down the vehicle belt, it is a **sliding latch plate**.

Sliding latch plates easily slip between the lap and shoulder portions of the belt.



**If you have an Emergency Locking Retractor with a Sliding Latch Plate, you must use a locking clip.**

**Please contact us for one, see the back cover of the manual.**

**Never Use the Following With  
This Car Seat:**

- Emergency Locking Retractor Lap Only Belt
- Inflatable Seat Belts

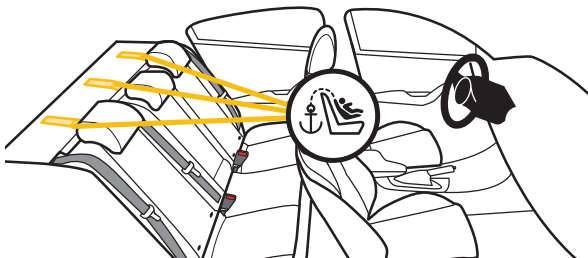

Your vehicle's features may be considerably different than those pictured here.

When anchors are available, you **MUST** always attach, adjust, and secure the tether (top anchorage) strap when installing the car seat in the **Forward-Facing Mode** with internal harness. Tethers improve the installation and stability of car seats and reduce the risk of injury. Attach the tether hook to the tether anchor designated by your vehicle manufacturer for that seating position. Check your vehicle owner's manual for more information. If the seating position does not have a tether anchor, use a different seating position or see your dealer or a qualified mechanic and have one installed.

### Storing Top Tether Strap

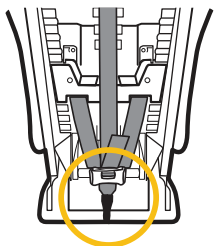

The tether strap **MUST** be properly stored in its storage location when:

- installing in **Rear-Facing Mode**; **OR**
- using the **Booster Seat Mode**; **OR**
- the car seat is not installed in a vehicle.

Attach the tether hook to its storage location as shown. Gently tighten to remove slack.

## **WARNING:**

Using this child restraint without the tether strap anchored as required by the manufacturer would be a misuse of the child restraint and, in a sudden stop or crash, could result in serious injury or death.

**DO NOT** fasten multiple tether hooks on the same tether anchor in the vehicle.

**WARNING:**

**NEVER** take your child out of the child restraint while the vehicle is moving.

**NEVER** leave your child unattended. Placing your child in a hot child restraint may result in burns.

**DO NOT** use a child restraint with damaged or missing parts.

**DO NOT** use a child restraint with cut, frayed, or damaged harnesses.

**DO NOT** substitute parts or try to modify the child restraint in any way. **DO NOT** lubricate buckles and fasteners.

**DO NOT** use any child restraint accessory except those approved by Dorel Juvenile Group.

**NEVER** allow any child to play with this child restraint; it is not a toy.

**DO NOT** remove or cover up any of the warning labels or other labels on the child restraint.

This child restraint has been certified for use in passenger vehicles. **DO NOT** use in a boat, on a motorcycle or in a cargo van or bus where there are no seat belts or tether anchors.

Read all instructions for additional warnings.

**WARNING:**

**NEVER** place a child rear-facing in a seating position with an active frontal air bag.

Check the vehicle owner's manual for more information about air bag/child restraint use.



Use the child restraint only on vehicle seats that face forward.



**DO NOT** use on seats that face the sides or rear of the vehicle.

For vehicles without a back seat, refer to your vehicle owner's manual.



**Children are safer when properly restrained in rear seating positions than in the front seating positions.**

**According to accident statistics, children in rear seating positions are statistically safer, whether you have air bags, advanced air bags, or no air bags at all.**

**If you are not sure where to place the car seat in your vehicle:**

- Consult your vehicle owner's manual; **OR**
- Contact Dorel Juvenile Group Consumer Care Department; **OR**
- Visit your local Child Passenger Inspection Station. Go to <https://www.nhtsa.gov/equipment/car-seats-and-boosters-seats> to find your closest station.

**To avoid your child being seriously burned, take the following precautions:**

- Park in the shade or where the sun does not directly hit the car seat.
- Cover the car seat with a sheet or blanket when not in use.
- Check for hot seat and buckles before placing child in car seat.

**To help protect your vehicle seat's upholstery from damage:** you may use an accessory approved by Dorel Juvenile Group or a single layer towel underneath and behind car seat.

## Installation in Vehicle



### WARNING:

Check the vehicle belt or lower anchor belt before each use. Use only if the belt can be tightened properly and locked securely in place.

Even when unoccupied, this child restraint **MUST** be firmly secured to the vehicle with the lower anchor belt or with the vehicle seat belt.

Even when unoccupied, this booster seat **MUST** be firmly secured to the vehicle with the vehicle seat belt.

In a crash or sudden stop, an unsecured child restraint or booster seat could injure occupants.



## DO NOT risk your child's safety.

To keep your child as safe as possible, Dorel Juvenile Group strongly recommends replacing the car seat even after a minor crash, even if it was not occupied at the time.

### Replacement After a Minor Crash

The National Highway Traffic Safety Administration states that for a crash to be considered minor **ALL of the following MUST be true:**

- Vehicle able to drive away from the crash site; **AND**
- Vehicle door nearest the car seat was not damaged; **AND**
- No passengers were injured; **AND**
- Airbags did not deploy; **AND**
- There is no visible damage to the car seat.

If the crash your car seat was involved in meets **ALL** the criteria, you may not need to replace the car seat.

If one or more of these criteria are not true or if you are uncertain of any of your answers, replace the car seat immediately.

### Replacement After a Moderate to Severe Crash

You **MUST** replace this car seat if it has been in a moderate to severe car crash.

This car seat is intended to protect a child in a single crash. During a crash, the car seat and all of its parts absorb crash energy which can deform or weaken it. Damage is not always visible. A damaged car seat **MUST** be replaced immediately.

### Expiration

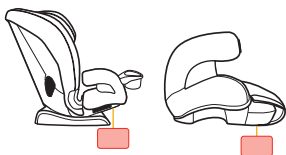

On the bottoms of the main car seat shell & the backless booster is a date of manufacture label as shown.

**DO NOT** use this car seat more than 10 years after the date of manufacture.

# Registration & Safety Notices

76

0515079		Tear Off and Mail This Part or Register Online		4348-0081D	
<b>Consumer:</b> Just fill in your name, address and email. Please print (use dark ink).					
Your Name					
Your Street Address					
City			State		Zip Code
Email Address (optional)					
Model Number		Model Name		Manufacture Date	
AB123CDE		Brand Car Seat		05/16/2015	
		L#11 B265035			

## Example of model number, manufacture date, and line code.

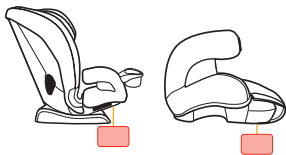

If you don't have the card or if your address changes, you will find the model number, manufacture date, and line code on the label located on the bottoms of the main main car seat shell & the backless booster.

Please complete the postage-paid registration card that came with your child restraint, and send it to us.

Child restraints could be recalled for safety reasons.

You must register this restraint to be reached in a recall.

Send your name, address, e-mail address if available and the restraint's model number and manufacturing date to:

### Dorel Juvenile Group

2525 State Street  
Columbus, IN 47201

or call 1-800-544-1108 or register online at

[www.djgusa.com/registration/carseat/us](http://www.djgusa.com/registration/carseat/us).

For recall information, call the U.S. Government's Vehicle Safety Hotline at 1-888-327-4236 (TTY: 1-800-424-9153), or go to [www.NHTSA.gov](http://www.NHTSA.gov).

This restraint is certified for aircraft use when used with the internal harness.



### Rear-Facing Aircraft Installation

Follow the steps on pages 11-17, skipping the lower anchor belt steps.



### Forward-Facing Aircraft Installation

Follow the steps on pages 22-28, skipping the lower anchor belt & tether strap steps.



### Booster Seat

This restraint is not certified for aircraft use when used as a booster seat because aircraft seats do not have shoulder belts.

Install the car seat in a window seat to avoid blocking the aisle. If the aircraft lap belt is too short, ask the flight attendant for a belt extender.

Use only on forward-facing aircraft seats. Contact the airline for their specific policies.



Some airlines may ask to see a label stating that this car seat is certified for aircraft use.

There is an airplane certification label located on the side of this car seat as shown.

## **WARNING:**

You **MUST** store the lower anchor belt and tether strap when installing with aircraft belts.

Dorel Juvenile Group, Inc. (DJG) warrants this product to the original retail purchaser as follows: This product is warranted against defective materials or workmanship for one year from the date of original purchase.

**An original receipt is required to validate your warranty.**

DJG will, at its option, provide replacement parts or replace this product. DJG reserves the right to substitute if the part or model has been discontinued.

To make a claim under this warranty, please contact our Consumer Care Department by phone: 1-800-544-1108 or text: 1-812-652-2525. Our hours of operation are from 8:00 a.m. to 6:00 p.m. EST Monday through Thursday and from 8:00 a.m. to 4:30 p.m. on Friday.

**Proof of purchase is required and shipping charges are the responsibility of the consumer.**

**Warranty Limitations:** This warranty does not include damages which arise from misuse or abuse of this product.

**Limitation of Damages:** The warranty and remedies as set forth are exclusive and in lieu of all others, oral or written, expressed or implied. In no event will DJG or the dealer selling this product be liable to you for any damages, including incidental or consequential damages, arising out of the use or inability to use this product.

**Limitation of warranties and other warranty terms and state law rights:** Any implied warranties, including implied warranties of the merchantability and fitness for a particular purpose, shall be limited to the duration and terms of the express written warranty.

Some states do not allow limitations as to how long an implied warranty lasts or the exclusion or limitation of incidental or consequential damages, so the above limitations may not apply to you. This warranty gives you specific legal rights, and you may have other rights, which vary from state to state.

Neither DJG nor the dealer selling this product authorized any person to create for it any other warranty, obligation, or liability in connection with this product.