

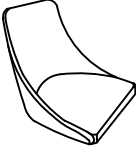



# ASSEMBLY INSTRUCTION

## SIDE CHAIR

<b>A</b> Frame Leg  1PC	<b>B</b> Seat  1PC	<b>C</b> Bolt 1/4"X1-1/2"  3PCS	<b>D</b> Lock Washer 1/4"  3PCS
<b>E</b> Flat Washer 1/4"X16mm  3PCS	<b>F</b> Allen Key 4mm  1PC		

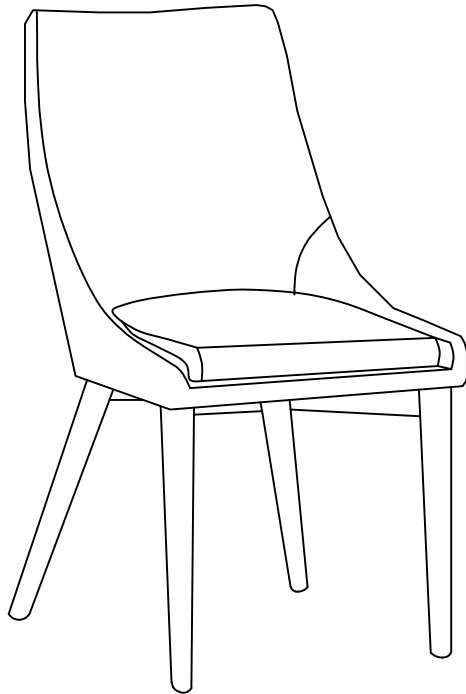

This page lists all the contents included in the box. Please take the time to identify the hardware as well as the individual components to this product. As you unpack and prepare for assembly, place the contents on a carpeted or padded area to protect them from damage.

- 
- 1** Attach the Frame Leg (A) to Seat (B) by using Flat Washer (E), Lock Washer (D), Bolt (C) with Allen Key (F).

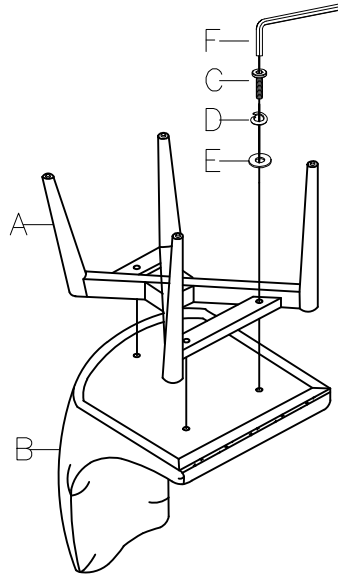

Take the Allen Key, and turn the bolts until the legs are secured. **DO NOT TIGHTEN COMPLETELY.** Stop when you feel you are adding force to tighten the bolt.

- 
- 2** Adjust the Pre-installed Levelers to be level with the ground.

Stand chair up on an even surface and check that it is balanced. If there is a slight wobble, apply downward pressure in the corner where a leg is uneven. Keeping pressure in that corner, tighten all bolts. If balanced, apply downward pressure evenly in the center and tighten all bolts. Do not over-tighten beyond hole depth.

Helpful Tip:

- Instead of applying downward pressure while reaching under to tighten bolts, have someone sit on the chair while you tighten the bolts.

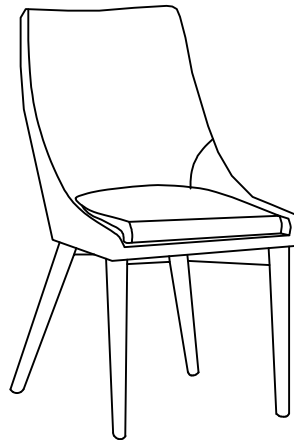

---

#### Cleaning & Care

Treat surface with care. Surface is resistant to scratches but is not scratch resistant. Clean surfaces with a dry or damp soft cloth. Do not use abrasive cleaners. Hardware may loosen over time. Periodically check that all connections are tight.