

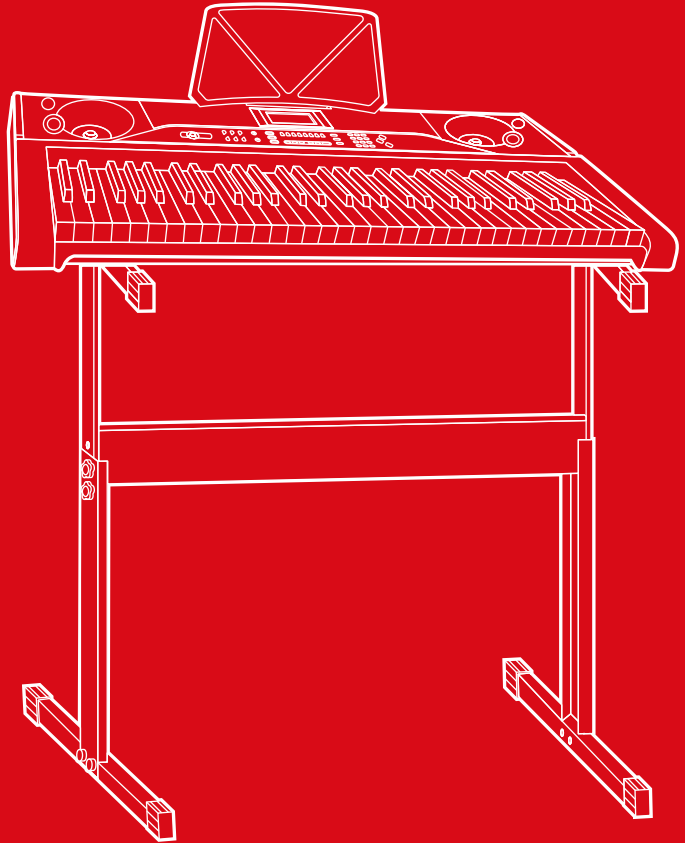

bestchoiceproducts



INSTRUCTION MANUAL

61-Key Electronic Teaching Keyboard

TOOLS REQUIRED



WRENCH



1 PERSON
ASSEMBLY



APPROXIMATELY
15 MIN.
ASSEMBLY

HARDWARE

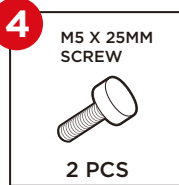
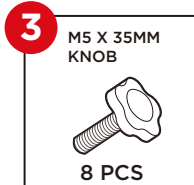
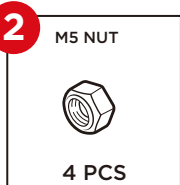
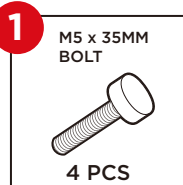

PARTS

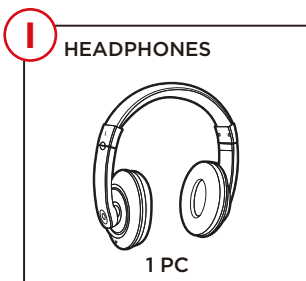
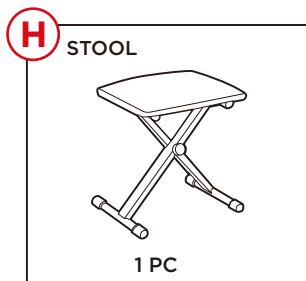
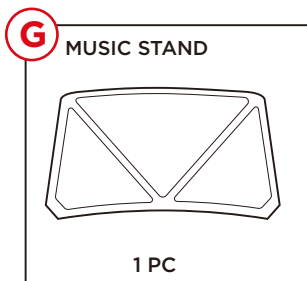
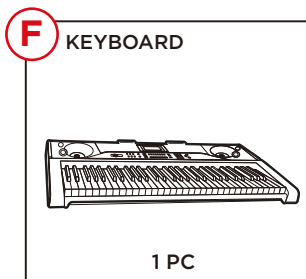
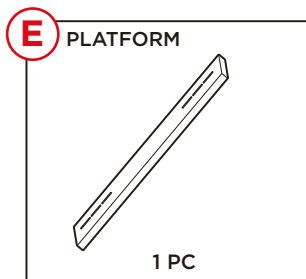
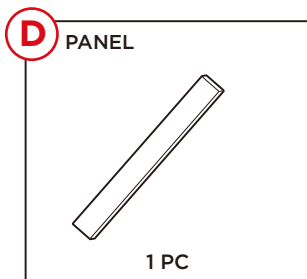
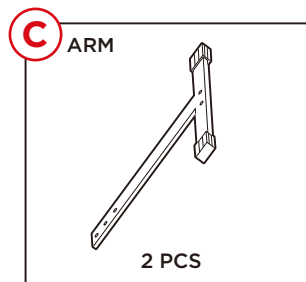
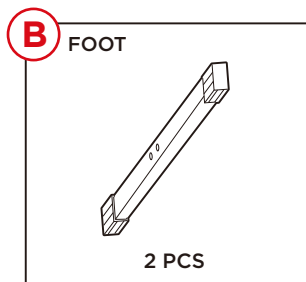
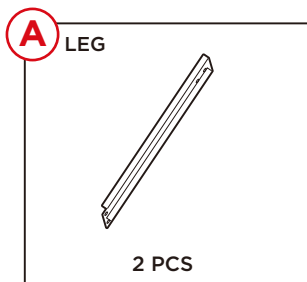

PRODUCT ASSEMBLY

Please retain these instructions for future reference.

1. Assemble the stand.
2. Attach the part F keyboard with two part 4 screws.
3. Insert the part G music stand.

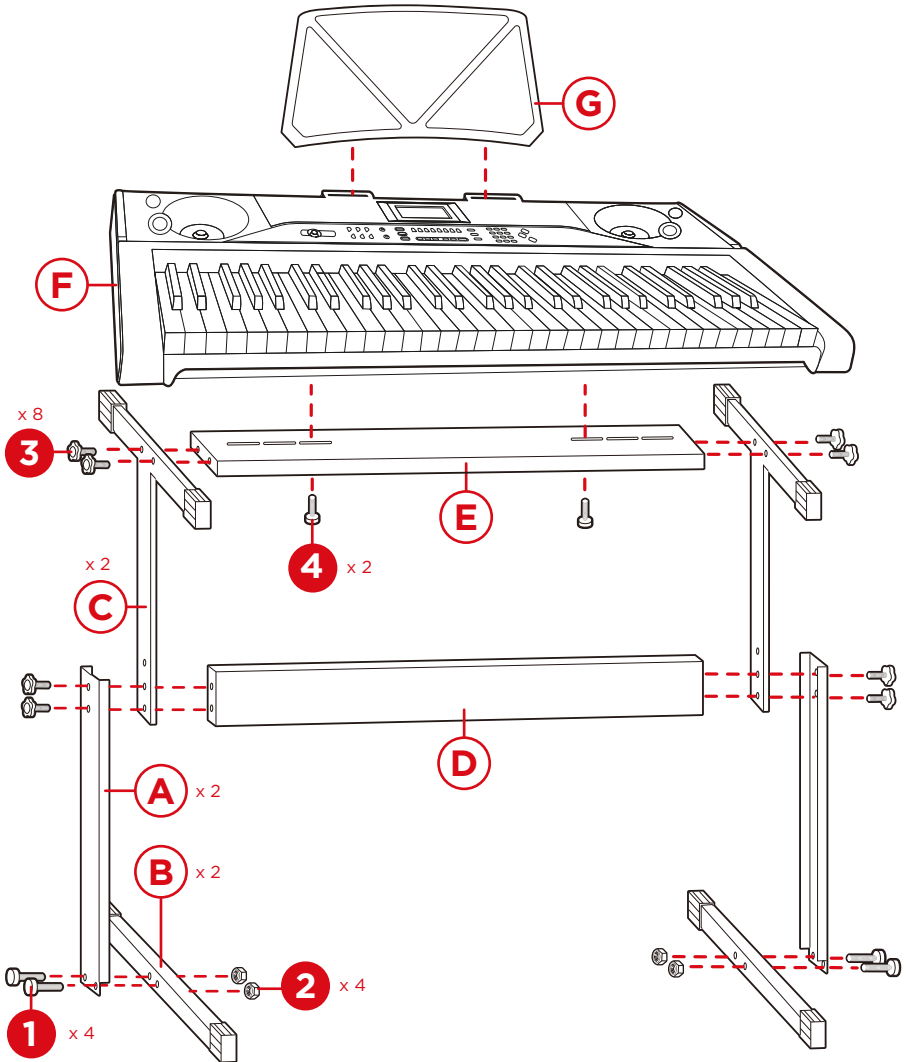

REAR PANEL

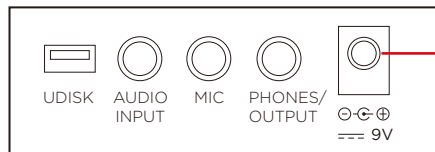

FRONT PANEL

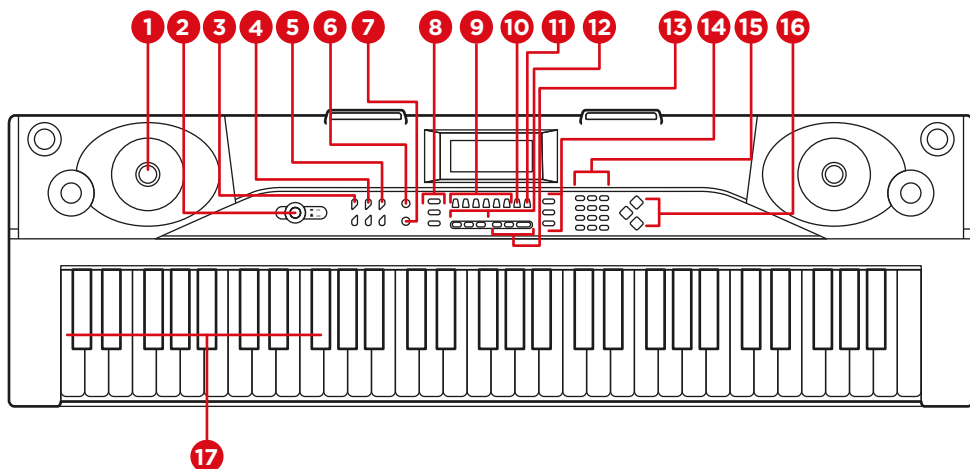

- | | | |
|--|---|--|
| <p>1. Speaker</p> <p>2. Power</p> <p>3. Master Volume</p> <p>4. Accompaniment Volume</p> <p>5. Tempo</p> <p>6. Single</p> <p>7. Fingered</p> <p>8. • Sync
• Fill-in
• Start/Stop</p> | <p>9. Media Player Controls
• MP3 Volume Control
• Previous/Next
• Play/Pause
• Sequence/Random/Single</p> <p>10. Split</p> <p>11. Key lighting</p> <p>12. 3-Step Lesson
• One Key
• Follow
• Ensemble</p> <p>13. • Sustain
• Vibrato
• Keyboard Percussion</p> | <p>14. • Record
• Program
• Play</p> <p>15. Numbers</p> <p>16. • Timbres
• Demo Song
• Rhythm</p> <p>17. Chord Keyboard: For use with single-finger chords</p> |
|--|---|--|

DIGITAL DISPLAY

On standby, screen will display the tempo. Press “START/STOP” to play the selected rhythm. Press “TEMPO +” or “TEMPO -” to increase or decrease the tempo.

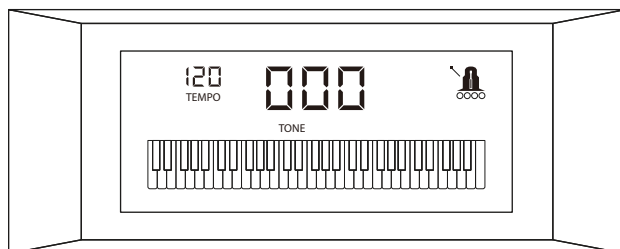

NOTE: When turned on, keyboard will default to 000 timbre and 000 rhythm with 120 beats per minute (BPM) tempo.

PERFORMANCE PREPARATION

Using Power Adapter

Do not use any other power supply adapter other than the one supplied with this unit. Connect one side to the power supply socket on the back-panel and the other side to an outlet. Note: the input voltage should be compatible with the outlet power.









Headphone Jack

- Turn off keyboard before connecting external speakers or audio devices to keyboard. Connect these devices via the "PHONES/OUTPUT" port on the back of the keyboard.
- Insert headphones (not included) into the "PHONES/OUTPUT" jack on the back of the instrument. The speaker will automatically turn off when headphones are in use. WARNING: Hearing loss can occur if headphones are used at too high of a volume.

Mic Input and Audio Input

- You can connect a microphone (not included) via the "MIC" port to use with the keyboard.
- You can play audio through the computer speakers. To do so, first turn off the keyboard. Plug in your device to the keyboard via the "AUDIO INPUT" jack. Then, turn on the keyboard.

Playing Music from an External Device

- Insert a USB flash drive into the "UDISK" port behind the keyboard. The keyboard only supports USB drives up to 32GB.
- Press  to adjust the volume.
- Press  to go to the previous track, press  to go to the next track, press  to play/pause a track, press  to stop the audio. Press  /  /  to cycle through continuous, random, or single playback.

BASIC PERFORMING METHOD

Press "POWER ON/OFF" to turn on keyboard. The LED display will light up and show the preset tempo: "120."

Light-Up Keyboard

The keyboard features a light-up function. Light hints can be provided while in the learning, playing, and demo song modes. Press "KEY LIGHTING" to enable or disable the lighting mode.

Master Volume Adjustment

- Press "MASTER VOL +" or "MASTER VOL -" to increase or decrease the overall volume.
- Press both buttons at the same time to reset the volume to default.
- Master volume can also control the accompaniment volume.

Accompaniment Volume Adjustment

- Press "ACCOM VOL +" or "ACCOM VOL -" to increase or decrease the accompaniment volume.
- Press "ACCOM VOL +" or "ACCOM VOL -" at the same time to reset the volume to default.

Timbre Selection

- There are 255 pre-programmed timbres, labeled from "000" to "254".
- To select the timbre at any time, press "TIMBRE and" "tnE" will show on the display. Select the timbre by pressing the corresponding numbers or the "+/-" buttons.

Playing Percussion

There are 61 keyboard percussions pre-programmed into the keyboard. Press "KEYBOARD PERCUSSION" to change the keyboard to a percussive instrument. Press the button again to stop this function.

BASIC PERFORMING METHOD

Playing Demonstration Songs

- The keyboard has 50 pre-programmed songs, numbered "00" to "49."
- Press the "DEMO SONG" button to play all demo songs in order. Press the "DEMO SONG" button again to stop playing the demo song.
- Press the number buttons or "+/-" buttons during demo mode to select a demo song.
- You can change the timbre of the demo song by selecting the "TIMBRE" button while the demo song is playing, and selecting the timbre in the same way as normal.
- Press "START/STOP" or press "DEMO SONG" to stop playing the demo song.

EFFECT CONTROL

Sustain Function

Press the "SUSTAIN" button, "SUS" will show on the display, and the sustain function will activate. Press this button again to disable the sustain effect.

Vibrato Function

Press "VIBRATO" button, "VIB" will show on the display, and the vibrato function will activate. Press this button again to disable the vibrato effect.

AUTO RHYTHM

Rhythm Selection

The keyboard provides 255 pre-programmed rhythms, from "000" to "254." Press the "RHYTHM" button and "rhy" will display on the screen. Press the corresponding numbers or "+/-" to select other rhythms.

Rhythm Control

- Press "START/STOP" to play the selected accompaniment rhythm.
- Press "SYNC" and "syn" will be shown on the screen. The first 19 keys from the left are the chord keyboard, and can be played with the accompaniment rhythm.
- Press "FILL IN" to have an intermezzo piece play during the accompaniment rhythm. To continue the fill-in melody, simply hold down the "FILL IN" button.
- To stop the accompaniment rhythm, press the "START/STOP" button.

Tempo Adjustment

Press "TEMPO +" or "TEMPO -" to increase or decrease the tempo. Pressing the two buttons at the same time will reset the tempo to the default.

AUTO BASS CHORD







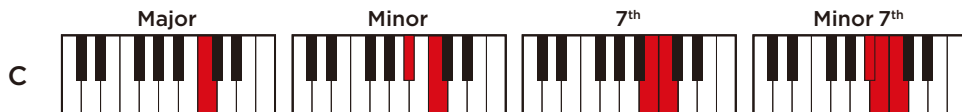



































Single-Finger Chord

While the rhythm is active, press "SINGLE" and "SIN" will show on the display. You can play a single chord using the chord keyboard (first 19 keys from the left). Press "SINGLE" again to disable the function.

Single-Finger Chord Fingering



AUTO BASS CHORD

	Major	Minor	7 th	Minor 7 th
C#				
D				
D#				
E				
F				
F#				
G				
G#				
A				
A#				
B				

Fingered Chord

While the rhythm is active, press "FINGERED" and "FIN" will show on the display. You can now play fingered chords using the chord keyboard. Press "FINGERED" to disable the function.

AUTO BASS CHORD

Fingered Chord Fingering (C Key)

Note: the following diagram only shows fingered chord fingering for the key of C. Transpose the fingering accordingly to play in other keys.

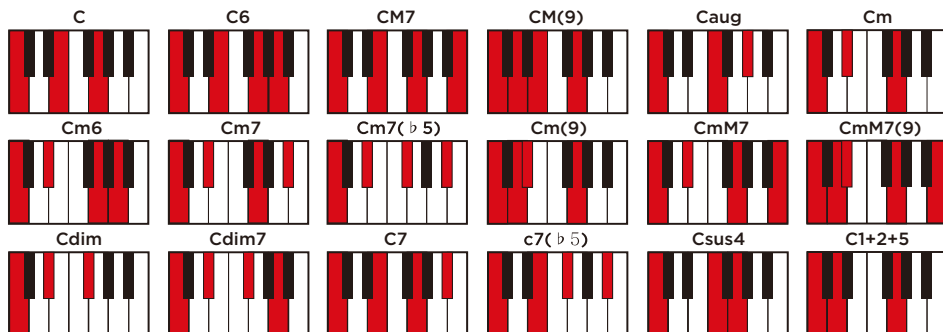

RECORDING AND RHYTHM PROGRAMMING

Recording

- Press the "REC" button to enable the recording function and "REC" will display on the screen. All notes played while the recording function is active will be recorded. When the memory is full, "FUL" will display on the screen. Press "REC" to end recording.
- Press the "PLAY" button to play back the recorded notes and "PLAY" will show on the display. After playback is complete, recording mode will start again and "REC" will appear on the display. You can record some more or play back the notes again by pressing "PLAY" again.
- Press "START/STOP" or press "REC" again to disable the recording function and to clear the recorder.

Rhythm Programming

- Press "PROG" to enable rhythm programming, "PRG" will display on the screen. Keyboard percussion mode will automatically activate. You can program custom rhythms from this mode.
- 32 percussive rhythms maximum can be programmed. "FUL" will show on the display when there is no more memory for rhythms and the function will stop automatically.
- Press "PLAY" to playback the programming rhythm. Press "PLAY" again to stop the playback and enter programming mode again.
- Press "START/STOP" or press "PROG" again to disable the programming function; all recorded rhythms will be removed.

LIGHT-UP KEY THREE-STEP INTELLIGENT TEACHING

One-Key

- Press "ONE KEY" to enable the one-key teaching function. You can select the song to be learned by pressing the number buttons or the "+/-" buttons.
- The keyboard will light up according to the main notes, indicating what notes should be played. The keyboard will continue playing even if you make mistakes.
- After the song is finished, the same song will start again.
- Press "START/STOP" or "ONE KEY" to stop the learning mode.

LIGHT-UP KEY THREE-STEP INTELLIGENT TEACHING

Follow

- Press "FOLLOW" to enable the follow teaching function. You can select the song to be learned by pressing the number buttons or the "+/-" buttons.
- The keyboard will light up according to the main notes, indicating what notes should be played. The keyboard will wait for you to play the correct notes before continuing.
- Press "START/STOP" or "FOLLOW" to stop the learning mode.

Ensemble

- Press "ENSEMBLE" to enable the ensemble teaching function. You can select the song to be learned by pressing the number buttons or the "+/-" buttons.
- The keyboard will light up according to the main notes, indicating what notes should be played. The keyboard will wait 3 seconds for you to play the correct notes (for the correct duration) before continuing.
- Press "START/STOP" or "ENSEMBLE" to stop the learning mode.

TIMBRES

000 Acoustic Grand Piano	026 Synth Bass 2	052 Honky-tonk Piano
001 Rhodes Piano	027 Violin	053 Harpsichord 1
002 Chorused Piano	028 Viola	054 Clavi 1
003 Celesta 1	029 Cello	055 Glockenspiel 1
004 Music Box 1	030 Orchestral Harp	056 Tubular Bells 1
005 Vibraphone	031 String Ensemble 1	057 Dulcimer 1
006 Marimba 1	032 Trumpet	058 Drawbar Organ 1
007 Xylophone 1	033 Trombone	059 Tango Accordion 1
008 Percussive Organ	034 Tuba	060 Electric Guitar (Muted) 1
009 Rock Organ	035 French Horn	061 Overdriven Guitar 1
010 Church Organ	036 Brass Section	062 Contrabass 1
011 Reed Organ 1	037 Synth Brass 1	063 Tremolo Strings
012 Accordion	038 Soprano Sax	064 Pizzicato Strings 1
013 Harmonica	039 Alto Sax 1	065 Timpani
014 Acoustic Guitar (Nylon)	040 Tenor Sax	066 String Ensemble 2
015 Acoustic Guitar (Steel)	041 Baritone Sax	067 Synth Strings 1
016 Electric Guitar (Jazz)	042 Oboe	068 Synth Strings 2
017 Electric Guitar (Clean)1	043 Bassoon	069 Choir Aahs
018 Distortion Guitar	044 Clarinet	070 Voice Oohs
019 Acoustic Bass	045 Piccolo	071 Synth Voice
020 Electric Bass (Finger)	046 Flute	072 Orchestra Hit
021 Electric Bass (Pick)	047 Pan Flute	073 Muted Trumpet 1
022 Fretless Bass	048 Lead (Square)	074 Synth Brass 2
023 Slap Bass 1	049 Banjo	075 English Horn 1
024 Slap Bass 2	050 E-Tone Piano	076 Recorder
025 Synth Bass 1	051 Electric Grand Piano	077 Blown Bottle 1

TIMBRES

- 078 Shakuhach
- 079 Whistle
- 080 Ocarina
- 081 Lead (Sawtooth)1
- 082 Lead (Calliope)1
- 083 Lead (Bass+Lead)1
- 084 Pad (Warm)1
- 085 Sitar
- 086 Shamisen 1
- 087 Koto 1
- 088 Kalimba 1
- 089 Bag Pipe 1
- 090 Fiddle 1
- 091 Shanai 1
- 092 Tinkle Bell
- 093 Agogo 1
- 094 Steel Drums
- 095 Woodblock 1
- 096 Taiko Drum
- 097 Melodic Tom 1
- 098 Synth Drum
- 099 Reverse Cymbal
- 100 Jungle Bass 1
- 101 Pi Pa 1
- 102 Feedback Gt. 1
- 103 Uilleann Harp 1
- 104 Jazz Bass 1
- 105 Flugel Horn 1
- 106 Muted Horn 1
- 107 Wood Barafon 1
- 108 Electric Piano 1
- 109 Multi Reed 1
- 110 Guitar Pinch 1
- 111 Multi Wind 1
- 112 Clavi 2
- 113 Celesta 2
- 114 Harpsichord 2
- 115 Mellow Fm 1
- 116 Pi Pa 2
- 117 Upright Piano 1
- 118 Electric Piano 2
- 119 Hard Vibe 1
- 120 Wood Barafon 2
- 121 Music Box 2
- 122 Marimba 2
- 123 Santur
- 124 Reed Organ 2
- 125 Puff Harmonica 1
- 126 Ukulele 1
- 127 12-str. Guitar 1
- 128 Guitar Pinch 2
- 129 Slow Violin 1
- 130 Bright String 1
- 131 Jungle Bass 2
- 132 Indian Flute 1
- 133 Clavi 3
- 134 Celesta 3
- 135 Church Bells
- 136 Marimba 3
- 137 Dulcimer 2
- 138 Reed Organ 3
- 139 Electric Guitar (Clean) 2
- 140 Koto 2
- 141 Xylophone 2
- 142 Shanai 2
- 143 Dulcimer 3
- 144 English Horn 2
- 145 Electric Guitar (Clean) 3
- 146 Shamisen 2
- 147 Koto 3
- 148 Kalimba 2
- 149 Steel Bell 1
- 150 Alto Sax 2
- 151 Woodblock 2
- 152 Synth Harpsi. 1
- 153 Attack Clav. 1
- 154 Crystal 1
- 155 Bag Pipe 2
- 156 Barafon 1
- 157 Organ Flute 1
- 158 Kalimba 3
- 159 Reed Horn 1
- 160 Hard Vibe 2
- 161 Twin Trombones 1
- 162 Synth Harpsi. 2
- 163 Attack Clav. 2
- 164 Chorus Guitar 1
- 165 Steel Bell 2
- 166 Tsugaru
- 167 Oct Harp 1
- 168 Bodhran 1
- 169 Tubular Bells 2
- 170 Suona
- 171 Castanets
- 172 Attack Harp 1
- 173 Electric Vibraphone 1
- 174 Soft Sax 1
- 175 Soft Clav. 1
- 176 Soft Guitar 1
- 177 Grow Guitar 1
- 178 Didgeridoo 1
- 179 Attack Barafon 1
- 180 Mute Barafon 1
- 181 Nay 1
- 182 Soft Santur
- 183 Dual Horns 1
- 184 Hard Barsoon 1
- 185 Tron Flute 1
- 186 Kawala 1
- 187 Jazz Organ 1
- 188 Soft Accord 1
- 189 Wind Organ 1
- 190 Viola Attack 1
- 191 Bari & Tenor 1
- 192 Soft Sax 2
- 193 Attack Harp 2

TIMBRES

- 194 Didgeridoo 2
- 195 Dual Horns 2
- 196 Hard Barsoon 2
- 197 Kawala 2
- 198 Soft Guitar 2
- 199 Mute Barafon 2
- 200 Lead (Bass+Lead) 2
- 201 Melodic Tom 2
- 202 Grow Guitar 2
- 203 Lead (Sawtooth) 2
- 204 Jazz Bass 2
- 205 Chorus Guitar 2
- 206 Feedback Gt. 2
- 207 Fiddle 2
- 208 Organ Flute 2
- 209 Flugel Horn 2
- 210 Crystal 2
- 211 Soft Clav. 2
- 212 Overdriven Guitar 2
- 213 Ukulele 2
- 214 Tango Accordion 2
- 215 Twin Trombones 2
- 216 Jazz Organ 2
- 217 Bright String 2
- 218 Reed Horn 2
- 219 Glockenspiel 2
- 220 Drawbar Organ 2
- 221 Muted Horn 2
- 222 Pizzicato Strings 2
- 223 Nay 2
- 224 Puff Harmonica 2
- 225 Muted Trumpet 2
- 226 Upright Piano 2
- 227 Soft Accord 2
- 228 Uilleann Harp 2
- 229 Tron Flute 2
- 230 Blown Bottle 2
- 231 Indian Flute 2
- 232 Slow Violin 2
- 233 Electric Guitar (Muted) 2
- 234 Multi Wind 2
- 235 Electric Vibraphone 2
- 236 Bodhran 2
- 237 Mellow Fm 2
- 238 Multi Reed 2
- 239 Contrabass 2
- 240 Barafon 2
- 241 Wind Organ 2
- 242 12-str. Guitar 2
- 243 Attack Barafon 2
- 244 Lead (Calliope)2
- 245 Viola Attack 2
- 246 Pad (Warm)2
- 247 Oct Harp 2
- 248 Bari & Tenor 2
- 249 Agogo 2
- 250 Flugel Horn 3
- 251 Organ Flute 3
- 252 Fiddle 3
- 253 Feedback Gt. 3
- 254 Chorus Guitar 3

RHYTHMS

- 000 Hard Rock
- 001 Club Pop
- 002 Fusion
- 003 Rap Pop
- 004 British Pop 1
- 005 Twist
- 006 8 Beat Pop 1
- 007 Fusion Shuffle
- 008 Funk
- 009 Funk Shuffle
- 010 Rock'n Roll 1
- 011 Rock Pop
- 012 Rock Shuffle
- 013 Rock Cha Cha
- 014 Straight Rock
- 015 Folk Rock
- 016 Pasodoble
- 017 Cha Cha
- 018 Fox Trot
- 019 Rumba 1
- 020 Samba 1
- 021 Samba 2
- 022 Schlager Rock
- 023 Tango 1
- 024 Tango 2
- 025 Disco Latin 1
- 026 Calypso
- 027 Latin Rock
- 028 Bolero
- 029 Analog Ballad 1
- 030 E-Ballad
- 031 Country Ballad
- 032 Electro Pop
- 033 Pop New Age 1
- 034 8 Beat Modern 1
- 035 R&B Ballad 1
- 036 Disco Fox 1
- 037 Disco Funk 1
- 038 Disco Party 1
- 039 Disco Samba 1
- 040 Disco Soul
- 041 Disco Trot
- 042 Rave 1
- 043 Funky Disco 1
- 044 Techno 1
- 045 Techno 2
- 046 Saturday Night 1
- 047 Club Latin 1

RHYTHMS

- 048 Disco Hands 1
- 049 Country
- 050 China 1
- 051 China 2
- 052 China 3
- 053 China 4
- 054 China 5
- 055 8 Beat Up Tempo
- 056 16 Beat Pop
- 057 16 Beat Shuffle
- 058 16 Beat Shuffle 2
- 059 16 Beat Ballad 1
- 060 16 Beat Ballad 2
- 061 Soul
- 062 Pop Rock 1
- 063 Pop Rock 2
- 064 8 Beat Rock Ballad
- 065 16 Beat Rock Ballad
- 066 6/8 Heavy Rock
- 067 16 Beat Rock
- 068 Bossa Nova 1
- 069 Bossa Nova 2
- 070 Salsa
- 071 Mambo
- 072 Beguine
- 073 Bolero Lento
- 074 Espagnole
- 075 Reggae 12
- 076 Pop Reggae 1
- 077 Slow Rock 1
- 078 Slow Rock 2
- 079 R&B
- 080 Dance Pop 1
- 081 Dance Pop 2
- 082 Euro Beat
- 083 Euro House
- 084 Hip Hop
- 085 Swing
- 086 Big Band Swing
- 087 Jazz Quartet
- 088 Dixieland
- 089 Bluegrass 1
- 090 Bluegrass 2
- 091 8 Beat Country
- 092 Country Rock
- 093 Country Ballad
- 094 March 1
- 095 March 2
- 096 Polka
- 097 Pop Waltz
- 098 Jive
- 099 Vienna Waltz
- 100 8 Beat Soul
- 101 Classical 8 Beat
- 102 Jazz Latin 1
- 103 Unplugged
- 104 Boogie
- 105 Cumbia 2
- 106 Classical Slow Rock
- 107 European Disco 1
- 108 Big Band Middle 1
- 109 Chrliston
- 110 Pasodobl
- 111 Cat Groove 1
- 112 Jazz Tango 1
- 113 Fast Gospel
- 114 Big Band Fast 1
- 115 Tricks Mambo
- 116 Funky Disco 2
- 117 Latin Salsa
- 118 Pop New Age 2
- 119 Jazz Swing 1
- 120 Trip Hop
- 121 Rave 2
- 122 Acoustic Ballad 1
- 123 India's Indigenious
- 124 Indonesian Pop
- 125 Pop Ballad
- 126 South Africa Country
- 127 South Africa Polka
- 128 Tarantella 1
- 129 Bright Pop
- 130 Pub Piano 1
- 131 West Shuffle
- 132 Big Band Fast 2
- 133 Espag Nol 1
- 134 Disco Funk 2
- 135 Pop Mambo
- 136 Europe Swing 1
- 137 Tricks Latin
- 138 Disco Samba 2
- 139 Latin Waltz
- 140 Dance Pop 3
- 141 Jazz Rock 1
- 142 Detroit
- 143 Fanatical Sand
- 144 European Rock 1
- 145 Ground Beat
- 146 8 Beat Modern 2
- 147 Jazz Disco 1
- 148 Dixie Jazz 1
- 149 Disco Chocolate
- 150 Disco Latin 2
- 151 Synth Boogie
- 152 Saturday Night 2
- 153 Club Dance 1
- 154 Tricks Bossa Nova
- 155 Tarantella 2
- 156 USA March
- 157 Espag Nol 2
- 158 Club Latin 2
- 159 Jazz Cha Cha 1
- 160 Country Cha Cha
- 161 Disco Party 2
- 162 Modern R&B 1
- 163 8 Beat Pop 2
- 164 Country Jazz

RHYTHMS

- 165 Soul Rock 1
- 166 Rumba 2
- 167 Samba 3
- 168 Modern R&B 2
- 169 Club Dance 2
- 170 Country Bossa Nova
- 171 Jazz Bo 1
- 172 Modern Cha Cha 1
- 173 Pop Reggae 2
- 174 Rock Samba 1
- 175 Jazz 8 Beat 1
- 176 Disco
- 177 Seville 1
- 178 Disco Hands 2
- 179 Rock Ballad
- 180 Mixed Bossa Nova
- 181 Jazz 16 Beat 1
- 182 Single 16 Beat 1
- 183 Love Song
- 184 Single 16 Beat 2
- 185 Disco Fox 2
- 186 Pop Rock 3
- 187 Tijuana Waltz
- 188 British Pop 2
- 189 Show Tune 1
- 190 Schlager Alp
- 191 Single Rock
- 192 Swing Waltz
- 193 Slow Waltz
- 194 Cat Groove 2
- 195 Country Slow Rock
- 196 Rock Disco 1
- 197 16 Beat Shuffle 1
- 198 Jazz 8 Beat 2
- 199 Casa
- 200 Guad Dance 1
- 201 Jazz Cha Cha 2
- 202 Country Waltz
- 203 European Rock 2
- 204 Caribbean Dance 2
- 205 Jazz Disco 2
- 206 Medium Jazz
- 207 Piano Ballad
- 208 70's Disco
- 209 Jazz Rock 2
- 210 Europe 8 Beat 1
- 211 Seville 2
- 212 Rumba 3
- 213 Soul Rock 2
- 214 European Disco 2
- 215 Analog Ballad 2
- 216 Pub Piano 2
- 217 Europe Rumba
- 218 Rock'n Roll 2
- 219 Disco Trop
- 220 Rock Salsa 1
- 221 Europe 8 Beat 2
- 222 Europe Samba
- 223 Show Tune 2
- 224 Jazz 16 Beat 2
- 225 Rock Samba 2
- 226 Jazz Waltz 2
- 227 Europe Reggae
- 228 Modern Cha Cha 2
- 229 R&B Ballad 2
- 230 Rock Boogie
- 231 Jazz Bossa Nova
- 232 Rock Salsa 2
- 233 Slow & Easy
- 234 Hip Waltz 1
- 235 Jazz Latin 2
- 236 Rock Disco 2
- 237 Jazz Tango 2
- 238 Analog Ballad 3
- 239 Europe Swing 2
- 240 Hip Waltz 2
- 241 Jazz Swing 2
- 242 Party Pop
- 243 Jazz Club
- 244 Guad Dance 2
- 245 Jazz Bo 2
- 246 Dixie Jazz 2
- 247 Acoustic Ballad 2
- 248 Jazz Slow Rock
- 249 16 Beat Shuffle 2
- 250 Polka Pop
- 251 Latin Party Pop
- 252 Parranda
- 253 Carnival
- 254 60's Vintage Pop

DEMONSTRATION SONG LIST

- D00** Fur Elise
- D01** Clarinet Polka
- D02** The Magic Flute Overture
- D03** Johan Sebastian Bach
- D04** American Patrol
- D05** Radetzky March
- D06** Cowboy
- D07** Mozart #40
- D08** Swan Lake
- D09** Old Macdonald Had a Farm
- D10** Old French Air
- D11** Twinkle Twinkle Little Star
- D12** Cuckoo Waltz
- D13** Red River Valley
- D14** March (The Nutcracker)
- D15** Moscow at Night
- D16** Ode to Joy
- D17** What a Wonderful World
- D18** Polonaise
- D19** Song of the Seashore
- D20** Symphony of Carmen
- D21** Mary Had a Little Lamb
- D22** She Wore a Yellow Ribbon
- D23** Danny Boy
- D24** Schubert Serenade
- D25** Minuet (L'Arlesienne)
- D26** Ding Dong Merrily on High
- D27** Beethoven's Sonata
- D28** Camptown Races
- D29** Moonlight
- D30** Flower Dance
- D31** Nocturne op.9 no.2
- D32** Green Sleeves
- D33** Beijing Welcomes You
- D34** Little Apple
- D35** Happy Home
- D36** Wander
- D37** Nanniwan
- D38** Prairie Song
- D39** Aobaoshan
- D40** Liuyang River
- D41** The Bending Moon
- D42** Came with Every
- D43** My Little Baby
- D44** Pink Memories
- D45** Stepping Higher and Higher
- D46** Cloud to Chase the Moon
- D47** Jaunty
- D48** You Set Off to the Chapeau
- D49** The Qinghai-Tibet Plateau

WARNING

- Only use the provided power adapter. Do not use damaged adapters.
- Do not disassemble the instrument or modify internal parts. If it malfunctions, discontinue use until repairs have been made.
- Turn off power before connecting this instrument to other devices.
- Do not play the instrument at maximum volume or at an uncomfortable level for an extended period of time.
- Be aware that excessive sound pressure from headphones can cause hearing loss.
- Overheating the instrument may cause damage; keep all parts of the instrument off heat sources.
- Prevent liquid, dust, particles, and other foreign matter from entering the instrument because it may cause corrosion or short-circuit the components.
- Unplug the instrument before cleaning it. Do not insert or pull the plug out with wet hands.
- Use dry, soft cloth to clean the instrument. Do not use alcohol or other chemical solvents to wipe the instrument. Using these substances may damage the instrument surface.
- Turn off the power supply and unplug the instrument when not in use or if instrument breaks.
- To reduce risk of fire or electric shock, do not expose instrument to rain or humidity.
- Do not expose instrument to dripping or splashing liquid. Do not place objects filled with liquid on the instrument.
- Do not install this instrument in a confined space such as a book case or similar unit. Keep instrument in a well-ventilated area.
- To prevent possible harm to the environment, recycle this responsibly to promote the sustainable reuse of material resources.

FCC COMPLIANCE STATEMENT

This device complies with part 15 of the FCC rules. Operation is subject to the following two conditions: (1) This product may not cause harmful interference, and (2) this device must accept any interference received, including interference that may cause undesired operation.

NOTE: This equipment has been tested and found to comply with the limits for a Class B digital device, pursuant to part 15 of the FCC Rules. These limits are designed to provide reasonable protection against harmful interference in a residential installation.

This equipment generates, uses, and can radiate radio frequency energy and, if not installed and used in accordance with the instructions, may cause harmful interference to radio communications. However, there is no guarantee that interference will not occur in a particular installation.

If this equipment does cause harmful interference to radio or television reception, which can be determined by turning the equipment off and on, the user is encouraged to try to correct the interference by one or more of the following measures:

- Reorient or relocate the receiving antenna.
- Increase the separation between the equipment and receiver.
- Connect the equipment to an outlet on a circuit different from that to which the receiver is connected.
- Consult the dealer or an experienced radio/TV technician for help.

WARNING: Any changes or modifications to this unit not expressly approved by the party responsible for compliance could void the user's authority to operate the equipment.

Responsible party (contact for FCC matters only):

Quality Control Dept.
15101 Red Hill Ave.
Tustin, CA 92780



HELP CENTER



Question about your product? We're here to help. Visit us at:

help.bestchoiceproducts.com



Chat Support



Product Inquiry



Orders FAQ



Product Assembly



Returns & Refunds

PRODUCT WARRANTY INFORMATION

All items can be returned for any reason within 60 days of the receipt and will receive a full refund as long as the item is returned in its original product packaging and all accessories from its original shipment are included. All returned items will receive a full refund back to the original payment method. All returned items will not be charged a re-stocking fee.

All returned items require an RA (Return Authorization) number, which can only be provided by a Best Choice Products Customer Service Representative when the return request is submitted. Items received without an RA may not be accepted or may increase your return processing time. Once an item has been received by Best Choice Products, refunds or replacements will be processed within 5 business days.

All returns must be shipped back to the Best Choice Products Return Center at the customer's expense. If the reason for return is a result of an error by Best Choice Products then Best Choice Products will provide a pre-paid shipping label via email. Boxes for return shipping will not be provided by Best Choice Products, and is the customer's responsibility to either use the original shipping boxes or purchase new boxes.

Pictures may be required for some returns to ensure an item is not damaged prior to its return. Items returned are not considered undamaged until they are received by Best Choice Products and verified as such. All damages to items are the customer's responsibility until the item has been received by and acknowledge by Best Choice Products as undamaged.

WARNING

Manufacturer and seller expressly disclaim any and all liability for personal injury, property damage or loss, whether direct, indirect, or incidental, resulting from the incorrect attachment, improper use, inadequate maintenance, unapproved modification, or neglect of this product.