

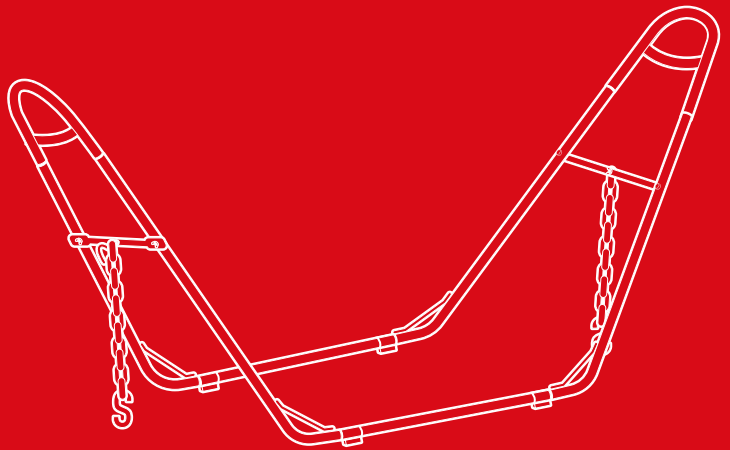

bestchoiceproducts



# INSTRUCTION MANUAL

---

Adjustable Hammock Stand



**bestchoice**products

---

Thank you for choosing us! Since 2002, Best Choice Products has been bringing customers high-quality products at the absolute lowest price. With everything ranging from instruments and toys to furniture and outdoor, we've got your everyday living essentials covered. We're centered around a customer-first philosophy - with free shipping, exceptional customer service, and a catalog sourced with you in mind.

---

## ! NOTICE

- This item is only the hammock stand; the hammock is sold separately.
- Hammock stand accommodates **9- to 14-foot hammocks**.
- Please do not exceed the weight limitations of this item.
- Do not stand on or use any part of this product as a step ladder.
- Firmly secure all bolts, screws and knobs before use.
- Reconfirm that all bolts, screws, and knobs are secure every 90 days.
- Be aware that some parts are heavy and have sharp edges.
- If any parts are missing, broken, damaged, or worn, stop using this product until repairs are made and/or factory replacement parts are installed.
- Do not use this item in a way inconsistent with the manufacturer's instructions as this could void the product warranty.



440 LBS  
CAPACITY



1 PERSON  
ASSEMBLY



APPROXIMATELY  
20 MIN.  
ASSEMBLY

## HARDWARE

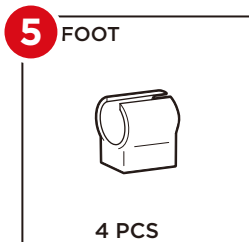
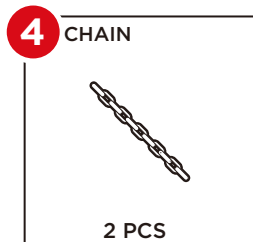
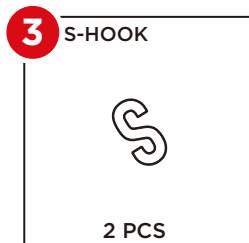
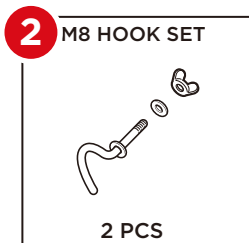
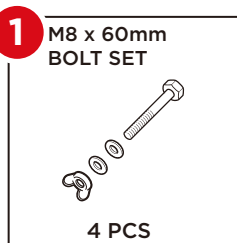

## PARTS

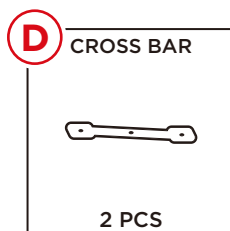
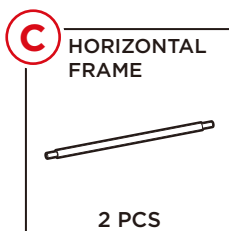
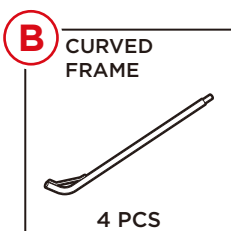
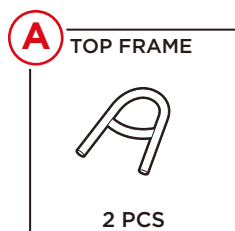

## PRODUCT ASSEMBLY

Please retain these instructions for future reference.

# 1

Assemble the hammock stand.

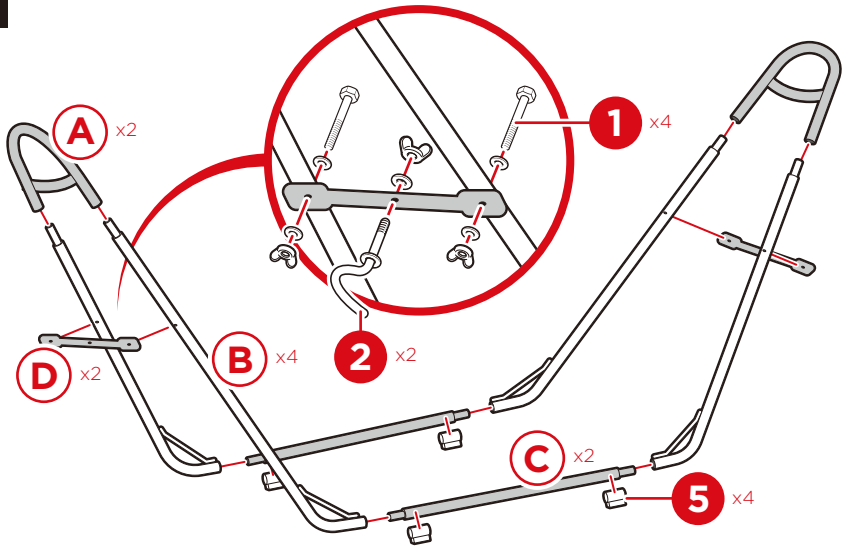

# 2

Hang two part 3 s-hooks from two part 4 chains. Hang the chains from the part 2 hooks on the hammock stand.

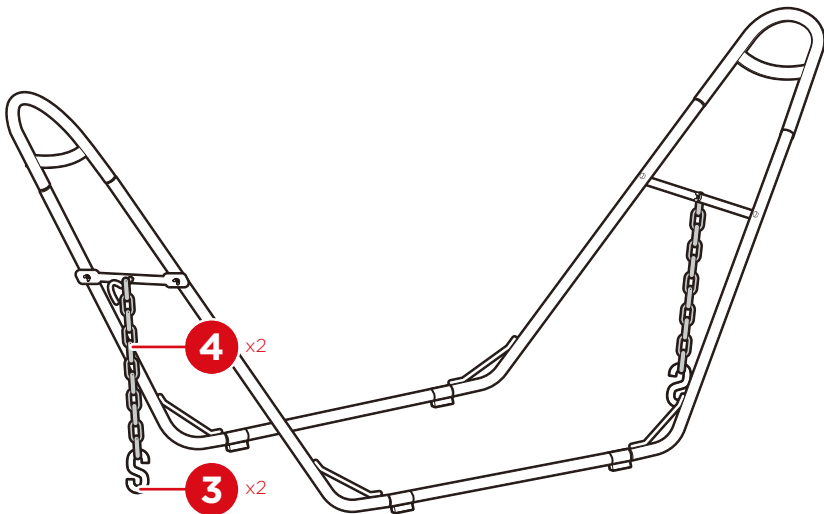

## PRODUCT ASSEMBLY

3

Hook a hammock (**not included**) onto the s-hooks. Adjust the length of the chains to tighten/loosen the fit.

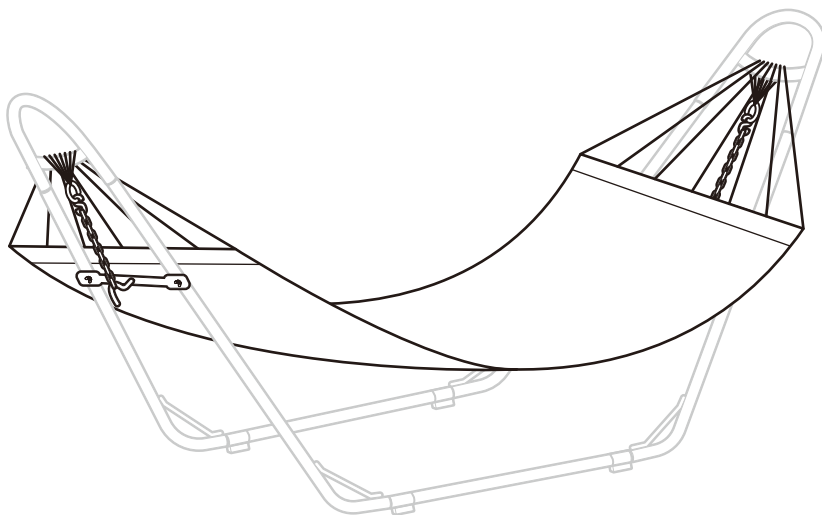

## ALTERNATIVE SET-UP

Hook two part 3 s-hooks onto the ends of a hammock (**not included**). Hang the hammock from the s-hooks.

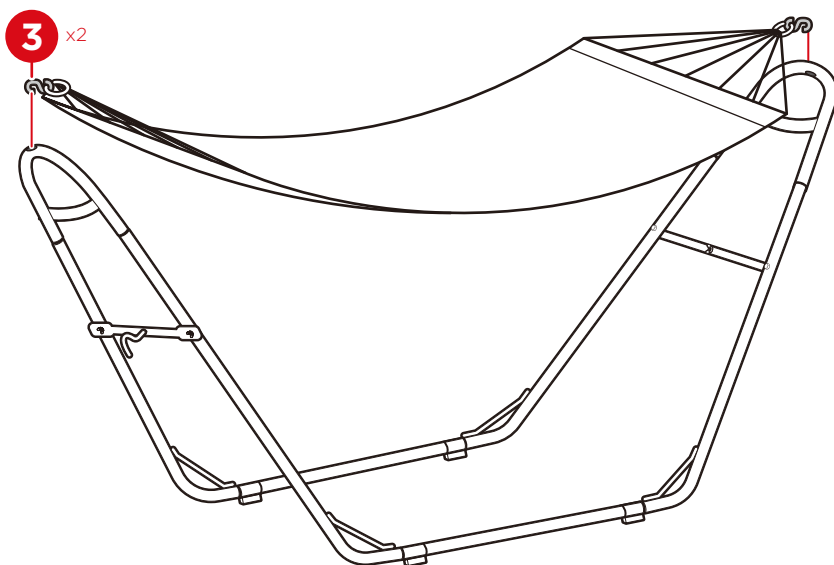

Earn points while you shop. Join today!

bestchoiceproducts  
**rewards**

Join | Earn | Redeem

Give your friends 15% off their first order! For each successful referral you'll receive 100 points.

[bestchoiceproducts.com](https://bestchoiceproducts.com)



**bestchoice**products

---

Check out more great products:  
**[bestchoiceproducts.com](https://www.bestchoiceproducts.com)**

---



# HELP CENTER



Question about your product? We're here to help. Visit us at:

[help.bestchoiceproducts.com](http://help.bestchoiceproducts.com)



Chat Support



Product Inquiry



Orders FAQ



Product Assembly



Returns & Refunds

## PRODUCT WARRANTY INFORMATION

All items can be returned for any reason within 60 days of the receipt and will receive a full refund as long as the item is returned in its original product packaging and all accessories from its original shipment are included. All returned items will receive a full refund back to the original payment method. All returned items will not be charged a re-stocking fee.

All returned items require an RA (Return Authorization) number, which can only be provided by a Best Choice Products Customer Service Representative when the return request is submitted. Items received without an RA may not be accepted or may increase your return processing time. Once an item has been received by Best Choice Products, refunds or replacements will be processed within 5 business days.

All returns must be shipped back to the Best Choice Products Return Center at the customer's expense. If the reason for return is a result of an error by Best Choice Products then Best Choice Products will provide a pre-paid shipping label via email. Boxes for return shipping will not be provided by Best Choice Products, and is the customer's responsibility to either use the original shipping boxes or purchase new boxes.

Pictures may be required for some returns to ensure an item is not damaged prior to its return. Items returned are not considered undamaged until they are received by Best Choice Products and verified as such. All damages to items are the customer's responsibility until the item has been received by and acknowledge by Best Choice Products as undamaged.



## WARNING

Manufacturer and seller expressly disclaim any and all liability for personal injury, property damage or loss, whether direct, indirect, or incidental, resulting from the incorrect attachment, improper use, inadequate maintenance, or neglect of this product.