

Kräus®

www.kraususa.com

**Model No.
KGD-433B (Undermount)**

Pro Hotline: 516.801.8955

Customer Service: 800.775.0703

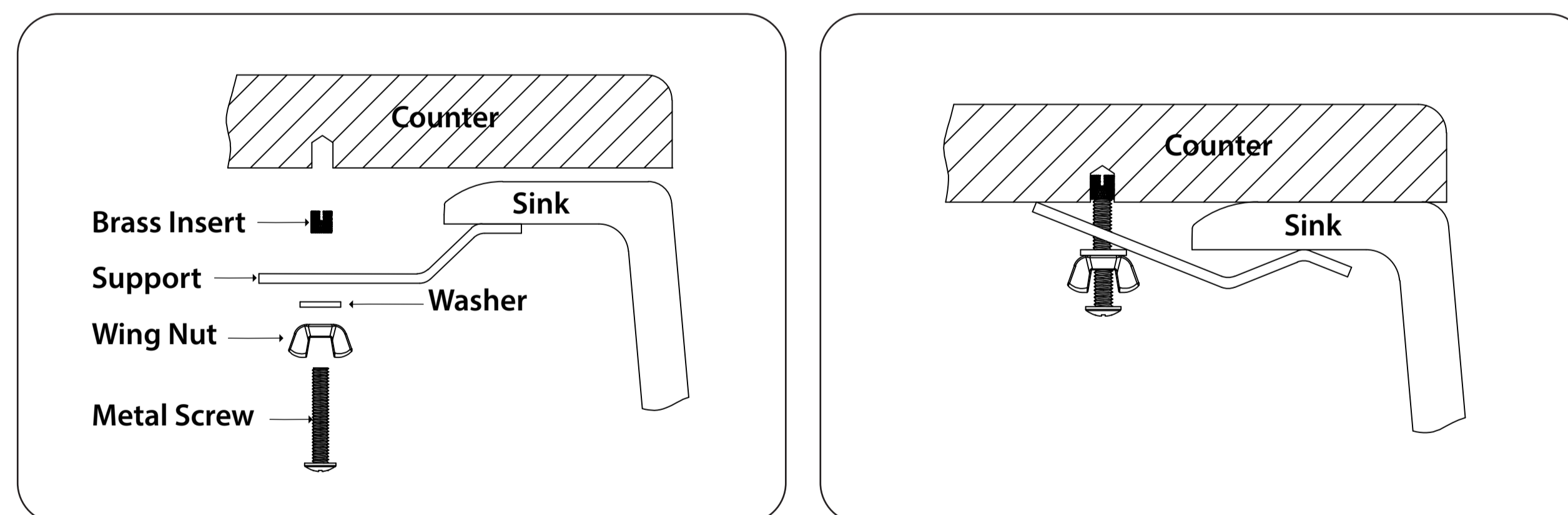
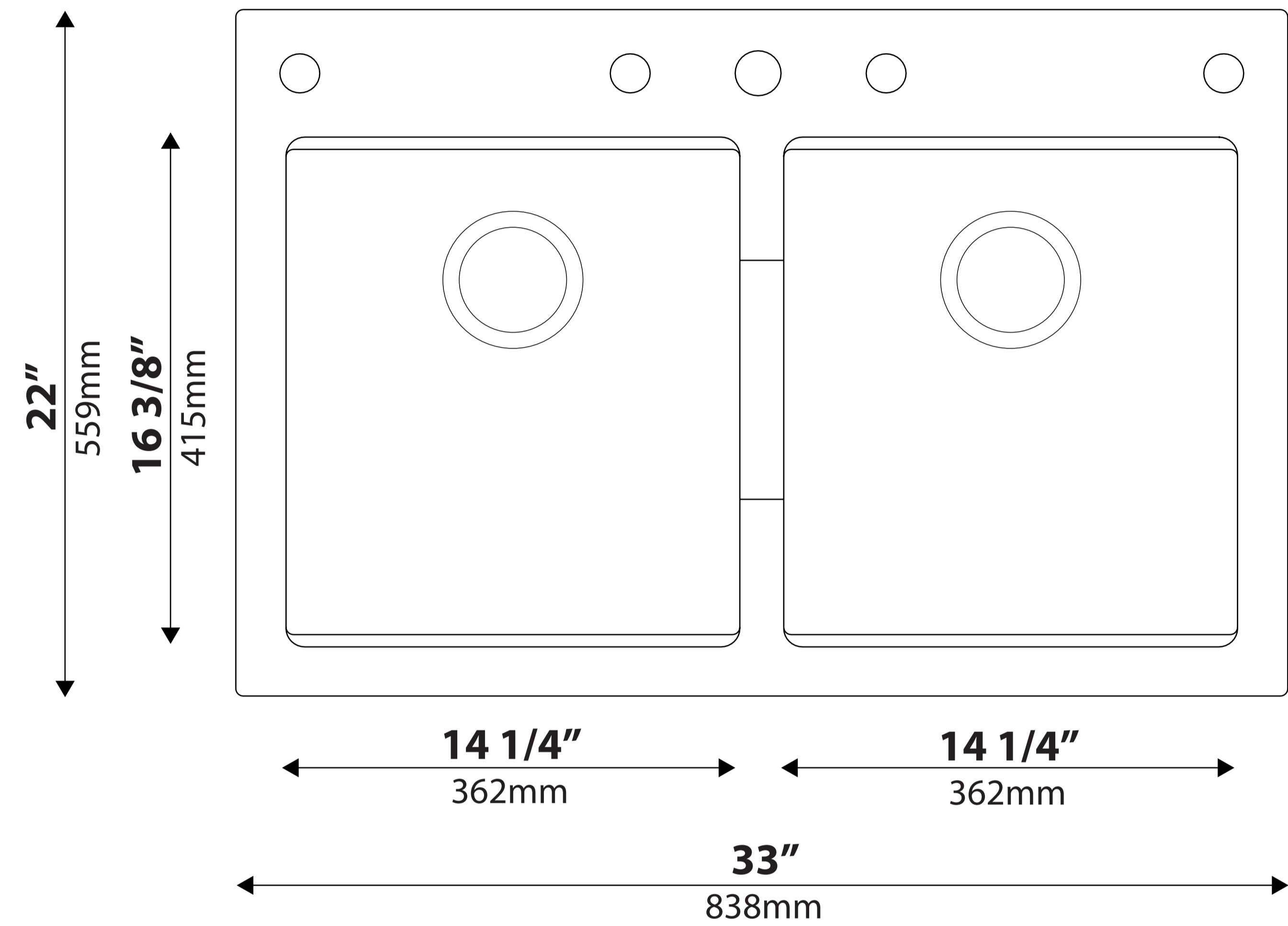

NOTE: Cutout template is provided as a guide **ONLY** and must be checked against actual sink to verify correct fit.