

# 2304123B ZALIE GREENHOUSE Container Loading Diagram

( 1 set=8 boxes 35 sets/40HQ, 20 pallets/ 40HQ, Gross Weight: 14930kg)

Top view

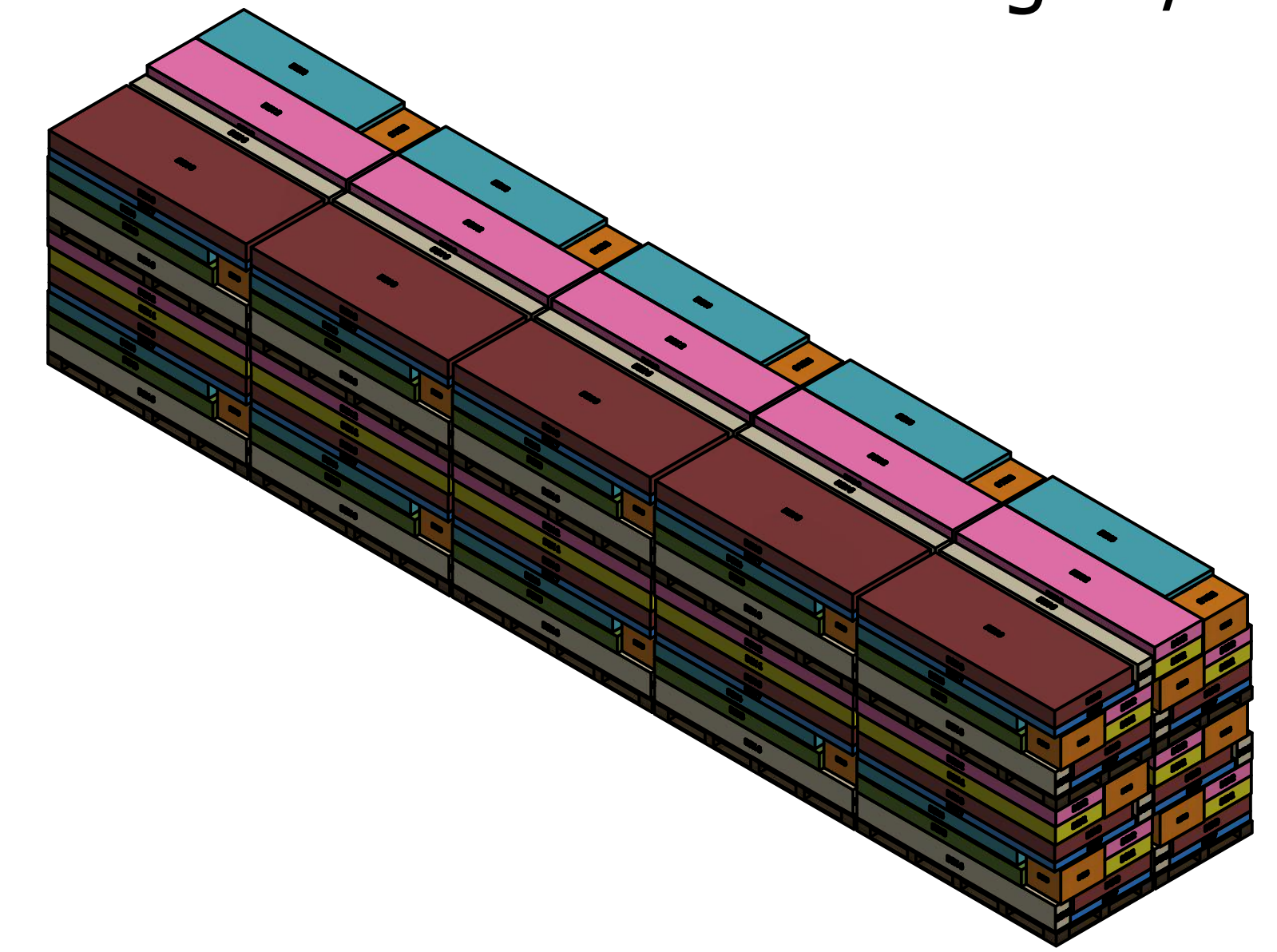
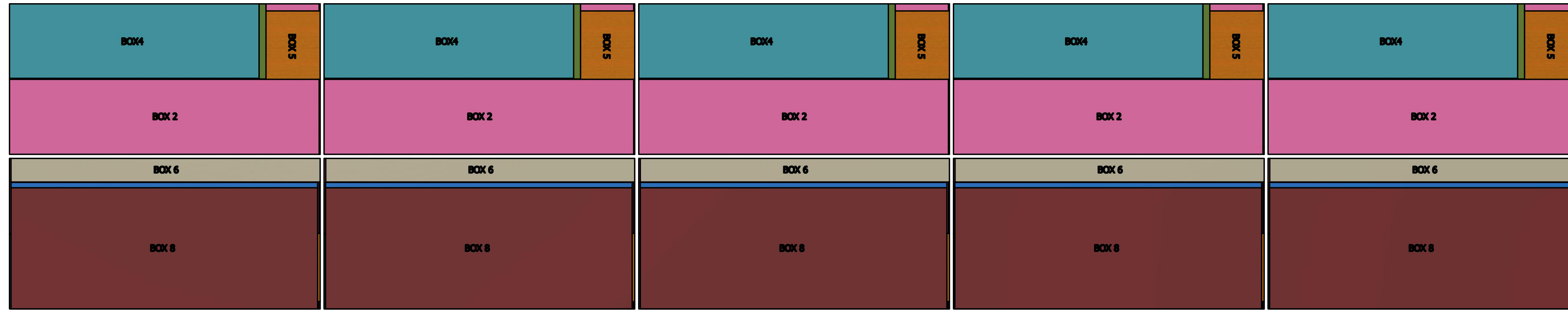

Side view

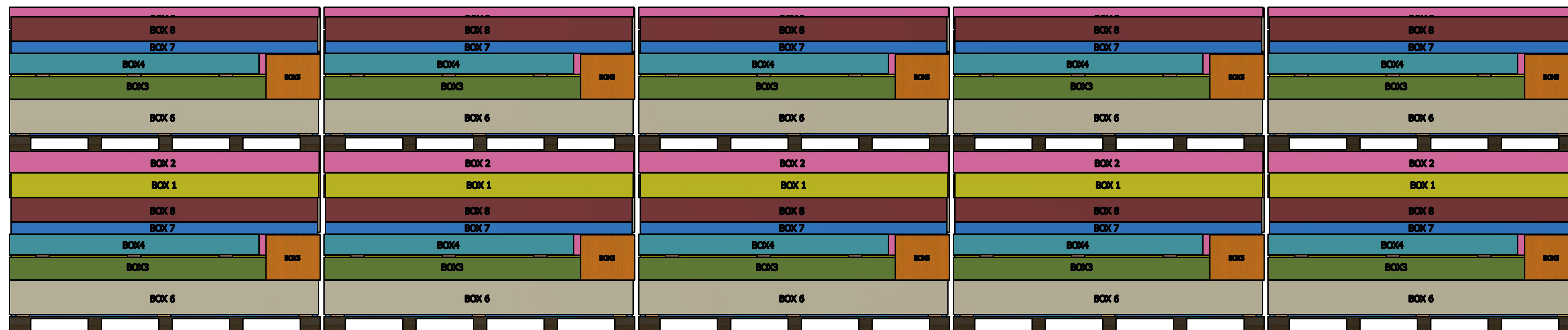

End view

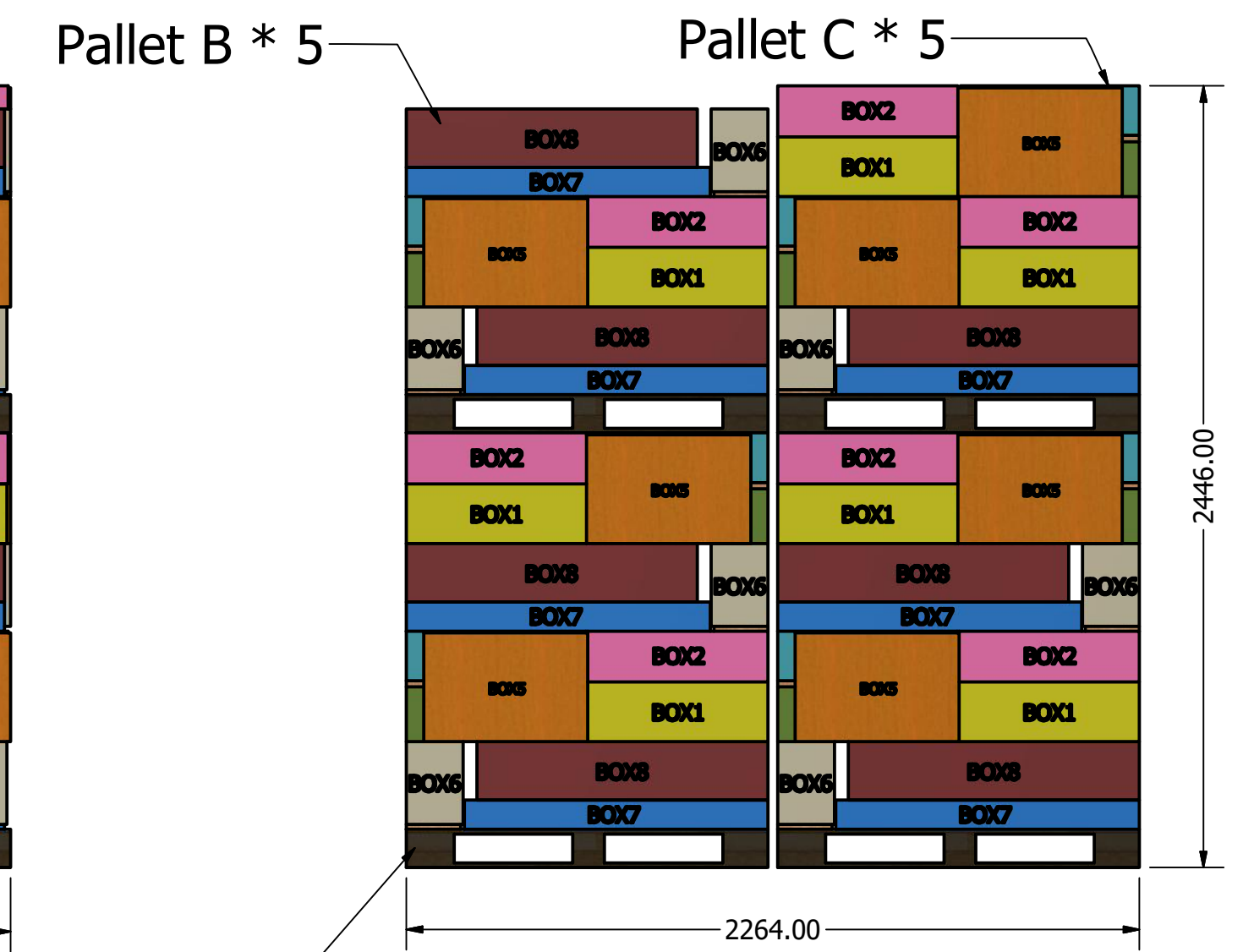

Pallet A \* 10

11690.00

2264.00

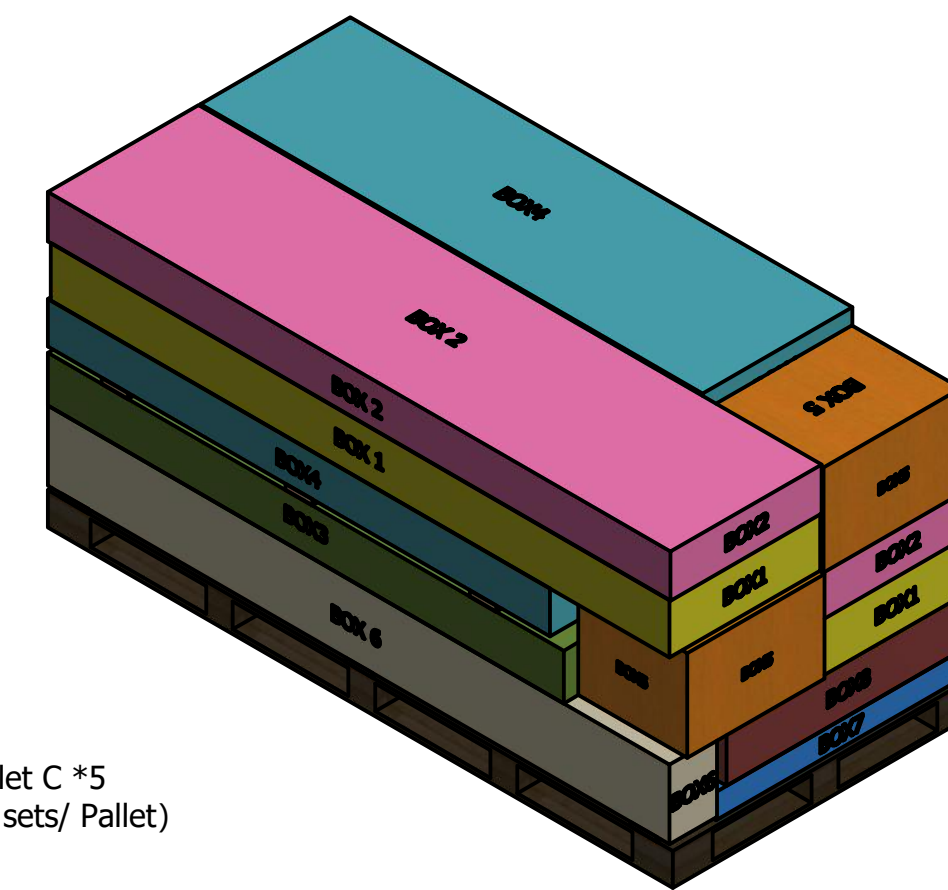
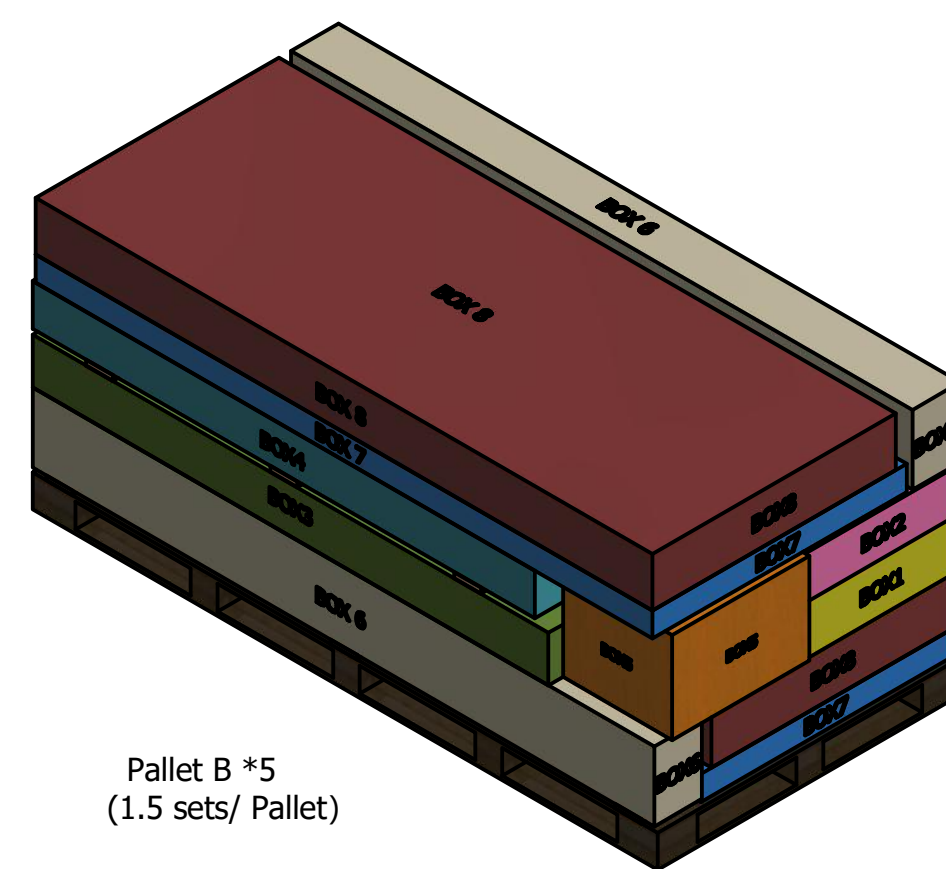
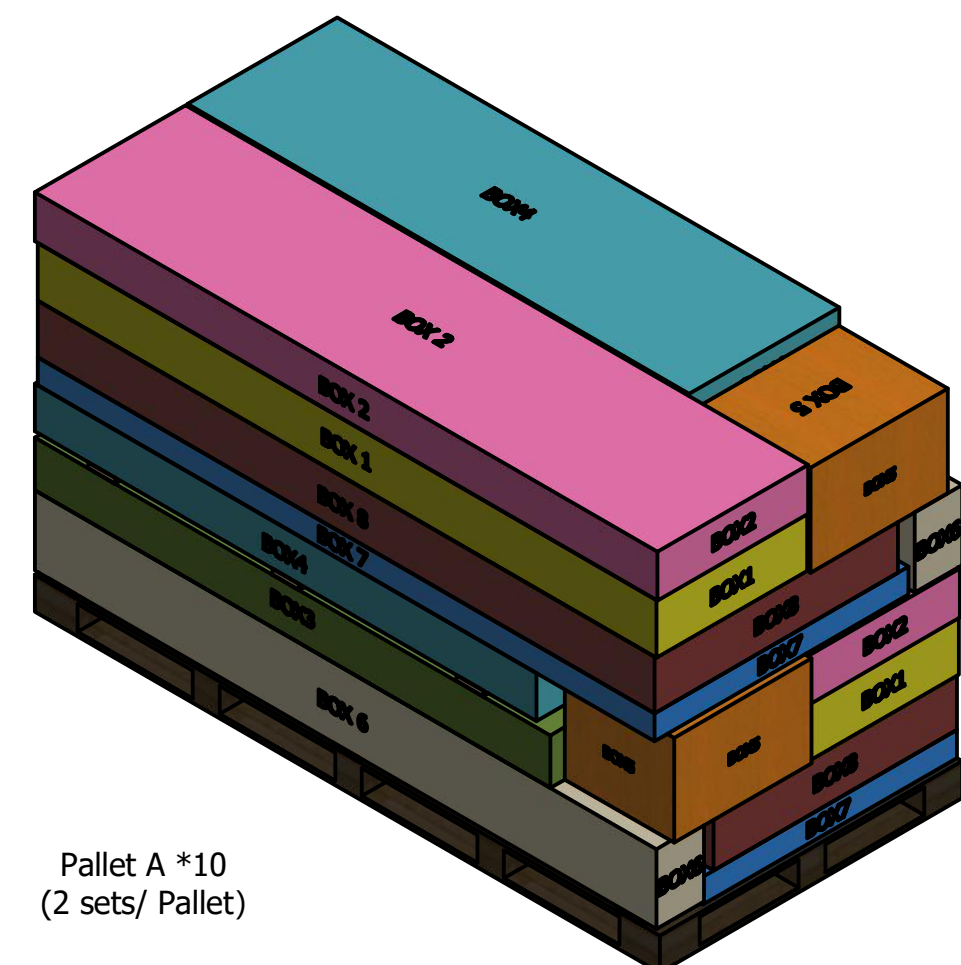

DRAWN	Rudy	2019/8/19		
CHECKED			TITLE	
QA				
MFG				
APPROVED				
			SIZE	DWG NO
			D	2006522
			SCALE	1 / 20
			SHEET 1 OF 1	

Pallet A ( 2 sets/pallet )

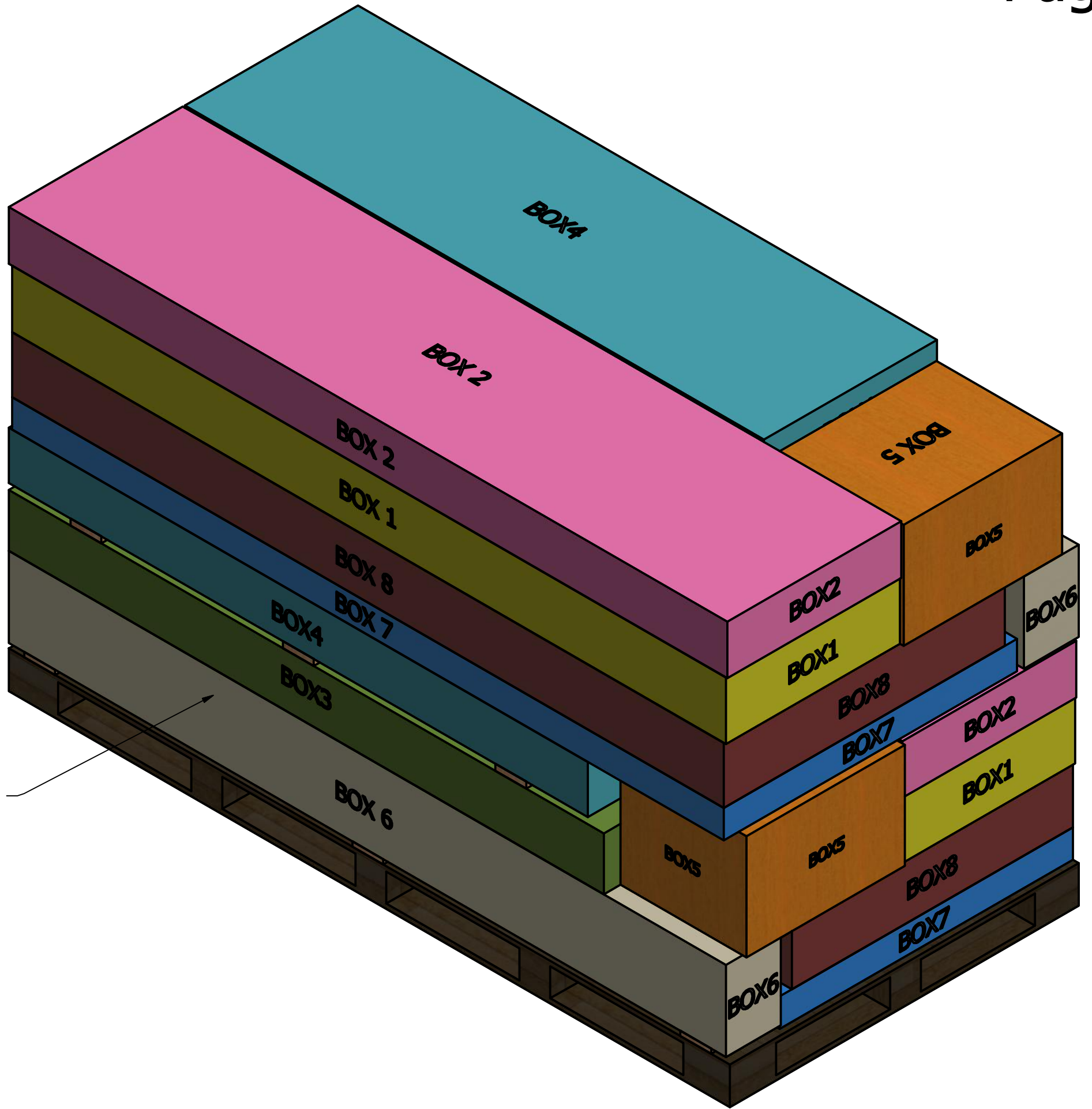

Banded bottom 1 unit at first,  
and then banded entire pallet ;  
叠好底下1整套后, 用2根塑钢带进行捆绑;  
叠好整托后, 再用另外3根塑钢带进行捆绑;

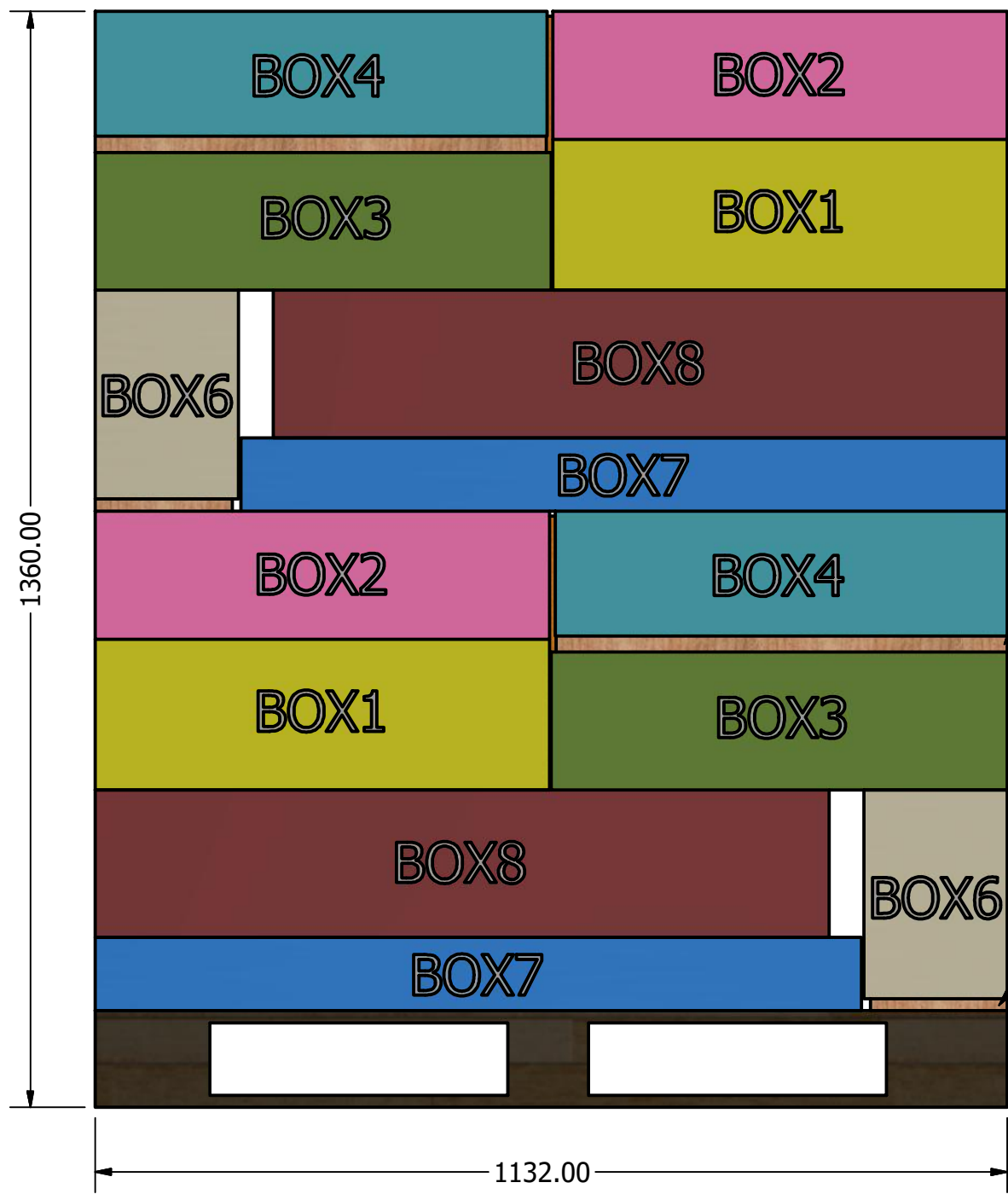
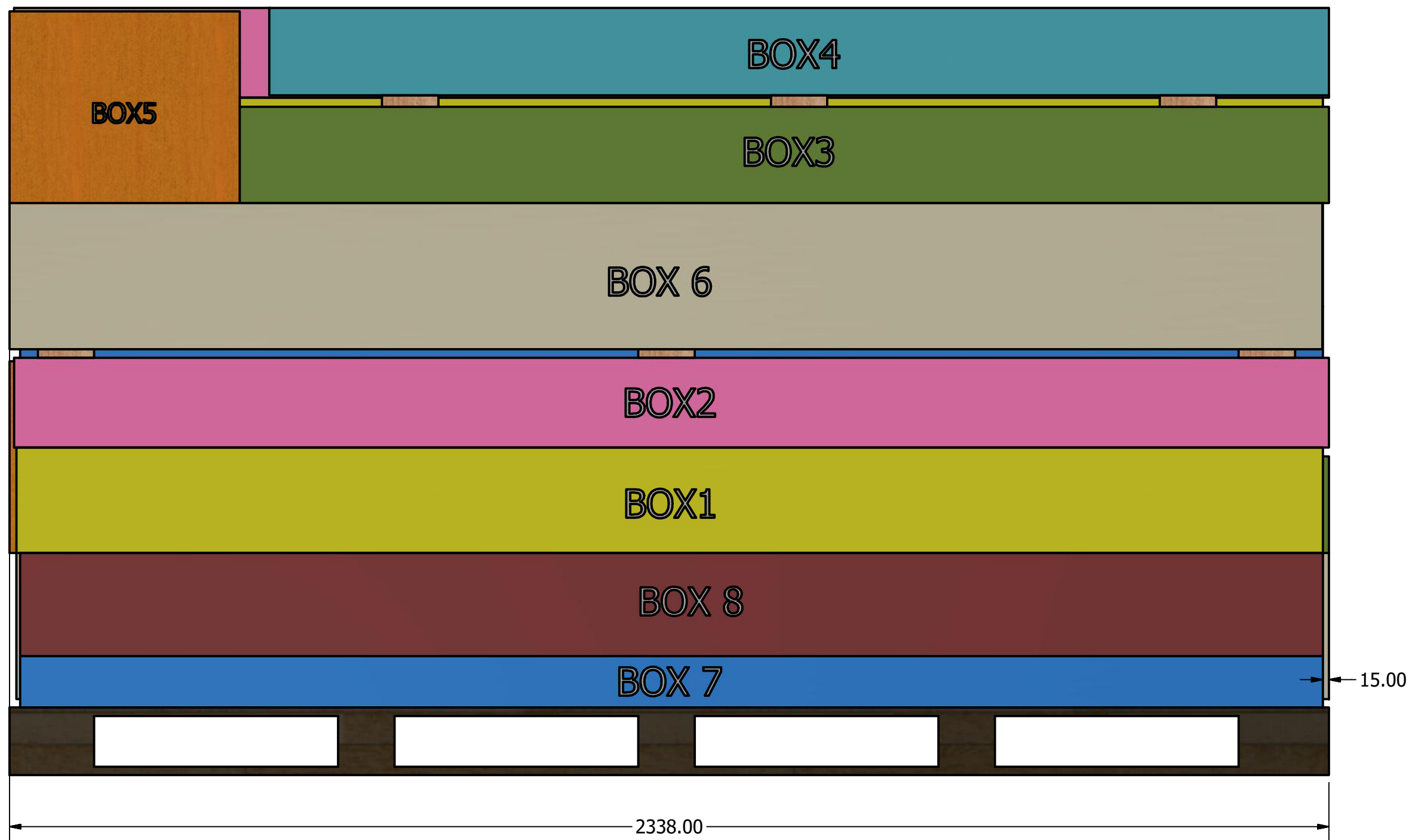

Plywood block 560mm\*100mm\*20mm (3pcs/set)  
胶合板垫款 560mm\*100mm\*20mm (3片/套)

Plywood block 170mm\*100mm\*8mm (3pcs/set)  
胶合板垫款 170mm\*100mm\*8mm (3片/套)

DRAWN		TITLE		
CHECKED		TITLE		
QA		TITLE		
MFG		TITLE		
APPROVED		TITLE		
		SIZE	DWG NO	REV
		D		
		SCALE	SHEET 1 OF 1	
		1 : 10		

Pallet B ( 1.5 sets/pallet )

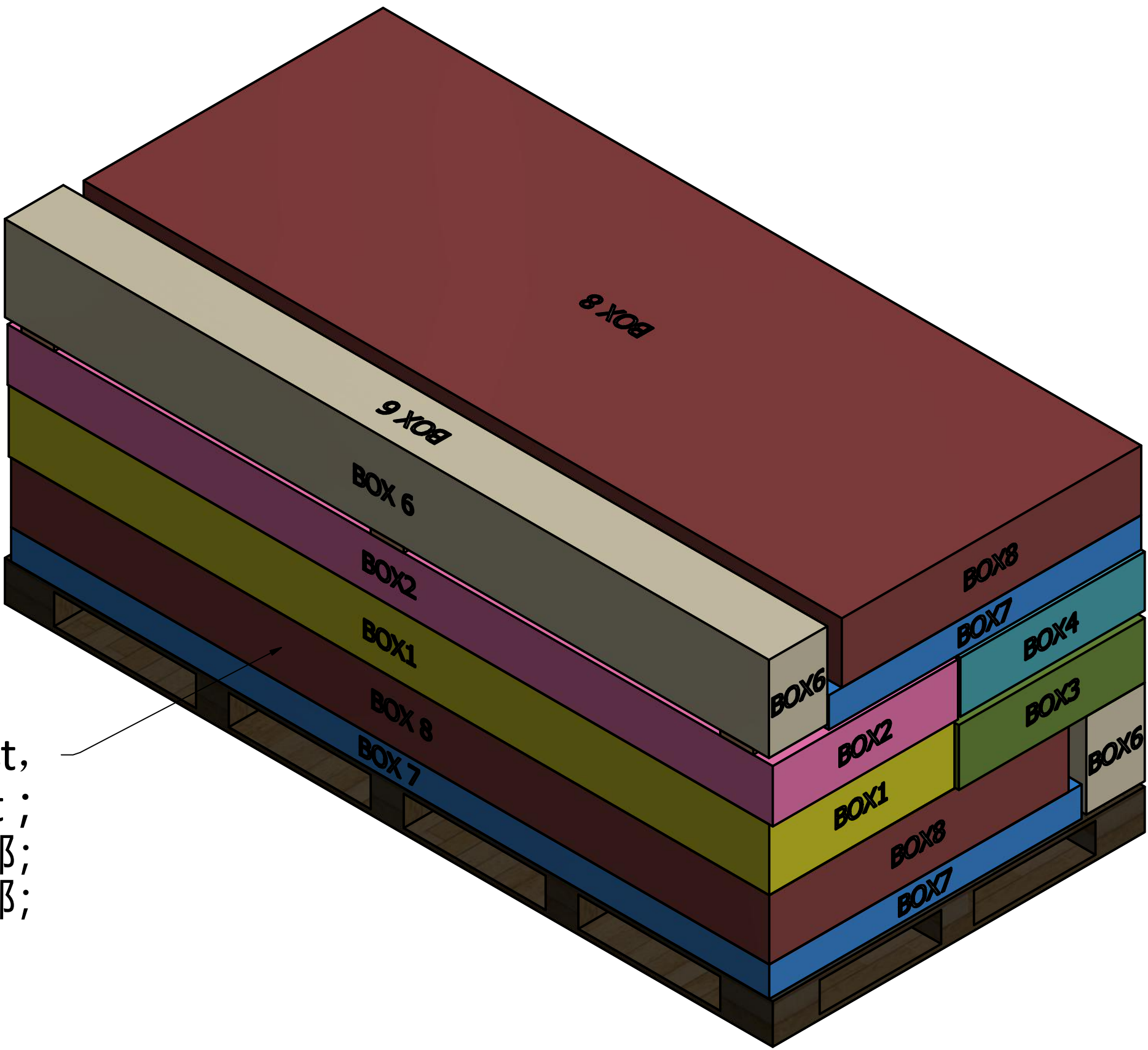

Banded bottom 1 unit at first,  
and then banded entire pallet ;  
叠好底下1整套后, 用2根塑钢带进行捆绑;  
叠好整托后, 再用另外3根塑钢带进行捆绑;

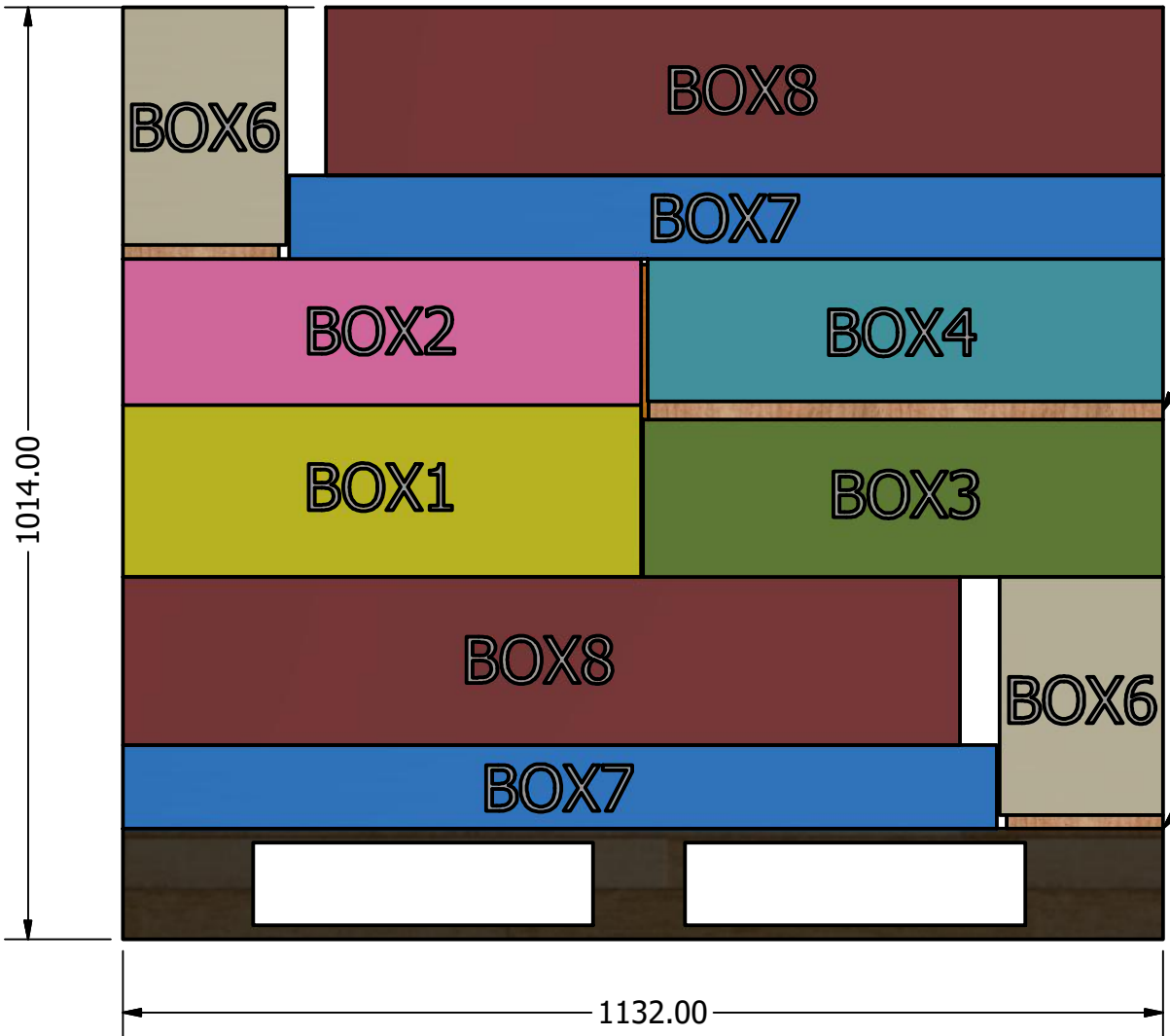
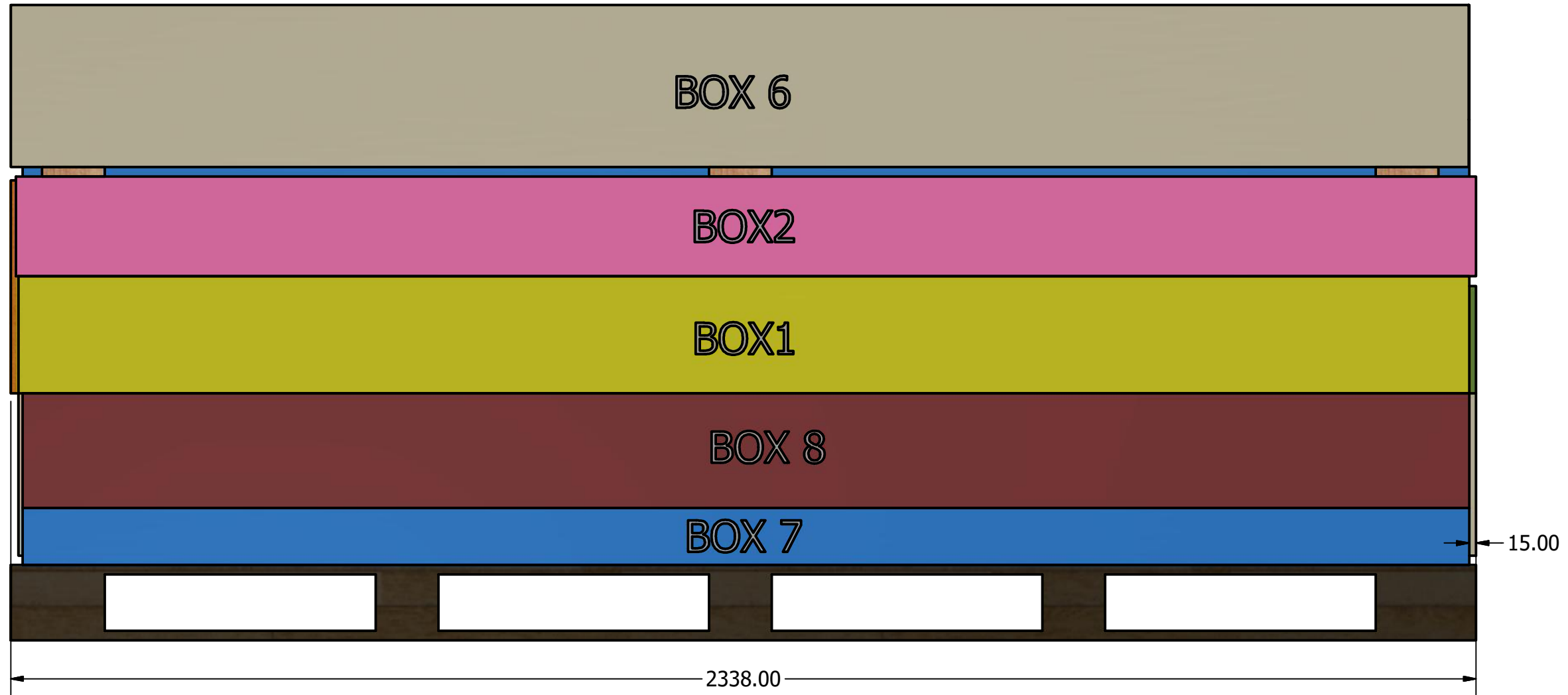

Plywood block 560mm\*100mm\*20mm (3pcs/set)  
胶合板垫款 560mm\*100mm\*20mm (3片/套)

Plywood block 170mm\*100mm\*8mm (3pcs/set)  
胶合板垫款 170mm\*100mm\*8mm (3片/套)

DRAWN		TITLE		
CHECKED				
QA				
MFG				
APPROVED				
		SIZE	DWG NO	REV
		D		
		SCALE	1: 8	
		SHEET 1 OF 1		

Pallet C ( 1.5 sets/pallet )

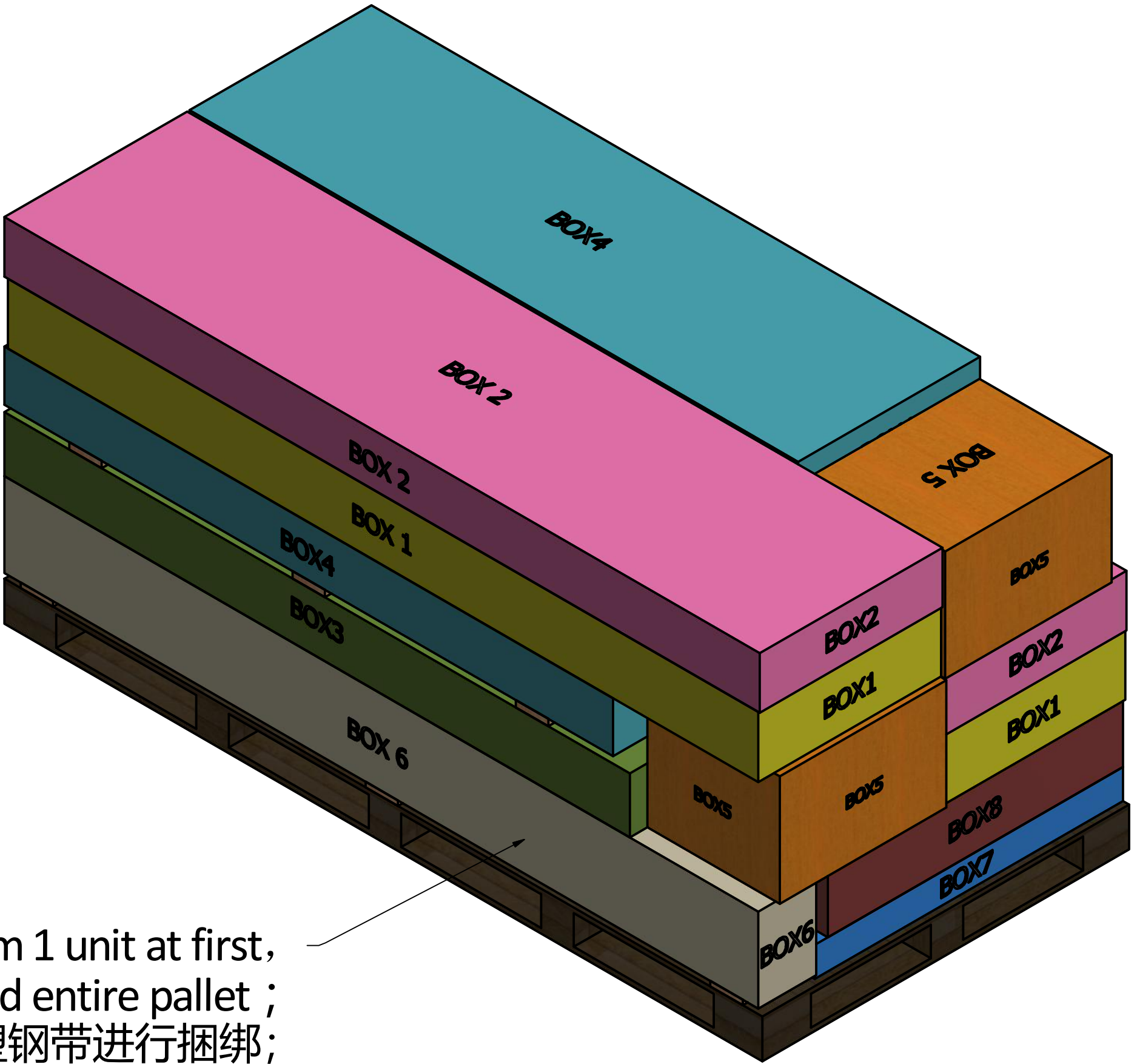
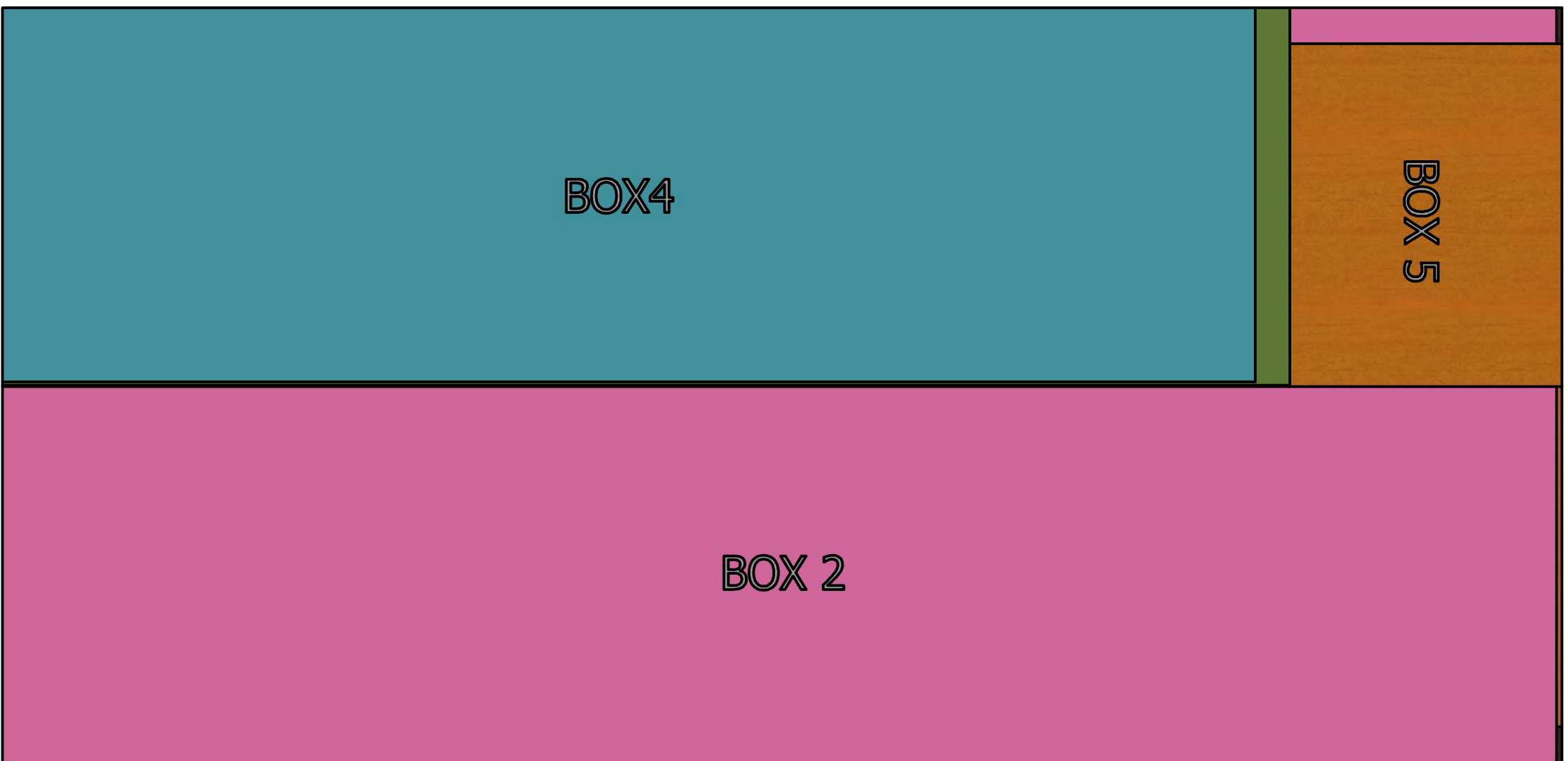

Banded bottom 1 unit at first,  
and then banded entire pallet ;  
叠好底下1整套后, 用2根塑钢带进行捆绑;  
叠好整托后, 再用另外3根塑钢带进行捆绑;

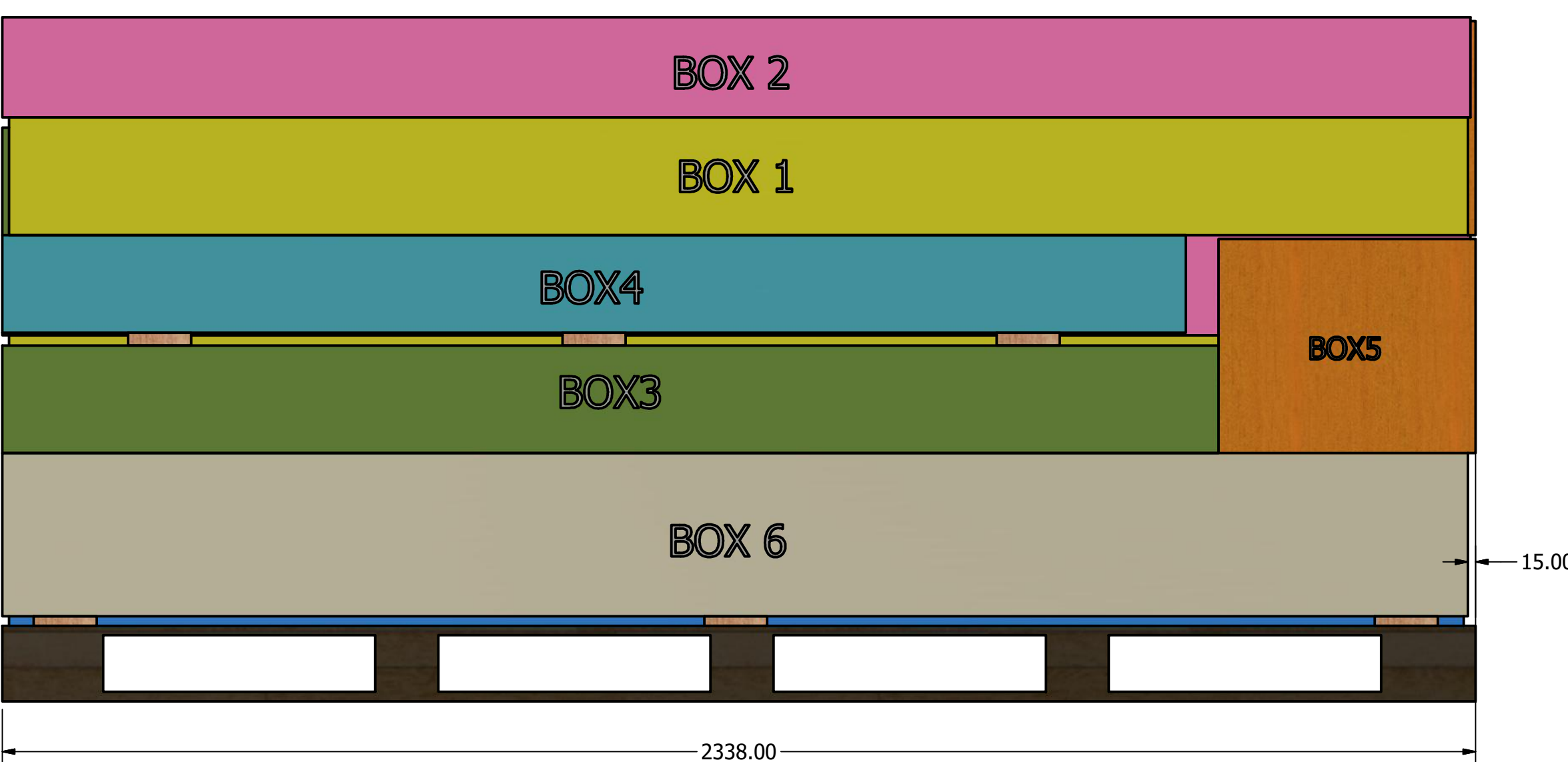

Plywood block 560mm\*100mm\*20mm (3pcs/set)  
胶合板垫款 560mm\*100mm\*20mm (3片/套)

Plywood block 170mm\*100mm\*8mm (3pcs/set)  
胶合板垫款 170mm\*100mm\*8mm (3片/套)

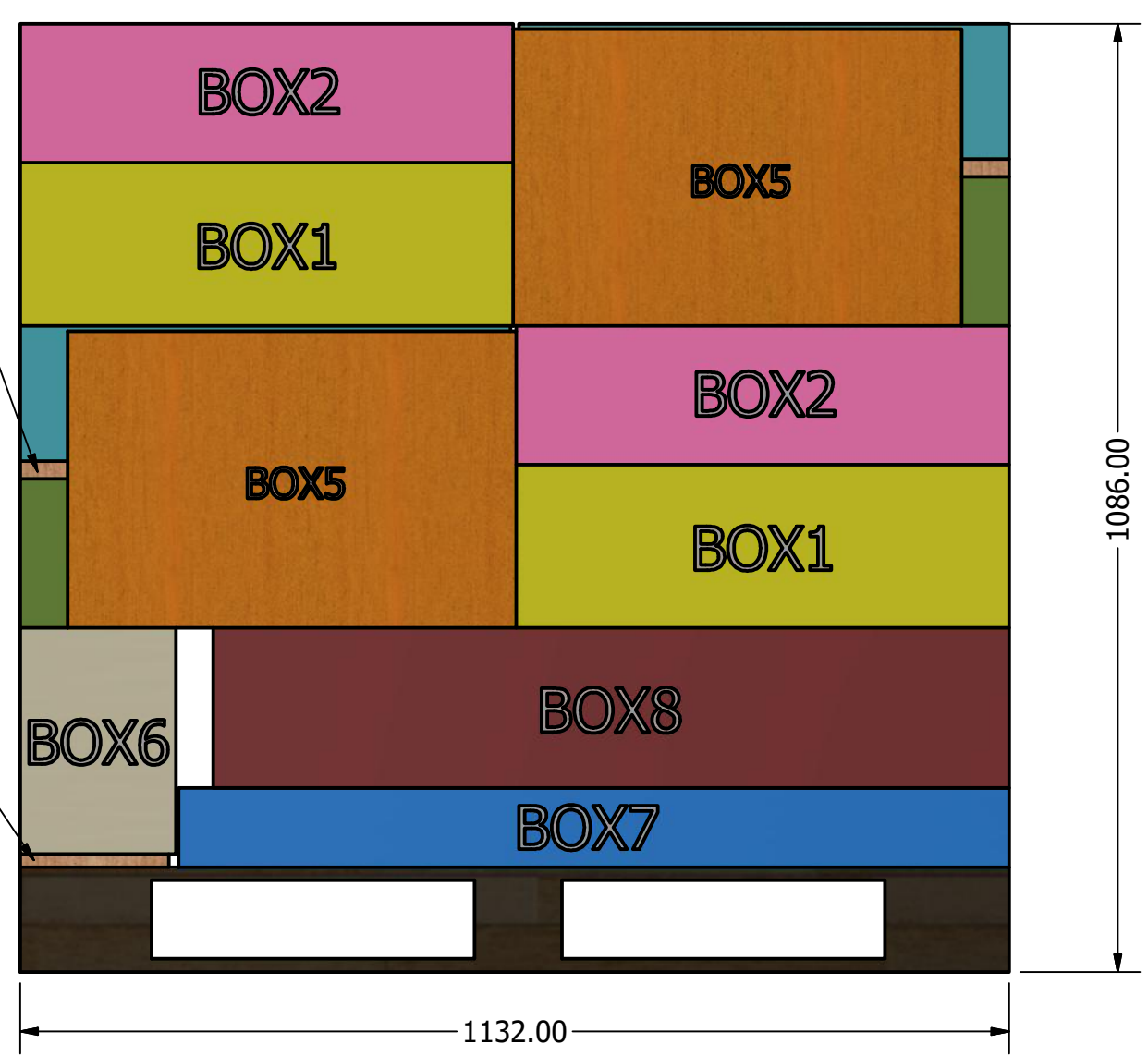

DRAWN		TITLE		
CHECKED				
QA				
MFG				
APPROVED				
		SIZE	DWG NO	REV
		D		
		SCALE	SHEET 1 OF 1	
		1: 8		

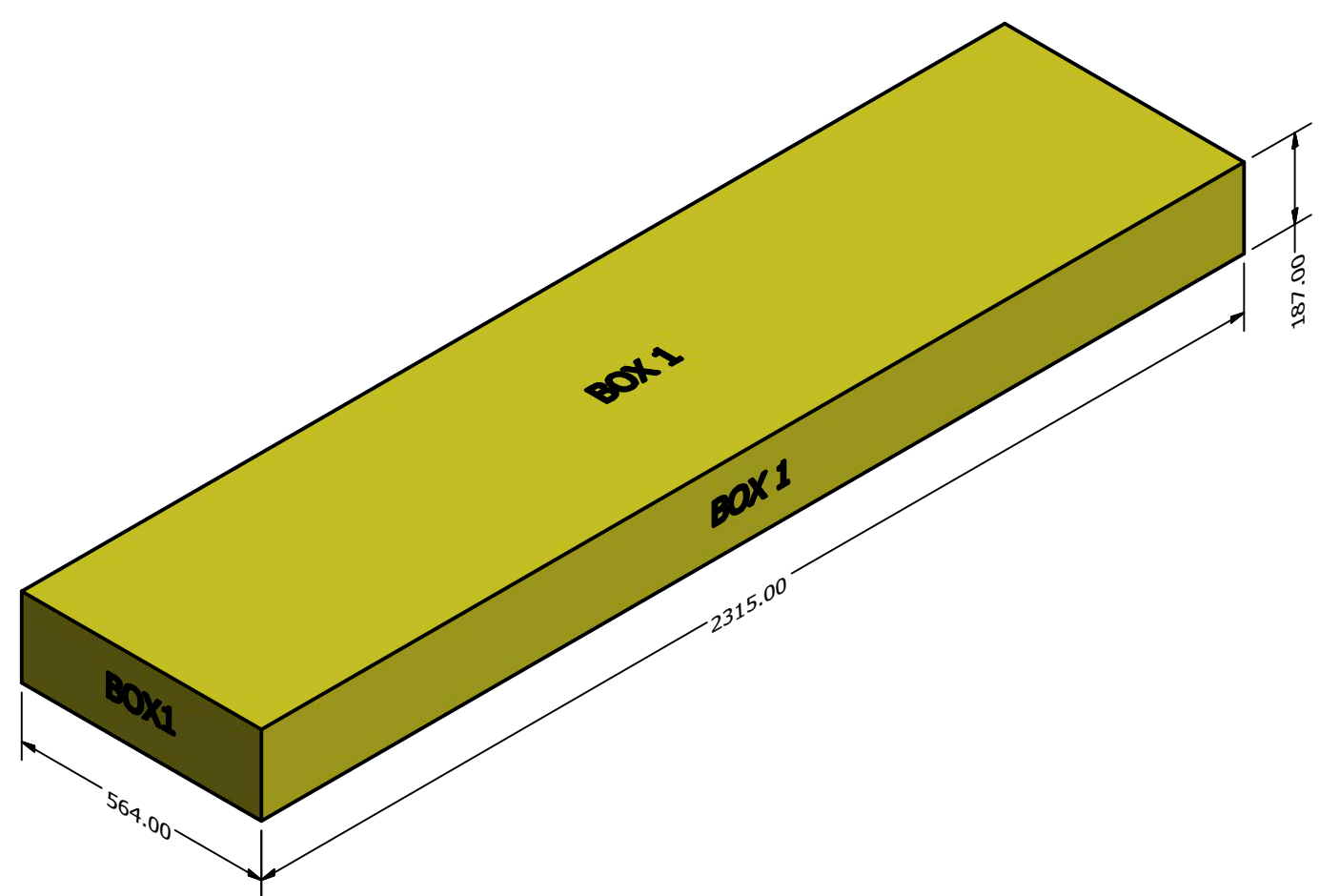

BOX1: 59kg

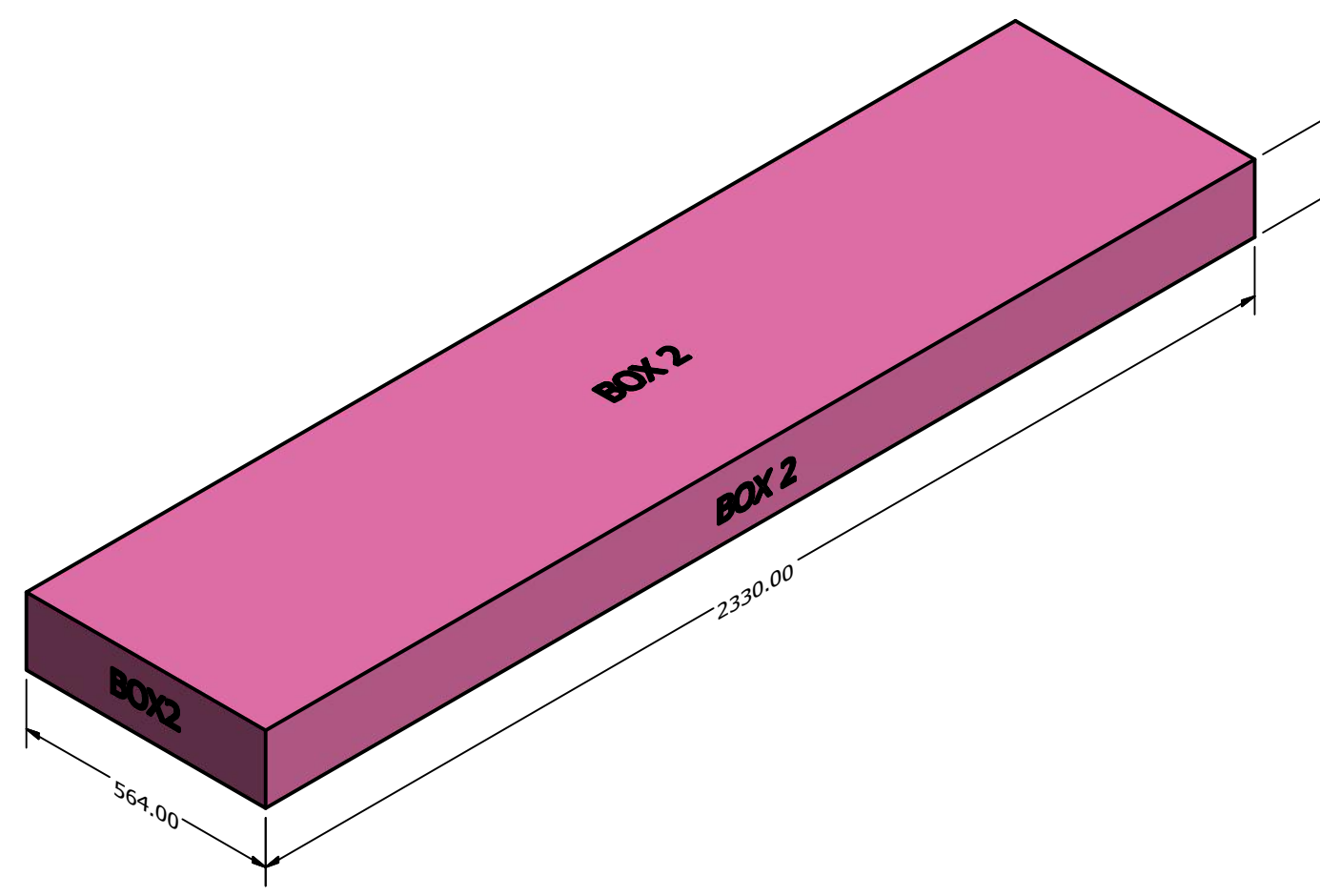

BOX2: 61kg

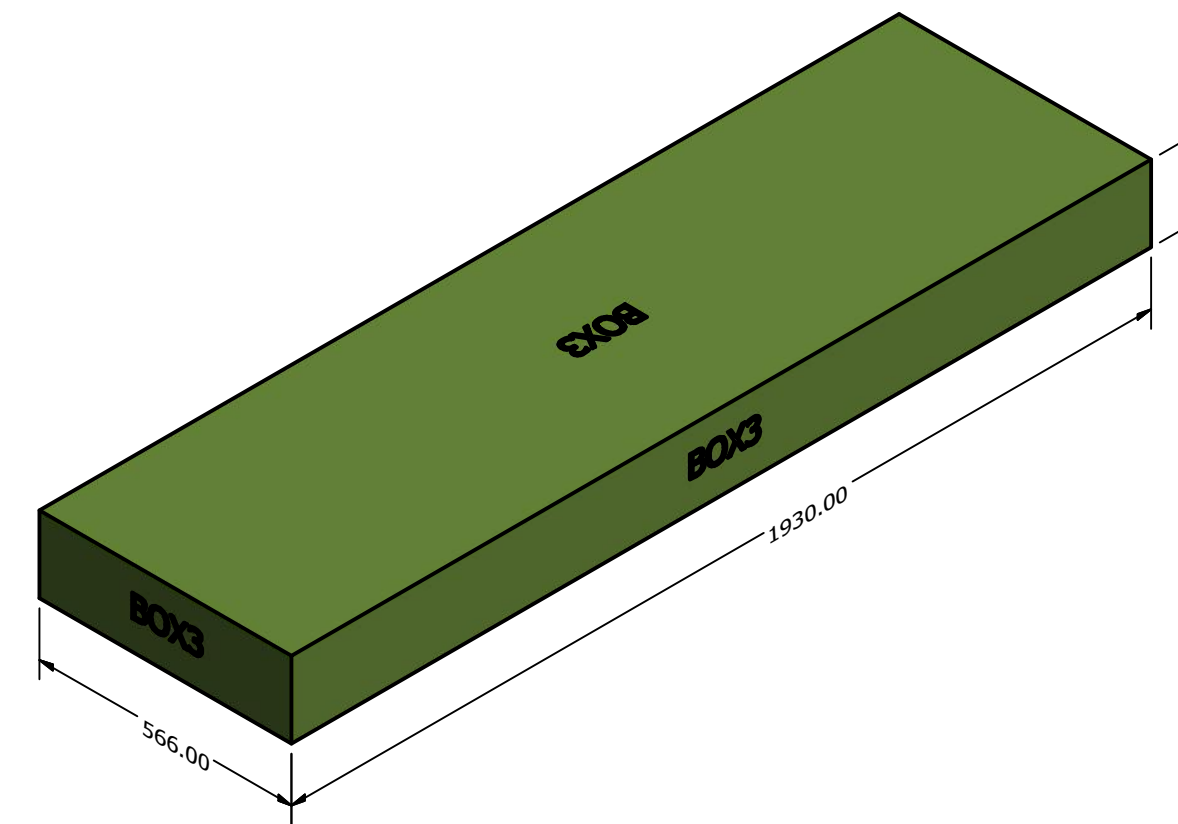

BOX3: 47kg

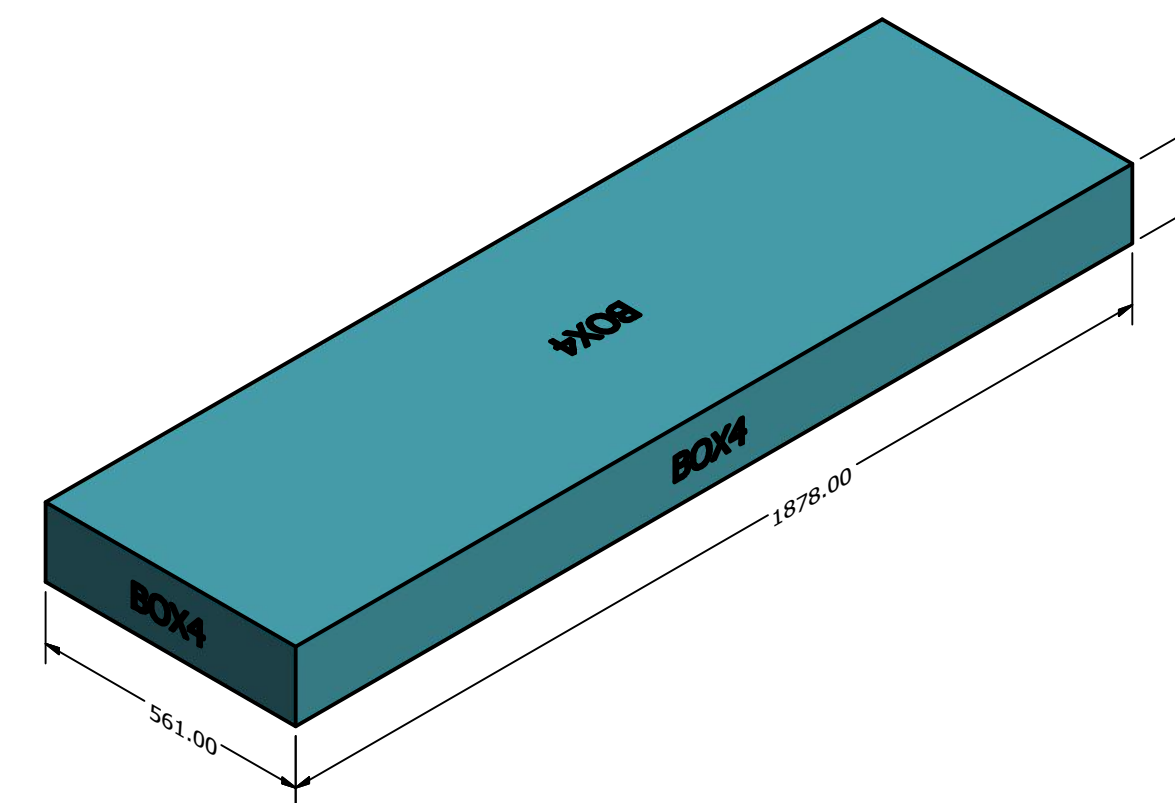

BOX4: 56kg

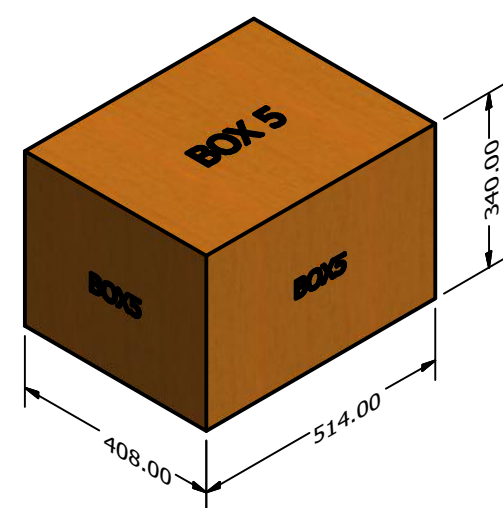

BOX5:12kg

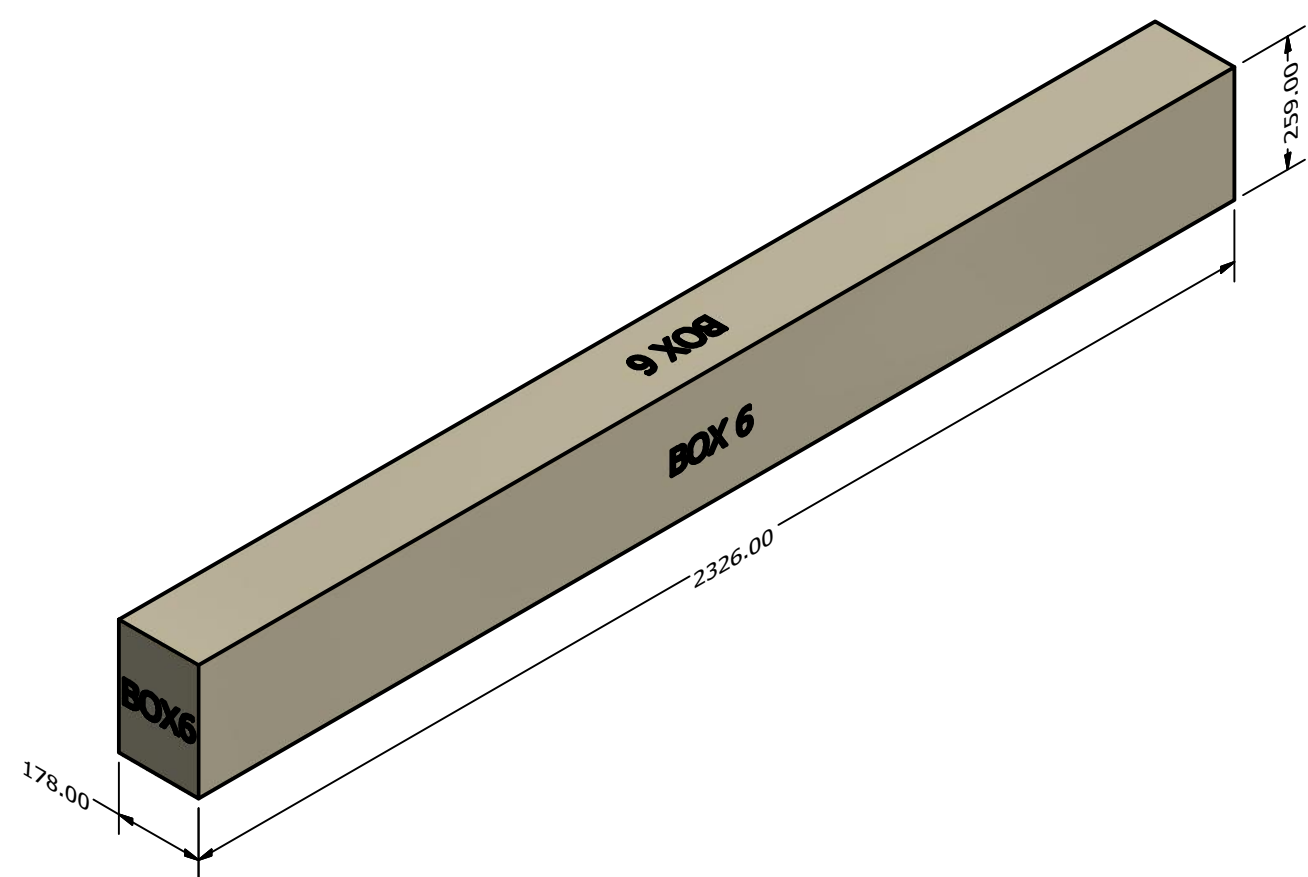

BOX6:31kg

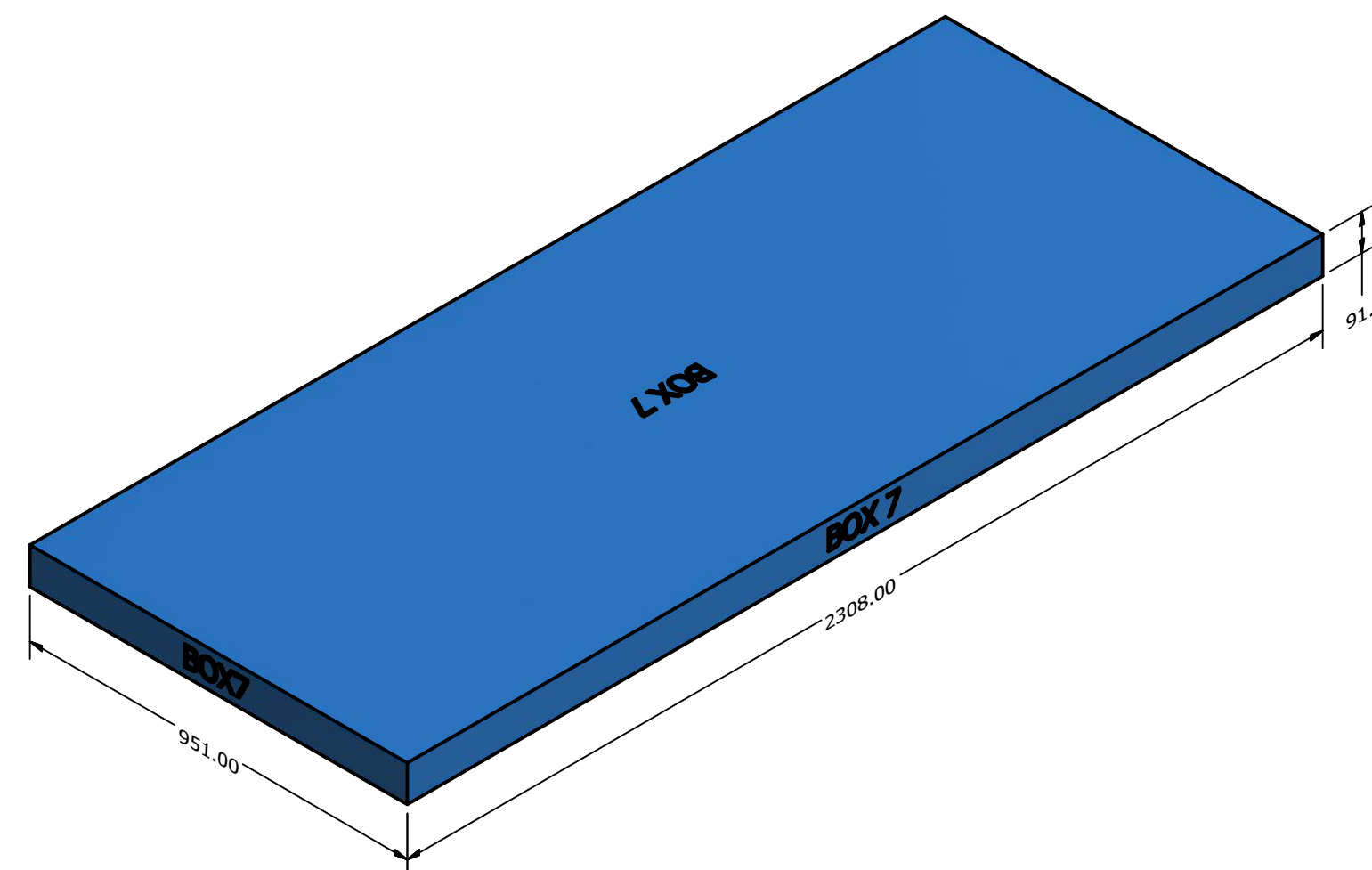

BOX7:44kg

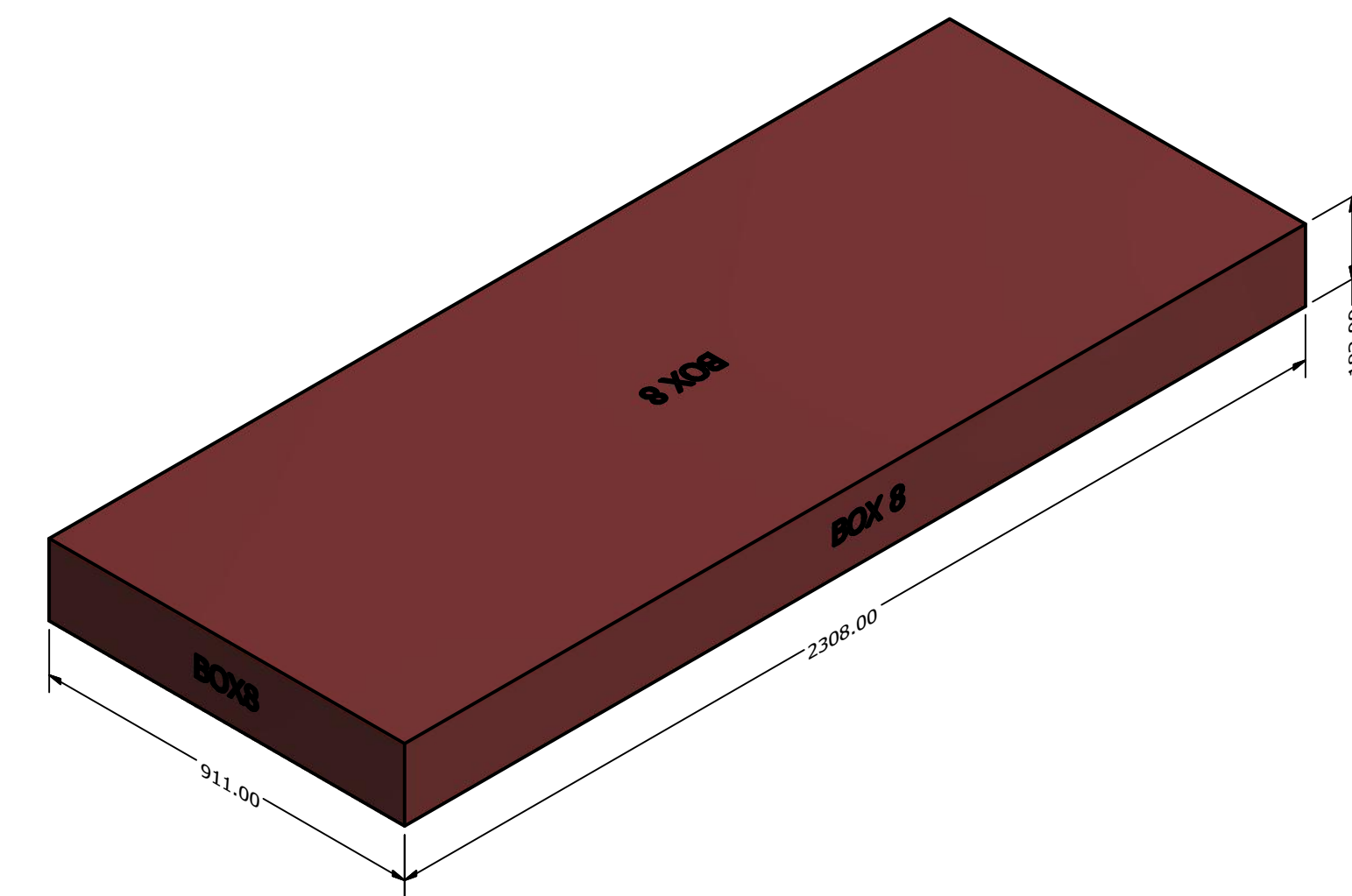

BOX8:88kg

DRAWN		TITLE		
CHECKED				
QA				
MFG				
APPROVED		SIZE	DWG NO	REV
		D		
		SCALE	1 / 12	SHEET 1 OF 1