

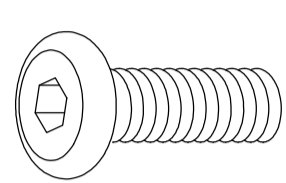
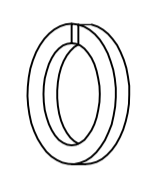
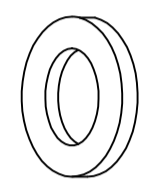
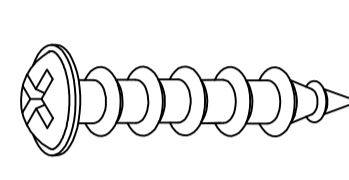
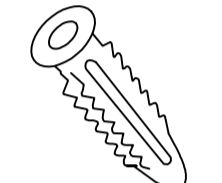
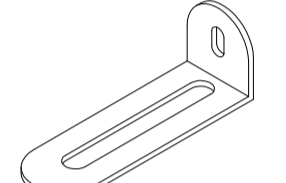

Thank you for purchasing this quality product. Be sure to unpack carefully looking for small parts which may have come loose during shipment.

Read all instruction and study the drawing carefully before starting the assembly process.

HARDWARE LIST

No.	Drawing	Description	Size	Q'ty
A		Allen Head Bolt	Ø1/4x1-1/8"	10
B		Lock Washer	Ø1/4"xØ11x1mm	10
C		Flat Washer	Ø1/4"xØ18x1mm	10
D		Wood Screw	Ø8x32mm	2
E		Plastic Anchors	Ø13xØ4x38mm	2
F		Brackets	77x25x25x2mm	2
G		Allen Key	4mm	1
H		Shelf pin	Ø6.35xL11mm	16
I		Metal Plate	102x20x2mm	4
J		Tipping restraint		1

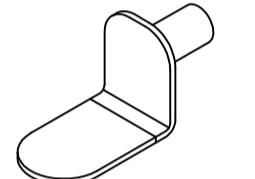
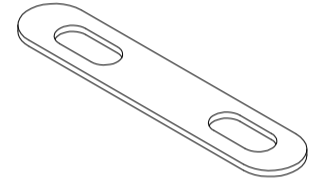
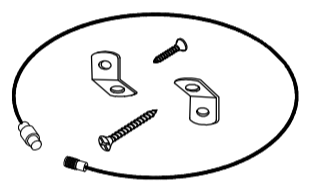
PART LIST

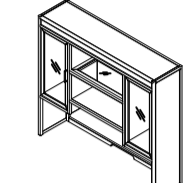
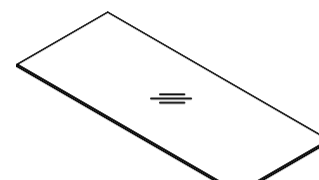
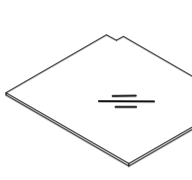
No.	Drawing	Description	Q'ty
1		Hutch	1
2		Middle Shelf Glass	1
3		Adjustable Shelf Glass	4

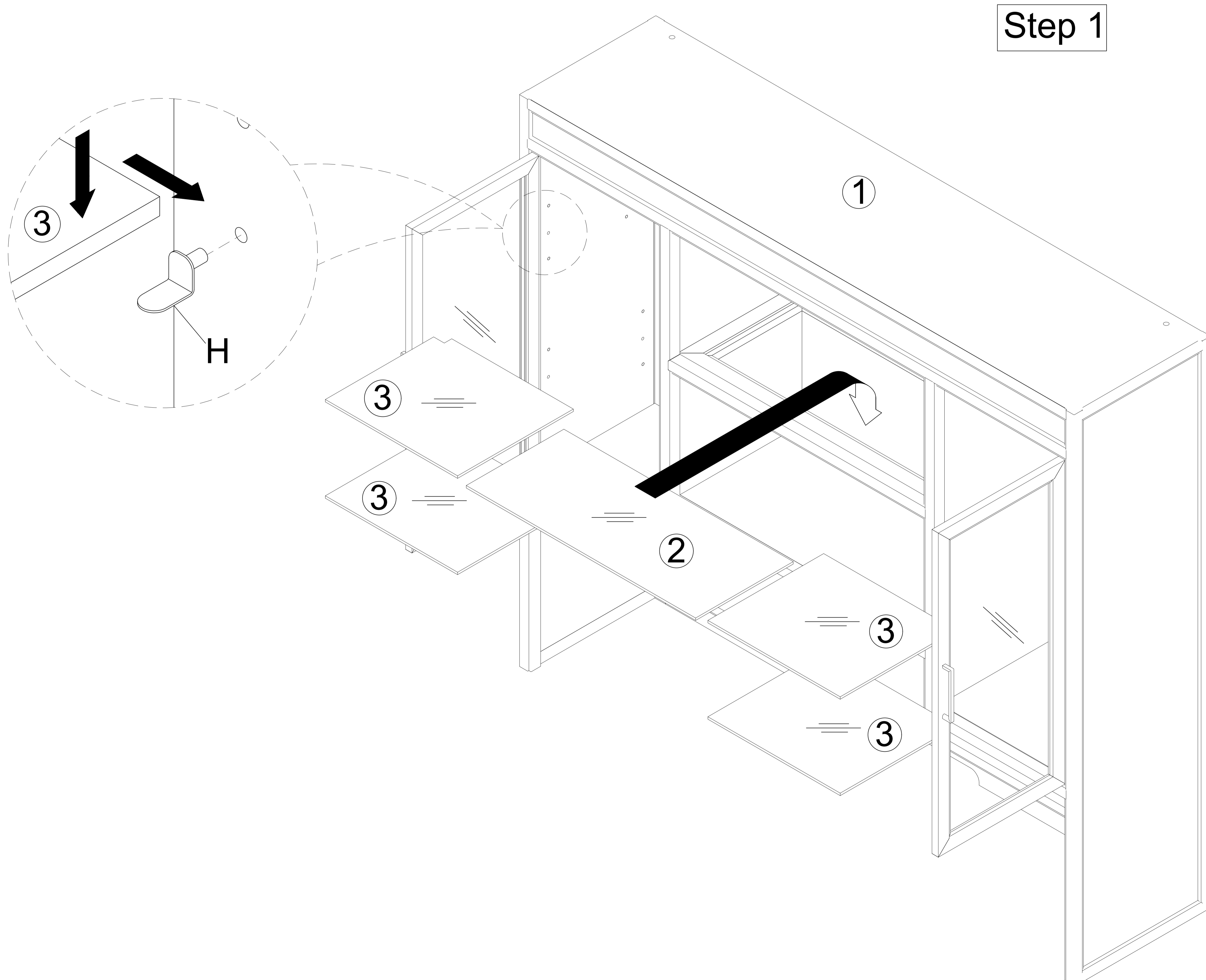



**** WARNING:** In order to prevent overturning, this product must be used with anti-tip kit restraint provided. Please ensure you follow the instructions enclosed with the pack and fit product securely to the wall.

Thank you for purchasing this quality product. Be sure to unpack carefully looking for small parts which may have come loose during shipment.

Read all instruction and study the drawing carefully before starting the assembly process.

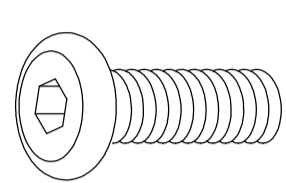
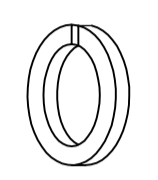
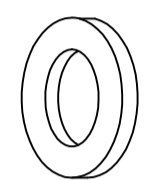
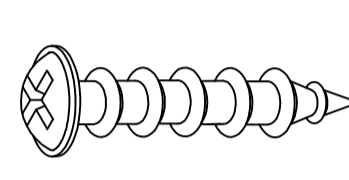
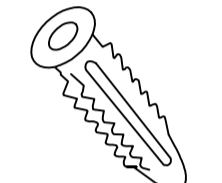
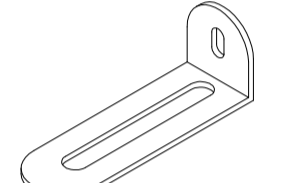
HARDWARE LIST

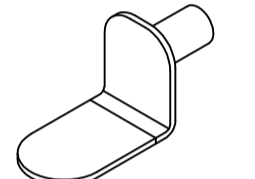
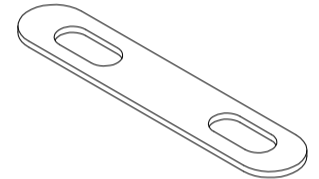
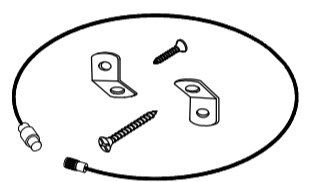
No.	Drawing	Description	Size	Q'ty
A		Allen Head Bolt	Ø1/4x1-1/8"	10
B		Lock Washer	Ø1/4"xØ11x1mm	10
C		Flat Washer	Ø1/4"xØ18x1mm	10
D		Wood Screw	Ø8x32mm	2
E		Plastic Anchors	Ø13xØ4x38mm	2
F		Brackets	77x25x25x2mm	2
G		Allen Key	4mm	1
H		Shelf pin	Ø6.35xL11mm	16
I		Metal Plate	102x20x2mm	4
J		Tipping restraint		1

PART LIST

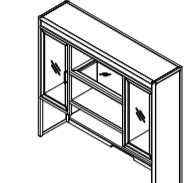
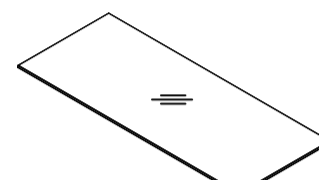
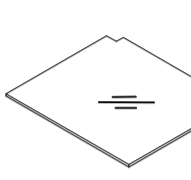
No.	Drawing	Description	Q'ty
1		Hutch	1
2		Middle Shelf Glass	1
3		Adjustable Shelf Glass	4

Step 3

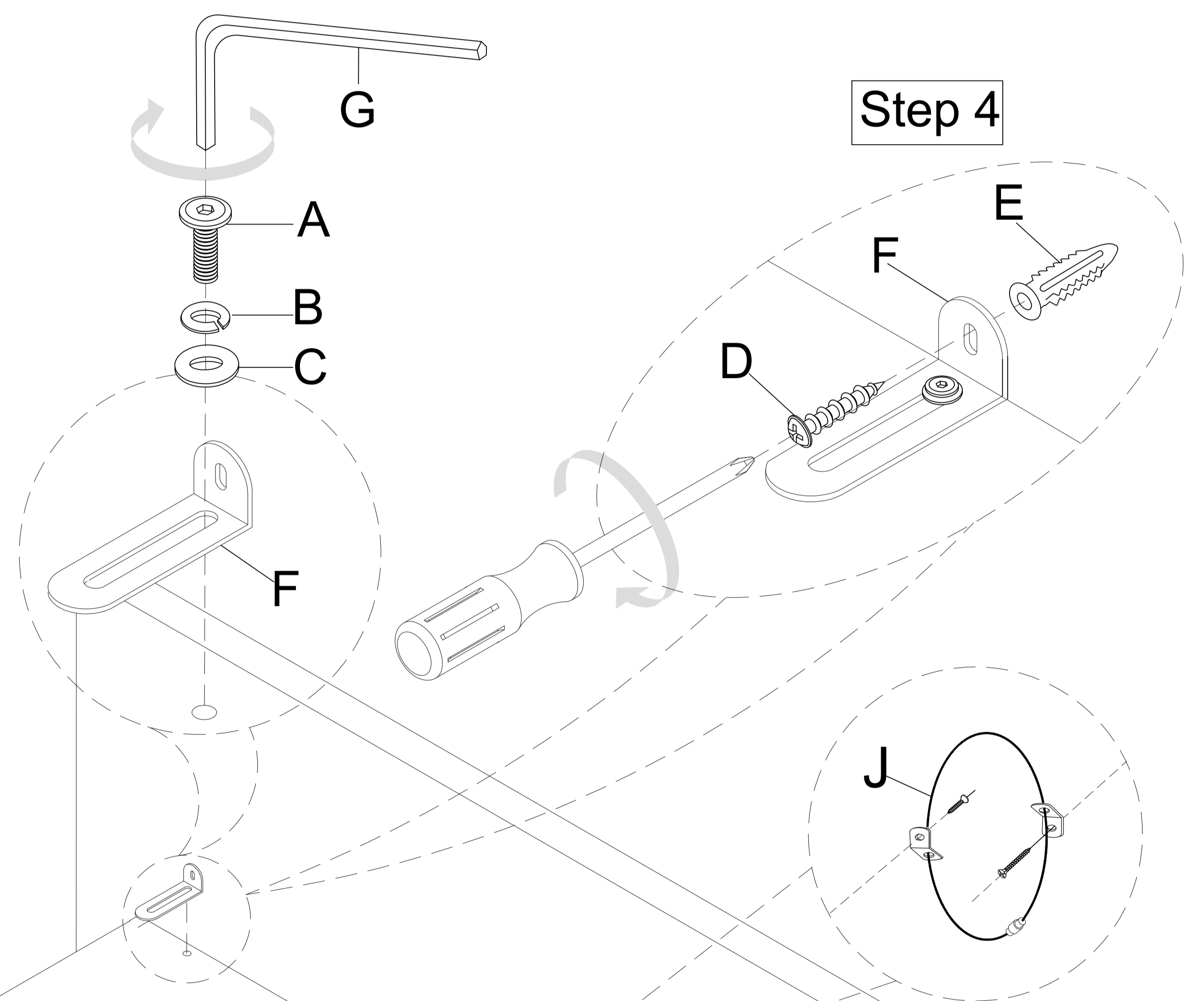

Step 4

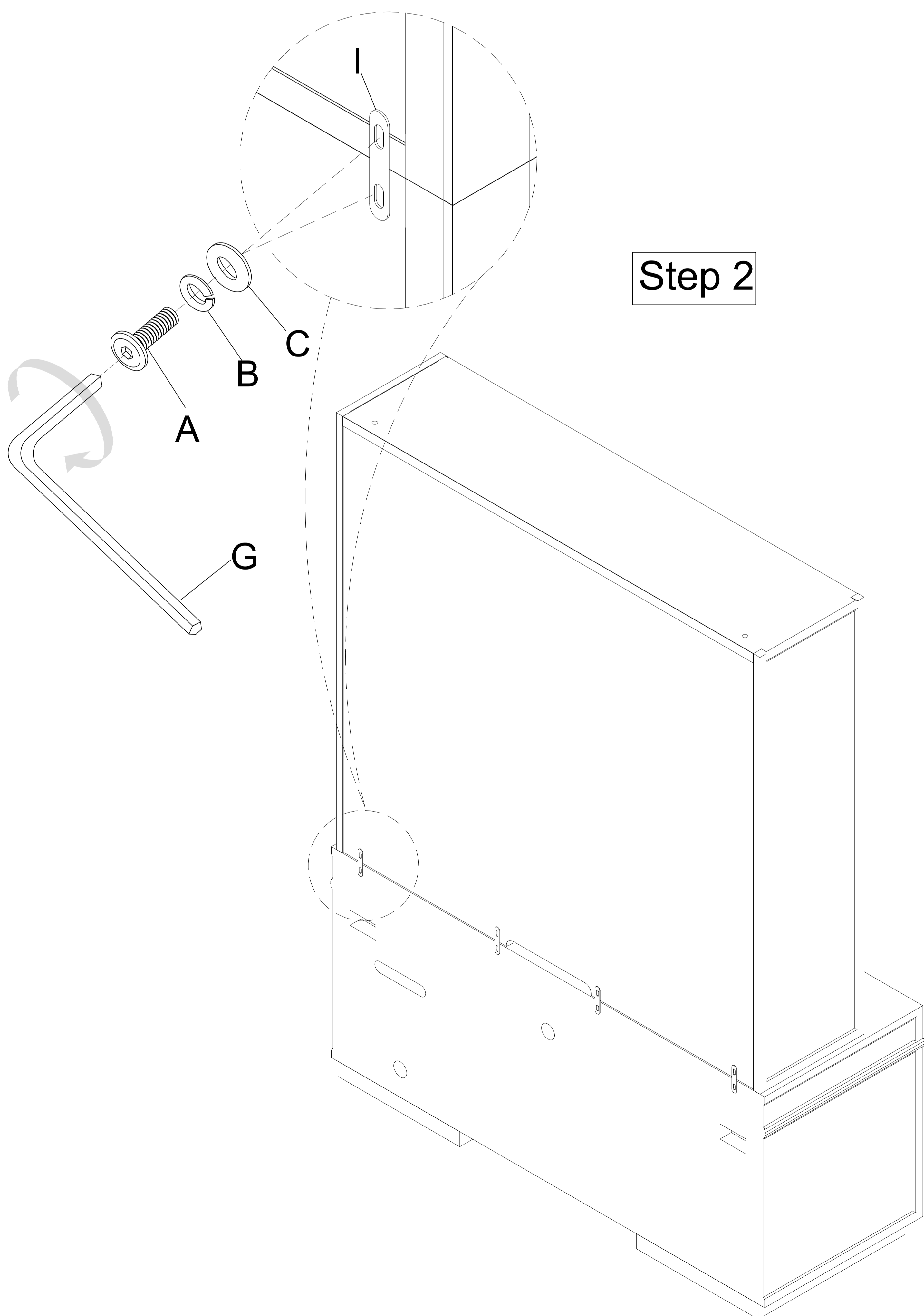

Step 2

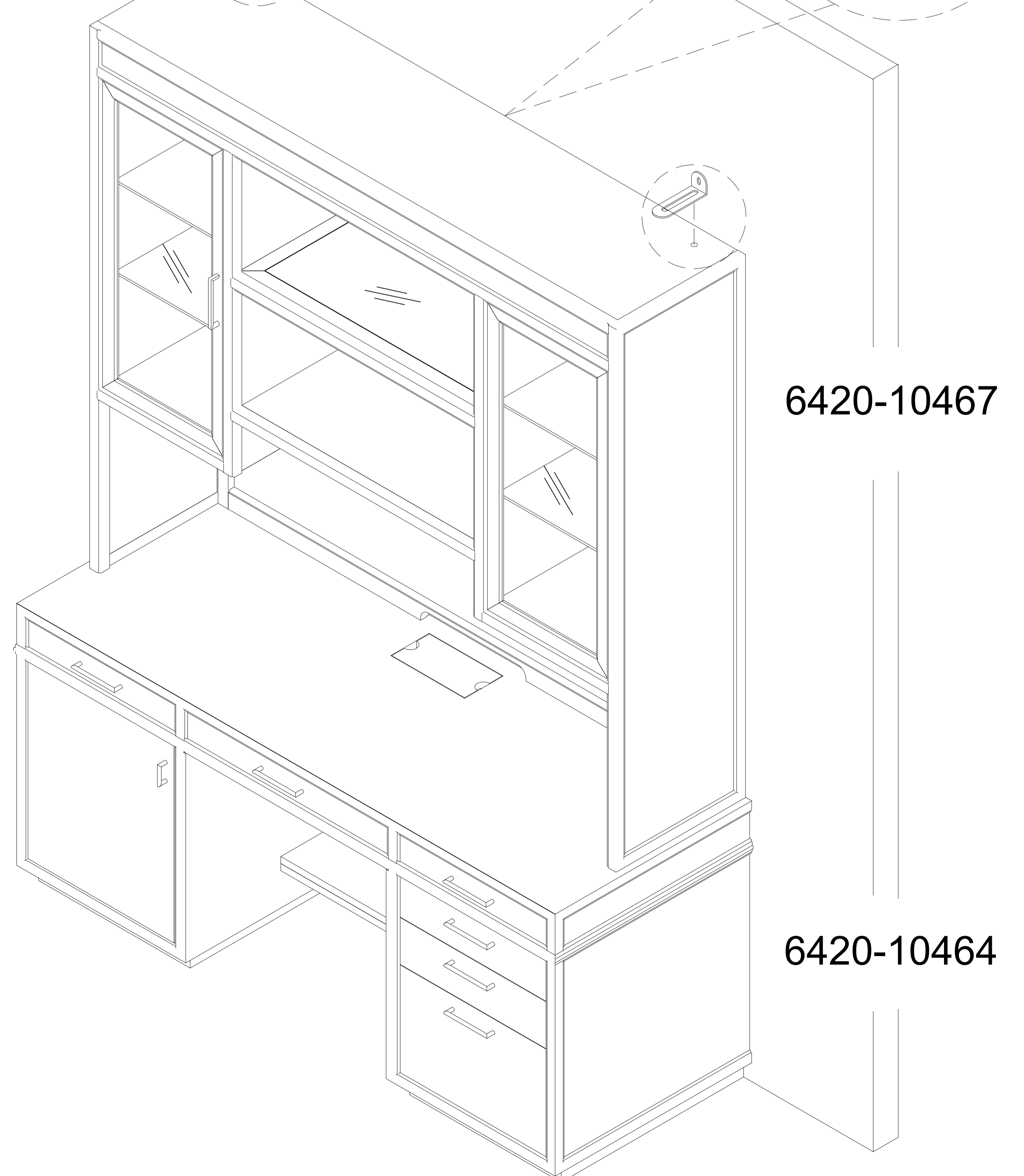

**** WARNING:** In order to prevent overturning, this product must be used with anti-tip kit restraint provided. Please ensure you follow the instructions enclosed with the pack and fit product securely to the wall.