

Features

- Low-threshold design for easy entry and exit
- Covered drain with removable cover
- Single threshold for alcove installation
- Coordinates with other products in the Archer collection

Material

- Acrylic

Installation

- Center drain

Recommended Products/Accessories

K-9132 Shower Drain
K-23726 Drain treatment

Codes/Standards







CSA B45.5/IAPMO Z124
ASTM E162
ASTM E662

KOHLER® Plastic Baths and Shower Bases Lifetime Limited Warranty

See website for detailed warranty information.

Available Colors/Finishes

Color tiles intended for reference only.

Color	Code	Description
	0	White
	96	Biscuit
	NY	Dune
	95	Ice™ Grey
	58	Thunder™ Grey
	7	Black Black™

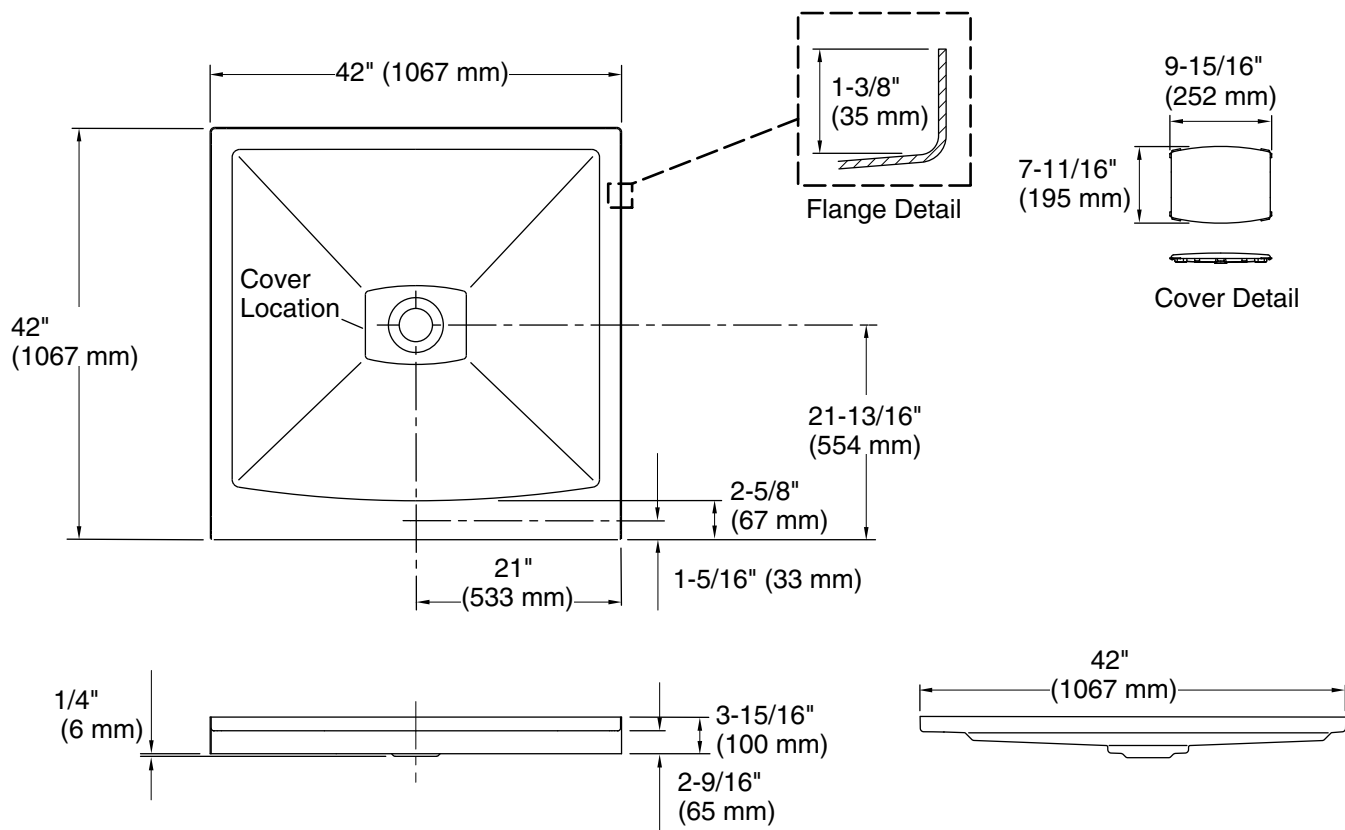

Technical Information

All product dimensions are nominal.

Drain location:	Center
Weight:	44 lbs (20 kg)
Minimum floor load:	20 lbs/ft ² (97.6 kg/m ²)
Minimum flat for door:	2-5/8" (66 mm)

Notes

Measure your actual product for rough-in details.

Install this product according to the installation instructions.

Shimming may be required to level the fixture.

Shimming may be required between the stud frame and the fixture.

Stud opening tolerance is + 1/4" (6 mm), - 0" (0 mm).