

Dotted line size: 483*432mm

Kräus®

www.kraususa.com

Model No.

KWU111-21

KWU1101-21-PGM

Undermount Cut-out

Pro Hotline: 516.801.8955

Customer Service: 800.775.0703

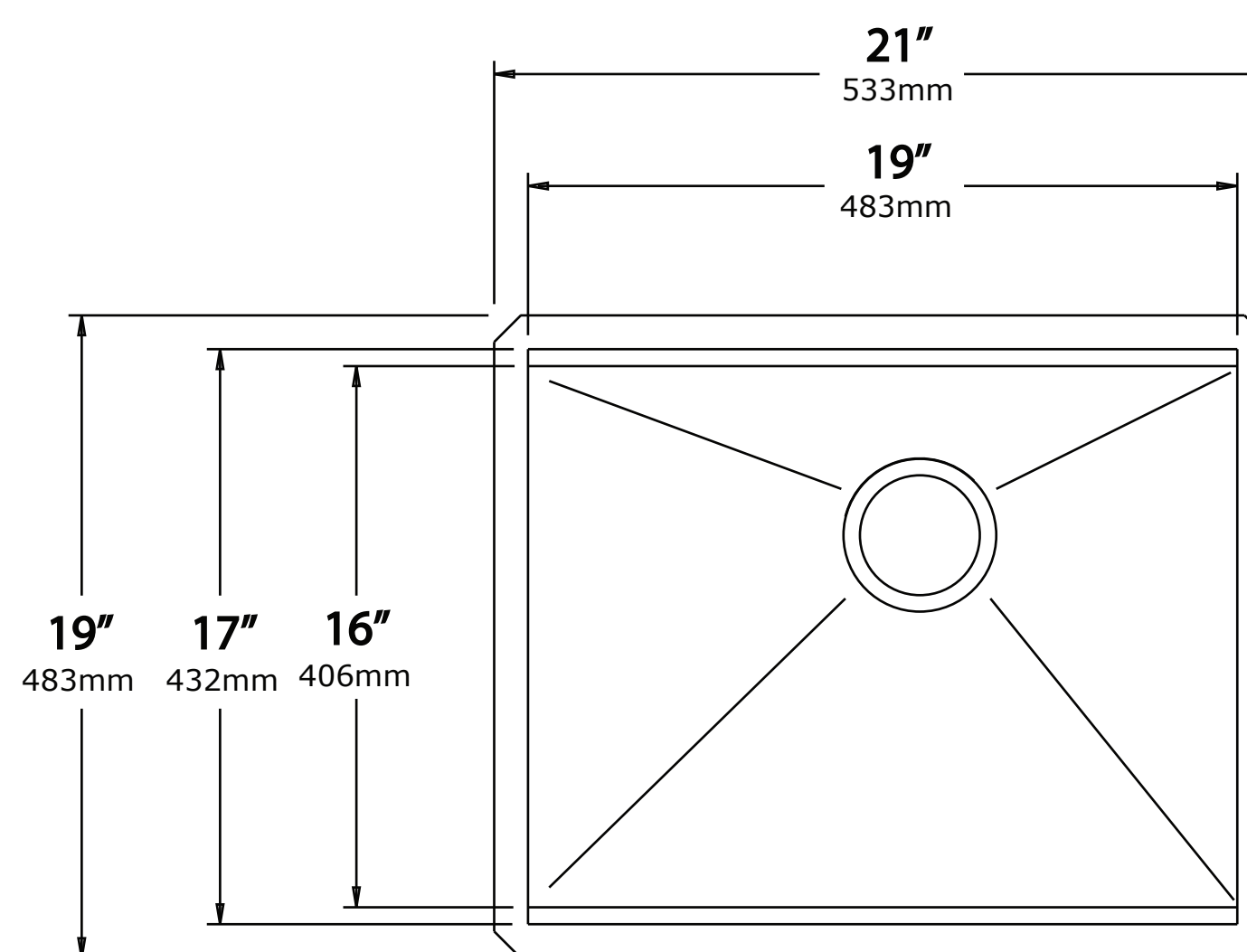

NOTE: Cutout template is provided as a guide **ONLY** and must be checked against actual sink to verify correct fit.

Please tear perforated edge for zero / flushed reveal →

Please use outer edge for positive reveal 3/8" →