



Rinnai®

Commercial Water Heating Solutions

For Trade Professionals



Application Engineering Center of Excellence

Our team of application engineers is available to provide quotes, size your system and provide designs for your specific project — all at no charge and backed by our 100% sizing guarantee. Using proven sizing methodologies, Rinnai's Application Engineering Center of Excellence is there to consult with you and provide the best total solution for your next project. Call them at **1-800-621-9419** or email at engineering@rinnai.us.

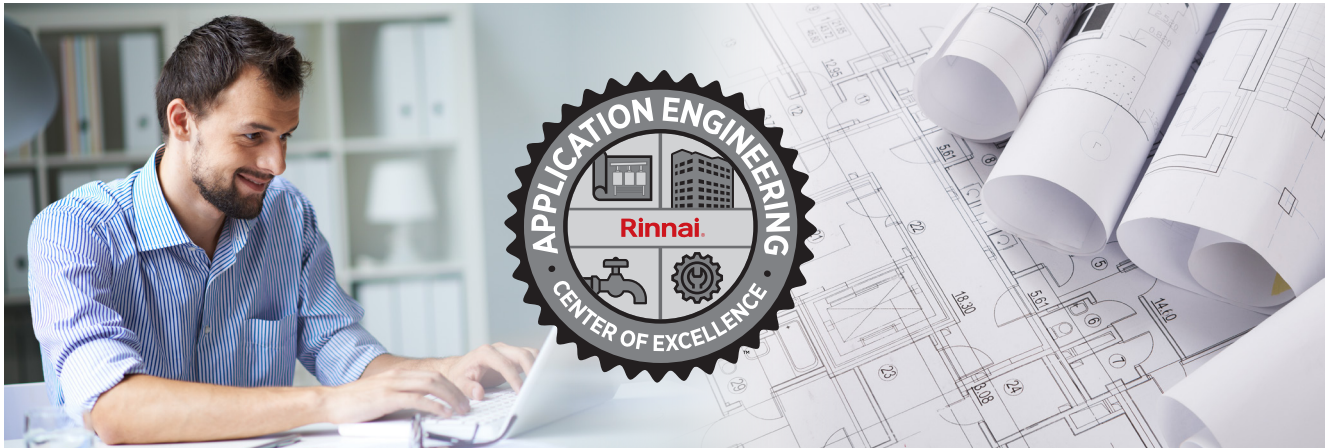

- Unmatched customer support
- Quick sizing and quote turnaround
- Proven sizing methodologies
- Cost effective – value engineered designs
- Utilizing storage when necessary
- Full system drawings and BOM provided
- ROI: Running cost/savings/carbon emissions calculations

- Custom engineered water heating solutions via Made to Order (MTO) process
- 100% sizing guarantee*
- On-site review and consultation if required
- Accessible tech documents: submittals, spec sheets, CAD drawings, Revit files and more

* Sizing is guaranteed provided original fixture list and sizing parameters (e.g., temps, elevation) do not change.

Rinnai® | National Accounts

No matter the size of your company, Rinnai's National Accounts Program makes it easy and affordable to stay in hot water.

Nationwide Support and Coverage

- Factory trained service providers on call and in your markets
- Immediate replacement, installation and preventive maintenance with just one call
- Water heating solutions that save money, last longer and save space

24/7/365 Emergency Rapid Response

- Dedicated toll-free number
- On site within 2 hours; repair within 4 hours; replace within 8 hours of approval
- Continuing updates to facilities managers

New Construction or Planned Replacement

- 100% Sizing Guarantee from Rinnai Applications Engineering
- Existing equipment audit to prevent failures and unexpected repairs
- Turnkey delivery and installation

Contact the Rinnai National Accounts Team today to sign up or learn more: **844-348-4714** or NCA@rinnai.us.

We've Got Your Back

Along with our national network of installers, our products are backed by commercial services that include application engineering and sizing, **24/7/365 tech support and direct preventive maintenance services, as well as an extensive warranty.** The warranty coverage includes 8 years or 12,000 hours of operation for the heat exchanger, 5 years parts, and 1 year labor. In other words, we've got you covered.



The Highest Standards of Quality

- Rinnai employs more than 600 research and development engineers, all focused on uncompromising quality in design and manufacturing
- Advanced automation and precision assembly processes have made our manufacturing facilities an industry model for efficiency
- Every product undergoes a series of live testing before shipping
- Rinnai America is one of the few tankless water heater providers with its own state-of-the-art Canadian Standards Association (CSA) Certified Testing Laboratory, including CSA accredited lab technicians
- All products distributed in North America have been approved by the CSA and adhere to the strict standards of the American National Standards Institute (ANSI)



First Major Tankless Brand to Build Tankless Product in North America

Rinnai opened the facility and began assembling non-condensing tankless and commercial water heating products at its Griffin, Georgia factory in 2018. In addition to creating jobs and contributing to the local economy, the manufacturing facility solidifies the industry leader position Rinnai holds and further demonstrates its commitment to innovate and drive category growth in North America.

For complete details on commercial water heating solutions and maintenance services, call **866-383-0707** or email **commercialservices@rinnai.us**.

TABLE OF CONTENTS

WHY CHOOSE RINNAI	4
RINNAI CENTRAL APP	5
CX AND CXP	8
DEMAND DUO®	10
DEMAND DUO® H-SERIES.....	12
DEMAND DUO® R-SERIES.....	14
TANKLESS RACK SYSTEMS.....	16
SPECIFICATIONS.....	22
VENTING.....	28
ACCESSORIES.....	34

Why Choose a Rinnai system?

- Decreased operational costs
- Energy savings
- Durability for the demands of business
- Space savings
- Redundancy of units eliminates downtime
- Multiple venting options
- Maintenance alerts
- Wi-Fi capable



DEMAND DUO® H-SERIES
119-GALLON HYBRID COMMERCIAL
WATER HEATING SYSTEM



TRX02
TRX COMPACT WALL-MOUNT
TANKLESS RACK SYSTEM



Building Management System Gateway

Remotely monitor and control up to 24 Rinnai Commercial Water Heaters. Turn tankless water heaters on or off, adjust water temperature, monitor status, and more.

- Pair up to 6 Rinnai Commercial Condensing Water Heaters per Gateway, up to 4 Gateways per Network
- Works with the Rinnai CX199, CX160 models, and all Demand Duo H-Series models
- Stand alone operation with optional Touch Screen User Interface
- Integration with BACnet, Modbus and LonWorks® communication protocols
- System of UL Certified and Recognized Components

How Modulation Works

The chart below demonstrates the efficiency that a fully modulating tankless system can provide. The chart generally shows the gas usage of a traditional boiler compared to that of a Rinnai Tankless Water Heater.* Peaks represent the tankless unit meeting user demands, and valleys represent saved energy in between.

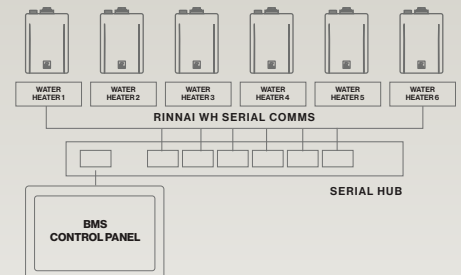
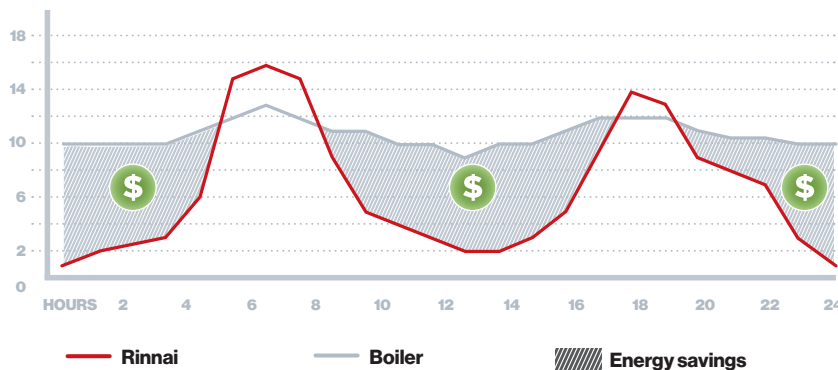

SENSEI[®] CX

SERIES

Built for the PRO, by the PRO™

WHY RINNAI?

Set-up and Registration has Never Been More Convenient

1 Download and Open the Rinnai Central™ App

Open and create your account today to gain instant access to product information, training resources, and set-up procedures...**plus much more!**



SCAN ME



SCAN ME



2 Initiate Set-up (Wi-Fi not required)

Push the **Bluetooth** button on the tankless controller with the **Rinnai Central™** app open to **SMARTCONNECT** to your device.



Use the **Quick Set-Up** screen for speedy unit configuration.

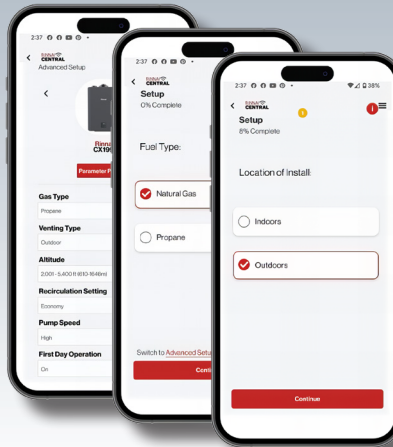

Fuel Type
SMARTSENSE lets you select the fuel source without removing the cover!

Indoors / Outdoors
VERSASVENT cap allows any unit to install outdoors (purchased separately)

3 Register the unit

Now your customer can take full advantage of the **Rinnai Warranty** and extended service plan.



Unsurpassed **6 Years** on the Tank*
8 Years on the Heat Exchanger
5 Years on Parts
2 Years on the Labor

*Versus 3 Year Warranty offered by most tank manufacturers

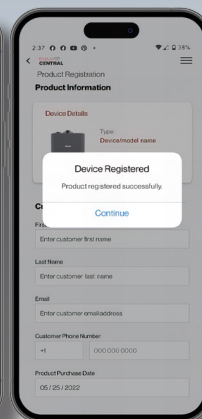
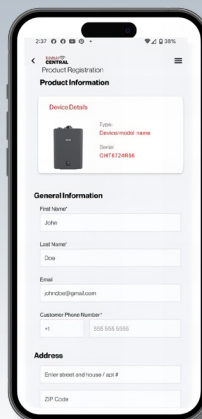

Rinnai Commercial Water Heating Solutions To Meet Any Demand



SINGLE UNIT

TANK-TANKLESS HYBRID WATER HEATING SOLUTIONS

1 CX199 Tankless Water Heater

FEATURES AND BENEFITS:

- Precision engineered to provide an endless supply of hot water for commercial applications
- Increased operational performance, longer warranty, easier installation, enhanced serviceability and more venting options

2 Demand Duo® H-Series

FEATURES AND BENEFITS:

- Heats Water in Tankless – Zero Thermal Stress on Tank
- Demand Duo® 2V saves space and delivers 551 gallons First Hour @ 100°F Delta T
- Direct replacement for High Efficiency tanks

3 Demand Duo® R-Series

FEATURES AND BENEFITS:

- Cold Water Inlet Connection at the top of the tank
- Pre-installed Exhaust Connector
- Included 3-Piece 6" Vent Accessory Kit
- Direct Replacement for Atmospheric tanks



RINNAI TANKLESS RACK SOLUTIONS

4 TRS Free-Standing System

FEATURES AND BENEFITS:

- Great for hospitality, multi-family, industrial, schools, dorms, food processing
- Direct replacement for domestic boilers

5 TRW Wall-Mount System

FEATURES AND BENEFITS:

- Great for food service, hospitality kitchens, laundries, zoned systems
- Replaces medium to large, standard and HE tanks, small boilers plus storage

6 TRX Compact Wall-Mount System

FEATURES AND BENEFITS:

- 10.8 gpm Flow Rate at 70° rise
- Takes up minimal wall space
- Mounts over existing wall conditions with offset wall bracket
- Fully assembled on Frame with factory-tested manifolds
- Convertible to free standing rack with accessory kit

SENSEI[®] CX

SERIES

Built for the PRO, by the PRO™



SENSEI CX offers a new, more compact and enhanced combustion design that allows for easier installation and enhanced operational performance and serviceability. All of the key components in SENSEI are designed and manufactured by Rinnai – ensuring maximum quality and reliability from the industry leader in commercial tankless water heating solutions.

- You can now vent with 2 in. PVC up to 75 ft.*
- You can vent using 2 in./4 in. or 3 in./5 in. concentric pipe*
- The most Common Venting options offered to meet commercial needs
- Stainless Steel Primary Heat Exchanger
- Integrated temperature up to 185° F
- Cascade Cable Assembly allows for up to 24 water heaters to be connected and function as one hot water source

*Single unit only



SMART SENSE™

Rinnai's proprietary Adaptive Gas Valve Technology adjusts to either Natural Gas or Liquid Propane Gas for optimal combustion — **no conversion kit required.**



VERSA-VENT™

Outdoor Vent Cap easily adapts to any SENSEI® CX Series model for outdoor installations providing the ultimate in SKU flexibility (sold separately).



SMART CONNECT™

Allows you to connect your smart phone or tablet to the SENSEI® CX Series via Bluetooth®. Use the Rinnai Central™ App for quick, simplified tankless water heater set-up and registration, significantly reducing your install time.

Look Inside

All components work together harmoniously to provide the best combustion performance possible.

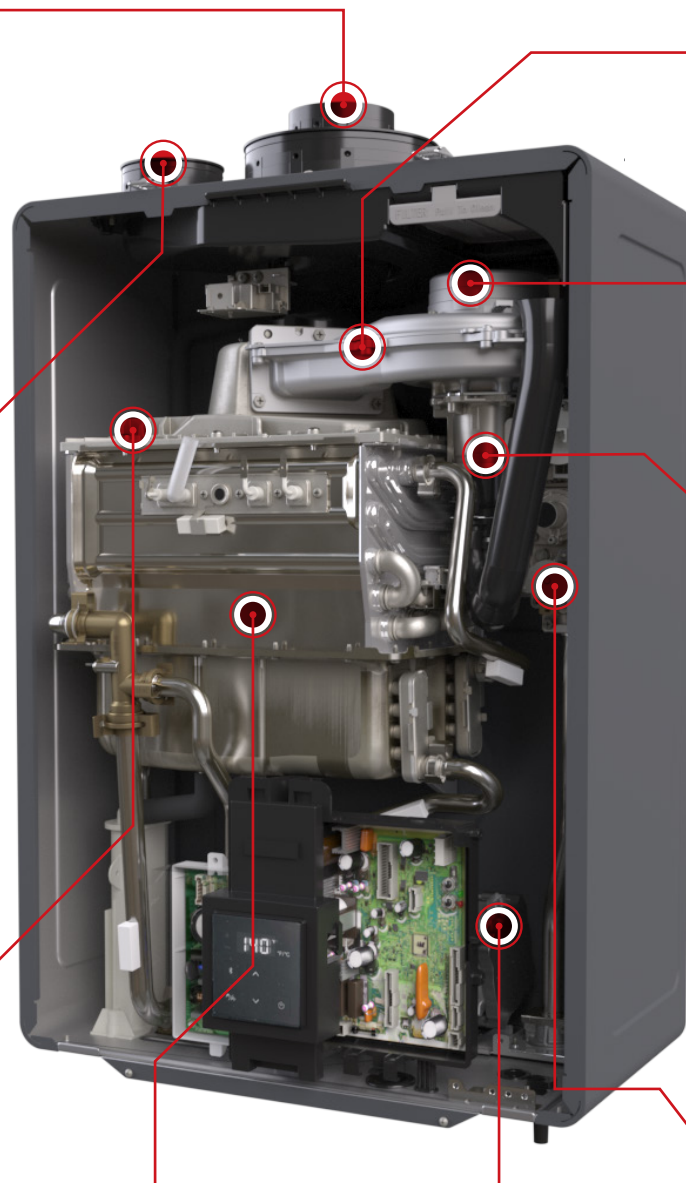

Concentric Vent or 2-Inch Exhaust

- Allows for easy use of concentric 2 in. / 4 in. or 3 in. / 5 in. direct vent or exhaust in 2-pipe or room-air configurations

2-Inch Intake Vent Connections

- Allows for maximum flexibility with the use of 2 in. PVC/CPVC/PP on vent runs up to 75 feet

Fiber Mesh Premix Burner

- Provides even flame distribution for optimal performance for any demand

NEW Enhanced Primary and Secondary Heat Exchangers

- More efficient heat transfer to inlet water and improved robust design with minimal joints.
- The tube design is 1mm thick (25% thicker than competitive products) 444 Stainless Steel and fluorine gaskets are used at the joints to provide added durability and heat resistance.

Integrated Pump Model (CXP)

- Integrated Pump Model (CXP)
- CXP models available in both 199k and 160k Btu options
- Pair multiple CXP models to share equal pump usage

Integrated Check Valve

- Located between the turbo fan and combustion chamber, prevents cold air from entering the venting system and backflow of exhaust in common vent applications

Turbo Fan

- **NEW** Improved Turbo Fan™ enables longer vent runs and flexible vent options. Industry leading 75 feet with 2" / 4" concentric and 2" PVC/CPVC/PP Up to 150 feet with 3" / 5" concentric and 3" PVC/CPVC/PP

Switching Venturi

- Provides consistent mixture of air and gas to burner for low turn-down ratios
- Self-compensates in areas with low or fluctuating gas pressures

Zero Governor Gas Valve

- **NEW** Smart Sense™ Gas valve control system compensates variation in gas heating value for optimal combustion —no orifice conversion required

BUSINESSES
RELY on

Rinnai™

Demand Duo Hybrid Water Heaters come fully assembled with time saving features that enable a fast and easy connection to gas, water and electric. And Rinnai's reputation for quality means no costly callbacks and an unsurpassed warranty that is more than 2X greater than most tanks on the market.

Upgrade today to a better performing and more reliable form of commercial water heating that businesses across North America rely upon every day - Demand Duo H and R-Series.



Application Engineering Center of Excellence

Our team of application engineers is available to create quotes, size your system and provide designs for your specific project — all at no charge and backed by our 100% sizing guarantee*. Using proven sizing methodologies, Rinnai's Application Engineering Center of Excellence is there to consult with you and provide the best total solution for your next project.

**Call them at 1-800-621-9419 or
email at engineering@rinnai.us.**

* Guarantee is based on customer submitted fixture types and quantities at the time of sizing request. Infrared Heater sizing provided by Rinnai does not qualify for Rinnai's 100% sizing guarantee.

Rinnai. Learn more at rinnai.us

The Time is Right to Switch to Demand Duo®.

Easy installation, superior performance and longer life mean there has never been a better time to switch from traditional tanks to the consistency and efficiency of Demand Duo H- and R-Series solutions.

Maximum Performance that Lasts Longer

- Unsurpassed 1st-hour delivery and efficient tank recovery keep pace with demand
- Saves money with lower energy costs
- Longer warranty – more than 2X longer than traditional tanks

How Demand Duo Works

Water heats in the tankless unit rather than inside the tank, providing:

- Zero thermal stress on the tank
- More hot water capacity, since tank only holds two magnesium anode rods
- Easy, cost-effective tankless maintenance versus replacing an entire tank every few years
- Ideal for emergency replacement; installs like a tank but over 100 lbs lighter than most tanks

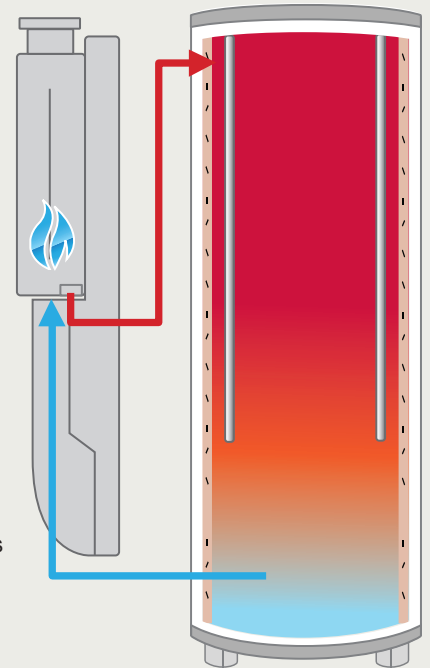

Transforming the Way Water is Heated.

Fox Run Apartments | Multi-Family

THE SMARTER WAY TO DO HOT WATER

Fox Run Apartments in Cincinnati, OH has 240 living units across 19 buildings. The owner, BRG Realty, dealt with rising electrical rates and soaring maintenance costs to run and repair their existing electric tanks that serviced 12 apartments per building. By converting to Demand Duo condensing units in each building, BRG has improved renter satisfaction and **netted over \$20,000 in combined energy and maintenance savings** in the first year. "The maintenance is lot easier with Demand Duo and we no longer have to worry about constantly replacing heating elements and fuses, said BRG Maintenance Director Mike Markus. "The reliability of Demand Duo has been a great deliverable to BRG and our residents."



University of British Columbia – Okanogan Campus | Education

SAVINGS FROM DAY ONE

Located in Kelowna, Canada, this campus of 9,120 students recently installed 3 Demand Duo 2V commercial hybrid water heaters in a residence hall that services 72 living units equipped with 2 bd/1ba and a kitchen. With 2 tankless units attached vertically to a 119-gallon tank, the Demand Duo 2V provides more redundancy, 551 GPH and better serviceability than other traditional water heating systems. "The Demand Duo's are 12-18% more efficient than most of the commercial tanks we encounter plus they have more than 2X the warranty" said Brent Watson, Owner of Vision Mechanical who did the installation at UBC Okanogan, "and that makes them ideal to meet the extreme hot water demands of a university residence hall."



Crowne Plaza Atlanta – Midtown | Hospitality

WORRY-FREE INSTALLATION

Rinnai's total turnkey solution for this 432-room hotel delivered immediate savings on energy costs in November 2019. Managing all aspects of design, logistics, installation and billing, Rinnai replaced two aging, increasingly inefficient dual-burner boilers with 10 Demand Duo 2 Hybrid Water Heating units. Now, **Demand Duo's 97% thermally efficient system serves all the domestic hot water needs for the property**, fitting in the same footprint as just one of the boilers and freeing up space in the mechanical room. Additionally, two Demand Duo 2 units in the sub-basement supply all the hot water needs of the hotel's commercial kitchen and laundry.



Performance. Reliability. Peace of Mind.

High-Efficiency Hybrid Technology.

Venting Options

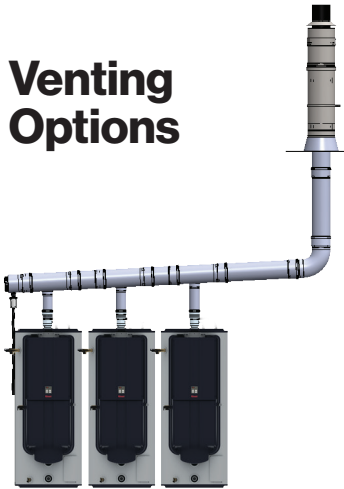

H-SERIES VENTING OPTIONS

Available in:

Single Vent: Two Pipe PVC/CPVC, Concentric Polypropylene (PP)

Common Vent: PP and PVC/CPVC
Common venting means significantly fewer wall or roof cuts, less labor, and longer vent lengths with single-unit venting.*

Installation Ease

- 1 Multiple Venting Options, Easy to Install
- 2 Pre-assembled Gas Connection
- 3 Pre-assembled Electrical Connection

Optimized Performance

- 4 **NEW** Dual Thermistors for Increased Temp Control
- 5 **NEW** Integrated Pump Control with Optimized Recovery Logic

- 6 Multiple Tankless Options

Multiple Sizes

- 7 80 or 119-Gallon Tank Options



WHERE SMART PERFORMANCE MEETS QUICK INSTALLATION



- Optimized pump design for increased flow and faster recovery
- DuoSmart® Digital Controller for precise temperature control and integrated recirculation
- Free system sizing with 100% guarantee

- Gas swivel flex line rotates 360° for 36", 180° radius connection to gas line
- Factory installed gas dirt leg
- Factory installed electrical access
- Lighter weight for easier handling
- Pre-assembled condensate drain



Pre-installed Electrical



DuoSmart® Digital Controller



High Flow Recovery Pump

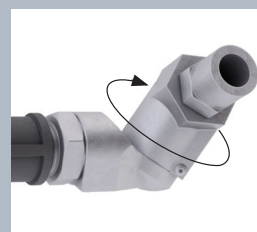

Two-way Gas Line Rotation for Easy Installation

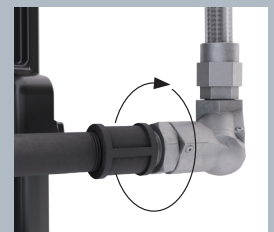

 <p>SAVE TIME WITH FACTORY INSTALLED COMPONENTS</p>	<p>\$250</p> <p>EST. SAVINGS WITH FACTORY INSTALLED COMPONENTS</p>
<p>551</p> <p>UP TO 551 GALLONS FIRST HOUR DELIVERY @100°F Δ*</p>	<p>33-46%</p> <p>SMALLER FOOTPRINT, UP TO 46% SPACE SAVINGS**</p>

When maximum performance and high efficiency are critical, the Rinnai Demand Duo H-Series Condensing Commercial Hybrid Water Heating System delivers. Customers never miss a beat with hot water, whether it's brief, high-spike draws or continuous, heavy use, day-in and day-out.

- Demand Duo 2V stacks tankless engines vertically – saves valuable commercial space
- Available in a wide range of Btu outputs and tank sizes
- ASME-certified tank (optional) list models
- Install without removing lower cover

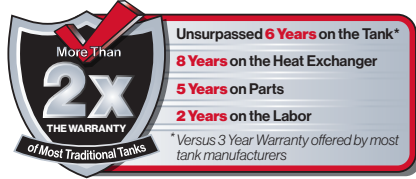

- High altitude approved to 10,100 ft.
- BMS compatible
- Wi-Fi capable











Before



After / Demand Duo 2

DEMAND DUO H-SERIES SPECIFICATIONS | CONDENSING MODELS

MODELS	Demand Duo® 2 / 119 GAL					Demand Duo® 119 GAL		Demand Duo® 80 GAL	
									
Model	CHS398100HCXIN	CHS398100HCXINA****	CHS398100HCXVIN	CHS398100HCXVIN****	CHS320100HCXVIN	CHS199100HCXIN	CHS160100HCXIN	CHS19980HCXIN	CHS16080HCXIN
Dimensions - w x h x d Inches (mm)	38.8 x 69.6 x 40.9 (986 x 1,769 x 1,040)		32.4 x 78.8 x 40.2 (823 x 2,001 x 1,021)			34.7 x 71.1 x 40.2 (883 x 1,805 x 1,021)		31.8 x 64.7 x 36 (809 x 1,643 x 914)	
Product Weight (lbs/kg)	530 / 240	530 / 240	530 / 240	530 / 240	530 / 240	431 / 195	429 / 195	307 / 139	305 / 138
Installation Type	Indoor								
Storage Tank	119 Gallons					80 Gallons			
Min/Max Input (1,000 Btu/h)	30 / 398	30 / 398	30 / 398	30 / 398	30 / 320	15 / 199	15 / 160	15 / 199	15 / 160
Thermal Efficiency (TE)	95%					96%		95%	
Temperature Range	98°-185°F / 37-85°C								
First Hour Delivery @ 100 °F ΔT*** (gph/lph)	551 / 2086	551 / 2086	551 / 2086	551 / 2086	460 / 1741	317 / 1200	271 / 1026	290 / 1098	244 / 924
Recovery @ 100 °F ΔT (gph/lph)	468 / 1772	468 / 1772	468 / 1772	468 / 1772	376 / 1423	234 / 886	188 / 711	234 / 886	188 / 711

* Demand Duo 2 and 2V
 ** Demand Duo 2V vs. two 200 Btu tanks in cubic ft.
 *** Per test results from Rinnai testing lab based on storage volume and 70 percent usable hot water.
 **** ASME Tank ©2020 Rinnai America

The Next Generation in Hybrid Technology

Simplified Installation. Optimized Performance.
Unsurpassed Warranty.

The Demand Duo R-Series easily vents through existing 6" B-Vent, so you save installation time and costs. What's more, our patented technology delivers reliable performance, longer service life and lower total cost of ownership when compared to traditional atmospheric tanks.

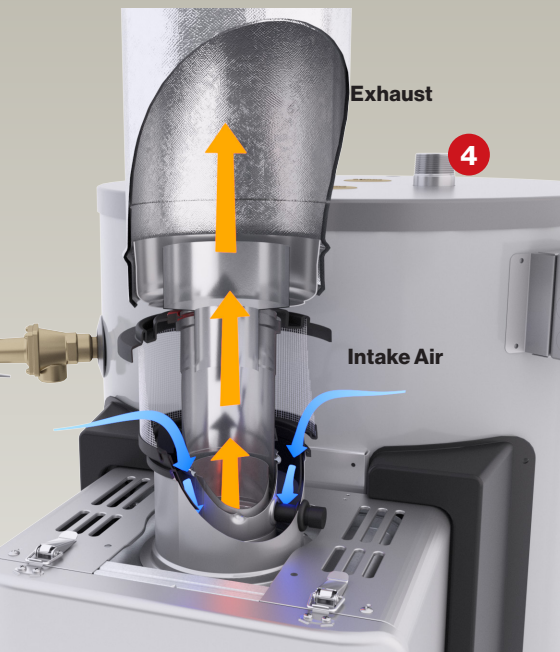

Installation Ease

- 1** New Pre-installed Intake Filter and Exhaust Connector for 6" Category 1 B-Vent
- 2** Fast Gas Connect with 36" Swivel Flex Line and pre-installed Drip Leg
- 3** Fast Power Connect with pre-installed J-Box and Duplex Outlet
- 4** New Cold Water Inlet available at the Top or Bottom of the Tank

Optimized Performance

- 5** New Integrated Pump Control
- 6** New Enhanced Temperature Recovery

Multiple Sizes

- 7** 80 or 119-Gallon Tank Options

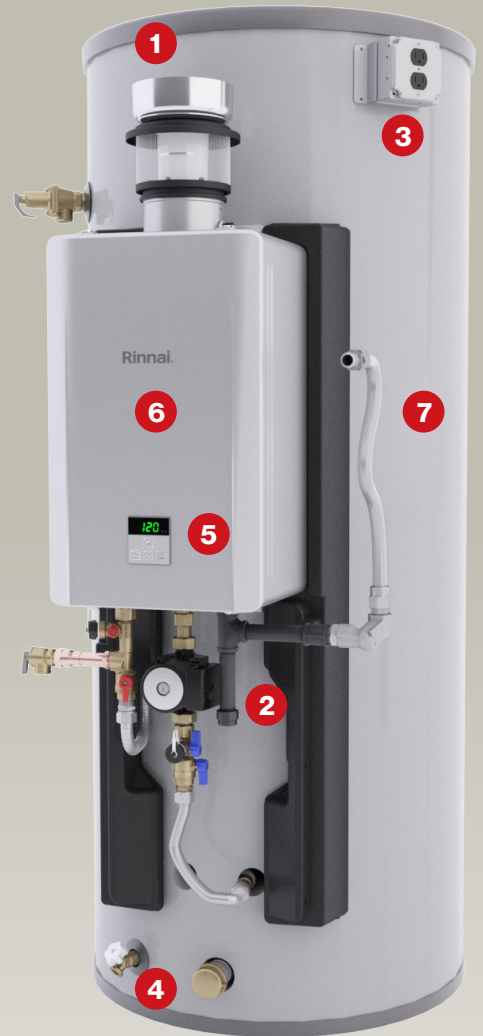

DuoSmart[®]
TANK TECHNOLOGY



Intake Filter Exhaust Connector



Pre-installed Electrical



3-Piece 6" B-Vent Accessory Kit Included

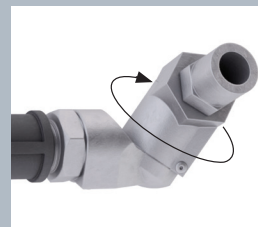



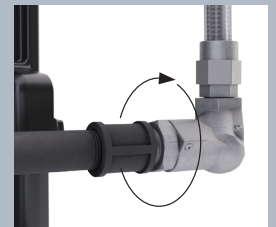

Two-way Gas Line Rotation for Easy Installation



Cost-Saving Reliability That Installs Easily.



Tankless 1st-hour: 276 gph

 <p>SAVE TIME – FACTORY-INSTALLED ELECTRICAL & GAS COMPONENTS</p>	 <p>SAVE MONEY – INSTALLS INTO 6" B-VENT</p>
 <p>FACTORY-INSTALLED GAS DIRT LEG</p>	 <p>360° GAS LINE ROTATION</p>

When you need a quick, simple replacement for a traditional atmospheric tank, Rinnai's Demand Duo R-Series Commercial Hybrid Water Heating System produces consistent, reliable hot water in a cost-saving package.

- Vents into existing 6" B-Vent
- Eliminates new vent runs
- Cuts cost of additional venting material
- No new ceiling, roof or wall penetrations
- Easy to install*, lighter than tanks



More Than
2X
THE WARRANTY
of Most Traditional Tanks

Unsurpassed 6 Years on the Tank*
8 Years on the Heat Exchanger
5 Years on Parts
2 Years on the Labor

* Versus 3 Year Warranty offered by most tank manufacturers

- High altitude approved to 5,400 ft.
- Certification System: AHRI, ANSI, CSA
- Wi-Fi capable

DEMAND DUO® R-SERIES SPECIFICATIONS | NON-CONDENSING MODELS

	Demand Duo® 100 GAL	Demand Duo® 80 GAL
		
Model	CHS199100REC	CHS19980REC
Part Number	CHS199100RECIN / CHS199100RECIP	CHS19980RECIN / CHS19980RECIP
Dimensions - w x h x d Inches (mm)	31.5 x 71.4 x 40.2 (800 x 1814 x 1020)	27.7 x 65.3 x 35.6 (703 x 1657 x 904)
Product Weight (lbs/kg)	364 / 165	331 / 150
Installation Type*	Indoor	Indoor
Storage Tank	119 / 450	80 / 303
Min/Max Input (1,000 Btu/h)	11.9 / 199	11.9 / 199
Thermal Efficiency (TE)*	80%	80%
Temperature Range	120°–180°F / 49°–82°C	120°–180°F / 49°–82°C
First Hour Delivery @ 100 °F ΔT* (gph/lph)	276 / 1045	249 / 942
Recovery @ 100 °F ΔT (gph/lph)	193 / 730	193 / 730

*Local, state, provincial, federal and national fuel gas codes must be adhered to prior to and upon installation.



Cold Water Inlet on Top Option



Common Vented Units

Rinnai Tankless Rack Systems™

A One-Stop Shop for the Water Heating Solutions of the Future

Make reliability, redundancy and flexibility key features in your customers' water heating solutions.

With Rinnai Tankless Rack Systems, your customers can harness all the benefits of tankless water heating technology, pre-assembled and ready to replace their existing water heating systems. Built with superior quality and reliability, Rinnai's Tankless Rack System™ (TRS) offers the perfect Btu upgrade for older domestic boiler units that require reheating storage tanks.

With four different tankless rack solutions, Rinnai offers customers the variety they need to achieve the perfect rack system for their needs.

- 1 Free-Standing Design Solution**
The perfect fit for hospitality, multi-family, industrial, schools, dorms and more.
- 2 Wall-Mounted Design Solution**
Created for food service, hospitality kitchens, laundries and zoned systems, this option can replace medium to large boilers.
- 3 Corner-Mounted Design Solution**
Perfect for food service, zoned systems and hospitality kitchens, the corner design replaces a wall unit when space is tight.
- 4 Custom Design Solution**
No matter your customer's needs, we can work with them and their business to craft the perfect rack system.

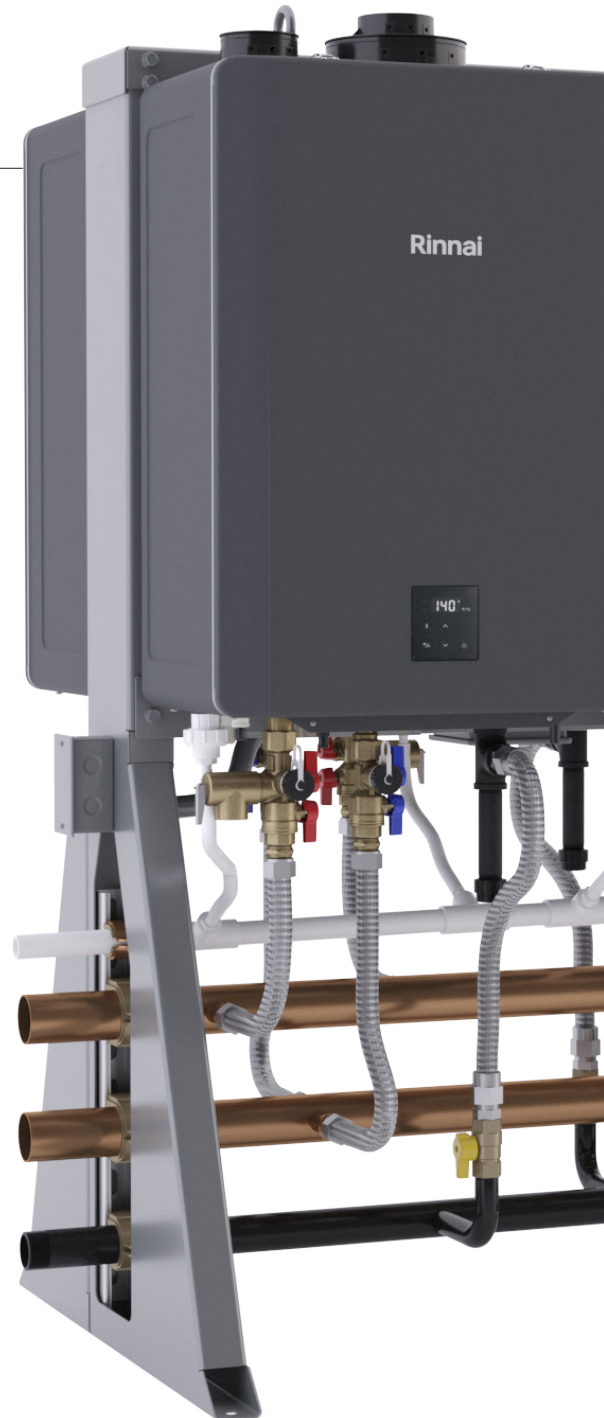

Rinnai Tankless Free-standing Rack

High Performance and Reliability Come Standard.



The Rinnai Tankless Free-standing Rack is the perfect replacement for domestic boilers.

The benefits of a Tankless Free-standing Rack:

- Provides built-in redundancy by banking individual Tankless Water Heaters to ensure your customer's hot water supply keeps flowing even if a unit is down
- Comes standard with the condensing CX199 Tankless Water Heater that boasts 97% thermal efficiency and a heat exchanger built for the demands of commercial applications
- Built with unsurpassed quality and comes with top-of-the-line technical support
- Wi-Fi Capable
- Flexible installation
 - Fits through standard 32" doorways and service elevator
 - Has various venting options, including PVC and the Rinnai Common Vent system
 - Can be mounted indoors or outdoors using natural gas or propane

Rinnai Tankless Wall-Hanging Rack

A Higher Level of Efficiency



Shipped fully assembled in a variety of configurations, new Rinnai Tankless Wall-Hanging Rack (TRW) arrives ready to install, and ready to impress.

A complete and fully modular solution, the TRW features a sturdy, pre-assembled rack with multiple Rinnai Tankless Water Heaters already mounted and connected to each other. Together, the units have enough capacity to suit commercial water heating requirements, replacing tank-style water heaters or domestic boilers with one simple, energy-efficient solution.

- TRW racks are stocked by distribution, making them perfect for emergency replacement
- Quick and easy installation with included wall-hanging bracket
- Lightweight aluminum frames
- TRW racks come with two to three tankless water heaters per rack, which can be combined with up to 24 units and provide up to 4.8 million Btu
- Indoor or outdoor installations
- Fits, fully assembled, through standard 32-inch doorways and on elevators
- Modulation technology with turn-down ratios of up to 312:1 to ensure hot water delivery and efficiency
- Use with or without storage tank and/or recirculation loop
- No ASME inspection required

The TRX Compact Wall-Mount System™

makes installation quick and simple



- Two CX199 Commercial Tankless Units
- Max/Min input rate of 398,000/15,200 Btu/hr
- 10.8 gpm Flow Rate at 70° rise
- Takes up minimal wall space
- Mounts over existing wall conditions with offset wall bracket
- Fully assembled on Frame with factory-tested manifolds
- Pre-installed Cascade Controls to link tankless units
- Available in Natural Gas; Propane Conversion Kit included
- Perfect for restaurant, hospitality and retail applications
- Assembled in Griffin, Georgia, USA
- Available with Optional Freestanding Rack Accessory

Preassembled TRX Compact Wall Mount System Saves Space, Saves Time, Saves Money



Available 3 TRX units to a pallet



160 lbs – Transport to the jobsite in a truck or van (no forklift required)



Fits easily onto a hand truck and through a 32" door



Take up ZERO floorspace to allow for other equipment or more storage

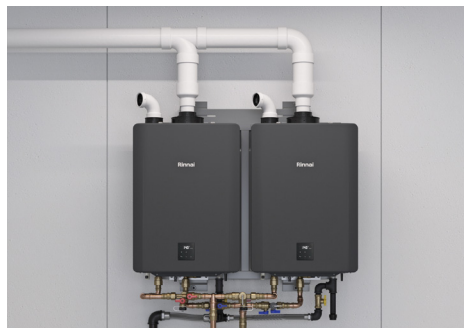

Compact and takes up minimal wall space



Mounts over existing cables, conduit, brackets, piping with included Offset Mount Bracket

Rinnai Tankless Rack System™ Benefits

Now you can harness all the benefits of tankless water heating technology, pre-assembled and ready to replace the boiler in your existing or planned boiler and storage tank domestic water heating system.

Built with superior quality and reliability, Rinnai's Tankless Rack System™ (TRS) offers the perfect BTU upgrade of an old-style domestic water boiler that is reheating storage tanks. On retro-fit applications, oftentimes you can keep your existing tank and pump and simply replace with the lower-cost and better-performing TRS.

The TRS installs in place of an old-style boiler and provides built-in redundancy by banking individual Tankless Water Heaters to ensure your hot water supply keeps flowing even if a unit is down. The TRS comes standard with our new condensing CX199 Tankless Water Heater that boasts 97% thermal efficiency and a heat exchanger built for the demands of commercial applications.

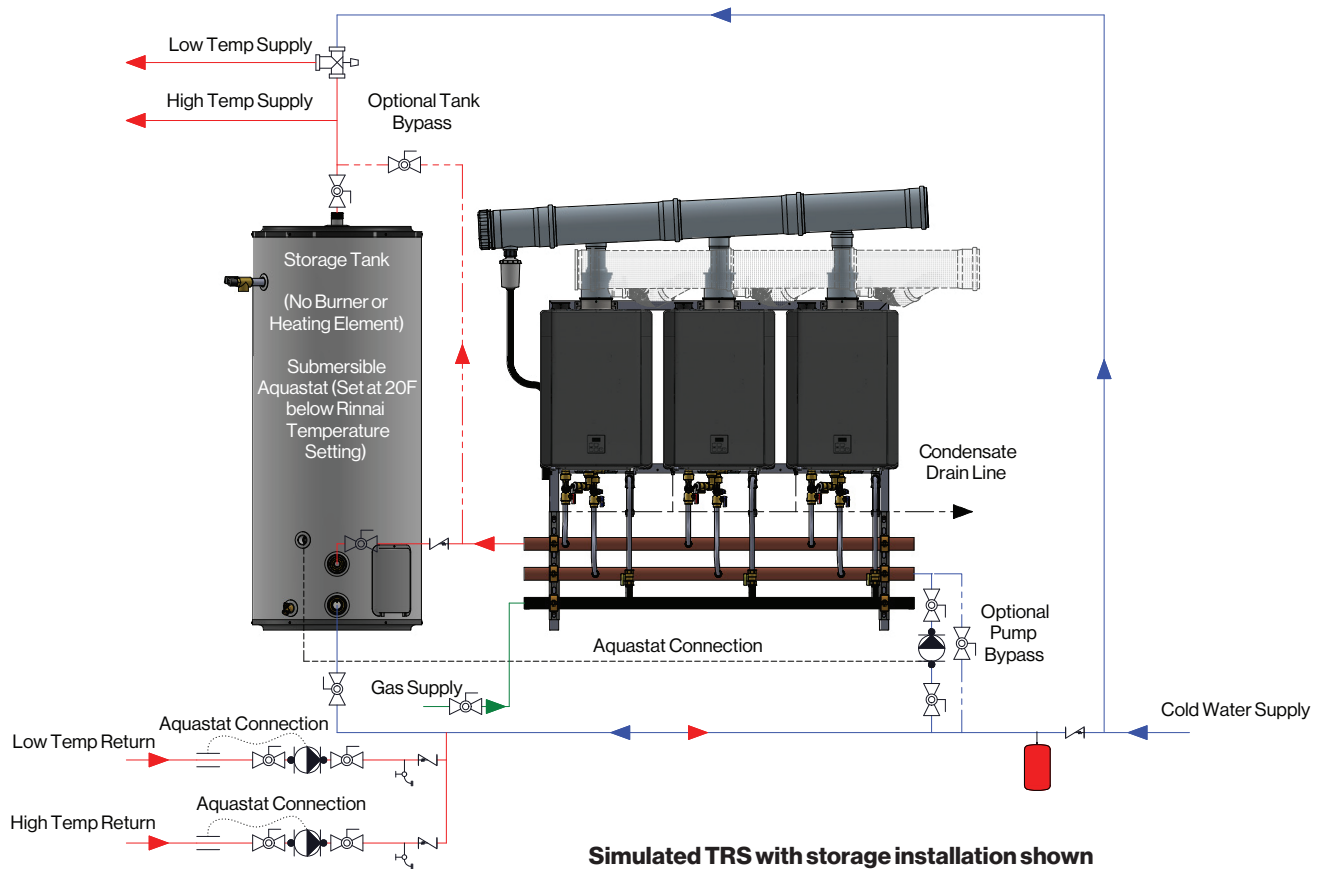

Flexible installation is another TRS strong suit. It fits through a standard 32" doorway, has various venting options including PVC and the Rinnai Common Vent system, and can be mounted indoors or outdoors, either floor-standing or wall-mount.

By offering a significantly lower upfront capital investment and reduced annual maintenance costs, the overall cost of ownership can be lower vs. the same BTU boiler. Couple that with the Rinnai reputation for unsurpassed quality and

technical support — plus the added benefit of having the Rinnai Commercial Solutions Team help with free sizing and application engineering — and the TRS is the business-friendly replacement for even the largest boilers.

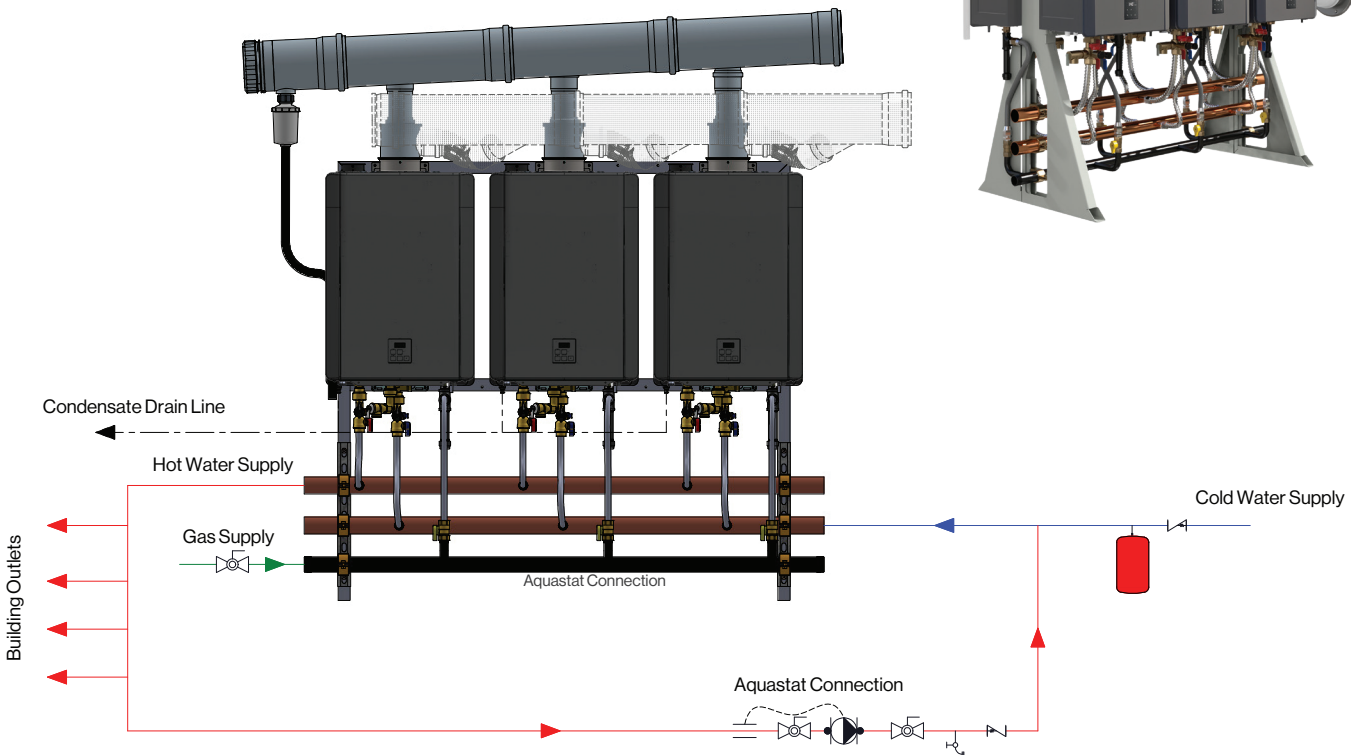

Simulated TRS with recirculation installation shown

Flexibility, durability and efficiency

SUPER-HIGH-EFFICIENCY (CONDENSING)



Model	CX199iN	CX160iN	CXP199iN	CXP160iN
Dimensions - w, h, d Inches (mm)	18.5x26.4x11.5 (470 x 670 x 290)	18.5x26.4x11.5 (470 x 670 x 290)	18.5x26.4x11.5 (470 x 670 x 290)	18.5x26.4x11.5 (470 x 670 x 290)
Weight (lbs / kg)	64 / 29	62 / 28	64 / 29	62 / 28
Installation Type	indoor / outdoor	indoor / outdoor	indoor / outdoor	indoor / outdoor
Storage Tank	No	No	No	No
Min./Max. BTU (NG)	15,000 / 199,000	15,000 / 160,000	15,000 / 199,000	15,000 / 160,000
Min./Max. BTU (LP)	15,000 / 199,000	15,000 / 160,000	15,000 / 199,000	15,000 / 160,000
Thermal Efficiency (TE) Ratings not certified by AHRI / Uniform Energy Factor (UEF) AHRI Certified	97% TE / .98 UEF	97% TE / .97 UEF	97% TE / .98 UEF	97% TE / .97 UEF
Temp. Range Commercial	98F-185F / 37C-85C	98F-185F / 37C-85C	98F-140F / 37C-60C	98F-140F / 37C-60C
Min. Activation Rate	0.4 GPM (1.5 L/min)	0.4 GPM (1.5 L/min)	0.4 GPM (1.5 L/min)	0.4 GPM (1.5 L/min)
Flow Rate (70° / 100° Temp. Rise)	5.5/3.9 GPM (20.8/14.7 L/min)	4.4/3.1 GPM (16.6/11.7 L/min)	5.5/3.9 GPM (20.8/14.7 L/min)	4.4/3.1 GPM (16.6/11.7 L/min)
Hot Water Flow Rate Range	0.26-9.8 GPM (.98-37.1 L/min)	0.26-9.8 GPM (.98-37.1 L/min)	0.26-9.8 GPM (.98-37.1 L/min)	0.26-9.8 GPM (.98-37.1 L/min)
Controller (standard)	MCC-91-2US	MCC-91-2US	MCC-91-2US	MCC-91-2US
Controllers (optional)	MC-91-2US	MC-91-2US	MC-91-2US	MC-91-2US
Ultra Low NOx	Yes			
Warranty (Commercial)*	Heat Exchanger: 8 yrs or 12,000 operation hours, whichever occurs first, All other parts: 5 yrs, Reasonable Labor: 1 yr			
Warranty (Residential)*	Heat Exchanger: 15 yrs or 12,000 operation hours, whichever occurs first, All other parts: 5 yrs, Reasonable Labor: 1 yr			
Valves Shipped in Box	No			
High Altitude Approved	Up to 10,200 ft (3109 M)			
Certifications	AHRI, ANSIZ21.10.3, CSA 4.3, and ENERGY STAR®			
Concentric	Yes	Yes	Yes	Yes
PVC/CPVC/PP	Yes	Yes	Yes	Yes
Common Vent	Yes	Yes	Yes	Yes
Room Air Common Vent	Yes	Yes	Yes	Yes
TRS/TRW Compatible	Yes	Yes	Yes	Yes
1/2" Gas Line Compatible***	Yes	Yes	Yes	Yes
Wi-Fi Capable	Yes	Yes	Yes	Yes
Integrated Pump	No	No	Yes	Yes

* For complete information and details regarding Rinnai's warranty, visit rinnai.us.

** To achieve temperatures over 140° F / 60° C, an MCC-91 commercial controller must be purchased separately.

*** For complete information on gas sizing for Rinnai Tankless Water Heaters, consult the Operation and Installation Manual.

HIGH-EFFICIENCY (NON-CONDENSING)







RE199i/RE199e	RE180i/RE180e	RE160i/RE160e	RE140i/RE140e	REP199i/REP199e	REP160i/REP160e
14.1x24.6x11.1 (357 x 626 x 283)	14.1x24.6x11.1 (357 x 626 x 283)	14.1x24.6x11.1 (357 x 626 x 283)	14.1x24.6x11.1 (357 x 626 x 283)	14.1x24.6x11.1 (357 x 626 x 283)	14.1x24.6x11.1 (357 x 626 x 283)
42 / 19	42 / 19	38 / 17	38 / 17	50 / 23	47 / 21
i=indoor e=outdoor	i=indoor e=outdoor	i=indoor e=outdoor	i=indoor e=outdoor	i=indoor e=outdoor	i=indoor e=outdoor
No	No	No	No	No	No
10,400 / 199,000	10,400 / 180,000	10,400 / 160,000	10,400 / 140,000	10,400 / 199,000	10,400 / 160,000
10,400 / 199,000	10,400 / 180,000	10,400 / 160,000	10,400 / 140,000	10,400 / 199,000	10,400 / 160,000
0.82 UEF	0.82 UEF	0.81 UEF	0.81 UEF	0.82 UEF	0.81 UEF
98F-185F / 37C-85C	98F-185F / 37C-85C	120F-140F / 49C-60C	120F-140F / 49C-60C	120F-185F / 49C-85C	120F-185F / 49C-85C
.13	.13	.26	.26	.26	.26
4.7/3.3 GPM (17.8/12.5 L/min)	4.3/3.0 GPM (16.3/11.3 L/min)	3.8/2.6 GPM (14.4/9.8 L/min)	3.3/2.3 GPM (12.5/8.7 L/min)	4.7/3.3 GPM (17.8/12.5 L/min)	3.8/2.6 GPM (14.4/9.8 L/min)
0.13-9.8 GPM (0.5-37 L/min)	0.13-8.5 GPM (0.5-32 L/min)	0.26-6.6 GPM (1.0-25 L/min)	0.26-5.3 GPM (1.0-20 L/min)	0.26-7.9 GPM (1.0-30 L/min)	0.26-6.6 GPM (1.0-30 L/min)
Integrated					
MC-601-BK, MC-601-W, MC-195T-US, MCC-601, control+TM			MC-601-BK, MC-601-W, MC-195T-US, control+TM		
Yes					
Limited 8-year on heat exchanger, 5-year on parts, 1-year on labor Register within 90 days and receive an additional 1 year of Labor coverage for FREE					
Limited 15-year on heat exchanger, 5-year on parts, 1-year on labor Register within 90 days and receive an additional 4 years of Labor coverage for FREE (\$250 value)					
No			Yes		
Up to 10,200 ft (3,109 M)					
AHRI, ANSI Z21.10.3, CSA 4.3					
Yes	Yes	Yes	Yes	Yes	Yes
No	No	No	No	No	No
No	No	No	No	No	No
No	No	No	No	No	No
No	No	No	No	No	No
No	No	No	No	No	No
Yes	Yes	Yes	Yes	Yes	Yes
No	No	No	No	Yes	Yes

TANKLESS RACK SYSTEM™ CONFIGURATIONS

WALL-HANGING

WALL-HANGING

					
Rack Model Number	TRX02CXIN	TRW02CXIN	TRW03CXIN	TRW02CXPIN	TRW03CXPIN
Tankless Model Number	(2x) CX199IN		(3x) CXP199IN	(2x) CXP199IN	(2x) CXP199IN, (1x) CX199IN
Thermal Efficiency (TE) Ratings not certified by AHRI / Uniform Energy Factor (UEF) AHRI Certified	97%TE / 98% UEF				
Number of Tankless Units	2	2	3	2	3
Max Input (BTU/h)	398,000	398,000	597,000	398,000	597,000
Min Input (BTU/h)*	15,200				
Shipping Dimensions - w x h x d inches (mm)	70 x 66 x 35 (1,778 x 1,676 x 889)				
Product Dimensions - w x h x d inches (mm)	44 x 54.8 x 14.1 (1,117 x 1,392 x 358)	44 x 54.8 x 14.1 (1,117 x 1,392 x 358)	65 x 58 x 14.1 (1,651 x 1,473 x 358)	44 x 54.8 x 14.1 (1,117 x 1,392 x 358)	65 x 58 x 14.1 (1,651 x 1,473 x 358)
Shipping Weight (lbs/kg)	363/165	452/205	379/172	460/209	387/176
Fully Assembled Weight (lbs/kg)	153/69	231/105	158/72	239/108	166/75
Gas Manifold (dia.) (in./mm)	1-1/2"/38mm	1-1/4"/32mm	1-1/4"/32mm	1-1/4"/32mm	1-1/4"/32mm
Water Manifold (dia.) (in./mm)	1"/25mm	2"/51mm	2"/51mm	2"/51mm	2"/51mm
Flow Rate @ 70° F ΔT (GPM/GPH)†	10.8/648	10.8/648	16.2/972	10.8/648	16.2/972
Flow Rate @ 100° F ΔT (GPM/GPH)†	7.6/456	7.6/456	11.4/684	7.6/456	11.4/684
Max. Current (Amperes)	8	8	12	8	12
Electrical Requirements	Ac 120 Volts - 60Hz				
Frame Material	Aluminum				
Water Manifold Material	Rigid Copper				
Water Branch Line (dia.)	3/4"				
Gas Manifold Material	Sch 40 Steel				
Gas Branch Line Material	PVC over CSST				
Warranty - Commercial**	Heat Exchanger: 8 yrs or 12,000 operation hours, whichever occurs first, All other parts: 5 yrs, Reasonable Labor: 1 yr				
Warranty - Residential**	Heat Exchanger: 15 yrs or 12,000 operation hours, whichever occurs first, All other parts: 5 yrs, Reasonable Labor: 1 yr				
High Alt. Approval	Yes				
PVC/CPVC	Yes				
Common Vent (Vertical, Horizontal and Side Wall Intake Vertical Exhaust)	Yes				
Room Air Common Vent (Vertical Exhaust)	Yes				
Room Air Common Vent (Horizontal Exhaust)	Yes				
CX199 Certifications	CSA				
Wi-Fi Capable	Yes				
Pre-Wired Power Outlet & Junction Box***	No				

* When using cascade controller (REU-MSB)

** For complete information and details regarding Rinnai's warranty, visit rinnai.us.

*** Pre-Wired Power Outlet and Junction Box is integrated on interior units only. † GPH represents flow rate delivered as GPH, not storage GPH.

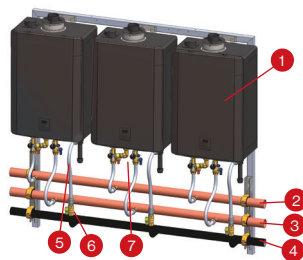

WALL-HANGING RACK

NO	DESCRIPTION	NO	DESCRIPTION
1	Rinnai Tankless Indoor or Outdoor Unit	5	¾" Dirt Leg
2	Manifold, Hot Water	6	¾" FNPT Brass Ball Valve – Gas
3	Manifold, Cold Water	7	Pressure Relief Valve (PRV)
4	Manifold, Gas		

TANKLESS RACK SYSTEM™ CONFIGURATIONS

FREE-STANDING RACKS

	FREE-STANDING, INLINE			FREE-STANDING, BACK TO BACK		
Rack Model Number	TRS02ILCXIN	TRS03ILCXIN	TRS03CXIN	TRS04CXIN	TRS05CXIN	TRS06CXIN
Tankless Model Number	CX199IN					
Thermal Efficiency (TE) Ratings not certified by AHRI / Uniform Energy Factor (UEF) AHRI Certified	97%TE / 98% UEF					
Number of Tankless Units	2	3	3	4	5	6
Max Input (BTU/h)	398,000	597,000	597,000	796,000	995,000	1,194,000
Min Input (BTU/h)*	15,200					
Shipping Dimensions - w x h x d inches (mm)	70 x 66 x 35 (1,778 x 1,676 x 889)			70 x 66 x 35 (1,778 x 1,676 x 889)		
Product Dimensions - w x h x d inches (mm)	47 x 55.6 x 31.1 (1,194 x 1,412 x 790)	65 x 55.6 x 19.3 (1,651 x 1,412 x 490)	47 x 55.6 x 31.1 (1,194 x 1,412 x 790)	47 x 55.6 x 31.1 (1,194 x 1,412 x 790)	65 x 55.6 x 31.1 (1,651 x 1,412 x 790)	65 x 55.6 x 31.1 (1,651 x 1,412 x 790)
Shipping Weight (lbs/kg)	416/189	497/225	490/222	562/454	658/298	731/332
Fully Assembled Weight (lbs/kg)	214/97	297/135	290/132	362/164	462/209	538/244
Gas Manifold (dia.) (in./mm)	1-1/4"/32mm	1-1/4"/32mm	1-1/4"/32mm	1-1/4"/32mm	1-1/2"/38mm	1-1/2"/38mm
Water Manifold (dia.) (in./mm)	2"/51mm	2"/51mm	2"/51mm	2-1/2"/63mm	2-1/2"/63mm	2-1/2"/63mm
Flow Rate @ 70° F ΔT (GPM/GPH)†	10.8/648	16.2/972	16.2/972	21.6/1,296	27/1,620	32.4/1,944
Flow Rate @ 100° F ΔT (GPM/GPH)‡	7.6/456	11.4/684	11.4/684	15.1/906	19/1,140	22.8/1,368
Max. Current (Amperes)	8	12	12	16	20	24
Electrical Requirements	Ac 120 Volts - 60 Hz					
Frame Material	Aluminum					
Water Manifold Material	Rigid Copper					
Water Branch Line (dia.)	3/4"					
Gas Manifold Material	Sch 40 Steel					
Gas Branch Line Material	PVC over CSST					
Warranty - Commercial**	Heat Exchanger: 8 yrs or 12,000 operation hours, whichever occurs first, All other parts: 5 yrs, Reasonable Labor: 1 yr					
Warranty - Residential**	Heat Exchanger: 15 yrs or 12,000 operation hours, whichever occurs first, All other parts: 5 yrs, Reasonable Labor: 1 yr					
High Alt. Approval	Yes					
PVC/CPVC	Yes					
Common Vent (Vertical, Horizontal and Side Wall Intake Vertical Exhaust)	Yes					
Room Air Common Vent (Vertical Exhaust)	Yes					
Room Air Common Vent (Horizontal Exhaust)	Yes					
CX199 Certifications	CSA					
Wi-Fi Capable	Yes					
Pre-Wired Power Outlet & Junction Box***	No					

* When using cascade controller (REU-MSB)

** For complete information and details regarding Rinnai's warranty, visit rinnai.us.

*** Pre-Wired Power Outlet and Junction Box is integrated on interior units only.

For Demonstration Purposes Only.

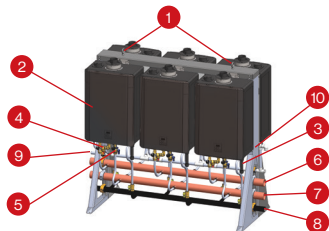

FREE-STANDING RACK

NO	DESCRIPTION	NO	DESCRIPTION
1	Lifting Eyebolt	6	Manifold, Hot Water
2	Rinnai Tankless Indoor or Outdoor Unit	7	Manifold, Cold Water
3	3/4" Dirt Leg	8	Manifold, Gas
4	3/4" FNPT Brass Ball Valve – Gas	9	Pre-Assembled Condensate Drain
5	Pressure Relief Valve (PRV)	10	Pre-Wired Power Junction Box

Rinnai Customized Solution

Get Rinnai tankless technology your way

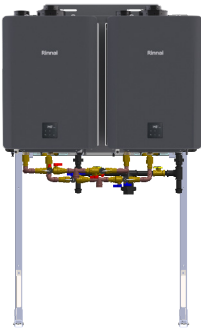

Rinnai is the industry leader in creating custom-engineered water heating solutions built around the needs of their customers. Using proven sizing methodologies, Rinnai's Application Engineering Center of Excellence is there to consult with you and provide the best total solution for your next project. Call them at **1-800-621-9419** or email at engineering@rinnai.us.



PERFORMANCE CHART FOR TANKLESS RACK SYSTEMS UTILIZING STORAGE

RECOVERY CAPACITY AND FIRST HOUR DELIVERED @ TEMPERATURE RISE (°F) WITH STORAGE TANK											
Rack System Configurations						60° F Temperature Rise		80° F Temperature Rise		100° F Temperature Rise	
WH qty.	Model	Max BTUH Input	Tank Size (Gal.)	Recovery Pump Size		Recovery GPH	First Hour Delivered (Gal.)	Recovery GPH	First Hour Delivered (Gal.)	Recovery GPH	First Hour Delivered (Gal.)
				GPM	Head (ft)						
2	TRW02 / TRW23 TRS02 / TRS23	398,000	100	10	30	772	842	578	648	463	533
			200				912		718		603
			300				982		788		673
3	TRW03 / TRS03 / TRS36	597,000	100	15	30	1,158	1,228	867	937	695	765
			200				1,298		1,007		835
			300				1,368		1,077		905
			400				1,438		1,147		975
4	2-TRW02 / TRS04 / TRS46	796,000	100	20	30	1,544	1,614	1,157	1,227	927	997
			200				1,684		1,297		1,067
			300				1,754		1,367		1,137
			400				1,824		1,437		2,207
5	TRW02 + / TRW03 / TRS05	995,000	200	25	30	1,930	2,070	1,447	1,587	1,158	1,298
			300				2,140		1,657		1,368
			400				2,210		1,727		1,438
6	TRW03 + / TRW03 / TRS06	1,194,000	200	30	30	2,316	2,456	1,736	1,876	1,389	1,529
			300				2,516		1,946		1,599
			400				2,596		2,016		1,669

Note: This chart should be used only when the existing or specified system is known. Select TRS model to the left. Use existing or specified storage tank with TRS selection. Reference chart above for recovery GPH performance. To calculate "First Hour Delivered" add 70% of existing or specified tank volume to recovery GPH. Multiple configurations available. Reference TRS Installation Manual. TRS models are free-standing units; TRW models are wall-mount units.

DEFINITIONS:

Tank size: capacity of water in gallons inside storage tank as stated by manufacturer

Recovery pump: pump that will circulate water from tank to TRS during recovery period

Recovery Flow Rate: flow rate in GPM at which volume inside tank is being recovered

Recovery GPH: the water heater's ability to replenish hot water as it's drawn from the tank

Recovery efficiency: the ratio of energy delivered to the water to the energy content of the fuel consumed by the water heater

First Hour Delivered (Gal): usable volume of water that can be drawn in one hour, determined using the following formula: First Hour Delivered (Gal) = Recovery GPH + tank capacity x 0.70

Temperature rise: temperature difference in °F between the TRS set point and the incoming water temperature

Venting to Meet Every Commercial Application

The Following Vent Options are Available:

- Direct Vent with Concentric Pipe*
- Direct Vent with Twin Pipe
- Common Vent
- Room Air

Now Including 2" Venting up to 65' Vent Runs

- Fewer Wall or Roof Penetrations
- Simplifies Handling and Installation
- Reduced Material Costs
- Easier Routing of Vents

1 DIRECT VENT (Concentric Pipe and Twin Pipe)

Concentric Pipe

Combustion air and exhaust vent directly through a single concentric connection. Hot exhaust exits through the interior tube, while combustion air enters through the outer layer.

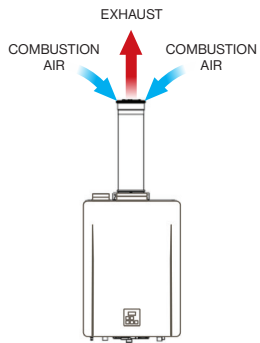

Twin Pipe

Combustion air and exhaust vent directly through separate penetrations.

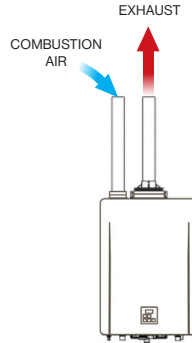

2 NON-DIRECT VENT (ROOM AIR AND EXTERNAL)

Room Air

Room air is used for combustion while exhaust vents to the outside.

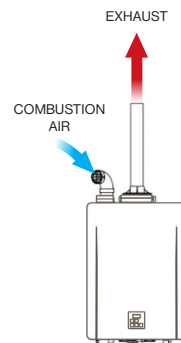

External (Outdoor)

Exterior models - no venting required.

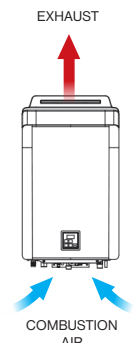

CONCENTRIC

Diameter	Equivalent Length	Termination
3"/5"	150' (46 m)	Vertical or Horizontal
2"/4"	65' (20 m)	Vertical or Horizontal

TWIN PIPE AND ROOM AIR

Diameter	Material	Equivalent Length	Termination
3"	PP, PVC, CPVC	150' (46 m)	Vertical or Horizontal
2"	PP, PVC, CPVC	65' (20 m)	Vertical or Horizontal

3 COMMON VENT (Indoor Units Only. Direct Vent and Non-Direct / Room Air Vent)

Direct Vent

Multiple water heaters sharing a combustion air header and a separate exhaust header that vents directly through separate penetrations to the outside.

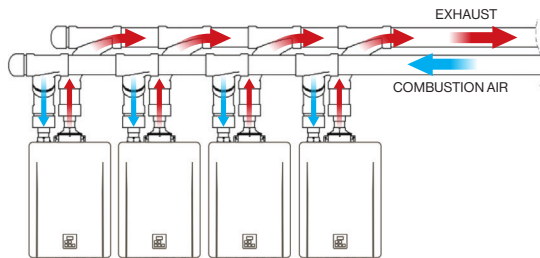

Non-Direct (Room Air) Vent

Multiple water heaters using room air for combustion while sharing an exhaust header that vents directly to the outside.

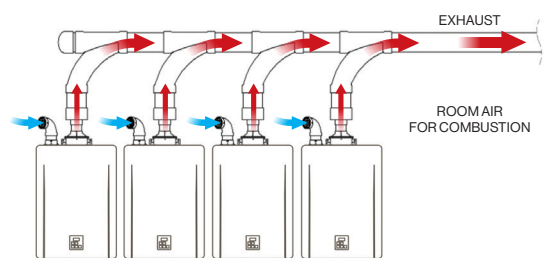

*HE+ Series tankless water heaters must use concentric venting with a metal exhaust pipe. Refer to the Installation and Operation Manual supplied with the HE+ Tankless Water Heater for venting options

VENT OPTIONS FOR CX SERIES TANKLESS WATER HEATERS

VENT OPTIONS	VENT MATERIAL		DIAMETER		MAX UNITS	MAXIMUM VENT LENGTH	
	Exhaust	Intake	Header	Vent			
Concentric Pipe	Polypropylene	Schedule 40 PVC		5"	1	150 ft	
				4"		65 ft	
Twin Pipe	Polypropylene* or Schedule 40 PVC/CPVC	Schedule 40 PVC/CPVC		3"	1	160 ft	
				2"		75 ft	
Common Vent	Polypropylene or Schedule 40 PVC/CPVC	Polypropylene or Schedule 40 PVC/CPVC		3"		2	75 ft
				4"		4	2-3 Units: 150ft 4 Units: 65 ft
				4"	6"	7	5-6 Units: 150ft 7 Units: 70 ft
				6"		8	2 - 8 units: 150 ft.
				6"		12	9-10 units: 90 ft 11-12 units: 41 ft.

*Twin Pipe Polypropylene venting is provided by Centrotherm through their own distribution network.

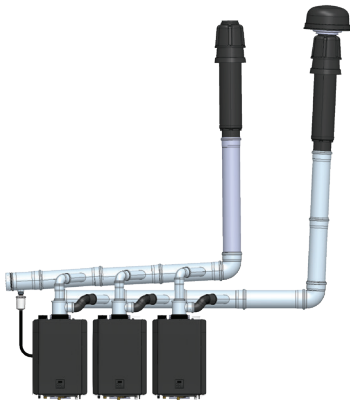

DIRECT VENT VERTICAL

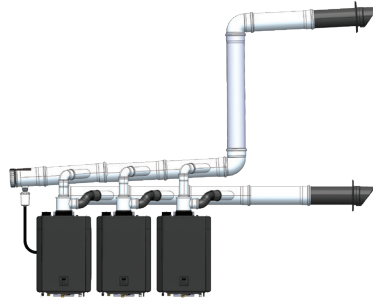

DIRECT VENT HORIZONTAL

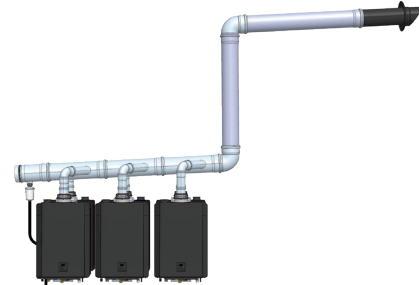

ROOM AIR WITH HORIZONTAL EXHAUST (NEW)

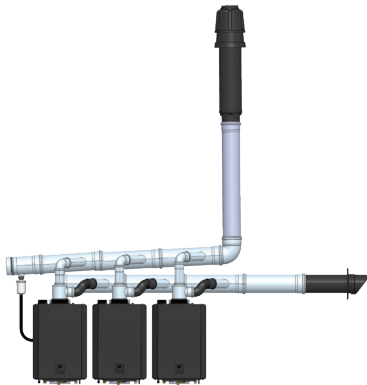

SIDE WALL INTAKE VERTICAL EXHAUST CX199 ONLY

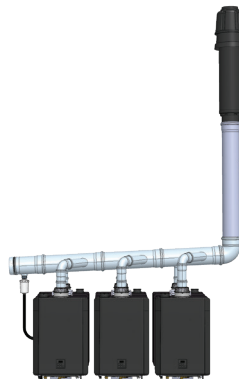

ROOM AIR COMMON VENT CONFIGURATION VERTICAL EXHAUST CX199 ONLY

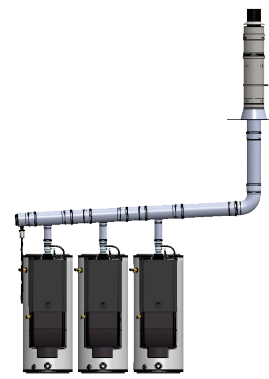

ROOM AIR COMMON VENT CONFIGURATION VERTICAL EXHAUST DEMAND DUO®

Common Venting | Direct Vent - Polypropylene

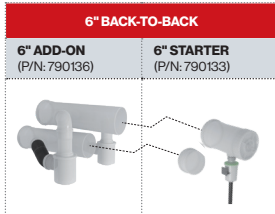
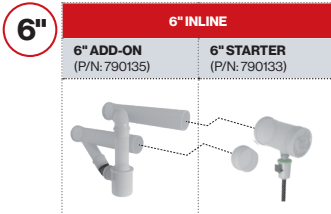
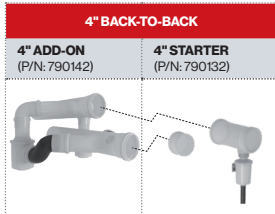
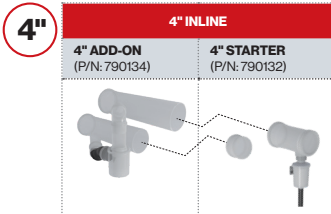

SAMPLE HORIZONTAL TERMINATION ASSEMBLY — DIRECT VENT

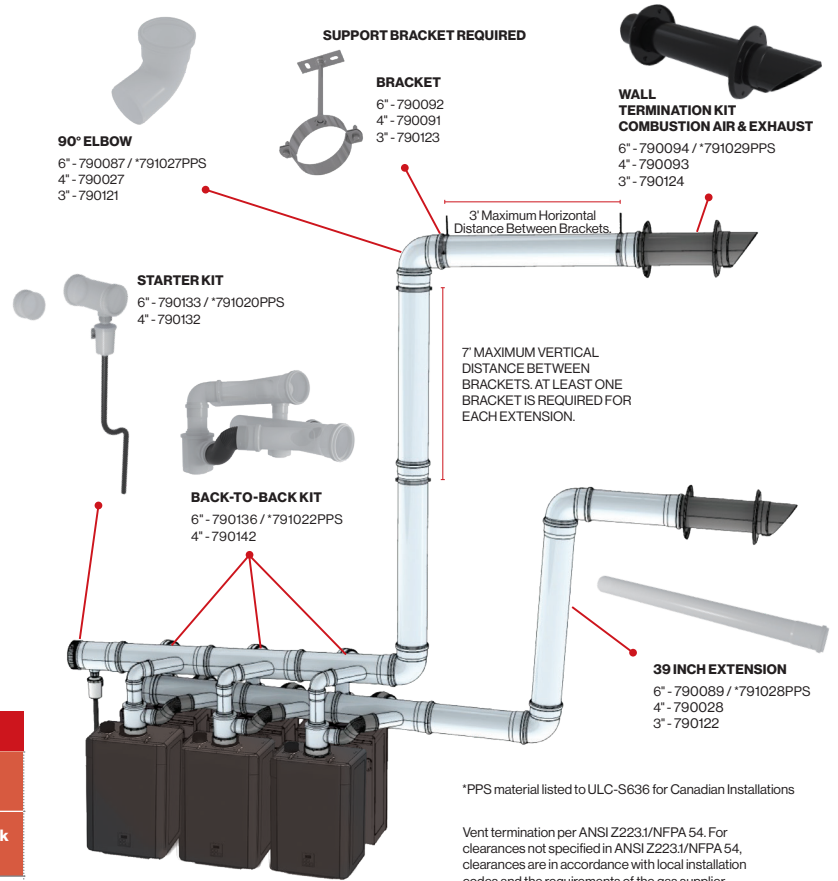

VENTING HEADER KIT MATRIX					
Qty of Tankless Units	Min. Vent Size	Qty of Starter Kits Needed	TRW/TRSIL MODELS	TRS MODELS	
			In Line Kits	In-Line Kits	Back-to-Back Kits
2	3"	1	2	0	1
3	4"	1	3	1	1
4	4"	1	4	0	2
5	6"	1	5	1	2
6	6"	1	6	0	3
7	6"	1	7	1	3
8	6"	1	8	0	4
9	6"	1	9	1	4
10	6"	1	10	0	5
11	6"	1	11	1	5
12	6"	1	12	0	6



Common venting
The epitome of streamlined installation

Use the Rinnai Common Venting System which uses Polypropylene PP – a more reliable venting material for the job and able to withstand exhaust temperatures up to 230° F.

- Clean, easy, cost effective installations that require less labor
- Fewer wall or roof penetrations
- Vent lengths up to 150' with 8 TWH units
- Easy push fit joints – no cement or glue required
- In-line or back-to-back installations; horizontal or vertical termination
- More venting options than ever before for indoor installations

Images are for illustrative purposes only. Refer to Installation Instructions for Polypropylene (PP) Common Venting for detailed instructions.

Common Venting | Room Air - Polypropylene

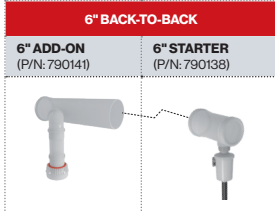
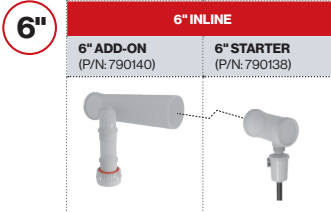
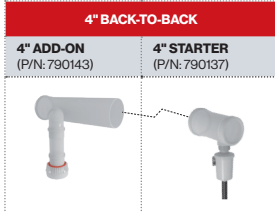
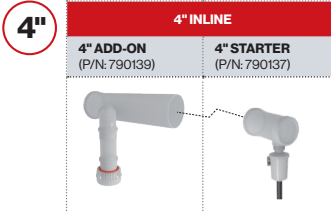

SAMPLE VERTICAL TERMINATION ASSEMBLY – ROOM AIR

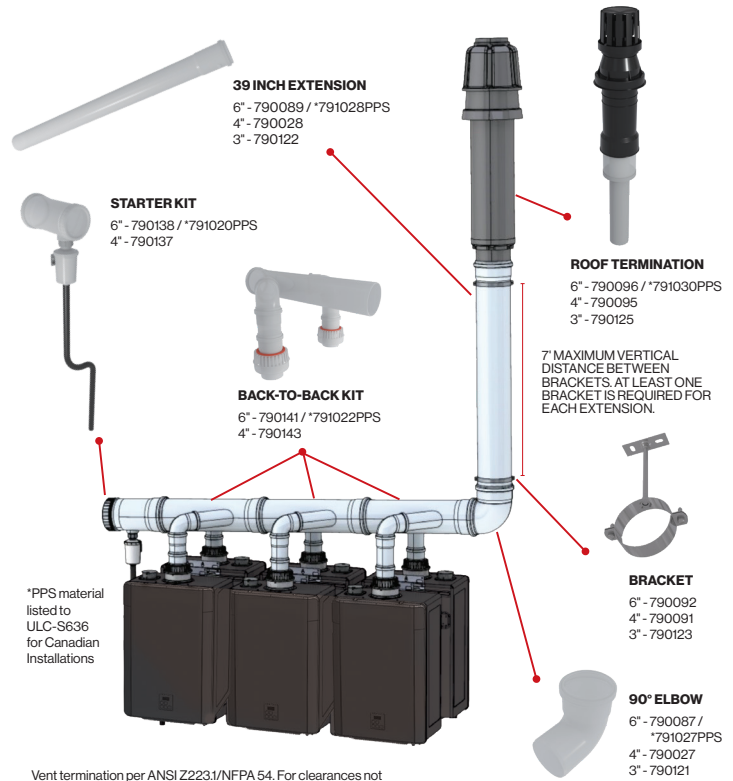

Vent termination per ANSI Z223.1/NFPA 54. For clearances not specified in ANSI Z223.1/NFPA 54, clearances are in accordance with local installation codes and the requirements of the gas supplier.



COMMON VENT MAXIMUM EQUIVALENT VENT LENGTHS

For the table below:

- Header is the main vent pipe into which several vents connect.
- Vent length is the distance from the end of the header to the vent termination.
- Maximum vent length starts at the end of the header system.
- Use 10 ft (3 m) as equivalent vent length for 90° elbows.
- For use with CX160 and CX199 (indoor) tankless water heaters only.

COMMON VENT MAXIMUM EQUIVALENT VENT LENGTH RINNAI COMMON VENT SYSTEM OR SCHEDULE 40 PVC / CPVC

Water Heater Model	# Water Heaters	Max System BTU/HR	Header Diameter			
			3"	4"		6"
			3" Vent Diameter	4" Vent Diameter	6" Vent Diameter	6" Vent Diameter
CX199iN and CXP199iN	2	398,000	65 ft			
	3	597,000		150 ft		
	4	769,000		65 ft	150 ft	
	5	995,000				150 ft
	6	1,194,000				
	7	1,393,000			70 ft	
	8	1,592,000				
	9	1,791,000				
	10	1,990,000				90 ft
	11	2,189,000				41 ft
	12	2,388,000				
	CX160iN and CXP160iN	2	320,000	90 ft	150 ft	
3		480,000		100 ft	150 ft	
4		640,000		65 ft		150 ft
5		800,000				
6		960,000				

Learn more at rinnai.us

COMMERCIAL COMMON VENTING COMPONENTS

3 IN. COMMERCIAL COMMON VENTING COMPONENTS (POLYPROPYLENE)

Part Number	Image	Description
790130	1	3 in. Kit Direct Vent for Corner Rack and In-line
790131	2	3 in. Kit Room air for Corner Rack and In-line
790120	3	Elbow 3 in. 45 (2x)
790121	4	Elbow 3 in. 90
790122	5	Extension 3 in. -39 in.
790123	6	Bracket 3 in. metal
790124	7	Wall terminal 3 in. plastic
790125	8	Roof terminal 3 in. plastic

4 IN. COMMERCIAL COMMON VENTING COMPONENTS (POLYPROPYLENE)

Part Number	Image	Description
790132	9	4 in. Common vent starter kit DV
790134	10	4 in. Common vent in-line 6 in. DV new valve
790137	11	4 in. Common vent starter kit room air
790142	12	4 in. Common Vent B2B DV Add on Kits
790143	13	4 in. Common Vent B2B room air add on kits
790139	14	4 in. Common vent in-line room air new valve
790026	3	Elbow 4 in. 45 (2x)
790027	4	Elbow 4 in. 90
790028	5	Extension 4 in. -39 in.
790088	5	Extension 4 in. -78 in.
790091	6	Bracket 4 in. metal
790093	15	Wall terminal 4 in. plastic
790095	16	Roof terminal 4 in. plastic
790097	17	Rain cap flue terminal 4 in.
780060	18	Rain cap air terminal 4 in.
790099	-	4 in. and 6 in. flashing 25-45 shingle + Spec. adapter
790101	19	4 in. and 6 in. flat roof flashing
790102	-	4 in. extension roof terminal kit plastic
790085	-	Adapter 6 in. - 4 in. air intake and exhaust
790104	-	Adapter 4 in. - 6 in. air intake and exhaust



COMMERCIAL COMMON VENTING COMPONENTS

6 IN. COMMERCIAL COMMON VENTING COMPONENTS (POLYPROPYLENE)

Part Number	Image	Description
790133	9	6 in. Common vent starter kit DV
790135	10	6 in. Common vent in-line 6" DV new valve
790136	20	6 in. Common vent B2B 6" DV new valve
790138	11	6 in. Common vent starter kit 6" room air
790140	14	6 in. Common vent in-line 6" room air new valve
790141	13	6 in. Common vent B2B 6 in. room air new valve
790086	3	Elbow 6 in. -45 (2x)
790087	4	Elbow 6 in. - 87
790089	5	Extension 6 in. - 39 in.
790090	5	Extension 6 in. - 78 in.
790092	6	Bracket 6 in. metal
790094	15	Wall terminal 6 in. plastic
790096	16	Roof terminal 6 in. plastic
790098	17	Rain cap flue terminal 6 in.
780061	18	Rain cap air terminal 6 in.
790103	-	6 in. extension roof terminal kit metal
790099	-	4 in. and 6 in. flashing 25-45 shingle + Spec. adapter
790101	-	4 in. and 6 in. flashing 25-45 shingle + Spec. adapter
790104	-	Adapter 4 in.-6 in. air intake and exhaust
790085	-	Adapter 6 in.-4 in. air intake and exhaust
For use in Canada		
791020PPS	-	6 in. COM. VENT START KIT DV PPS
791021PPS	-	6 in. COMMON VENT IN-LINE DV PPS
791022PPS	-	6 in. COMMON VENT B2B DV PPS
791023PPS	-	6 in. COM VENT START KIT ROOM AIR
791024PPS	-	6 in. COM. VENT IN-LINE ROOM AIR
791025PPS	-	6 in. COM. VENT B2B ROOM AIR PPS
791026PPS	-	ELBOW 6 in. - 45 (2X) PPS
791027PPS	-	ELBOW 6 in.-87 in. PPS
791028PPS	-	EXTENSION 6 in.-39 in. PPS
791029PPS	-	WALL TERMINAL 6 in. PLASTIC PPS
791030PPS	-	ROOF TERMINAL 6 in. PLASTIC PPS

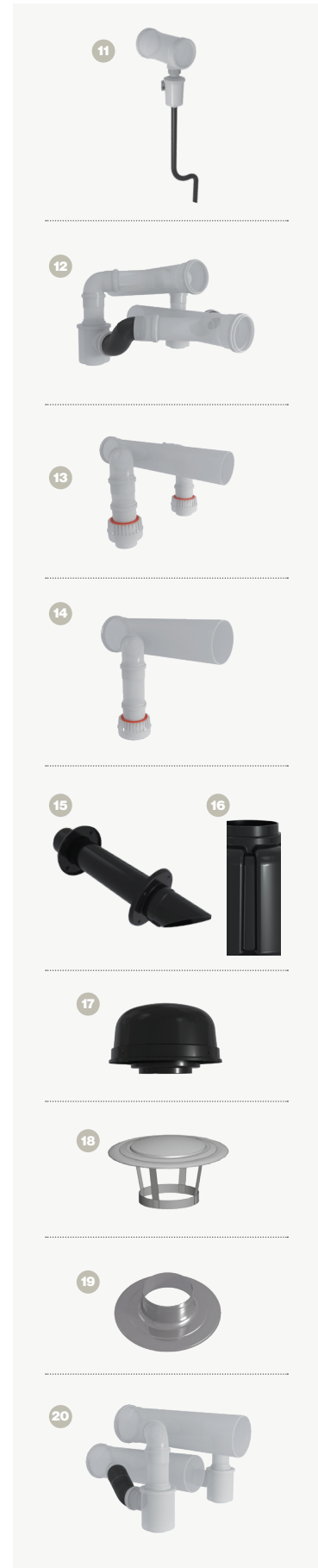

ACCESSORIES

CONTROLLER

Part Number	Image	Description	Temp range	Color
MCC-91-2W	1	Temperature Controller Commercial White	>140°F / 60°C	White

ACCESSORIES FOR DEMAND RECIRCULATION

Part Number	Image	Description	
Change to RWM200; Wireless Module	2	Control-R™ Wi-Fi Module	Attaches easily to the rinnai tankless water heater by a two-wire interface. All models.
Change to RPB200; Recirculation button for RWM200	3	Control-R™ Wi-Fi Push Button	Mounted near the point of use, like a kitchen faucet or bathroom sink, and operates like a recirculation system.
GTK15	5	Pump Timer Kit For Circ-Logic w/flange (SE+ /HE+)	Grundfos® pump for rinnai circ-logic™ enabled tankless water heaters.

OTHER

Part Number	Image	Description
804000074	6	Condensate Neutralizer KIT (SE Series)
104000059	-	Freeze Protection Solenoid Valve Kit for Outdoor Units in Cold Regions
105000195	7	Freeze Protection Surge Protector kiT
809000114	8	Refill, Condensate Neutralizer (All Models)
107000376	9	Grundfos UPS 26-99 (S)F Circulation Pump
107000377	10	Grundfos UPS 26-150 (S)F Circulation Pump
107000378	11	Grundfos UPS 40-160 FB Circulation Pump
109000733	12	TACO 265-3 Digital Timer Controller
109000734	13	Honeywell L6006C Aquastat Controller
109000735	14	Honeywell L6006A Aquastat Controller
109000736	15	1" NC Solenoid
109000737	16	1-1/2" NC Solenoid
103000067	17	Commercial Neutralization Tank w/ Media
103000068	-	Commercial Neutralization Replacement Media (40 lbs)
REU-PVA-4	-	Pressure Activated Valve
MIVK-T-LW	-	Plumbing Isolation Valve Kit, Compact design, Ease in Flushing



*Additional push button and motion sensors can be purchased separately to customize a recirculation system.

ACCESSORIES

CONNECTION CABLES

Part Number	Image	Description
REU-MSB-C1	18	Cable Connect VA, VB, Condensing, Excluding V53/R63 (SE Series / HE+ Series)
REU-MSB-C2	19	Cable For Connecting MSB-M Control Units (SE Series / HE+ Series)
REU-MSB-M	20	Multi-Unit Control (SE Series / HE+ Series)
REU-ECZ-C3; EZ Connect for RX / CX models	-	EZConnect™ Cable
REU-OPU3	-	BMS/Air Handler (Replaces 103000037)
103000037	-	Domestic Priority Switch for Hydronic Air Handler / Maintenance Indication Switch
REU-CSA-C1	21	Cascade Harness 3m
REU-CSA-C2	21	Cascade Harness 8m

PIPE ENCLOSURES

Part Number	Image	Description
PCD07-IB	22	Pipe cover (Commercial)
PCD07-IB-BP	23	Pipe cover bottom plate (Commercial)

2 in. VENTING COMPONENTS FOR USE WITH CX199

Part Number	Image	Description
184470NPP	24	2 in. Condensing Flex Termination Kit
222720NPP	25	2 in. Flex Connector
222721NPP	26	2 in. Flex Roll (41.5 ft)

BMS BUILDING MANAGEMENT SYSTEM COMPONENTS

Part Number	Image	Description
R-BMS100	27	BMS Gateway for Tankless and Indoor Usage
R-BMS-DD	27	BMS Gateway for Demand Duo® Interface
R-BMS-100-OE	27	BMS Gateway for Outdoor Usage
R-BMS101	28	Remote Tablet Interface for BMS

OTHER ACCESSORIES

Part Number	Image	Description
ST119	-	GRAY 119 Gallon STORAGE TANK
ST119A	-	GRAY 119 Gallon STORAGE TANK with ASME rating
107000470	-	Grundfos® UPS 26-99(S) F Circulation Pump with Check Valve and 3/4 in. Flange
R-UPS500A	-	Battery Backup system 500A

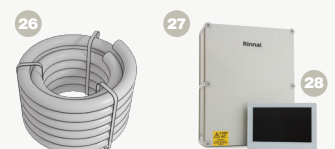
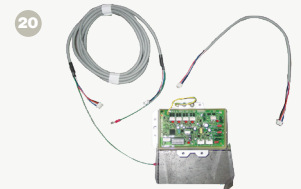



Rinnai®



Over 100 Years of Smart Comfort



Rinnai America Corporation Peachtree City, Georgia, USA

With headquarters in Japan and a global network of subsidiaries and sales offices, Rinnai has enhanced the way businesses and residences heat their water.

Dedicated to a smarter kind of comfort, our value-added products continue to stay in step with demands of a changing world.



Water Heating Solutions



Rinnai America in Griffin, Georgia, USA

Proudly assembling Tankless Water Heaters at our state-of-the-art factory located in Griffin, Georgia, USA

Rinnai established its US operations in 1974 and introduced Tankless Water Heating to the North American Market in 1999.

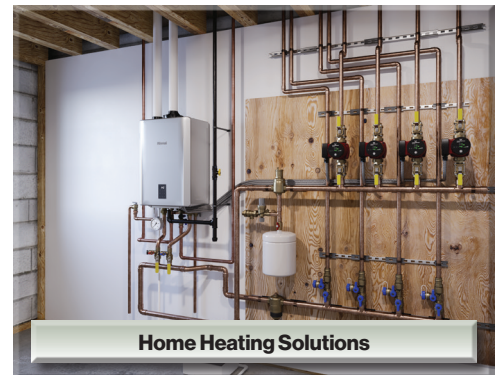

Home Heating Solutions



In 2018 Rinnai assembled its first tankless water heater in the United States in Griffin, Georgia. Our state-of-the-art facility was completed in 2021 with assembly of the new **RE•SERIES™ Non-Condensing Tankless Water Heaters** beginning in 2022.

Rinnai continues to make significant investments in expanding its operations and product portfolio.



Commercial Water Heating Solutions

Creating a healthier way of living.®

Learn more about Rinnai high-performance Tankless Water Heaters, Hybrid Water Heating Systems, Boilers, Vent-Free Fan Convectors, EnergySaver® Direct Vent Wall Heaters, Hydronic Air Handlers, Electric Heat Pump Water Heaters, and Accessories.

rinnai.ca

Rinnai America Corporation | 103 International Drive | Peachtree City, Georgia 30269 | rinnai.us | rinnai.ca | 1-800-621-9419



Official Water Heater of Tony Stewart Racing

