

## DESCRIPTION

The Halo Surface LED Downlight (SLD) incorporates WaveStream™ technology to create an ultra-low profile surface mounting luminaire with the performance and look of a traditional downlight. SLD6-1200 UNV series is designed for installation in many 4" x 2-1/8" deep square junction boxes. Accessory mounting kit allows retrofit in 5" and 6" IC and Non-IC recessed housings.\* Suitable for residential or commercial installations. Ideal for closets, storage areas, attics and basements. Compliant with NFPA® 70, NEC® Section 410.16 (A)(3) and 410.16 (C)(5).

Catalog #		Type
Project		
Comments		Date
Prepared by		

## SPECIFICATION FEATURES

### CONSTRUCTION

- Die cast aluminum trim ring, and die formed aluminum frame

### OPTICS

- WaveStream™ technology provides uniform luminance from a low profile flat lens
- AccuAim™ optics provide directional control for the "cone-of-light" beam distribution of a traditional downlight.
- Precision molded lens features high transmission polymer with UV stabilized protecting film

### DESIGNER TRIMS

#### Accessories (sold separately)

SLD designer trims are accessory rings that attach to the SLD for a permanent finish.\* Refer to SLD accessories specification sheet for details.

- White (Paintable)
- Satin Nickel
- Tuscan Bronze

\*SLD accessory trims attach with permanent adhesion and are not interchangeable after installation.

### ELECTRICAL JUNCTION BOX MOUNTING

- SLD may be used in compatible electrical junction boxes in direct contact with insulation including spray foam insulation
- Suitable for installation in many 4" x 2-1/8" deep square electrical junction boxes.
- Driver consumes 3 cubic inches of junction box.
- Compatible with other junction boxes with accessory SLD6EXT extension spacer ring.
- Surface mounting in a fire-rated ceiling using an appropriate electrical box offers a cost-effective alternative to fire-rated recessed housings

**Note:** Fire-rating is per the rating of the ceiling and applicable

junction box, not the SLD.

- Installer must ensure compatibility of fit, wiring and proper mounting in the electrical junction box. This includes all applicable national and local electrical and building codes.
- Proprietary Slot-N-Lock quick installation system for junction box installation
- T-bracket with Slot-N-Lock mounting tabs included

### OPTIONAL - RECESSED HOUSING MOUNTING

- Accessory SLD6ACCKIT required for mounting in 5" and 6" enclosed recessed housings
- May be installed in IC recessed housings in direct contact with insulation
- \* Note:** Not for use in recessed housings in direct contact with spray foam insulation. Refer to NEMA LSD 57-2013
- The SLD6 may be used with any 5 or 6 inch diameter recessed housing constructed of steel or aluminum with an internal volume that exceeds 107.9 in<sup>3</sup>.

### LED

- Linear LED arrays are integrated in trim perimeter
- Color Temperature: 2700K, 3000K, 3500K, 4000K
- CRI options: 80 and 90
  - 90 CRI can be used for California Title 24 compliance/certified to Title 20
  - 80 CRI can be used to comply with California Title 24 Non-Residential Lighting Controls as a LED luminaire.

### WARRANTY

Cooper Lighting provides a five year limited warranty on the SLD LED

### LED CHROMATICITY

- A tight chromaticity specification ensures LED color uniformity, sustainable Color Rendering Index (CRI) and Correlated Color Temperature (CCT) over the useful life of the LED
- LED chromaticity of 3 SDCM exceeds ENERGY STAR® color standards per ANSI.
- 90 CRI model features high color performance with R9 greater than 50
- Every Halo LED is quality tested, measured, and serialized in a permanent record to register lumens, wattage, CRI and CCT.
- Halo LED serialized testing and measurement ensures color and lumen consistency on a per-unit basis, and validates long-term product consistency over time

### ELECTRICAL CONNECTIONS Junction Box

- Compatible with 4" x 2-1/8" deep square boxes
- Supply Wire Adapter with LED quick connector included
- LED connector is a non-screwbase luminaire disconnect for tool-less installation

### Optional - Recessed Housings

- Accessory SLD6ACCKIT required.
- LED connector is compatible with Halo 5" H550 Series and 6" H750, H2750 Series LED Housings
- LED Connector meets California Title-24 high-efficacy luminaire standard as a non-screw base



## SLD6 1200 UNV Series

### Universal Voltage

#### SLD6128xxWHUNVJB

80CRI

2700K, 3000K, 3500K, and 4000K

#### SLD6129xxWHUNVJB

90CRI

2700K, 3000K, 3500K, and 4000K

### 6" Surface LED Downlight

### High Lumen 1200 Series Universal Voltage 120V-277V

Suitable for ceiling or wall electrical junction boxes

### ENERGY DATA

	80 CRI	90 CRI
Lumens (4000K models)	1215	1000
Input Voltage	120V-277V	120V-277V
Frequency	50/60 Hz	50/60 Hz
Input Current	0.12 A	0.12 A
Input Power	14.8 W	14.8 W
Efficiency (4000K models)	82 lm/W	68 lm/W
THD	≤ 20%	
Power Factor	≥ 0.90	
T Ambient	-30 - +40°C	
Sound Rating	Class A	

### NOMENCLATURE

#### SLD612830WHUNVJB

612 = 6" SLD 1200 Series

8 = >80 CRI

30 = 3000K

WH = Matte White

UNV = Universal Voltage 120V-277V

JB = Junction Box Kit only

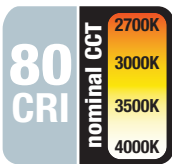

Refer to ENERGY STAR® Certified Products List. Can be used to comply with California Title 24 Non-Residential Lighting Controls requirements as a LED Luminaire.



Refer to ENERGY STAR® Certified Products List. Can be used to comply with California Title 24 High Efficacy requirements. Certified to California Title 20 Appliance Efficiency Database.

**LED DRIVER**

- Driver is a 120V-277V universal voltage input, high efficiency, dimmable electronic power supply providing DC power to the LED arrays
- Driver features high power factor, low THD, and has integral thermal protection in the event of over temperature or internal failure
- Driver is replaceable if it should be required
- If dimming is not required the fixture may be operated from a switch

**DIMMING - PHASE CONTROL**

- Designed for continuous dimming capability to nominally 5% with many 120V Leading Edge (LE) and Trailing Edge (TE) Phase Control dimmers. (Dimmers with low end trim adjustment offer greater assurance of achieving 5% level.)
- Consult dimmer manufacturer for compatibility and conditions of use. (Note some dimmers require a neutral in the wallbox.)

**DIMMING - 0-10V**

- Dimmable to 10% in typical operation with compatible 0-10V DC low voltage dimmers.

- 0-10V DC dimmers operate using two low voltage dimming wires (color coded violet and gray). The low voltage dimming wires are separate from the 120V AC or 277V AC power.
- Switching on/off is controlled via the line voltage (120V AC or 277V AC) power, and dimming is controlled via the 2-wire 0-10V DC low voltage wiring.

**COMPLIANCE**

- cULus Listed ceiling and wall
- cULus Damp Location listed ceiling and wall
- cULus Wet Location Listed, ceiling only (shower rated)
- Suitable for use in closets, compliant with NFPA® 70, NEC® Section 410.16 (A)(3) and 410.16 (C)(5)
- SLD may be used in compatible electrical junction boxes in direct contact with insulation including spray foam insulation
- With accessory SLD6ACCKIT, may be installed in IC recessed housings in direct contact with insulation (Not for use in recessed housings in direct contact with spray foam insulation. Refer to NEMA LSD 57-2013)

- EMI/RFI: meets FCC 47CFR Part 15 Class B limits, and is suitable for use in residential and commercial installations
- Airtight certified per ASTM E283 (not exceeding 2.0 CFM under 75 Pascals pressure difference)
- 90 CRI: Can be used to comply with California Title 24 High Efficacy requirements. Certified to California Title 20 Appliance Efficiency Database.
- 80 CRI: Can be used to comply with California Title 24 Non-Residential Lighting Controls requirements as a LED luminaire.
- Can be used for International Energy Conservation Code (IECC) and Washington State Energy Code high efficiency luminaire compliance
- ENERGY STAR® certified luminaire - consult ENERGY STAR® Certified Product List
- Contains no mercury or lead and RoHS compliant.
- Photometric testing in accordance with IES LM-79
- Lumen maintenance projections in accordance with IES LM-80 and TM-21



**SLD6 1200 UNV Series**

**Universal Voltage**

**SLD6128xxWHUNVJB**

80CRI

**2700K, 3000K, 3500K, and 4000K**

**SLD6129xxWHUNVJB**

90CRI

**2700K, 3000K, 3500K, and 4000K**

**6" Surface LED Downlight**

**High Lumen 1200 Series Universal Voltage 120V-277V**

**Suitable for ceiling or wall electrical junction boxes**

**DIMENSIONS**

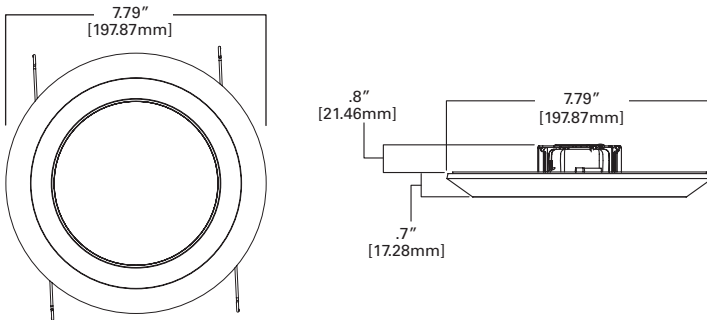

**ORDERING INFORMATION**

**SAMPLE NUMBER:** SLD612927WHUNVJB SLD6TRMSN

**Junction Box Installation:** Order junction box separately, as supplied by others, to complete installation.

**Recessed Installation:** Order Halo recessed housing separately to complete installation.

Models	Color Rendering Index	Color Temperature (CCT)	Finish	Voltage	Junction Box
SLD612= 6" Surface LED Downlight, 1200 Series	8=80 CRI 9=90 CRI	27=2700K 30=3000K 35=3500K 40=4000K	WH=White	UNV=Universal Voltage 120V-277V	JB=Junction Box Kit only

**Accessories**

**Designer Trims**

- Fit over the SLD for a designer finish
- SLD6TRMSN=6" SLD Satin Nickel
- SLD6TRMTBZ=6" SLD Tuscan Bronze
- SLD6TRMWH=6" SLD White (paintable)

\*SLD accessory trims attach with permanent adhesion and are not interchangeable after installation

**J-Box Spacer Extension Ring**

- Add 15/16" depth when SLD driver cannot fit into installed junction box
- SLD6EXT=6" Surface LED J-Box Extender, 9.5" O.D.

**RAD Adapters**

When junction box is mounted flat on a ceiling or beam surface (not recessed in ceiling)

- SLD6RAD=6" SLD Round Surface J-Box Adapter, 7.92" O.D. (for 4-inch round or octagon junction boxes.)
- SLD6SADPLT=6" SLD Square Surface J-Box Adapter Plate (For 4-inch square junction boxes, use with SLD6RAD.)

**Hardware Kits**

- SLD6ACCKIT=6" Accessory Parts Replacement Kit (Screwbase adapter, torsion springs, friction blades)
- SLD6BRKT=6" Junction Box Bracket & Screws

Refer to SLD Accessories specification sheet for further information.

**COMPATIBLE WITH EATON'S CROUSE-HINDS 4" SQUARE JUNCTION BOXES**



**TP450**  
for non-metallic cable  
4" x 4" x 2-1/8"  
(102mm x 102mm x 54mm)



**TP431†**  
for metal clad cable  
4" x 4" x 2-1/8"  
(102mm x 102mm x 54mm)

- **TP450** - for non-metallic cable
- **TP431** - for metal clad cable
- UL Listed
- Suitable for two-hour fire-rated ANSI/UL 263 when properly installed in a fire-rated ceiling or wall
- Refer to [www.crouse-hinds.com](http://www.crouse-hinds.com)

†UL approved for use with aluminum interlocking grounding metal clad cable, Type MCIA (Southwire MCAP™). MCAP™ is a registered trademark of Southwire Company.

**COMPATIBLE WITH 4" SQUARE JUNCTION BOXES\***



**4" square deep steel box**  
4" x 4" x 2-1/8"  
(102mm x 102mm x 54mm)

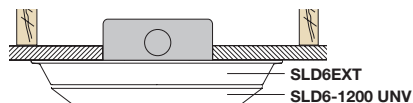

Compatible with other boxes when used with SLD6EXT extension spacer ring.

Surface mounting in a fire-rated ceiling using an appropriate electrical box offers a cost-effective alternative to fire-rated recessed housings.

**Note:** Fire-rating is per the rating of the ceiling and applicable junction box, not the SLD.

\*This is a representative list of compatible junction boxes only. Information contained in this literature about other manufacturers' products is from published information made available by the manufacturer and is deemed to be reliable, but has not been verified. Eaton makes no specific recommendation on product selection and there are no warranties of performance or compatibility implied. Installer must determine that site conditions are suitable to allow proper installation of the SLD mounting bracket in the box.

**PRODUCT DATA**

Cat No.	CRI	CCT	Lumens	Power (W)	LPW
SLD612827WHUNVJB	80	2700	1100	14.8	74
SLD612830WHUNVJB	80	3000	1150	14.8	78
SLD612835WHUNVJB	80	3500	1200	14.8	81
SLD612840WHUNVJB	80	4000	1215	14.8	82
SLD612927WHUNVJB	92	2700	880	14.8	59
SLD612930WHUNVJB	92	3000	925	14.8	63
SLD612935WHUNVJB	92	3500	965	14.8	65
SLD612940WHUNVJB	92	4000	1000	14.8	68

Performance values are presented as typical for the model(s) indicated. Field results may vary.

LIGHTING FACTS®

SLD612827WHUNVJB - 80 CRI

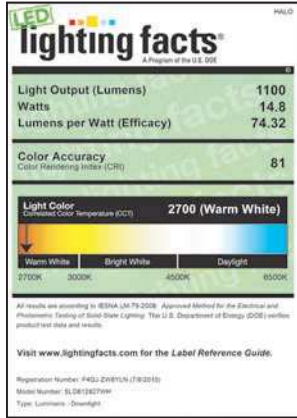

SLD612830WHUNVJB - 80 CRI

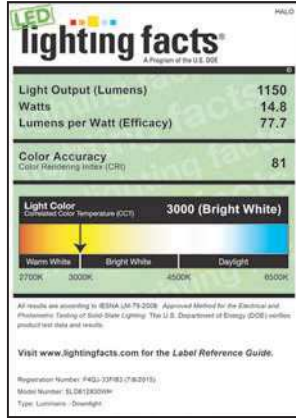

SLD612835WHUNVJB - 80 CRI

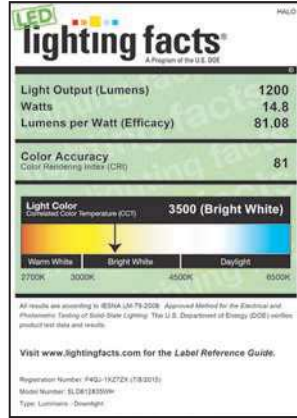

SLD612840WHUNVJB - 80 CRI

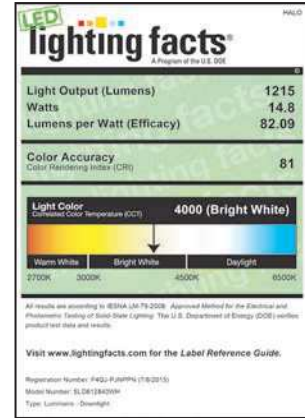

SLD612927WHUNVJB - 90 CRI

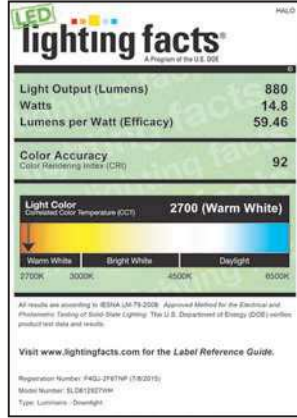

SLD612930WHUNVJB - 90 CRI

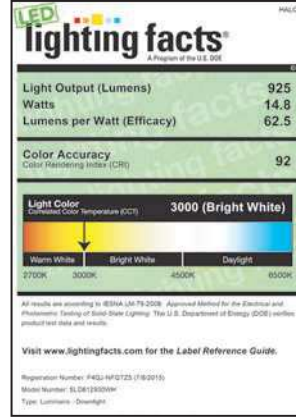

SLD612935WHUNVJB - 90 CRI

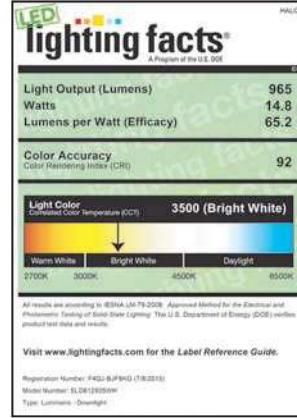

SLD612940WHUNVJB - 90 CRI

