

EVOLVE

EPTT Town & Country LED Post Top



Project Name _____
Date _____ Type _____
Notes _____

The **Evolve**® LED Post Top Town & Country (EPTT) offers energy efficiency and quality of light in a classic look and style. The advanced LED optical system provides improved horizontal and vertical uniformity, reduced glare and improved lighting control.

CONSTRUCTION

Housing:	Die-cast aluminum housing with traditional lantern design. Cupola compatible with C136.41-2010 PE's, Shorting Caps and LightGrid Nodes
Refractors:	Acrylic, Polycarbonate, None/Open
Lens:	Impact resistant UV resistant polymer
Paint:	Corrosion resistant polyester powder paint, minimum 2.0 mil thickness Standard = Black, Dark Bronze RAL & custom colors available
Weight:	14 - 18 lbs (6.2 - 8 kg)

OPTICAL SYSTEM

Lumens:	2,070-7,970
Distribution:	Symmetric Asymmetric
Efficacy:	72-130
CCT:	2700K, 3000K, 4000K, 5000K
CRI (Min):	≥70

ELECTRICAL

Input Voltage:	120-277V
Input Frequency:	50/60Hz
Power Factor:	≥ 90% at rated watts
Total Harmonic Distortion:	≤ 20% at rated watts

SURGE PROTECTION*

Standard	Optional
10kV/5kA	Secondary 10kV/5kA (R Option)

*Per ANSI C136.2-2015

LUMEN MAINTENANCE

Projected Lxx per IES TM-21-11 at 25°C

Distribution	LXX(10K) @ Hours		
	25,000 HR	50,000 HR	60,000 HR
02, 03	L99	L99	L98
04, 05, 06, 07	L96	L91	L89

Note: Projected Lxx based on LM80 (≥ 10,000 hour testing). Accepted Industry tolerances apply to initial luminous flux and lumen maintenance measurements.

AMBIENT TEMPERATURE FACTOR

Ambient Temp (°C)	Initial Flux Factor	Ambient Temp (°C)	Initial Flux Factor
10	1.02	30	0.99
20	1.01	40	0.98
25	1.00	50	0.97

RATINGS

Operating Temperature:	-40°C to 50°C (Optical Code 02-06) -40°C to 40°C (Optical Code 07)
Vibration:	3G per ANSI C136.31-2010
LM-79:	Testing in accordance with IES Standards

CONTROLS

Dimming:	Standard - 0-10V Optional - DALI (Option U)
Sensors:	Photo Electric Sensors (PE) available LightGrid Compatible

WARRANTY

5 Year (Standard)

10 Year (Optional)



Not all product variations listed on this page are DLC qualified. Visit www.designlights.org/search to confirm qualifications.

Project Name _____

Date _____ Type _____

Notes _____

EPTT 02

PROD. ID	GEN	VOLTAGE	OPTIC CODE	DISTRIBUTION	REFRACTOR	CCT	CONTROLS PER ANSI C136.41	MOUNTING	COLOR	OPTIONS
E = Evole	02	0 = 120-277	02	A = Symmetric	A = Acrylic	27 = 2700K ¹	A = ANSI C136.41 7-Pin PE Receptacle ²	P = Pole Mounted	BLCK = Black	L = Tool-Less Entry
P = Post Top			03	B = Asymmetric	P = Polycarbonate	30 = 3000K ¹	D = ANSI C136.41 7-Pin PE Receptacle w/ Shorting Cap		DKBZ = Dark Bronze	P06 = Prewire with 6 ft of 14/3 Cable
TT = Town & Country Traditional			04		N = None ¹	40 = 4000K	E = ANSI C136.41 7-Pin PE Receptacle w/ non Dimming PE			R = Secondary 10kV/5kA
			05			50 = 5000K				U = DALI Programmable ²
			06							Y = Coastal Finish ³
			07							XXX = Special Options

¹ Select for IDA Approved Units

² Compatible with LightGrid Nodes

³ Recommended for installations within 750 feet of coast. Lead time varies, check with factory.

Project Name _____

Date _____ Type _____

Notes _____

LUMEN OUTPUT	DIST. CODE	DESCRIPTION	REFRACTOR CODE	TYPICAL INITIAL LUMENS			WATTAGE 120-277V	BUG RATINGS		
				2700K	3000K	4000K/5000K		2700K	3000K	4000K/5000K
02	A	Symmetric	A	2600	2810	2930	25	B1-U3-G2	B1-U3-G2	B1-U3-G2
03	A	Symmetric	A	3070	3310	3450	29	B2-U3-G2	B2-U3-G2	B2-U3-G2
04	A	Symmetric	A	4230	4560	4760	41	B2-U3-G2	B2-U3-G2	B2-U3-G2
05	A	Symmetric	A	5150	5560	5790	50	B2-U3-G3	B2-U3-G3	B2-U4-G3
06	A	Symmetric	A	5710	6160	6410	56	B2-U4-G3	B2-U4-G3	B3-U4-G3
07	A	Symmetric	A	6960	7500	7820	72	B3-U4-G3	B3-U4-G3	B3-U4-G3
02	B	Asymmetric	A	2430	2630	2730	25	B1-U3-G2	B1-U3-G2	B1-U3-G2
03	B	Asymmetric	A	2870	3100	3220	29	B1-U3-G2	B1-U3-G2	B1-U3-G2
04	B	Asymmetric	A	3950	4270	4440	41	B1-U3-G3	B1-U3-G3	B1-U3-G3
05	B	Asymmetric	A	4810	5190	5410	50	B1-U4-G3	B2-U4-G3	B2-U4-G3
06	B	Asymmetric	A	5330	5750	5990	56	B2-U4-G3	B2-U4-G3	B2-U4-G3
07	B	Asymmetric	A	6500	7010	7300	72	B2-U4-G3	B2-U4-G3	B2-U4-G3
02	A	Symmetric	P	2070	2230	2330	25	B1-U3-G1	B1-U3-G1	B1-U3-G1
03	A	Symmetric	P	2440	2630	2740	29	B1-U3-G1	B1-U3-G2	B1-U3-G2
04	A	Symmetric	P	3370	3630	3780	41	B2-U3-G2	B2-U3-G2	B2-U3-G2
05	A	Symmetric	P	4100	4420	4600	50	B2-U3-G2	B2-U4-G2	B2-U4-G2
06	A	Symmetric	P	4540	4900	5100	56	B2-U4-G2	B2-U4-G2	B2-U4-G2
07	A	Symmetric	P	5530	5970	6220	72	B2-U4-G3	B2-U4-G3	B3-U4-G3
02	B	Asymmetric	P	1930	2090	2170	25	B1-U3-G2	B1-U3-G1	B1-U3-G2
03	B	Asymmetric	P	2280	2460	2560	29	B1-U3-G2	B1-U3-G2	B1-U3-G2
04	B	Asymmetric	P	3140	3390	3530	41	B1-U3-G2	B1-U3-G2	B1-U3-G2
05	B	Asymmetric	P	3830	4130	4300	50	B1-U3-G2	B1-U4-G3	B1-U4-G3
06	B	Asymmetric	P	4240	4580	4770	56	B1-U4-G3	B1-U4-G3	B2-U4-G3
07	B	Asymmetric	P	5170	5580	5810	72	B2-U4-G3	B2-U4-G3	B2-U4-G3
02	A	Symmetric	N	2840	3070	3190	25	B2-U0-G1	B2-U0-G1	B2-U0-G1
03	A	Symmetric	N	3350	3620	3770	29	B2-U0-G1	B2-U0-G1	B2-U0-G1
04	A	Symmetric	N	4620	4980	5190	41	B2-U0-G1	B3-U0-G1	B3-U0-G1
05	A	Symmetric	N	5620	6070	6320	50	B3-U0-G1	B3-U0-G1	B3-U0-G1
06	A	Symmetric	N	6230	6720	7000	56	B3-U0-G1	B3-U0-G1	B3-U0-G1
07	A	Symmetric	N	7590	8190	8530	72	B3-U0-G1	B3-U0-G1	B3-U0-G1
02	B	Asymmetric	N	2660	2870	2980	25	B1-U0-G1	B1-U0-G1	B1-U0-G1
03	B	Asymmetric	N	3130	3380	3520	29	B1-U0-G1	B1-U0-G1	B1-U0-G1
04	B	Asymmetric	N	4320	4660	4850	41	B1-U0-G1	B1-U0-G1	B1-U0-G2
05	B	Asymmetric	N	5250	5670	5900	50	B1-U0-G2	B1-U0-G2	B1-U0-G2
06	B	Asymmetric	N	5820	6280	6540	56	B1-U0-G2	B1-U0-G2	B2-U0-G2
07	B	Asymmetric	N	7090	7650	7970	72	B2-U0-G2	B2-U0-G2	B2-U0-G2

For additional information on EPTT IES files, please click the following link:

[EPTT IES Files](#)

EPTT
Symmetric (Acrylic Refractor)
7,820 Lumens
5,000K
EPTT02_07AA50_-120-277V.IES

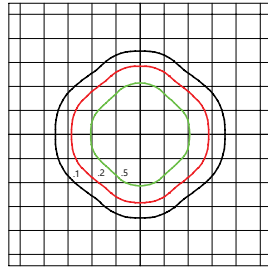

- Grid Distance in Units of Mounting Height at 16'
- Initial Footcandle Values at Grade

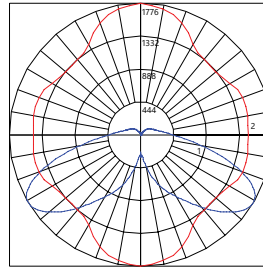

- Vertical plane through horizontal angle of Max. Cd at 90°
- Horizontal cone through vertical angle of Max. Cd at 58°

EPTT
Asymmetric (Acrylic Refractor)
7,300 Lumens
5,000K
EPTT02_07BA50_-120-277V.IES

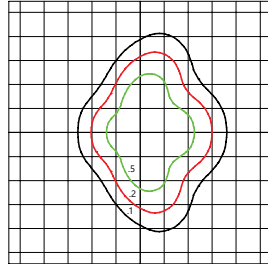

- Grid Distance in Units of Mounting Height at 16'
- Initial Footcandle Values at Grade

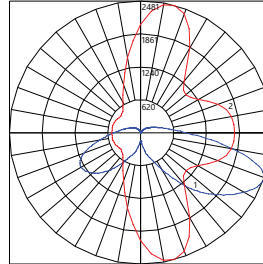

- Vertical plane through horizontal angle of Max. Cd at 75°
- Horizontal cone through vertical angle of Max. Cd at 69°

EPTT
Symmetric (No Refractor)
8,530 Lumens
5,000K
EPTT02_07AN50_-120-277V.IES

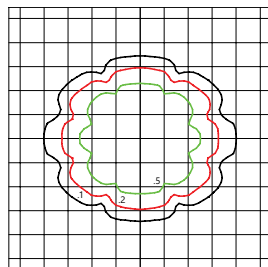

- Grid Distance in Units of Mounting Height at 16'
- Initial Footcandle Values at Grade

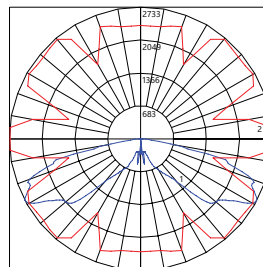

- Vertical plane through horizontal angle of Max. Cd at 5°
- Horizontal cone through vertical angle of Max. Cd at 62°

EPTT
Asymmetric (No Refractor)
7,970 Lumens
5,000K
EPTT02_07BN50_-120-277V.IES

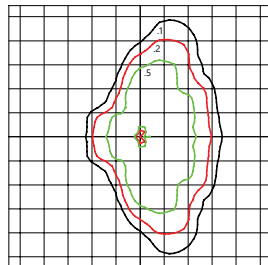

- Grid Distance in Units of Mounting Height at 16'
- Initial Footcandle Values at Grade

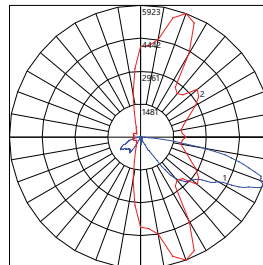

- Vertical plane through horizontal angle of Max. Cd at 70°
- Horizontal cone through vertical angle of Max. Cd at 68°

EPTT
Symmetric (Poly Refractor)
6,220 Lumens
5,000K
EPTT02_07AP50_-120-277V.IES

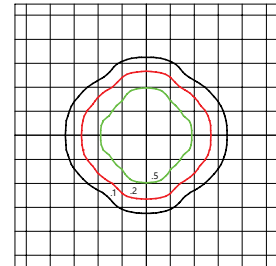

- Grid Distance in Units of Mounting Height at 16'
- Initial Footcandle Values at Grade

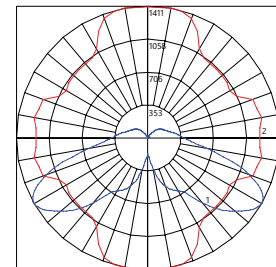

- Vertical plane through horizontal angle of Max. Cd at 80°
- Horizontal cone through vertical angle of Max. Cd at 60°

EPTT
Asymmetric (Poly Refractor)
8,810 Lumens
5,000K
EPTT02_07BP50_-120-277V.IES

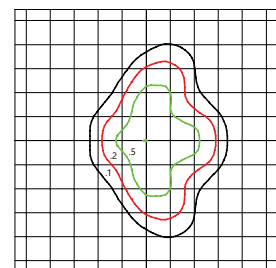

- Grid Distance in Units of Mounting Height at 16'
- Initial Footcandle Values at Grade

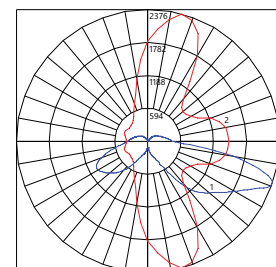

- Vertical plane through horizontal angle of Max. Cd at 75°
- Horizontal cone through vertical angle of Max. Cd at 71°

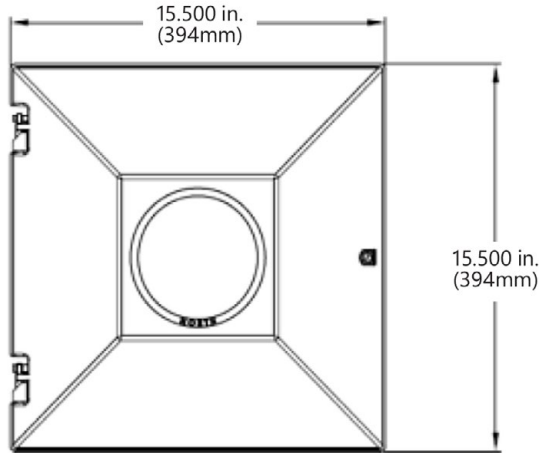

TOP VIEW

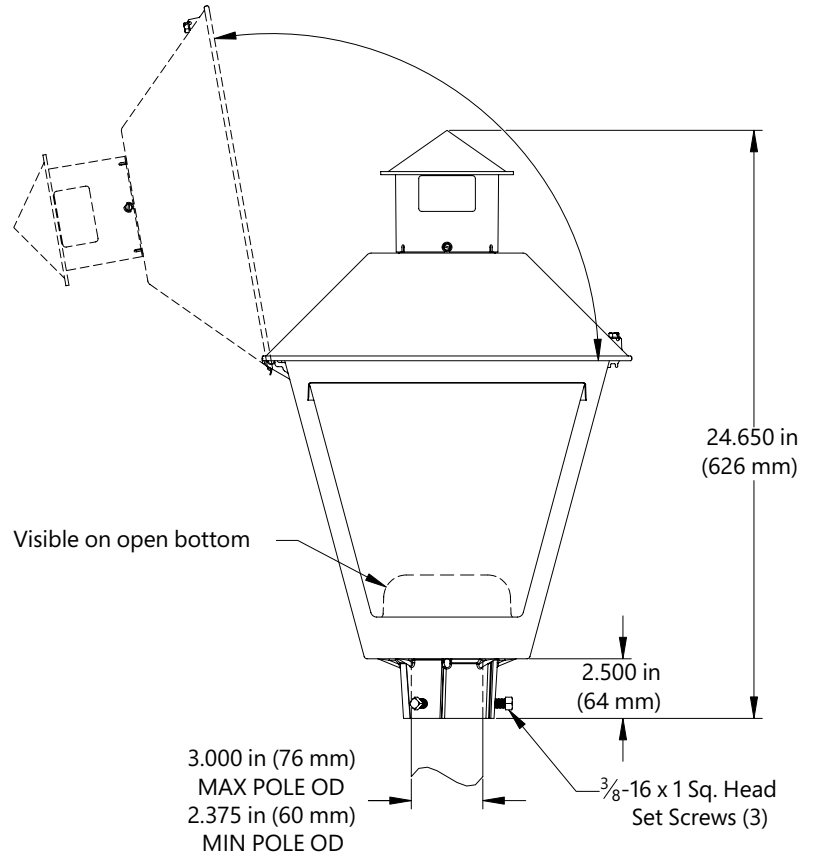

SIDE VIEW

MOUNTING

- Mounts to 2-3/8 to 3-inch (60-76mm) OD vertical tenon
- Suggested Mounting Height = 8-18 ft. (2.5 - 5.5M)

EFFECTIVE PROJECTED AREA

- 1.6 sq. ft. max (0.15 sq M max)

WEIGHT

- 14 lbs (6.2 kgs) - 18 lbs (8 kgs)

EPTT HOUSE SIDE SHIELDS

Part Number	Description
LSPX-TT	Perforated Shield for Open Sided or Refractor Designs
LSSX-TT	Solid "Black" Shield for Open Sided or Refractor Designs
LR-TC	Ladder Rest - Black

NETWORK LIGHTING CONTROLS



Current's **LightGrid™** Outdoor Lighting Control System is designed for Street and Roadway Applications. It enables remote monitoring, control, and asset management of a single fixture or a group of fixtures through a web enabled Central Management System.