



NELLCOTE

STUDIO
www.NellcoteStudio.com











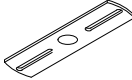

LE MARAIS CHANDELIER

IMPORTANT SAFETY INSTRUCTIONS:

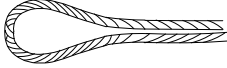
- Consult certified electrician before installation that familiar with commercial type of applications.
- To reduce risk of fire, use 12-watt Compact Fluorescent lamp and do not exceed the recommended wattage.
- The manufacturer and distributor accepts no liability for incorrect installation.
- The ceiling must have at least the capacity of 5 times the weight of the ceiling light. For this light at least a ceiling capacity of 30 kg is required.
- Maximum Supply Current 1 A

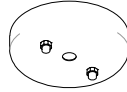
WARNING

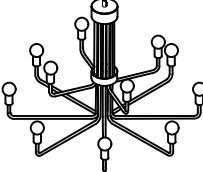
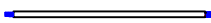
- Turn-off electricity supply at main circuit panel before installing. All wires are connected. Do not remove the ceiling light from its packaging by pulling on the power cord, as a bad connection may result.
- To reduce the risk of fire, electrical shock, or personal injury, always turn off the ceiling light and allow it to cool prior to replacing light bulb. Do not touch bulb when fixture is turned on or look directly at light bulb. Keep flammable materials away from light bulb.
- Deviation from instructions may result in a risk of fire or electric shock.
- Suitable for indoor use only.
- The external flexible cable or cord of this luminaire cannot be replaced; if the cord is damaged, the luminaire shall be destroyed.
- Terminal block not included. Installation may require advice from a qualified person.

A		HANGER BAR (1PC)
B1		LONGER ALL-THREAD (1PC)
B2		ALL-THREAD (1PC)
C		BLACK PLASTIC CORD PROTECTOR (2PCS)
D		NUT (2PCS)
E		WASHER (2PCS)
F		FIXTURE LOOP (2PCS)
G		SUSPENSION WIRE (1PC)
H		WIRE GRIP (2PCS)
I		CANOPY (1PC)
J		SMALL NUT (4PCS)
K		CHANDELIER (1PC)
L		DECORATIVE PIPE WITH THREADED TUBE 12 IN.
M		QUICK LINK (1PC)

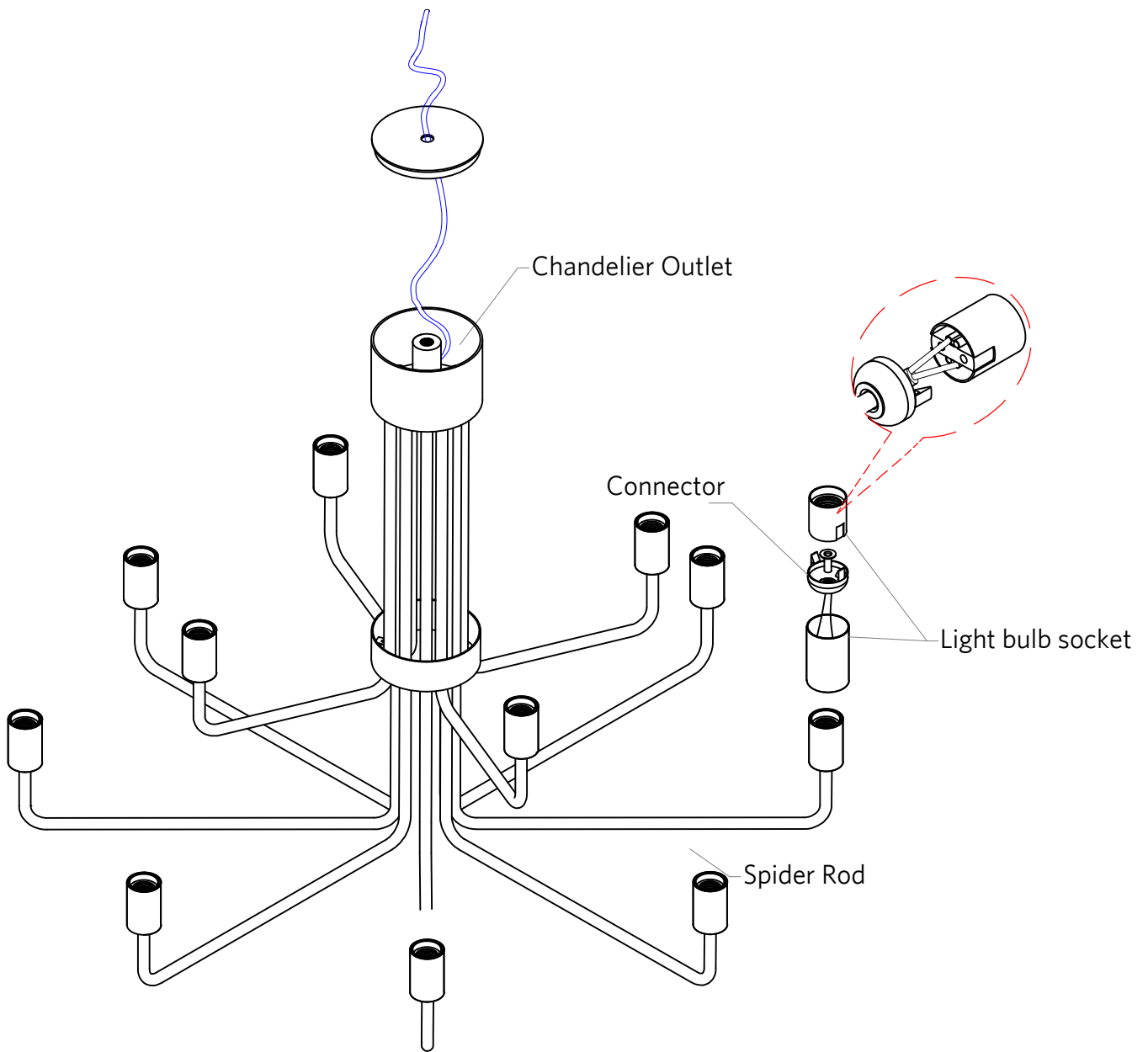

NOTE: in each light bulb socket on the chandelier has the pre-inserted ribbon provided to pull the electric wire from the light bulb socket to the outlet of the chandelier.

1. Connect the electric wire to the connector of the light bulb socket then tie the pre-inserted ribbon to the end of the electric wire.
2. From chandelier outlet side, pull the end of the corresponding pre-inserted ribbon so the electric wire will go through the spider rod to the outlet of the chandelier.

INSTRUCTIONS

1. Open the parts bag and place all on a flat surface.
2. Remove the chandelier body and lay on a flat surface.
3. Screw part the longer all-thread (B1) into the hanger bar (A). (see picture #1).
4. On the "top" of the all thread, above the hanger bar, attach a washer (E), nut (D) and a black plastic cord protector (C). (see pic #2).
5. Bring the lamp base close to your hanging location.
6. Attach Fixture Loop (F) to the smaller piece of all thread- part (B2). Use the set screw to lock. (See picture #3).
7. Thread the electrical cord through the Fixture Loop (F). Attach the all thread (B2) and Fixture Loop (F) to the connector on the lamp body. (see picture #4).
8. Attach one end of the suspension wire (G) to Fixture Loop (F). You will need a pair of pliers to squeeze the wire grips (H). Make sure these are clamped tight around the suspension wire. (see picture #5).
9. Over the end of the electrical you will slide Fixture Loop (F), nickel end cap, the canopy, and then the all thread which is now attached to the hanger bar.
10. Make the electrical connection and cut excess black electrical wire. Leave enough wire for any adjustments you might need to do later.
11. Attach the hanger bar (see picture #6)
12. Push the canopy to the ceiling and tightness flush with the ceiling by spinning onto the all thread, Fixture Loop (F) (see picture #7).
13. Attach the open end of the suspension.

PIC 1

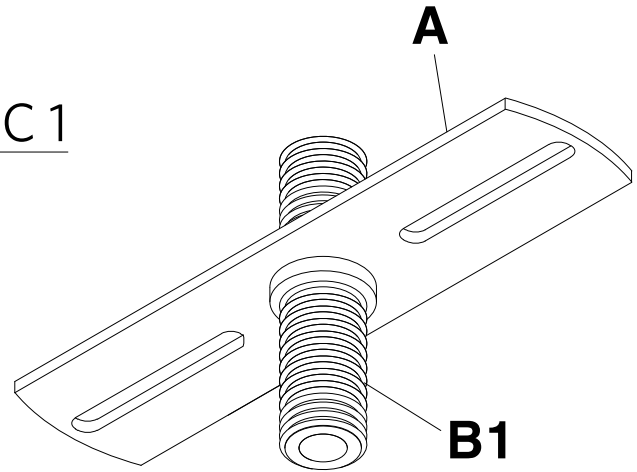

PIC 2

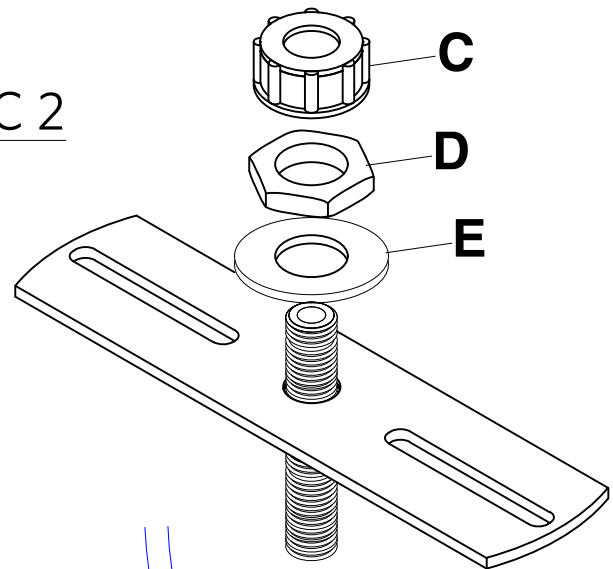

PIC 3

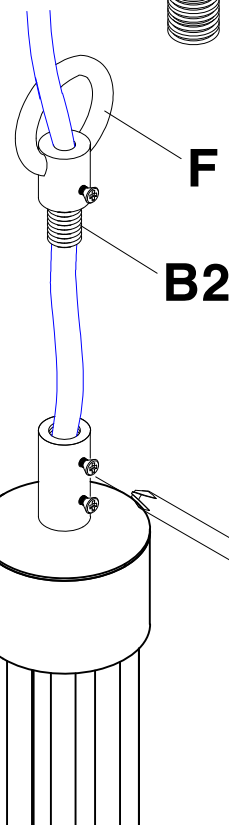

PIC 4

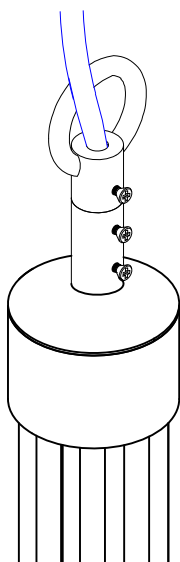

PIC 5

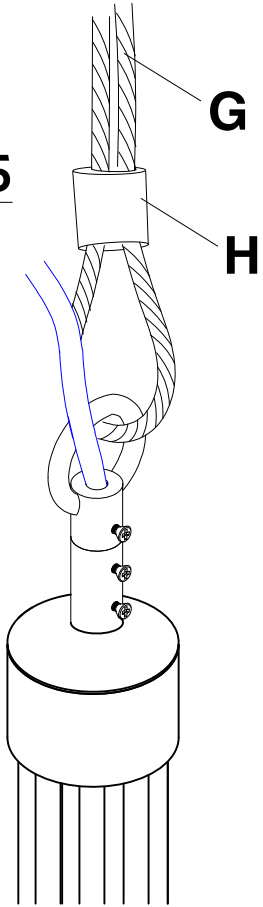

PIC 6

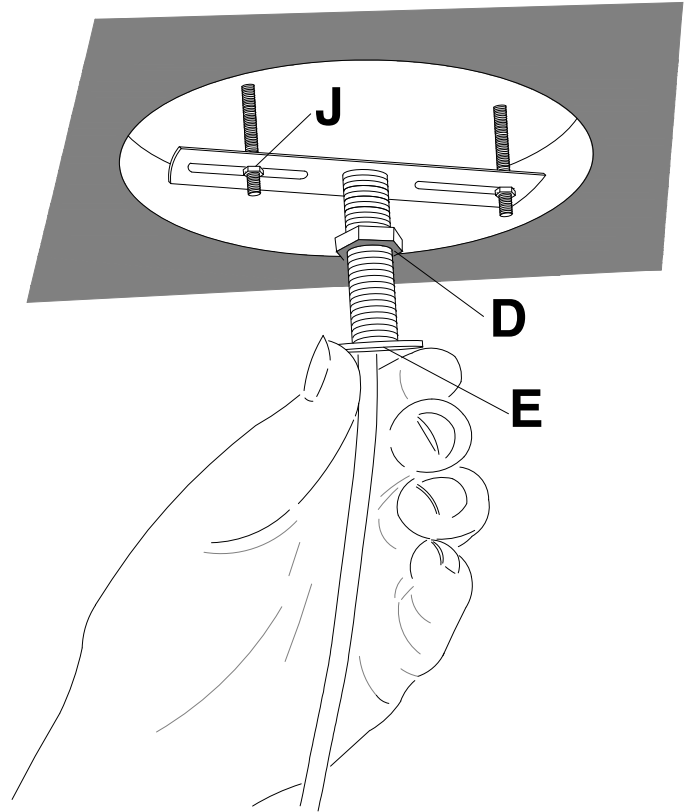

PIC 7

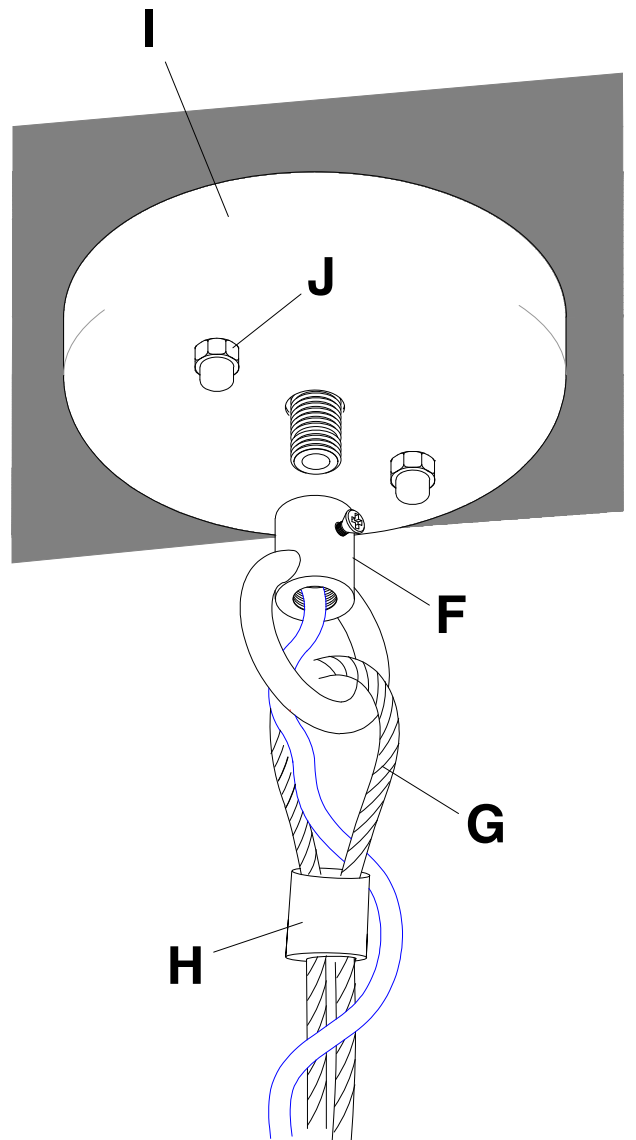
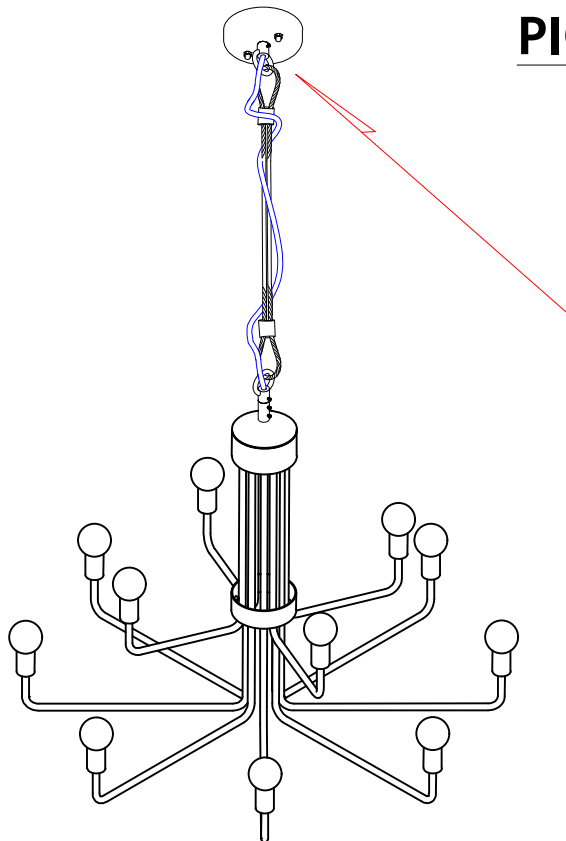

OPTIONAL POLE FOR CHANDELIER

This chandelier can also be hung using a decorative lamp pole. We have provided 3 different sizes, please follow the several steps below depending on your ceiling height.

STEP NO. 1

Thread the electrical cord into the thread tube (L); attach the threaded tube into the connector tube by twisting clockwise and secure this with the set screws.

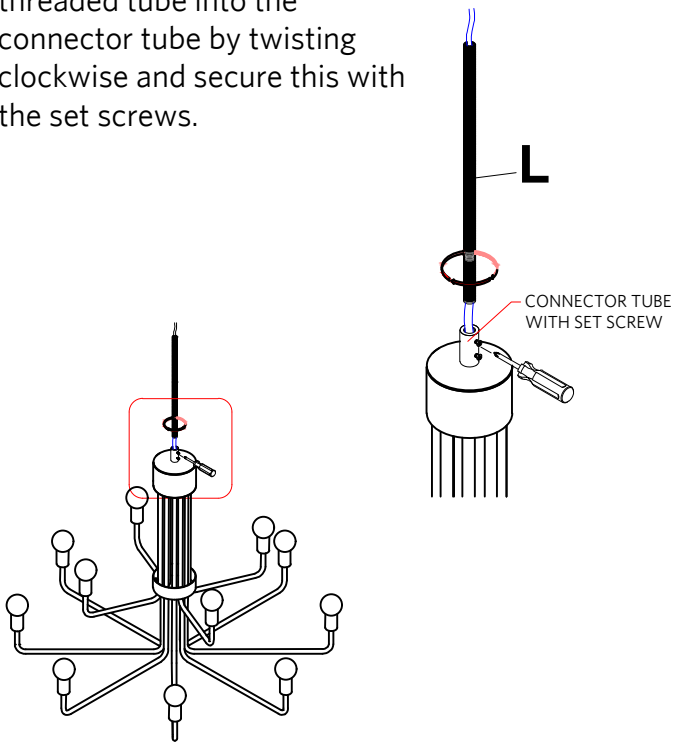

STEP NO. 2

Thread electrical wire through a check ring, your chosen decorative pipe (L), fixture loop (F) and the quick link (M). Slide the check ring and the decorative pipe over the threaded tube and fasten the end with the fixture hook. These will rest atop the connector tube.

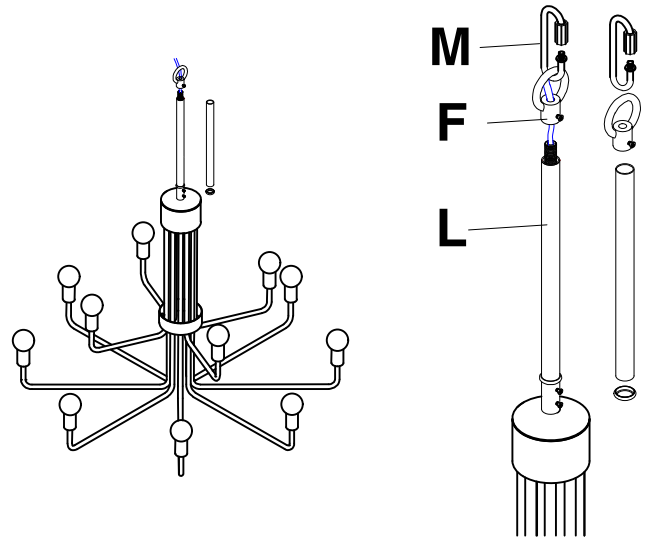

STEP NO. 3

Hook the chandelier into the fixture loop.

