

The logo icon for Tetra, consisting of a stylized white symbol that resembles a circuit board or a network of lines, positioned to the left of the word 'Tetra'.

# Tetra

## Visibly Better

Not all LEDs are created equal. The Tetra® high-efficiency, long-lasting LED signage lighting systems from Current deliver best-in-class performance for channel letter, box sign and border lighting applications. When compared with standard neon or fluorescent lamps, Tetra® LED systems provide significant energy cost reductions, easier job site installation, less frequent maintenance and more consistent brightness and uniformity across your signs.

Current's combination of quality materials, smart design and quality provide you with an easy-to-use and cost-effective option for signage lighting solutions. We are committed to providing the best value for all customers, bringing superior performance and energy efficiency to every business.

We guarantee you'll see the difference in your signage and the bottom line.

## Outshining the Competition

For over 130 years, lighting innovations from GE have changed the way we see and light the world. Today, Current, a Daintree company, is continuing that legacy of innovation, delivering efficient, long-lasting LED lighting solutions that illuminate signs, buildings and cities. Our extensive product portfolio and experienced team are dedicated to promoting your brand visibility and ensuring brilliant operational performance for years to come.

- 130 years of customer satisfaction and industry-leading lighting innovation
- Robust, energy-efficient LED solutions that stand the test of time
- The depth and breadth of GE's lighting portfolio, which has already placed more than 80 million feet of Tetra® LEDs around the globe
- Reliability and performance, backed by the most rigorous in-house testing standards in the industry
- An engineering mindset that uses our people, technology and expertise to solve the industry's most complex problems
- A 50,000-hour rated life – your signs always shine bright
- A 10-year warranty on several products.



# Tetra<sup>®</sup> Atom

CHANNEL LETTER LIGHTING SYSTEMS

Our smallest module ever,  
featuring best-in-class  
loading and groundbreaking  
flexibility

**Tetra<sup>®</sup>Atom** — the unique 24V LED system designed for channel letters as shallow as 1 inch in depth delivers incredibly uniform light, installs easily and operates efficiently. **Tetra<sup>®</sup>Atom** also features constant current technology, for even light across the entire run without the need for center tapping.

## Powerful OptiLens™ X

**Tetra® Atom** features OptiLens™ X, our patented technology that allows for a true 165° x 140° viewing angle. This exclusive technology redirects otherwise wasted light to the sign face, making sure your signs shine.

## Best-in-class loading

Load 327 **Tetra® Atom** modules per 100W power supply, more than **twice as much** as some competitors' solutions. Half the power supplies means half the material and labor costs: only with Tetra®.

## Tetra® for every sign

Designed to meet the evolving needs of sign shops, **Tetra® Atom** delivers bright, uniform light in shallow channel letters, routed acrylic block letters, and halo-lit applications as shallow as 25mm deep.



## Tetra® Atom Features

- Wide 165° x 140° beam angle
- Efficacy: Up to 124 lm/W
- 24 Volt DC, Class 2 (UL), Class III (IEC)
- UL Wet Rated & IP66
- 10-year limited warranty

## Tetra® Atom Spacing

Can Depth	Coverage	Multiple Strings
1" (25mm)	2" (51mm)	1.5" (38mm)*
1.5" (38mm)	4" (102mm)	2.5" (64mm)
2" (51mm)	6" (152mm)	5" (127mm)
3" (76mm)	7" (178mm)	5" (127mm)

\*Face material must be at least 3/16" (5mm) thick

# Total Reliability

To ensure every **Tetra® Atom** installation will operate brilliantly for years, we perform the most extensive, stringent testing in the industry. We test the LED, water and dust ingress protection, sub-system and complete system at our in-house and independent laboratories around the world. Validation of our designs, components, products and processes include high temperature, high humidity and accelerated life testing.



# Mechanical Outline

Dimensions in (inches). Metric equivalent mm

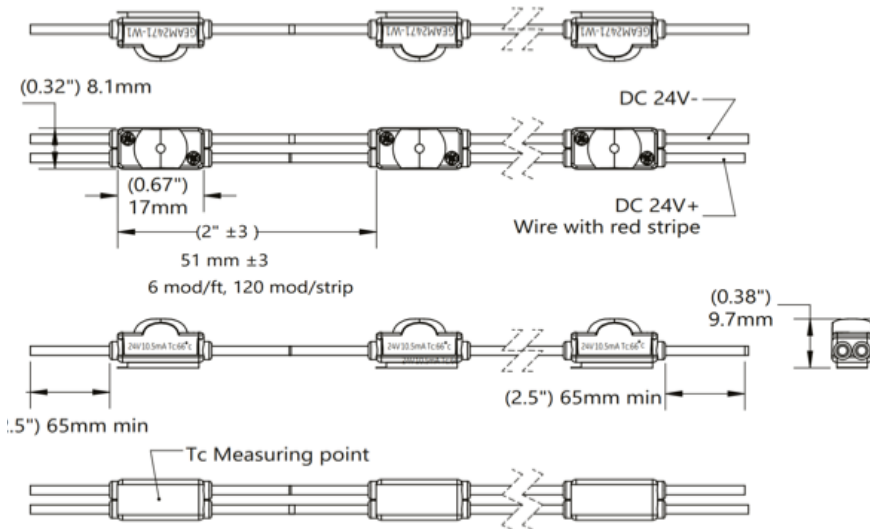

# Accessories

SKU	Description	Package quantity
GETMEC1	18 AWG Wire End Caps (0.82 mm <sup>2</sup> )	100/bag
9409	18 AWG Supply Wire (0.82 mm <sup>2</sup> )	500 ft (152.40m)/spool
191600041	22-14 AWG Twist-on Wire Connector (0.33-2.08 mm <sup>2</sup> )	500/bag
192160004	18-14 AWG In-line Splice Connector (0.82-2.08 mm <sup>2</sup> )	500/bag

# Viewing Angle

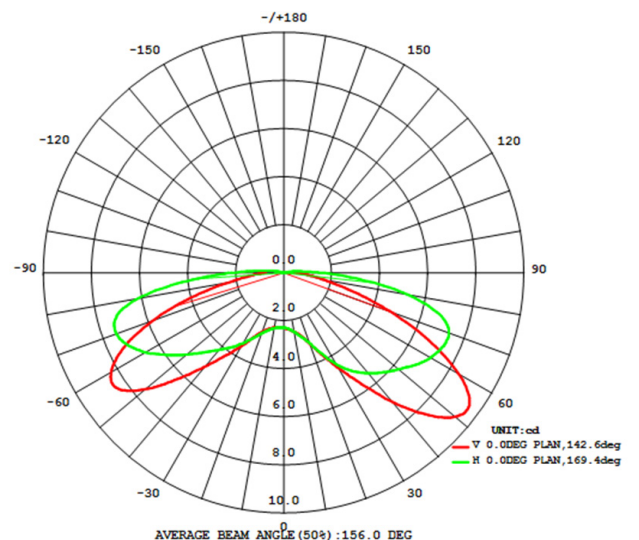

# Components

SKU	Model	Details	Color	Pkg. Quantity	Modules per strip
93119588	GEAM2471-W1	Tetra® Atom 24V 7100K	White	5 Strips/Box	120 modules per strip (6 m/strip)
93119589	GEAM2465-W1	Tetra® Atom 24V 6500K	Warm White	5 Strips/Box	120 modules per strip (6 m/strip)
93119591	GEAM2450-W1	Tetra® Atom 24V 5000K	Warm White	5 Strips/Box	120 modules per strip (6 m/strip)
93119592	GEAM2441-W1	Tetra® Atom 24V 4100K	Warm White	5 Strips/Box	120 modules per strip (6 m/strip)
93119593	GEAM2432-W1	Tetra® Atom 24V 3200K	Warm White	5 Strips/Box	120 modules per strip (6 m/strip)

## Technical Specifications

Model	Wavelength/ CCT	Typical Brightness Lumens/ module	Typical Brightness Lumens/Ft (Lumens/m)	Energy Consumption Module Wattage	Energy Consumption System Wattage	100W GLX Power Supply Loading	100W GLX2/ TT Power Supply Loading	Viewing Angle
GEAM2471-W1	7100K	31	186 (610)	0.25w/module	0.30w/module	50 ft (15.2 m)	50 ft (15.2 m)	165° x 140°
GEAM2465-W1	6500K	31	186 (610)	0.25w/module	0.30w/module	50 ft (15.2 m)	50 ft (15.2 m)	165° x 140°
GEAM2450-W1	5000K	31	186 (610)	0.25w/module	0.30w/module	50 ft (15.2 m)	50 ft (15.2 m)	165° x 140°
GEAM2441-W1	4100K	31	186 (610)	0.25w/module	0.30w/module	50 ft (15.2 m)	50 ft (15.2 m)	165° x 140°
GEAM2432-W1	3200K	28	168 (551)	0.25w/module	0.30w/module	50 ft (15.2 m)	50 ft (15.2 m)	165° x 140°

## Additional Specifications

<b>Dimmable</b>	Yes (with dimmable power supply)				
<b>LEDs/Module</b>	1				
<b>LEDs/ft (LEDs/m)</b>	6 (19.7)				
<b>Modules/ ft. (Modules/m)</b>	6 (19.7)				
<b>Cutting Resolution</b>	Cut on wire between every module				
<b>Power Supply</b>	GEPS24-25-NA Input: 100-305VAC; Output: 24VDC GEPS24D-80U Input: 90-305VAC; Output: 24VDC GEPS24-100U Input: 108-305VAC; Output: 24VDC GEPS24-200U Input: 90-305VAC; Output: 24VDC GEPS24-300U Input: 108-305VAC; Output: 24VDC				
<b>Maximum Supply Wire Limits</b>		<b>18 AWG/0.82 mm<sup>2</sup> Supply Wire</b>	<b>16 AWG/1.31 mm<sup>2</sup> Supply Wire</b>	<b>14 AWG/2.08 mm<sup>2</sup> Supply Wire</b>	<b>12 AWG/3.31 mm<sup>2</sup> Supply Wire</b>
	25W Power Supply	120 ft./36.6 m	/	/	/
	80W Power Supply	20 ft./6.1 m	25 ft./7.6 m	35 ft./10.6 m	40 ft./12.1 m
	100W Power Supply	20 ft./6.1 m	25 ft./7.6 m	35 ft./10.6 m	40 ft./12.1 m
	200W Power Supply	20 ft./6.1 m	25 ft./7.6 m	35 ft./10.6 m	40 ft./12.1 m
300W Power Supply	20 ft./6.1 m	25 ft./7.6 m	35 ft./10.6 m	40 ft./12.1 m	
<b>Operating Environment</b>	-40 °C to +60 °C (-40 °F to +140 °F)				
<b>Module Dimensions (L x W x H)</b>	0.67" x 0.32" x 0.38" (16.9 x 8.1 x 9.7mm)				
<b>Warranty</b>	Limited system warranty of up to ten (10) years				
<b>System Certifications</b>	UL Recognized #E219167, UL Classified #E229508, CE, UKCA, IP66 rated: separate enclosure required, damp location rated				





# Tetra<sup>®</sup> MS

CHANNEL LETTER LIGHTING SYSTEMS

With powerful OptiLens™ X  
and groundbreaking energy  
efficiency

**Tetra<sup>®</sup>MS** — the remarkable 24V LED system designed for small channel letters as shallow as 38mm in depth delivers incredibly uniform light, installs easily and operates efficiently. Tetra<sup>®</sup> MS is IP66 and UL wet rated which makes it more robust and reliable even under wet weather.

## Powerful OptiLens™ X

**Tetra® MS** features OptiLens™ X, our patented technology that allows for a true 165° x 140° viewing angle. This exclusive technology redirects otherwise wasted light to the sign face, making sure your signs shine.

## Class-leading loading

Now load up to 90.5 feet (27.6 m) or 362 modules of 24V **Tetra® MS** per 100W power supply using our new and improved GLX2 power supplies.

## Improved stroke spacing

24V **Tetra® MS** stroke spacing has improved, thanks to the new OptiLens™ X wide beam angle. In addition, its new silicone flow channels have increased bonding strength by 10–20%.



## Tetra®MS Features

- Wide 165° beam angle
- Improved luminous intensity
- Efficacy: Up to 115 lm/W
- 24 Volt DC, Class 2 (UL), Class III (IEC)
- UL Wet Rated & IP66
- 10-year limited warranty

## Tetra®MS Spacing

Can Depth	Coverage	Multiple Strings
1" (25mm)	2" (51mm)	1.5" (38mm)*
1.5" (38mm)	4" (102mm)	2.5" (64mm)
2" (51mm)	6" (152mm)	5" (127mm)
3" (76mm)	7" (178mm)	5" (127mm)

\*Face material must be at least 3/16" (5mm) thick

## Total Reliability

To ensure every **Tetra® MS** installation will operate brilliantly for years, we perform the most extensive, stringent testing in the industry. We test the LED, water and dust ingress protection, sub-system and complete system at our in-house and independent laboratories around the world. Validation of our designs, components, products and processes include high temperature, high humidity and accelerated life testing.



## Mechanical Outline & Viewing Angle

Dimensions in (inches). Metric equivalent mm

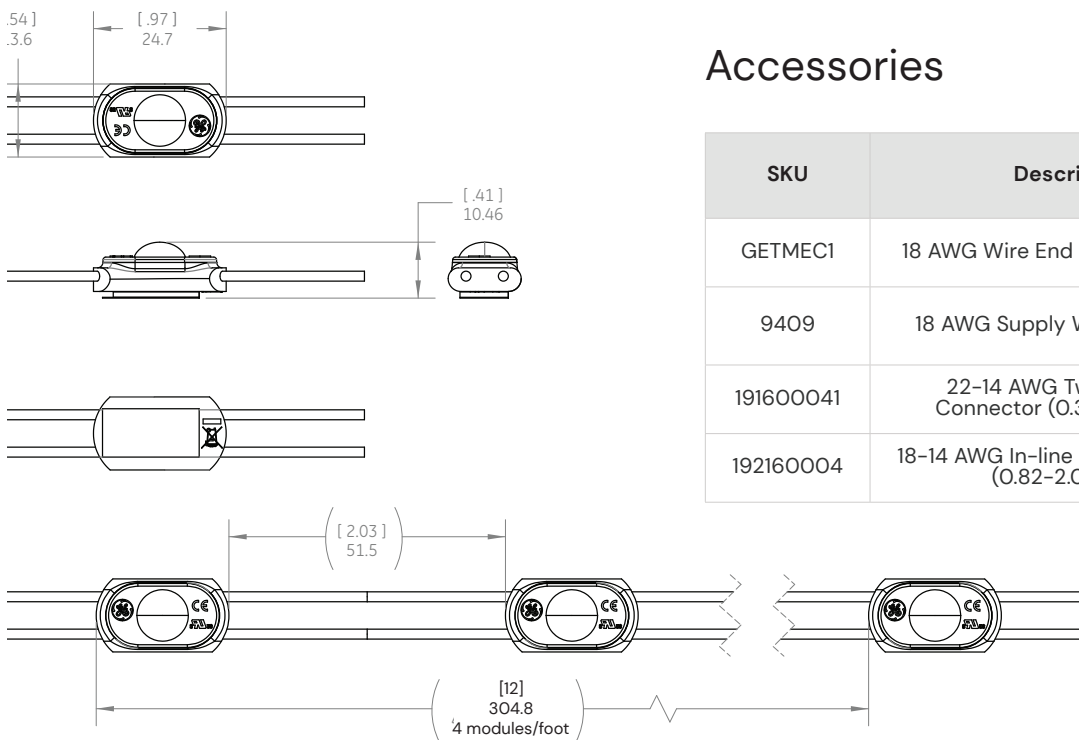

## Accessories

SKU	Description	Package quantity
GETMEC1	18 AWG Wire End Caps (0.82 mm <sup>2</sup> )	100/bag
9409	18 AWG Supply Wire (0.82 mm <sup>2</sup> )	500 ft (152.40m)/spool
191600041	22-14 AWG Twist-on Wire Connector (0.33-2.08 mm <sup>2</sup> )	500/bag
192160004	18-14 AWG In-line Splice Connector (0.82-2.08 mm <sup>2</sup> )	500/bag

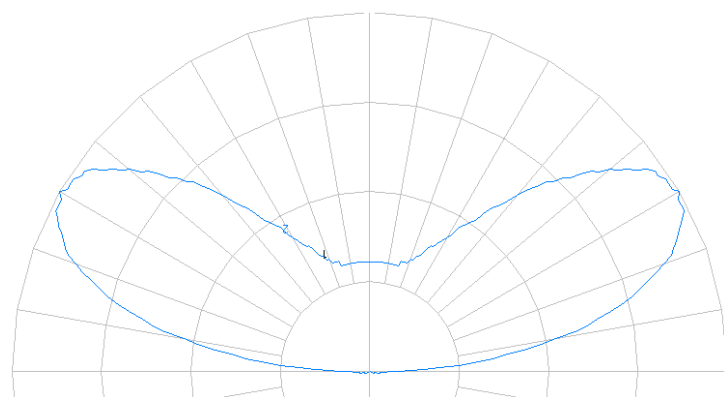

# Components

SKU	Model	Details	Color	Pkg. Quantity	Modules per strip
93053674	GEMS2471-W1	Tetra® Atom 24V 7100K	White	5 Strips/Box	80 modules per strip (6 m/strip)
93118641	GEMS2465-W1	Tetra® Atom 24V 6500K	Warm White	5 Strips/Box	80 modules per strip (6 m/strip)
93053675	GEMS2450-W1	Tetra® Atom 24V 5000K	Warm White	5 Strips/Box	80 modules per strip (6 m/strip)
93053676	GEMS2441-W1	Tetra® Atom 24V 4100K	Warm White	5 Strips/Box	80 modules per strip (6 m/strip)
93053677	GEMS2432-W1	Tetra® Atom 24V 3200K	Warm White	5 Strips/Box	80 modules per strip (6 m/strip)

## Technical Specifications

Model	Wavelength/ CCT	Typical Brightness Lumens/ module	Typical Brightness Lumens/Ft (Lumens/m)	Energy Consumption Module Wattage	Energy Consumption System Wattage	100W GLX Power Supply Loading	100W GLX2/ TT Power Supply Loading	Viewing Angle
GEAM2471-W1	7100K	27.5	110 (361)	0.24w/module	0.27w/module	85 ft (25.9 m)	90.5 ft (27.6 m)	165°
GEAM2465-W1	6500K	27.5	110 (361)	0.24w/module	0.27w/module	85 ft (25.9 m)	90.5 ft (27.6 m)	165°
GEAM2450-W1	5000K	27.5	110 (361)	0.24w/module	0.27w/module	85 ft (25.9 m)	90.5 ft (27.6 m)	165°
GEAM2441-W1	4100K	27.5	110 (361)	0.24w/module	0.27w/module	85 ft (25.9 m)	90.5 ft (27.6 m)	165°
GEAM2432-W1	3200K	25	100 (328)	0.24w/module	0.27w/module	85 ft (25.9 m)	90.5 ft (27.6 m)	165°

## Additional Specifications

<b>Dimmable</b>	Yes (with dimmable power supply)				
<b>LEDs/Module</b>	1				
<b>LEDs/ft (LEDs/m)</b>	4 (13)				
<b>Modules/ ft. (Modules/m)</b>	4 (13)				
<b>Cutting Resolution</b>	Cut on wire between every module				
<b>Power Supply</b>	GEPS24-25-NA Input: 100-305VAC; Output: 24VDC GEPS24D-80U Input: 90-305VAC; Output: 24VDC GEPS24-100U Input: 108-305VAC; Output: 24VDC GEPS24-200U Input: 90-305VAC; Output: 24VDC GEPS24-300U Input: 108-305VAC; Output: 24VDC				
<b>Maximum Supply Wire Limits</b>		<b>18 AWG/0.82 mm<sup>2</sup> Supply Wire</b>	<b>16 AWG/1.31 mm<sup>2</sup> Supply Wire</b>	<b>14 AWG/2.08 mm<sup>2</sup> Supply Wire</b>	<b>12 AWG/3.31 mm<sup>2</sup> Supply Wire</b>
	25W Power Supply	120 ft./36.6 m	/	/	/
	80W Power Supply	20 ft./6.1 m	25 ft./7.6 m	35 ft./10.6 m	40 ft./12.1 m
	100W Power Supply	20 ft./6.1 m	25 ft./7.6 m	35 ft./10.6 m	40 ft./12.1 m
	200W Power Supply	20 ft./6.1 m	25 ft./7.6 m	35 ft./10.6 m	40 ft./12.1 m
300W Power Supply	20 ft./6.1 m	25 ft./7.6 m	35 ft./10.6 m	40 ft./12.1 m	
<b>Operating Environment</b>	-40 °C to +60 °C (-40 °F to +140 °F)				
<b>Module Dimensions (h x l x w)</b>	0.41" x 0.97" x 0.54" (10.46 mm x 24.7 mm x 13.6 mm)				
<b>Warranty</b>	Limited system warranty of up to ten (10) years				
<b>System Certifications</b>	UL Recognized #E219167, UL Classified #E229508, CE, UKCA, IP66 rated: separate enclosure required, damp location rated				





# Tetra<sup>®</sup> miniMAX

CHANNEL LETTER LIGHTING SYSTEMS

With powerful OptiLens<sup>™</sup> X  
and groundbreaking energy  
efficiency

**Tetra<sup>®</sup>miniMAX** white — the 24V remarkable LED system designed for small & medium channel letters as shallow as 38mm in depth delivers incredibly uniform light, installs easily and operates efficiently. **Tetra<sup>®</sup>miniMAX** is IP66 and UL wet rated which makes it more robust and reliable than ever, even under wet weather.

## Powerful OptiLens™ X

**Tetra® miniMAX** features OptiLens™ X, our patented technology that allows for an incredible 175° viewing angle. This exclusive technology redirects otherwise wasted light to the sign face, making sure your signs shine.

## Best-in-Class Loading

Now load up to 118.5 feet (36.1 m) or 237 modules of 24V **Tetra® miniMAX** per 100W power supply using our new and improved GLX2 power supplies

## Tetra® miniMAX Features

- Wide 175° beam angle
- Efficacy: Up to 157 lm/W for the whites
- 24 Volt DC, UL Wet Rated & IP66
- 10-year limited warranty



## Accessories

SKU	Description	Package quantity
GETMEC1	18 AWG Wire End Caps (0.82 mm <sup>2</sup> )	100/bag
9409	18 AWG Supply Wire (0.82 mm <sup>2</sup> )	500 ft (152.40m)/spool
191600041	22-14 AWG Twist-on Wire Connector (0.33-2.08 mm <sup>2</sup> )	500/bag
192160004	18-14 AWG In-line Splice Connector (0.82-2.08 mm <sup>2</sup> )	500/bag

## Tetra® miniMAX Spacing

	Can Depth	Coverage
<b>Medium</b>	1.5-3" (38-76mm)	3-6.5" (76-165mm)
	3-4" (76-102mm)	5-8" (127-203mm)
<b>Large</b>	4-5" (102-127mm)	8-11" (203-279mm)
	5-6" (127-152mm)	13-15" (330-381mm)

# Total Reliability

To ensure every **Tetra® miniMAX** installation will operate brilliantly for years, we perform the most extensive, stringent testing in the industry. We test the LED, water and dust ingress protection, sub-system and complete system at our in-house and independent laboratories around the world. Validation of our designs, components, products and processes include high temperature, high humidity and accelerated life testing.



# Mechanical Outline & Viewing Angle

Dimensions in (inches). Metric equivalent mm

## Tetra miniMAX 24V whites

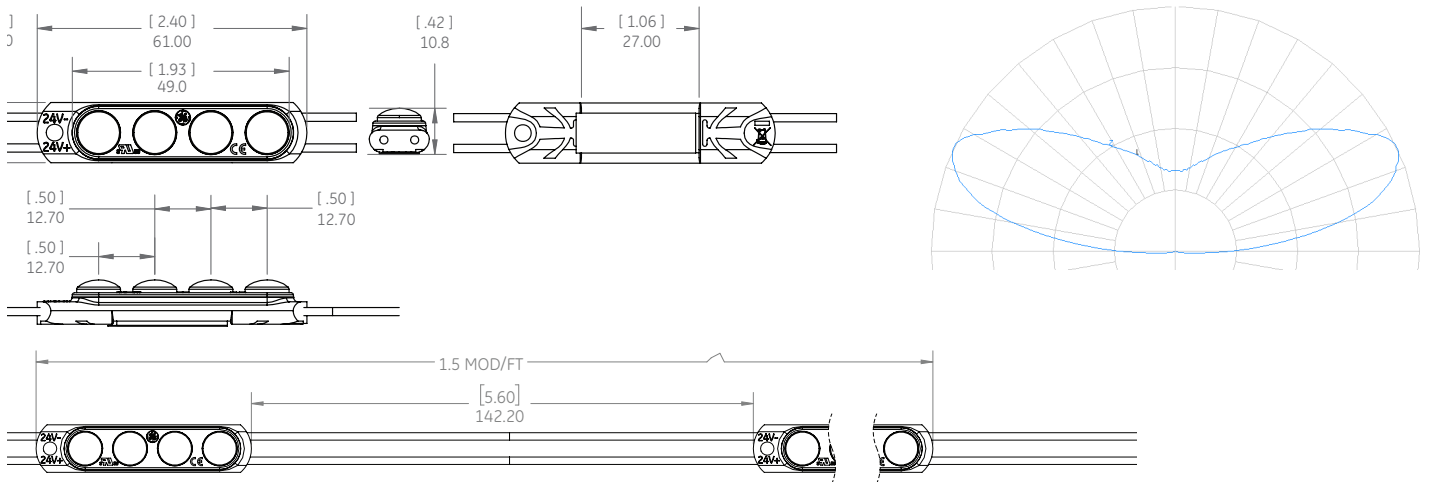

## Tetra miniMAX 24V colors

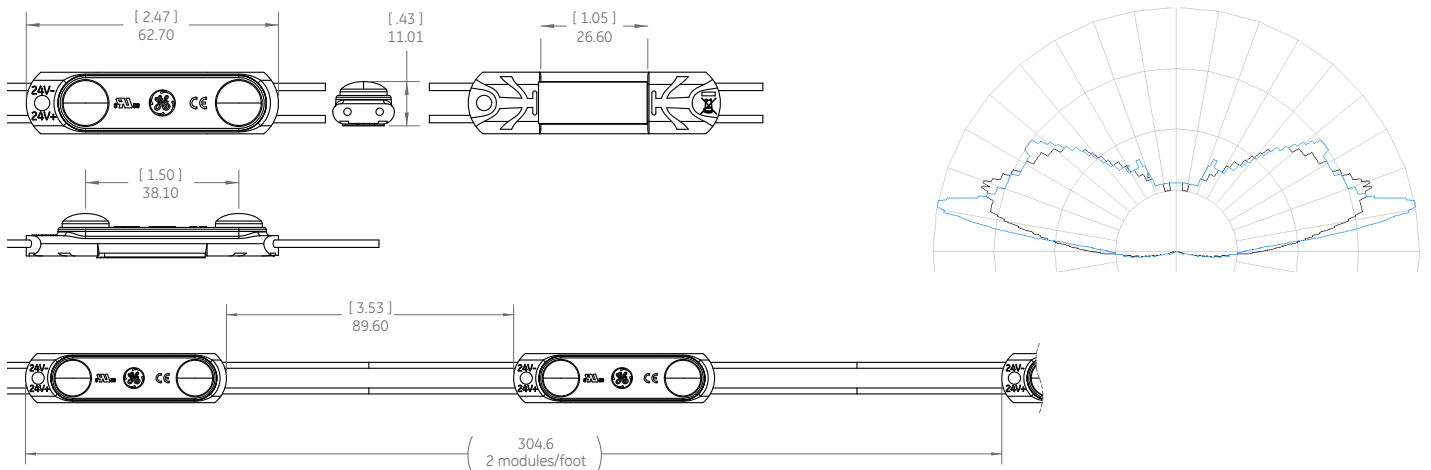

# Components

SKU	Model	Details	Color	Order unit	Pkg. Quantity	Modules per strip
93053666	GEmm <sup>2</sup> 471-W1	Tetra® miniMAX 24V 7100K	White	Box	5 Strips/Box	80 modules per strip (6 m/strip)
93118643	GEmm <sup>2</sup> 465-W1	Tetra® miniMAX 24V 6500K	Warm White	Box	5 Strips/Box	80 modules per strip (6 m/strip)
93118644	GEmm <sup>2</sup> 457-W1	Tetra® miniMAX 24V 5700K	Warm White	Box	5 Strips/Box	80 modules per strip (6 m/strip)
93053667	GEmm <sup>2</sup> 450-W1	Tetra® miniMAX 24V 5000K	Warm White	Box	5 Strips/Box	80 modules per strip (6 m/strip)
93053668	GEmm <sup>2</sup> 441-W1	Tetra® miniMAX 24V 4100K	Warm White	Box	5 Strips/Box	80 modules per strip (6 m/strip)
93053669	GEmm <sup>2</sup> 432-W1	Tetra® miniMAX 24V 3200K	Warm White	Box	5 Strips/Box	80 modules per strip (6 m/strip)
93069932	GEmm <sup>2</sup> 4RD-W1	Tetra® miniMAX colors 24V - 625nm	Red	Box	5 Strips/Box	80 modules per strip (6 m/strip)
93069933	GEmm <sup>2</sup> 4GL-W1	Tetra® miniMAX colors 24V - 530nm	Green	Box	5 Strips/Box	80 modules per strip (6 m/strip)
93069934	GEmm <sup>2</sup> 4BL-W1	Tetra® miniMAX colors 24V - 470nm	Blue	Box	5 Strips/Box	80 modules per strip (6 m/strip)

## Technical Specifications

Model	Wavelength/ CCT	Typical Brightness Lumens/ module	Typical Brightness Lumens/Ft (Lumens/m)	Energy Consumption Module Wattage	Energy Consumption System Wattage	100W GLX Power Supply Loading	100W GLX2/ TT Power Supply Loading	Viewing Angle
GEmm <sup>2</sup> 471-W1	7100K	55	110 (361)	0.35w/module	0.41w/module	110 ft (33.5 m)	118.5 ft (36.1 m)	175°
GEmm <sup>2</sup> 465-W1	6500K	55	110 (361)	0.35w/module	0.41w/module	110 ft (33.5 m)	118.5 ft (36.1 m)	175°
GEmm <sup>2</sup> 457-W1	5700K	55	110 (361)	0.35w/module	0.41w/module	110 ft (33.5 m)	118.5 ft (36.1 m)	175°
GEmm <sup>2</sup> 450-W1	5000K	55	110 (361)	0.35w/module	0.41w/module	110 ft (33.5 m)	118.5 ft (36.1 m)	175°
GEmm <sup>2</sup> 441-W1	4100K	55	110 (361)	0.35w/module	0.41w/module	110 ft (33.5 m)	118.5 ft (36.1 m)	175°
GEmm <sup>2</sup> 432-W1	3200K	50	100 (328)	0.35w/module	0.41w/module	110 ft (33.5 m)	118.5 ft (36.1 m)	175°
GEmm <sup>2</sup> 4RD-W1	625nm	15	30 (98.4)	0.34w/module	0.40w/module	120 ft (36.5 m)	129 ft (39.3 m)	175°
GEmm <sup>2</sup> 4GL-W1	530nm	33	66 (216.5)	0.58w/module	0.68w/module	71 ft (21.7 m)	75 ft (22.8 m)	175°
GEmm <sup>2</sup> 4BL-W1	470nm	11	22 (72.2)	0.53w/module	0.62w/module	77.5 ft (23.6 m)	82 ft (25 m)	175°

## Additional Specifications

	Whites	Colors			
<b>Dimmable</b>	Yes (with dimmable power supply)	Yes (with dimmable power supply)			
<b>LEDs/Module</b>	4	2			
<b>LEDs/ft (LEDs/m)</b>	8 (26)	4 (13)			
<b>Modules/ ft. (Modules/m)</b>	4 (13)				
<b>Module Dimensions (h x l x w)</b>	0.41 in x 2.4 in x 0.54 in (10.46 mm x 61 mm x 13.6 mm)	0.43 in x 2.47 in x 0.6 in (11.01 mm x 62.7 mm x 15.3 mm)			
<b>Cutting Resolution</b>	Cut on wire between every module				
<b>Power Supply</b>	GEPS24-25-NA Input: 100-305VAC; Output: 24VDC GEPS24D-80U Input: 90-305VAC; Output: 24VDC GEPS24-100U Input: 108-305VAC; Output: 24VDC		GEPS24-200U Input: 90-305VAC; Output: 24VDC GEPS24-300U Input: 108-305VAC; Output: 24VDC		
<b>Maximum Supply Wire Limits</b>		<b>18 AWG/0.82 mm<sup>2</sup> Supply Wire</b>	<b>16 AWG/1.31 mm<sup>2</sup> Supply Wire</b>	<b>14 AWG/2.08 mm<sup>2</sup> Supply Wire</b>	<b>12 AWG/3.31 mm<sup>2</sup> Supply Wire</b>
	25W Power Supply	120 ft./36.6 m	/	/	/
	80W Power Supply	20 ft./6.1 m	25 ft./7.6 m	35 ft./10.6 m	40 ft./12.1 m
	100W Power Supply	20 ft./6.1 m	25 ft./7.6 m	35 ft./10.6 m	40 ft./12.1 m
	200W Power Supply	20 ft./6.1 m	25 ft./7.6 m	35 ft./10.6 m	40 ft./12.1 m
300W Power Supply	20 ft./6.1 m	25 ft./7.6 m	35 ft./10.6 m	40 ft./12.1 m	
<b>Operating Environment</b>	-40 °C to +60 °C (-40 °F to +140 °F)				
<b>Warranty</b>	Limited system warranty of up to ten (10) years				
<b>System Certifications</b>	UL Recognized (C-US) #E219167, UL Classified (C-US) #E229508, CE, ROHS • IP66 rated: for dry, damp or wet location.				





# Tetra<sup>®</sup> MAX

CHANNEL LETTER LIGHTING SYSTEMS

---

Good things come in  
small packages

Our revolutionary **Tetra<sup>®</sup>MAX** LED signage modules have an all-new look. We've reduced the white module size by 25%, which brings our industry-leading 161 lm/W to a wider range of applications. And thanks to OptiLens™ X, **Tetra<sup>®</sup>MAX** has an improved viewing angle of 175°, ensuring perfectly uniform sign face illumination. Get more light for less with **Tetra<sup>®</sup>MAX**.

## Powerful OptiLens™ X

**Tetra® MAX** features **OptiLens™ X**, our patented technology that allows for an incredible 175° viewing angle. This exclusive technology redirects otherwise wasted light to the sign face, making sure your signs shine.

## Power Supply Loading

Now load up to 92.6 feet (28.2 m) or 139 modules of 24V **Tetra® MAX** per 100W power supply using our new and improved GLX2 power supplies.

## Improved stroke spacing

The new 24V Tetra® MAX stroke spacing has improved on average by 37%, thanks to the new OptiLens™ X wide beam angle.



## Tetra®MAX Features

- Wide 175° beam angle
- Efficacy: Up to 161 lm/W for the whites
- 24 Volt DC, UL Wet Rated & IP66
- 10-year limited warranty

## Accessories

SKU	Description	Package quantity
GETMEC1	18 AWG Wire End Caps (0.82 mm <sup>2</sup> )	100/bag
9409	18 AWG Supply Wire (0.82 mm <sup>2</sup> )	500 ft (152.40m)/spool
191600041	22-14 AWG Twist-on Wire Connector (0.33-2.08 mm <sup>2</sup> )	500/bag
192160004	18-14 AWG In-line Splice Connector (0.82-2.08 mm <sup>2</sup> )	500/bag

## Tetra® MAX Spacing

	Can Depth	Coverage
<b>Medium</b>	4-5" (102-127mm)	11-14" (279-356mm)
	5-6" (127-152mm)	14-17" (356-431mm)
<b>Large</b>	≥ 6" (152mm)	17-20" (431-508mm)

# Total Reliability

To ensure every **Tetra® MAX** installation will operate brilliantly for years, we perform the most extensive, stringent testing in the industry. We test the LED, water and dust ingress protection, sub-system and complete system at our in-house and independent laboratories around the world. Validation of our designs, components, products and processes include high temperature, high humidity and accelerated life testing.



# Mechanical Outline & Viewing Angle

Dimensions in (inches). Metric equivalent mm

## Tetra® MAX 24V whites

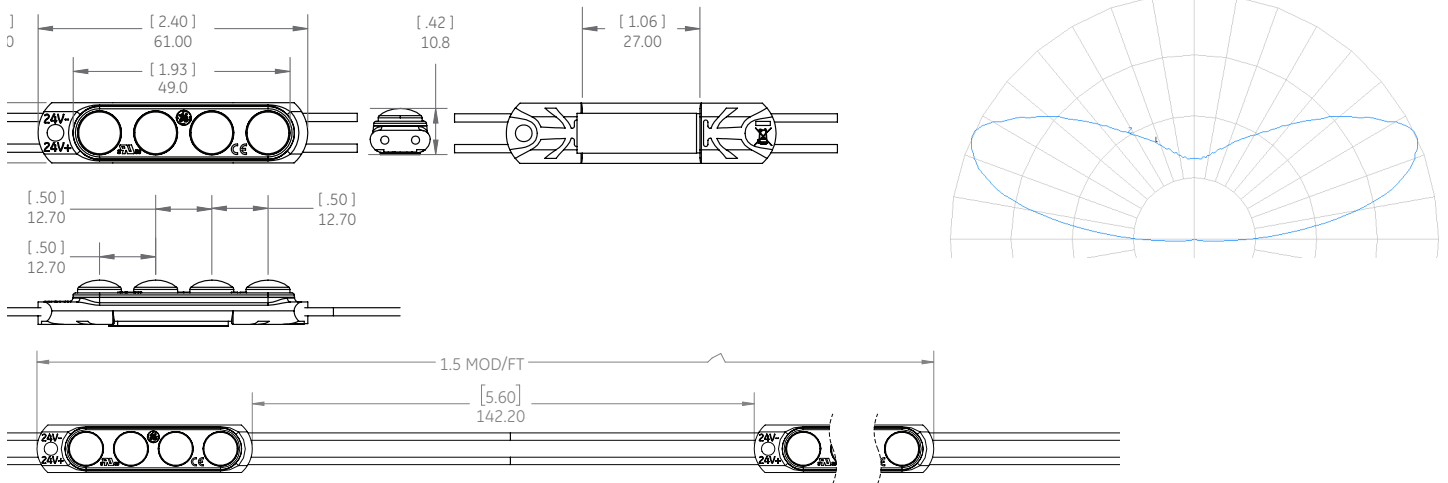

## Tetra® MAX 24V colors

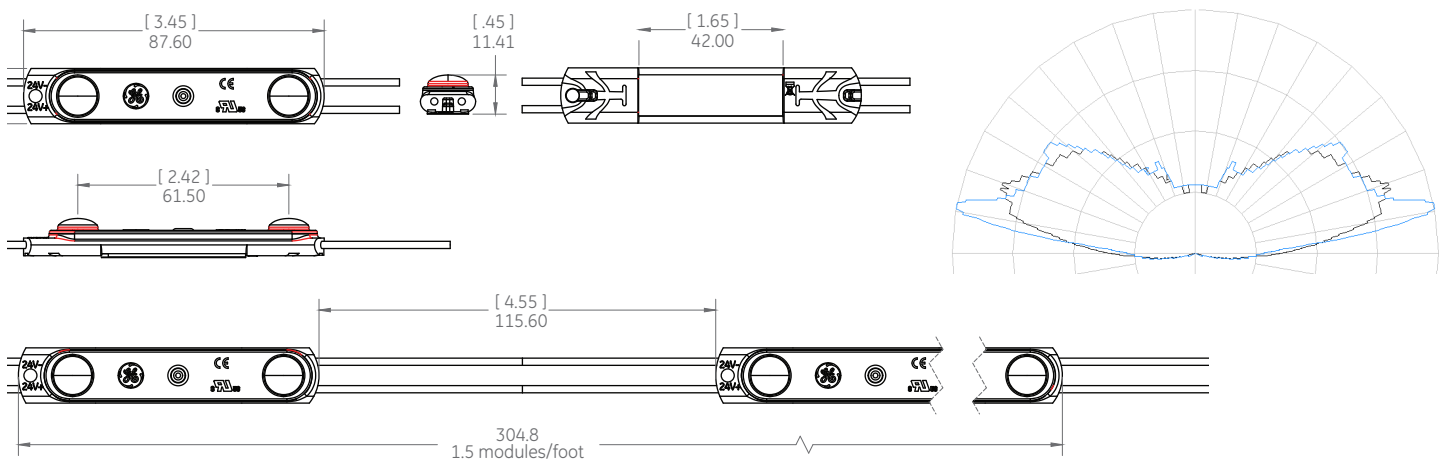

# Components

SKU	Model	Details	Color	Order unit	Pkg. Quantity	Modules per strip
93098199	GEMX2471-WIS	Tetra® MAX 24V 7100K	White	Box	5 Strips/Box	30 modules/strip (6 m/strip)
93118645	GEMX2465-WIS	Tetra® MAX 24V 6500K	Warm White	Box	5 Strips/Box	30 modules/strip (6 m/strip)
93118726	GEMX2457-WIS	Tetra® MAX 24V 5700K	Warm White	Box	5 Strips/Box	30 modules/strip (6 m/strip)
93098200	GEMX2450-WIS	Tetra® MAX 24V 5000K	Warm White	Box	5 Strips/Box	30 modules/strip (6 m/strip)
93098201	GEMX2441-WIS	Tetra® MAX 24V 4100K	Warm White	Box	5 Strips/Box	30 modules/strip (6 m/strip)
93098202	GEMX2432-WIS	Tetra® MAX 24V 3200K	Warm White	Box	5 Strips/Box	30 modules/strip (6 m/strip)
93069935	GEMX24RD-W1	Tetra® MAX colors 24V – 625 nm	Red	Box	5 Strips/Box	30 modules/strip (6 m/strip)
93070026	GEMXH24RD-W1	Tetra® MAX colors 24V HO – 625 nm	Red	Box	5 Strips/Box	30 modules/strip (6 m/strip)
93070027	GEMX24GL-W1	Tetra® MAX colors 24V – 530 nm	Green	Box	5 Strips/Box	30 modules/strip (6 m/strip)
93070028	GEMX24BL-W1	Tetra® MAX colors 24V – 470 nm	Blue	Box	5 Strips/Box	30 modules/strip (6 m/strip)
93070029	GEMX24YG-W1	Tetra® MAX colors 24V – 589 nm	Amber	Box	5 Strips/Box	30 modules/strip (6 m/strip)

## Technical Specifications

Model	Wavelength/ CCT	Typical Brightness Lumens/ module	Typical Brightness Lumens/Ft (Lumens/m)	Energy Consumption Module Wattage	Energy Consumption System Wattage	100W GLX Power Supply Loading	100W GLX2/ TT Power Supply Loading	Viewing Angle
GEMX2471-WIS	7100K	100	150 (492)	0.62 W/module	0.73 W/module	87 ft (26.5 m)	92.6 ft (28.2 m)	175°
GEMX2465-WIS	6500K	100	150 (492)	0.62 W/module	0.73 W/module	87 ft (26.5 m)	92.6 ft (28.2 m)	175°
GEMX2457-WIS	5700K	100	150 (492)	0.62 W/module	0.73 W/module	87 ft (26.5 m)	92.6 ft (28.2 m)	175°
GEMX2450-WIS	5000K	100	150 (492)	0.62 W/module	0.73 W/module	87 ft (26.5 m)	92.6 ft (28.2 m)	175°
GEMX2441-WIS	4100K	100	150 (492)	0.62 W/module	0.73 W/module	87 ft (26.5 m)	92.6 ft (28.2 m)	175°
GEMX2432-WIS	3200K	90	135 (443)	0.62 W/module	0.73 W/module	87 ft (26.5 m)	92.6 ft (28.2 m)	175°
GEMX24RD-W1	625nm	20	30 (98)	0.46 W/module	0.54 W/module	120 ft (36.5 m)	126.6 ft (38.5 m)	175°
GEMXH24RD-W1	625nm	32	48 (158)	0.74 W/module	0.87 W/module	73 ft (22.3 m)	77.3 ft (23.5 m)	175°
GEMX24GL-W1	530nm	44	66 (217)	0.77 W/module	0.91 W/module	71 ft (21.7 m)	75.3 ft (22.9 m)	175°
GEMX24BL-W1	470nm	15	23 (74)	0.70 W/module	0.82 W/module	79 ft (23.9 m)	82.6 (25.1 m)	175°
GEMX24YG-W1	589nm	14	23 (74)	0.38 W/module	0.45 W/module	140 ft (42.6 m)	150.6 ft (45.9 m)	175°

## Additional Specifications

	Whites	Colors			
<b>Dimmable</b>	Yes (with dimmable power supply)	Yes (with dimmable power supply)			
<b>LEDs/Module</b>	4	2			
<b>LEDs/ft (LEDs/m)</b>	6 (19.7)	3 (9.8)			
<b>Modules/ ft. (Modules/m)</b>	1.5 (4.9)	1.5 (4.9)			
<b>Module Dimensions (h x l x w)</b>	0.41 in x 2.4 in x 0.54 in (10.46 mm x 61 mm x 13.6 mm)	0.45 in x 3.45 in x 0.63 in (11.41 mm x 87.6 mm x 16.1 mm)			
<b>Cutting Resolution</b>	Cut on wire between every module				
<b>Power Supply</b>	GEPS24-25-NA Input: 100-305VAC; Output: 24VDC GEPS24D-80U Input: 90-305VAC; Output: 24VDC GEPS24-100U Input: 108-305VAC; Output: 24VDC	GEPS24-200U Input: 90-305VAC; Output: 24VDC GEPS24-300U Input: 108-305VAC; Output: 24VDC			
<b>Maximum Supply Wire Limits</b>	<b>18 AWG/0.82 mm<sup>2</sup> Supply Wire</b>	<b>16 AWG/1.31 mm<sup>2</sup> Supply Wire</b>	<b>14 AWG/2.08 mm<sup>2</sup> Supply Wire</b>	<b>12 AWG/3.31 mm<sup>2</sup> Supply Wire</b>	
	25W Power Supply	120 ft./36.6 m	/	/	
	80W Power Supply	20 ft./6.1 m	25 ft./7.6 m	35 ft./10.6 m	40 ft./12.1 m
	100W Power Supply	20 ft./6.1 m	25 ft./7.6 m	35 ft./10.6 m	40 ft./12.1 m
	200W Power Supply	20 ft./6.1 m	25 ft./7.6 m	35 ft./10.6 m	40 ft./12.1 m
300W Power Supply	20 ft./6.1 m	25 ft./7.6 m	35 ft./10.6 m	40 ft./12.1 m	
<b>Operating Environment</b>	-40 °C to +60 °C (-40 °F to +140 °F)				
<b>Warranty</b>	Limited system warranty of up to ten (10) years				
<b>System Certifications</b>	UL Recognized (C-US) #E219167, UL Classified (C-US) #E229508, CE, ROHS • IP66 rated: for dry, damp or wet location.				





# Tetra<sup>®</sup> PowerMAX

CHANNEL LETTER LIGHTING SYSTEMS

With powerful OptiLens™ X  
and groundbreaking energy  
efficiency

**Tetra<sup>®</sup>PowerMAX** — the 24V remarkable LED system designed for channel letters as shallow as 102mm in depth, as well as cabinet signs, delivers incredibly uniform light, installs easily and operates efficiently. **Tetra<sup>®</sup>PowerMAX** is now IP66 and UL wet rated which makes it more robust and reliable than ever, even under wet weather.

## Powerful OptiLens™ X

**Tetra® PowerMAX** features OptiLens™ X, our patented technology that allows for an incredible 170° viewing angle. This exclusive technology redirects otherwise wasted light to the sign face, making sure your signs shine.

## Power Supply Loading

Now load up to 68.6 feet (20.9 m) or 103 modules of 24V **Tetra® PowerMAX** per 100W power supply using our new and improved GLX2 power supplies.

## Improved stroke spacing

24V **Tetra® PowerMAX** stroke spacing has improved on average by 35% compared to the 12V version, requiring less product thanks to the OptiLens™ X wide beam angle.



## Tetra® PowerMAX Features

- Wide 170° beam angle
- Improved luminous intensity
- Efficacy: Up to 158 lm/W
- 24 Volt DC, Class 2 (UL), Class III (IEC)
- UL Wet Rated & IP66
- 10-year limited warranty

## Tetra® PowerMAX Spacing

	Can Depth	Coverage
<b>Medium</b>	4-5" (102-127mm)	14" (356mm)
	5-6" (127-152mm)	17" (432mm)
<b>Large</b>	≥ 6" (152mm)	22" (559mm)

## Total Reliability

To ensure every **Tetra® PowerMAX** installation will operate brilliantly for years, we perform the most extensive, stringent testing in the industry. We test the LED, water and dust ingress protection, sub-system and complete system at our in-house and independent laboratories around the world. Validation of our designs, components, products and processes include high temperature, high humidity and accelerated life testing.



## Mechanical Outline & Viewing Angle

Dimensions in (inches). Metric equivalent mm

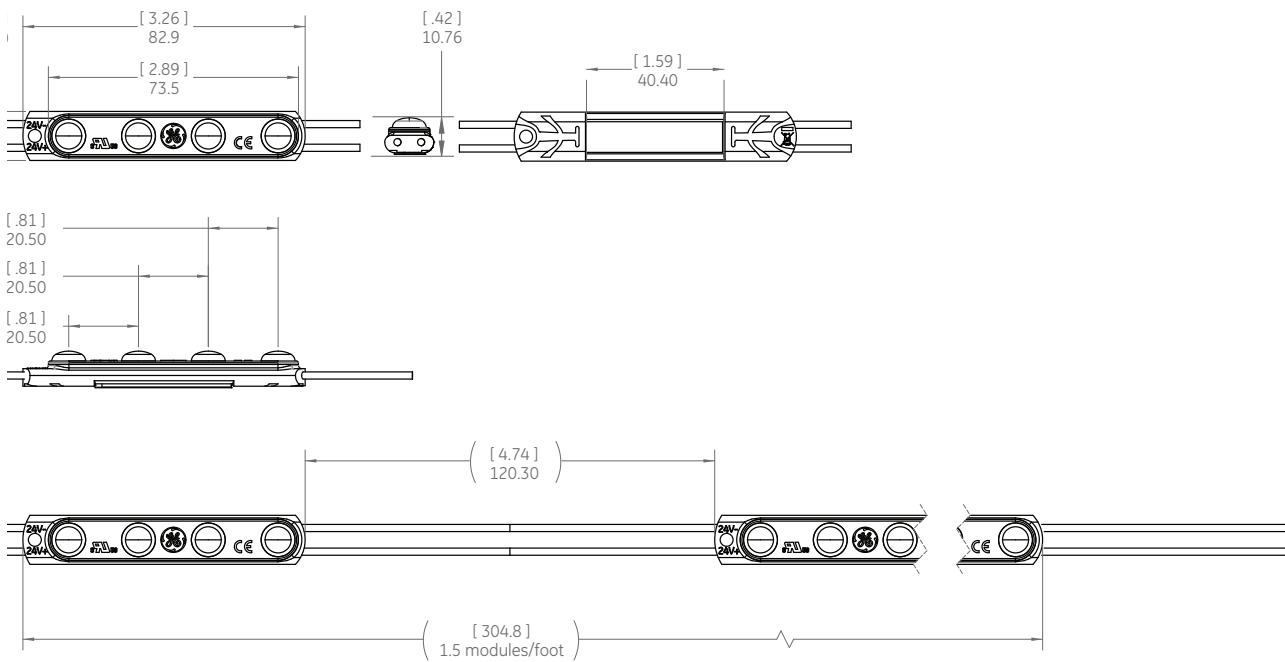

## Viewing angles

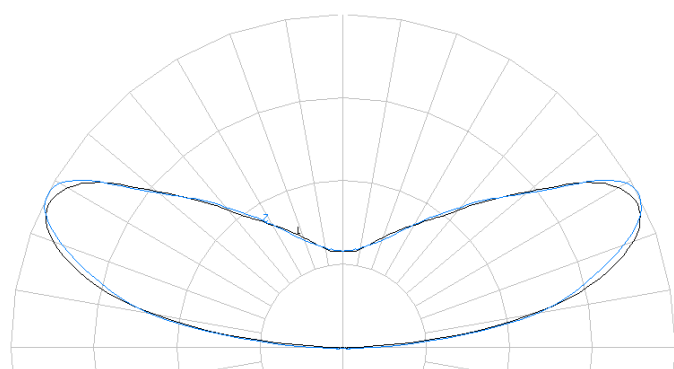

## Accessories

SKU	Description	Package quantity
GETMEC1	18 AWG Wire End Caps (0.82 mm <sup>2</sup> )	100/bag
9409	18 AWG Supply Wire (0.82 mm <sup>2</sup> )	500 ft (152.40m)/ spool
191600041	22-14 AWG Twist-on Wire Connector (0.33-2.08 mm <sup>2</sup> )	500/bag
192160004	18-14 AWG In-line Splice Connector (0.82-2.08 mm <sup>2</sup> )	500/bag

# Components

SKU	Model	Details	Color	Pkg. Quantity	Modules per strip
93051997	GEPM2471-W1	Tetra® PowerMAX 24V 7100K	White	5 Strips/Box	30 modules per strip (6 m/strip)
93118729	GEPM2465-W1	Tetra® PowerMAX 24V 6500K	Warm White	5 Strips/Box	30 modules per strip (6 m/strip)
93118730	GEPM2457-W1	Tetra® PowerMAX 24V 5700K	Warm White	5 Strips/Box	30 modules per strip (6 m/strip)
93051998	GEPM2450-W1	Tetra® PowerMAX 24V 5000K	Warm White	5 Strips/Box	30 modules per strip (6 m/strip)
93051999	GEPM2441-W1	Tetra® PowerMAX 24V 4100K	Warm White	5 Strips/Box	30 modules per strip (6 m/strip)
93052000	GEPM2432-W1	Tetra® PowerMAX 24V 3200K	Warm White	5 Strips/Box	30 modules per strip (6 m/strip)

## Technical Specifications

Model	Wavelength/ CCT	Typical Brightness Lumens/ module	Typical Brightness Lumens/Ft (Lumens/m)	Energy Consumption Module Wattage	Energy Consumption System Wattage	100W GLX Power Supply Loading	100W GLX2/ TT Power Supply Loading	Viewing Angle
GEPM2471-W1	7100K	133	200 (656)	0.84w/module	0.988w/module	64 ft (19.5 m)	68.6 ft (20.9 m)	170°
GEPM2465-W1	6500K	133	200 (656)	0.84w/module	0.988w/module	64 ft (19.5 m)	68.6 ft (20.9 m)	170°
GEPM2457-W1	5700K	133	200 (656)	0.84w/module	0.988w/module	64 ft (19.5 m)	68.6 ft (20.9 m)	170°
GEPM2450-W1	5000K	133	200 (656)	0.84w/module	0.988w/module	64 ft (19.5 m)	68.6 ft (20.9 m)	170°
GEPM2441-W1	4100K	133	200 (656)	0.84w/module	0.988w/module	64 ft (19.5 m)	68.6 ft (20.9 m)	170°
GEPM2432-W1	3200K	118	117 (578)	0.84w/module	0.988w/module	64 ft (19.5 m)	68.6 ft (20.9 m)	170°

## Additional Specifications

<b>Dimmable</b>	Yes (with dimmable power supply)				
<b>LEDs/Module</b>	4				
<b>LEDs/ft (LEDs/m)</b>	6 (19.7)				
<b>Modules/ ft. (Modules/m)</b>	1.5 (4.9)				
<b>Cutting Resolution</b>	Cut on wire between every module				
<b>Power Supply</b>	GEPS24-25-NA Input: 100-305VAC; Output: 24VDC GEPS24D-80U Input: 90-305VAC; Output: 24VDC GEPS24-100U Input: 108-305VAC; Output: 24VDC GEPS24-200U Input: 90-305VAC; Output: 24VDC GEPS24-300U Input: 108-305VAC; Output: 24VDC				
<b>Maximum Supply Wire Limits</b>		<b>18 AWG/0.82 mm<sup>2</sup> Supply Wire</b>	<b>16 AWG/1.31 mm<sup>2</sup> Supply Wire</b>	<b>14 AWG/2.08 mm<sup>2</sup> Supply Wire</b>	<b>12 AWG/3.31 mm<sup>2</sup> Supply Wire</b>
	25W Power Supply	120 ft./36.6 m	/	/	/
	80W Power Supply	20 ft./6.1 m	25 ft./7.6 m	35 ft./10.6 m	40 ft./12.1 m
	100W Power Supply	20 ft./6.1 m	25 ft./7.6 m	35 ft./10.6 m	40 ft./12.1 m
	200W Power Supply	20 ft./6.1 m	25 ft./7.6 m	35 ft./10.6 m	40 ft./12.1 m
300W Power Supply	20 ft./6.1 m	25 ft./7.6 m	35 ft./10.6 m	40 ft./12.1 m	
<b>Operating Environment</b>	-40 °C to +60 °C (-40 °F to +140 °F)				
<b>Module Dimensions (h x l x w)</b>	.42" x 3.26" x 0.57" (10.76 mm x 82.9 mm x 14.4 mm)				
<b>Warranty</b>	Limited system warranty of up to ten (10) years				
<b>System Certifications</b>	UL Recognized (C-US) #E219167, UL Classified (C-US) #E229508, CE, ROHS • IP66 rated: for dry, damp or wet location.				





# Tetra<sup>®</sup> LT

CHANNEL LETTER LIGHTING SYSTEMS

24V performance.  
Everyday value.

**Tetra<sup>®</sup> LT** — the first economical 24V LED system that meets your essential channel letter needs. Available in four different sizes, these modules deliver incredibly uniform light, allowing you to use fewer modules for faster installation and lower costs per sign. **Tetra<sup>®</sup> LT** is IP66 and UL wet rated which makes it more robust and reliable even under wet weather. A rated lifetime exceeding 50,000 hours and a standard 5-year warranty ensures that LT stands the test of time.

## Powerful OptiLens™ X

**Tetra® LT** features OptiLens™ X, our patented technology that allows for an incredible 170° viewing angle. This exclusive technology redirects otherwise wasted light to the sign face, making sure your signs shine.

## Even More Loading

Load up to 120 feet (36.5 m) or 240 modules of 24V **Tetra® LT Shallow** per 100W power supply using our new and improved GLX2 power supplies.

## Full Lineup

**Tetra® LT**, is offered in four different sizes (Deep, Deep (Extra Wire), Medium and Shallow) and four CCTs (7100K, 6500K, 5000K and 4100K) for complete flexibility.



## Tetra® LT Features

- Wide 170° beam angle
- Available in two module sizes, three lumen outputs and four CCTs
- Efficacy: up to 167 lm/W
- 24 Volt DC, Class 2 (UL), Class III (IEC)
- UL Wet Rated & IP66
- 5-year limited warranty

## Tetra® LT Spacing

	Can Depth	Coverage
LT Shallow	3" (76 mm)	7" (178 mm)
	4" - ≥5" (102 mm - ≥127 mm)	10" - 13" (254 mm - 330 mm)
LT Medium	3" (76 mm)	7" (178 mm)
	4" - ≥6" (102 mm - ≥152 mm)	10" - 16" (254 mm - 406 mm)
LT Deep LT Deep-E	4" - 5" (102 mm - 127 mm)	10" - 13" (254 mm - 330 mm)
	6" - ≥7" (152 mm - ≥178 mm)	16" - 19" (406 mm - 483 mm)

# Total Reliability

To ensure every **Tetra® LT** installation will operate brilliantly for years, we perform the most extensive, stringent testing in the industry. We test the LED, water and dust ingress protection, sub-system and complete system at our in-house and independent laboratories around the world. Validation of our designs, components, products and processes include high temperature, high humidity and accelerated life testing.



# Mechanical Outline & Viewing Angle

Dimensions in (inches). Metric equivalent mm

GELTD24XX-1  
GELTD24XX-1E

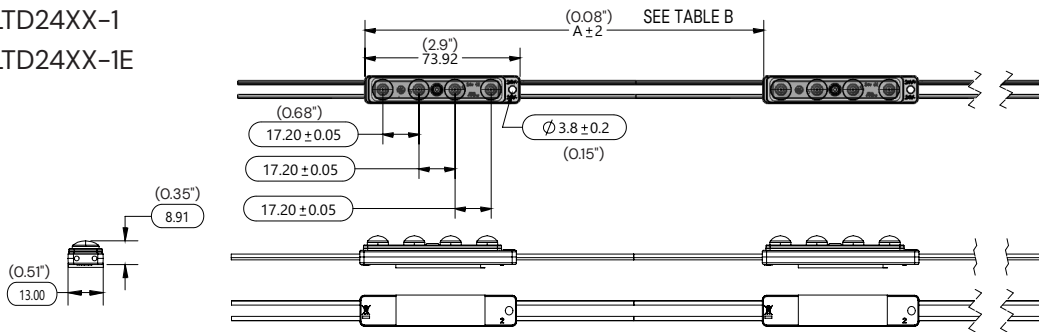

TABLE B:

ITEM	A	NOTES
DEEP	218 mm	4.6 MOD./M
DEEP-EXT	305 mm	3.3 MOD./M

GELTM24XX-1  
GELTS24XX-1

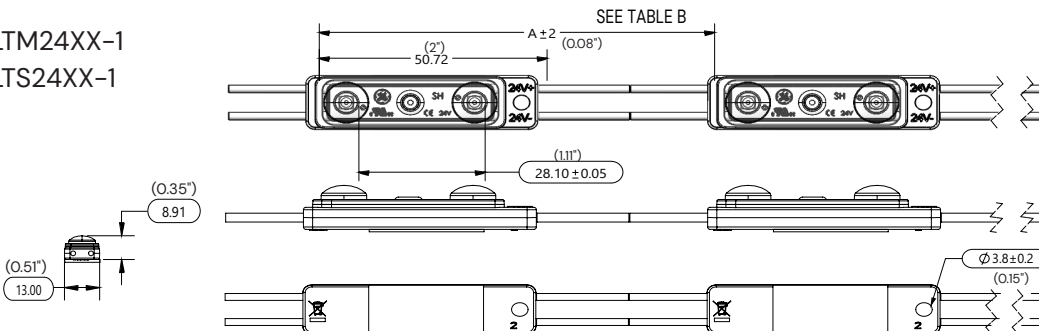

TABLE B:

ITEM	A	NOTES
SHALLOW	152 mm	6.6 MOD./M
MEDIUM	203 mm	5 MOD./M

GELTD24XX-1  
GELTD24XX-1E

GELTM24XX-1

GELTS24XX-1

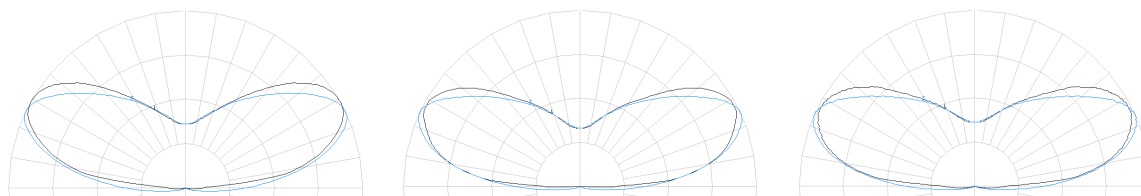

# Components

SKU	Order Code	Description	Color	Box Quantity	Strip Quantity
93146577	GELTD2471-1	Tetra®LT Deep 7100K	White	4 strips/box	112 modules per strip
93146578	GELTD2465-1	Tetra®LT Deep 6500K	Warm White	4 strips/box	112 modules per strip
93146579	GELTD2450-1	Tetra®LT Deep 5000K	Warm White	4 strips/box	112 modules per strip
93146580	GELTD2441-1	Tetra®LT Deep 4100K	Warm White	4 strips/box	112 modules per strip
93146581	GELTD2471-1E	Tetra®LT Deep (Extra Wire) 7100K	White	4 strips/box	80 modules per strip
93146582	GELTD2465-1E	Tetra®LT Deep (Extra Wire) 6500K	Warm White	4 strips/box	80 modules per strip
93146583	GELTD2450-1E	Tetra®LT Deep (Extra Wire) 5000K	Warm White	4 strips/box	80 modules per strip
93146584	GELTD2441-1E	Tetra®LT Deep (Extra Wire) 4100K	Warm White	4 strips/box	80 modules per strip
93146573	GELTM2471-1	Tetra®LT Medium 7100K	White	4 strips/box	120 modules per strip
93146574	GELTM2465-1	Tetra®LT Medium 6500K	Warm White	4 strips/box	120 modules per strip
93146575	GELTM2450-1	Tetra®LT Medium 5000K	Warm White	4 strips/box	120 modules per strip
93146576	GELTM2441-1	Tetra®LT Medium 4100K	Warm White	4 strips/box	120 modules per strip
93146559	GELTS2471-1	Tetra®LT Shallow 7100K	White	4 strips/box	160 modules per strip
93146560	GELTS2465-1	Tetra®LT Shallow 6500K	Warm White	4 strips/box	160 modules per strip
93146571	GELTS2450-1	Tetra®LT Shallow 5000K	Warm White	4 strips/box	160 modules per strip
93146572	GELTS2441-1	Tetra®LT Shallow 4100K	Warm White	4 strips/box	160 modules per strip

## Technical Specifications

	CCT	Typical Brightness (Lumens/module)	Typical Brightness Lumens/ft (Lumens/m)	Modules / Ft (m)	Efficacy/ Module (Lumens/W)	Energy Consumption Module Wattage	Energy Consumption System Wattage	GLX2 Power Supply Loading (m/100W)	Viewing Angle
GELTD2471-1	7100K	173	242 (795)	1.4 (4.6)	160	1.08W/module	1.27W/module	17m/ 80 modules	170°
GELTD2465-1	6500K	173	242 (795)	1.4 (4.6)	160	1.08W/module	1.27W/module	17m/ 80 modules	170°
GELTD2450-1	5000K	180	252 (827)	1.4 (4.6)	167	1.08W/module	1.27W/module	17m/ 80 modules	170°
GELTD2441-1	4100K	180	252 (827)	1.4 (4.6)	167	1.08W/module	1.27W/module	17m/ 80 modules	170°
GELTD2471-1E	7100K	173	173 (568)	1 (3.3)	160	1.08W/module	1.27W/module	24m/80 modules	170°
GELTD2465-1E	6500K	173	173 (568)	1 (3.3)	160	1.08W/module	1.27W/module	24m/80 modules	170°
GELTD2450-1E	5000K	180	180 (591)	1 (3.3)	167	1.08W/module	1.27W/module	24m/80 modules	170°
GELTD2441-1E	4100K	180	180 (591)	1 (3.3)	167	1.08W/module	1.27W/module	24m/80 modules	170°
GELTM2471-1	7100K	113	170 (558)	1.5 (5)	154	0.72W/module	0.85W/module	24m/120 modules	170°
GELTM2465-1	6500K	113	170 (558)	1.5 (5)	154	0.72W/module	0.85W/module	24m/120 modules	170°
GELTM2450-1	5000K	115	173 (566)	1.5 (5)	156	0.72W/module	0.85W/module	24m/120 modules	170°
GELTM2441-1	4100K	115	173 (566)	1.5 (5)	156	0.72W/module	0.85W/module	24m/120 modules	170°
GELTS2471-1	7100K	58	116 (379)	2 (6.6)	161	0.36W/module	0.42W/module	37m/240 modules	170°
GELTS2465-1	6500K	58	116 (379)	2 (6.6)	161	0.36W/module	0.42W/module	37m/240 modules	170°
GELTS2450-1	5000K	60	120 (394)	2 (6.6)	167	0.36W/module	0.42W/module	37m/240 modules	170°
GELTS2441-1	4100K	60	120 (394)	2 (6.6)	167	0.36W/module	0.42W/module	37m/240 modules	170°

## Additional Specifications

<b>Dimmable</b>	Yes (with dimmable power supply)				
<b>Cutting Resolution</b>	Cut on wire between every module				
<b>Power Supply Voltage</b>	24VDC				
<b>Power Supply Part Numbers</b>	GEPS24-25U Input: 100-305VAC; Output: 24VDC GEPS24D-60U Input: 120-277VAC; Output: 24VDC GEPS24-100U Input: 108-305VAC; Output: 24VDC GEPS24-150U Input: 176-305VAC; Output: 24VDC GEPS24-200U-EU Input: 200-240VAC; Output: 24VDC GEPS24-300U Input: 108-305VAC; Output: 24VDC				
<b>Maximum Supply Wire Limits</b>		<b>18 AWG/0.82 mm<sup>2</sup> Supply Wire</b>	<b>16 AWG/1.31 mm<sup>2</sup> Supply Wire</b>	<b>14 AWG/2.08 mm<sup>2</sup> Supply Wire</b>	<b>12 AWG/3.31 mm<sup>2</sup> Supply Wire</b>
	25W Power Supply	120 ft./36.6 m	-	-	-
	60W Power Supply	20 ft./6.1 m	25 ft./7.6 m	35 ft./10.6 m	40 ft./12.1 m
	100W Power Supply	20 ft./6.1 m	25 ft./7.6 m	35 ft./10.6 m	40 ft./12.1 m
	150W Power Supply	20 ft./6.1 m	25 ft./7.6 m	35 ft./10.6 m	40 ft./12.1 m
	200W Power Supply	20 ft./6.1 m	25 ft./7.6 m	35 ft./10.6 m	40 ft./12.1 m
300W Power Supply	20 ft./6.1 m	25 ft./7.6 m	35 ft./10.6 m	40 ft./12.1 m	
<b>Operating Environment</b>	-40 °C to +60 °C (-40 °F to +140 °F)				
<b>Warranty</b>	Limited system warranty of up to five (5) years				
<b>Module Dimensions (h x l x w) mm (inches)</b>	8.91 x 74 x 13 (0.35 x 2.90 x 0.51) 8.91 x 51 x 13 (0.35 x 2 x 0.51)				
<b>System Certifications</b>	UL Recognized (c-us) #E219167, UL Certified Retrofit Sign Conversion Kit (c-us) #E229508, CE, UKCA, ROHS, IP66 rated: for dry, damp or wet location.				



LED.com

© 2023 Current Lighting Solutions, LLC. All rights reserved. Information and specifications subject to change without notice. All values are design or typical values when measured under laboratory conditions.

(Rev 06/06/23)

SIGN310EU



# Select TX<sup>®</sup> Gen 3

CHANNEL LETTER LIGHTING SYSTEMS

Trusted technology with exceptional value

The third generation of the **Select TX<sup>®</sup>** family offers a solution for your everyday channel letter needs, with loading increased by 25% compared to the second generation. **Select TX<sup>®</sup>** also features constant current technology, which ensures consistent module brightness, from the first module on the string to the last. Now available in four different sizes and three different colors.

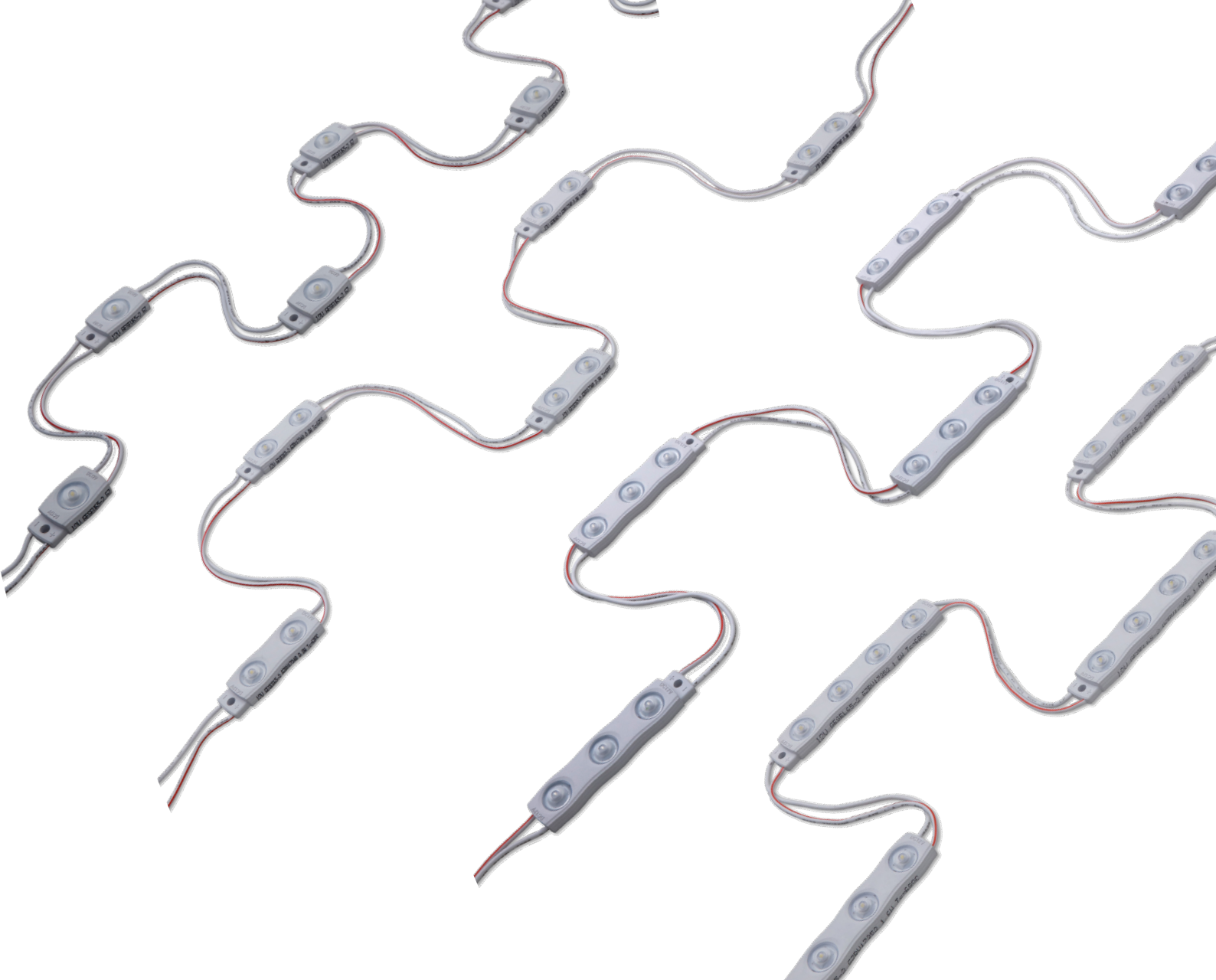

## Layout guide

### GESEV65-3

Letter size	Can Depth	Coverage
Small	2-3" (51-76mm)	4-7" (102-178mm)
	3-4" (76-102mm)	6-10" (152-254mm)
Medium	4-5" (102-127mm)	9-13" (229-330mm)

### GESEMXX-3

Letter size	Can Depth	Coverage
Medium	4-5" (102-127mm)	9-13" (229-330mm)
	5-6" (127-152mm)	12-16" (305-406mm)
Large	≥6" (152mm)	15-19" (381-483mm)

### GESES65-3

Letter size	Can Depth	Coverage
Small	3-4" (76-102mm)	6-10" (152-254mm)
	4-5" (102-127mm)	9-13" (229-330mm)
Medium	5-6" (127-152mm)	12-16" (305-406mm)

### GESEL65-3 / GESEL65-3E

Letter size	Can Depth	Coverage
Medium	4-5" (102-127mm)	9-13" (229-330mm)
	5-6" (127-152mm)	12-16" (305-406mm)
Large	≥6" (152mm)	15-22" (381-559mm)

# Total Reliability

To ensure every **Select TX® Gen 3** installation will operate brilliantly for years, we perform the most extensive, stringent testing in the industry. We test the LED, water and dust ingress protection, sub-system and complete system at our in-house and independent laboratories around the world. Validation of our designs, components, products and processes include high temperature, high humidity and accelerated life testing.

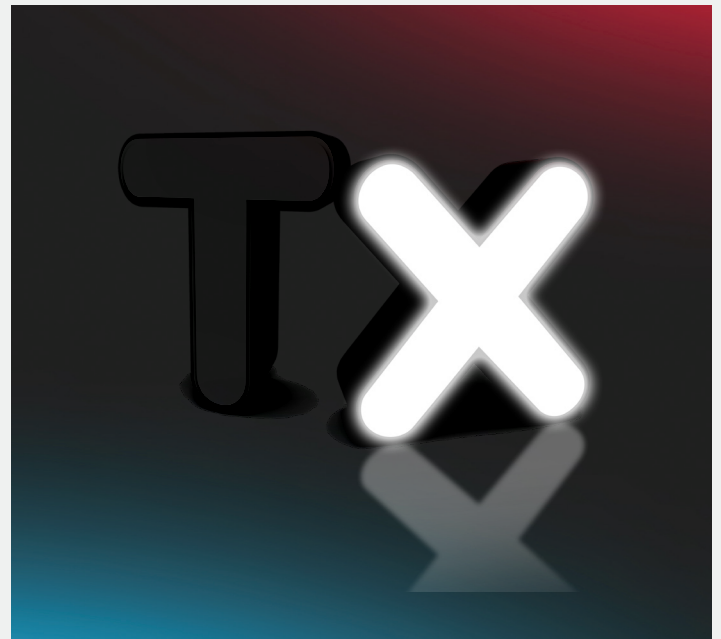

## Mechanical Outline & Viewing Angle

Dimensions in mm. Metric equivalent (in)

GESEV65-3

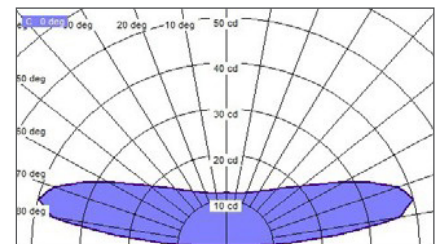
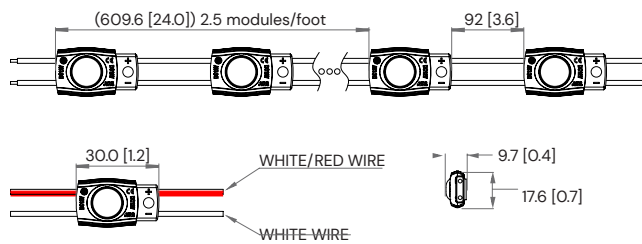

GESES65-3

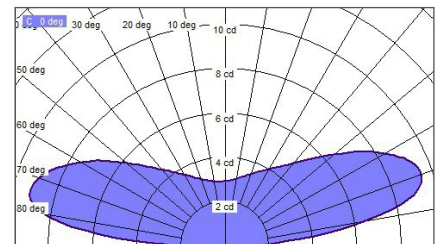
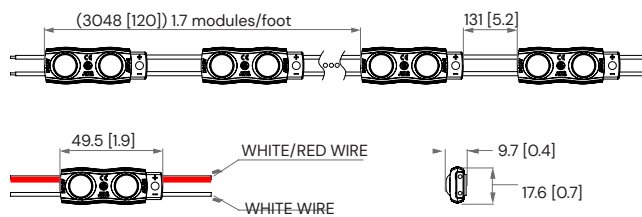

GESEM65-3

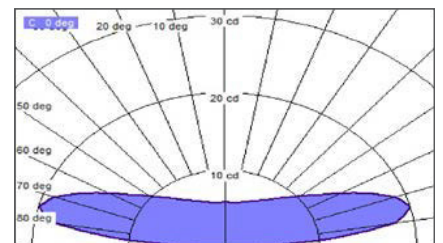
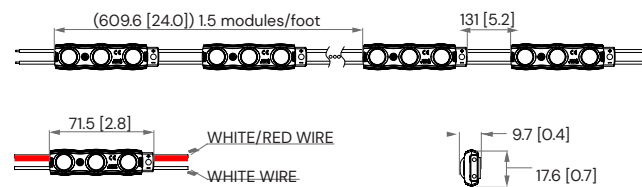

GESEL65-3  
GESEL65-3E

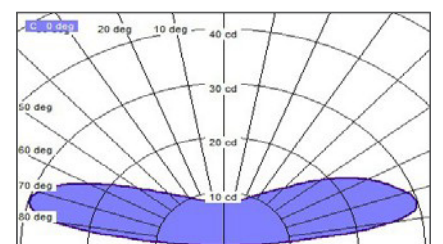
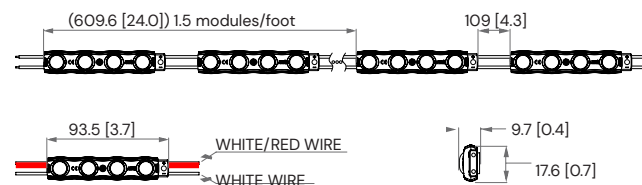

# Technical Specifications – Whites

SKU	93120540	93120541	93120542	93120543	93135353
Description	GESEV65-3	GESES65-3	GESEM65-3	GESEL65-3	GESEL65-3E
	Very Small	Small	Medium	Large	Large
Color Temperature (Wavelength)	6500K	6500K	6500K	6500K	6500K
Typical Brightness* (lm/module)	40	80	120	160	160
Typical Brightness* lm/ft. (lm/m.)	100 (328.1)	136 (446.2)	180 (590.6)	240 (787.4)	160 (525)
LEDs/Module	1	2	3	4	4
Modules/Foot	2.5 (8.2)	1.7 (5.6)	1.5 (5)	1.5(5)	1 (3.3)
Power Supply Loading – 60W	60 ft (18.3 m) (150 modules)	44.7 ft (13.6 m) (76 modules)	33.4 ft (10.2 m) (50 modules)	25.3 ft (7.7 m) (38 modules)	38 ft (11.6 m) (38 modules)
Viewing Angle	165°	165°	165°	165°	165°
Energy Consumption* (Module Wattage)	0.40w/module	0.80w/module	1.20w/module	1.60w/module	1.60w/module
Energy Consumption* (System Wattage)	0.47w/module	0.94w/module	1.41w/module	1.88w/module	1.88w/module
Efficacy (Lumens/Watt)	100	100	100	100	100
Dimensions (h x l x w) inches- module	1.04 x 0.69 x 0.34	1.91 x 0.69 x 0.34	2.78 x 0.69 x 0.34	3.65 x 0.69 x 0.34	3.65 x 0.69 x 0.34
Dimensions (h x l x w) mm- module	26.6 X 17.6 X 8.7	48.6 X 17.6 X 8.7	70.6 X 17.6 X 8.7	92.6 X 17.6 X 8.7	92.6 X 17.6 X 8.7
Quantity per package (ft./box) (Strips/box)	600 ft (182.88 m) (10 strips/box, 2 strips/bag)	600 ft (182.88 m) (12 strips/box, 2 strips/bag)	600 ft (182.88 m) (12 strips/box, 2 strips/bag)	600 ft (182.88 m) (12 strips/box, 2 strips/bag)	600 ft (182.88 m) (12 strips/box, 2 strips/bag)
Modules/Strip	150	85	75	75	75

# Technical Specifications – Colors

SKU	93083210	93083212	93083211
Description	GESEMRD-2	GESEMBL-2	GESEMGL-2
	Medium Red	Medium Blue	Medium Green
Color Temperature (Wavelength)	625nm	460nm	520nm
Typical Brightness (lm/module)	15.6	12.0	41.0
Typical Brightness lm/ft. (lm/m.)	23.4 (77.1)	18.0 (59.1)	61.5 (203.4)
LEDs/Module	3	3	3
Modules/Foot	1.5 (5)	1.5 (5)	1.5 (5)
Power Supply Loading – 60W	67 ft (20 m) (100 modules)	40 ft (12 m) (60 modules)	53 ft (16 m) (80 modules)
Viewing Angle	165°	165°	165°
Energy Consumption* (Module Wattage)	0.52w/module	0.87w/module	0.67w/module
Energy Consumption* (System Wattage)	0.61w/module	0.92w/module	0.80w/module
Efficacy (Lumens/Watt)	30	14	61
Dimensions (h x l x w) inches- module	2.78 x 0.69 x 0.34	2.78 x 0.69 x 0.34	2.78 x 0.69 x 0.34
Dimensions (h x l x w) mm- module	70.6 X 17.6 X 8.7	70.6 X 17.6 X 8.7	70.6 X 17.6 X 8.7
Quantity per package (ft./box) (Strips/box)	600 ft (182.88 m) (12 strips, 1 strips/bag)	600 ft (182.88 m) (12 strips, 1 strips/bag)	600 ft (182.88 m) (12 strips, 1 strip/bag)
Modules/Strip	75	75	75

\*Typical performance +/- 10%

# Additional Specifications

<b>Dimmable</b>	Yes (with dimmable power supply)				
<b>Cutting Resolution</b>	Cut on wire between every module				
<b>Power Supply voltage</b>	12VDC				
<b>Power Supply Part Numbers</b>	GEPS12-25U-EU Input:220-240VAC; Ouput: 12VDC GEPS12-60U-GL Input: 108-305VAC; Output: 12VDC GEPS12-150U-EU Input: 100-240VAC; Output: 12VDC GEPS12-200U-EU Input: 200-240VAC; Output: 12VDC				
<b>Maximum Supply Wire Limits</b>		<b>18 AWG/0.82 mm<sup>2</sup> Supply Wire</b>	<b>16 AWG/1.31 mm<sup>2</sup> Supply Wire</b>	<b>14 AWG/2.08 mm<sup>2</sup> Supply Wire</b>	<b>12 AWG/3.31 mm<sup>2</sup> Supply Wire</b>
	25W Power Supply	20 ft./6.1 m	25 ft./7.6 m	35 ft./10.6 m	40 ft./12.1 m
	60W Power Supply	20 ft./6.1 m	25 ft./7.6 m	35 ft./10.6 m	40 ft./12.1 m
	150W Power Supply	20 ft./6.1 m	25 ft./7.6 m	35 ft./10.6 m	40 ft./12.1 m
	200W Power Supply	20 ft./6.1 m	25 ft./7.6 m	35 ft./10.6 m	40 ft./12.1 m
<b>Operating Environment</b>	-40 °C to +60 °C (-40 °F to +140 °F)				
<b>Warranty</b>	Limited system warranty of up to five (5) years				
<b>System Certifications</b>	UKCA, UL Recognized #E219167, UL Classified #E229508, CSA Approved #216319, RCM, Class III, China Rohs II IP66. Suitable for dry and damp locations.				



LED.com

© 2023 Current Lighting Solutions, LLC. All rights reserved. Information and specifications subject to change without notice. All values are design or typical values when measured under laboratory conditions.

(Rev 06/06/23)

SIGN269EU



# Select TX<sup>®</sup> Cuttable Light Bar

CABINET SIGN LIGHTING SYSTEMS

Flexible and Customizable  
LED Solution

Select TX<sup>®</sup> Cuttable Light Bar is a product designed with the ability to be cut every 3¼" / 83 mm, allowing signmakers to create indoor illuminated signage and displays that fit their vision.

# Select TX<sup>®</sup> Cuttable Light Bar

## Features

- Wide 160° beam angle
- Aluminium PCB for enhanced thermal dissipation and longer LED life
- CRI >Ra80 allows much better colour rendition in signage and advertising cases
- Efficacy: up to 100 lm/W
- 24 Volt DC, Class 2 (UL), Class III (IEC)
- IP20
- 5-year limited warranty

## Technical Summary

Specification	
Input Voltage	24VDC
Lumens	1100 lm
Power Consumption	10.8 W
Lifetime @L70B50	50,000 Hrs
Operating Ambient Temperature	-25°C to +60°C
Storage Temperature	-25°C to +70°C
Environmental protection	IP20

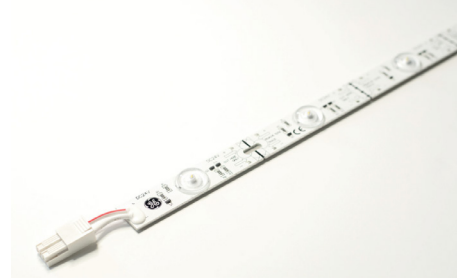

## Product Dimensions

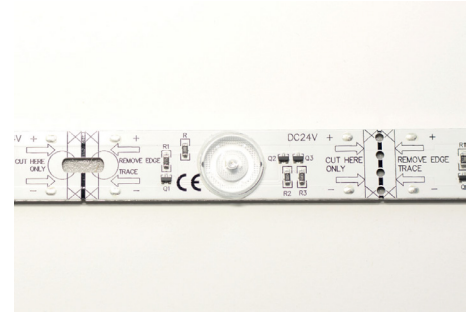
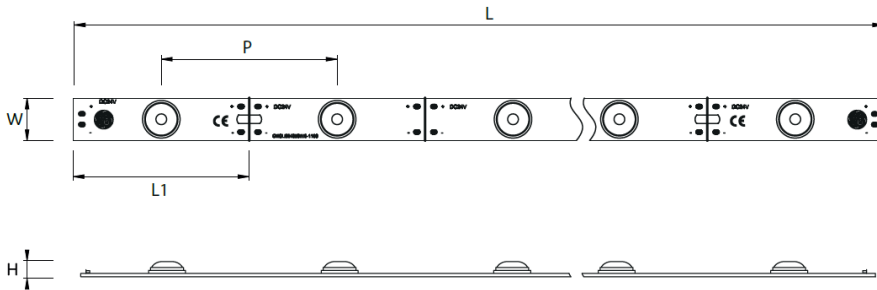

SKU	Length (L)	Width (W)	Height (D)	L1	P
GECLB2465-1160-2	1162 mm	20 mm	8.5 mm	83 mm	83 mm

## Specifications

SKU	Description	CCT	Rated Luminous Flux (lm)	LED Length (mm)	N° of	Control
93135341	GECLB2465-1160-2	6500K	1100	1162	14	Static

## Accessories

SKU	Type	Description
93135342	GECLB-CTK-0250-2	Connector Lead Kit 250 mm
93135343	GECLB-CTK-1500-2	Connector Lead Kit 1500 mm
93135344	GECLB-CTK-0100-2	Power Lead Kit 100 mm

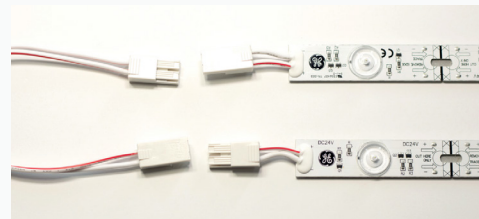

Power Lead Kit 100 mm

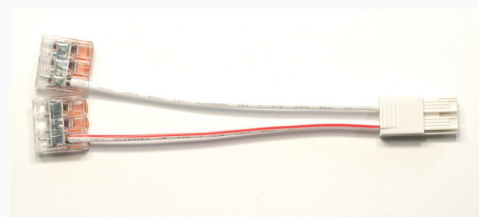

Connector Lead Kit



# Tetra<sup>®</sup> Rigid Light Bar

CABINET SIGN LIGHTING SYSTEMS

Flexible and Customizable  
LED Solution

Tetra<sup>®</sup> Rigid light Bar is a product designed for shallow-box indoor signs. It comes available in three lengths for fast, daisy-chainable installation for the illumination of large surface areas.









# Tetra<sup>®</sup> LED Tape Gen 2

CHANNEL LETTER LIGHTING SYSTEMS

## Labor Saving LED Solution

**Tetra<sup>®</sup> LED Tape** installs easily and quickly, slashing labor costs. Designed for applications as shallow as 1 inch, it includes a self-adhesive backing—which eliminates screw attachments, can be cut every two inches, and is available with electrical connectors that make assembly a snap. For applications requiring more light, Tetra<sup>®</sup> Tape is also offered in HO. Roll out the savings with our innovative solution.

## Quick and Easy

- Quick and simple installation using clamp-on connectors
- Easy mounting with self-adhesive backing: no screws required
- Can be cut every 2 inches at marked points
- Electrical connectors means no soldering required
- Applications: shallow channel letter, backlit halo letter, routed acrylic block letter
- 3-year warranty
- IP66 with an enclosure
- 12VDC
- Available in regular and high output (white only)

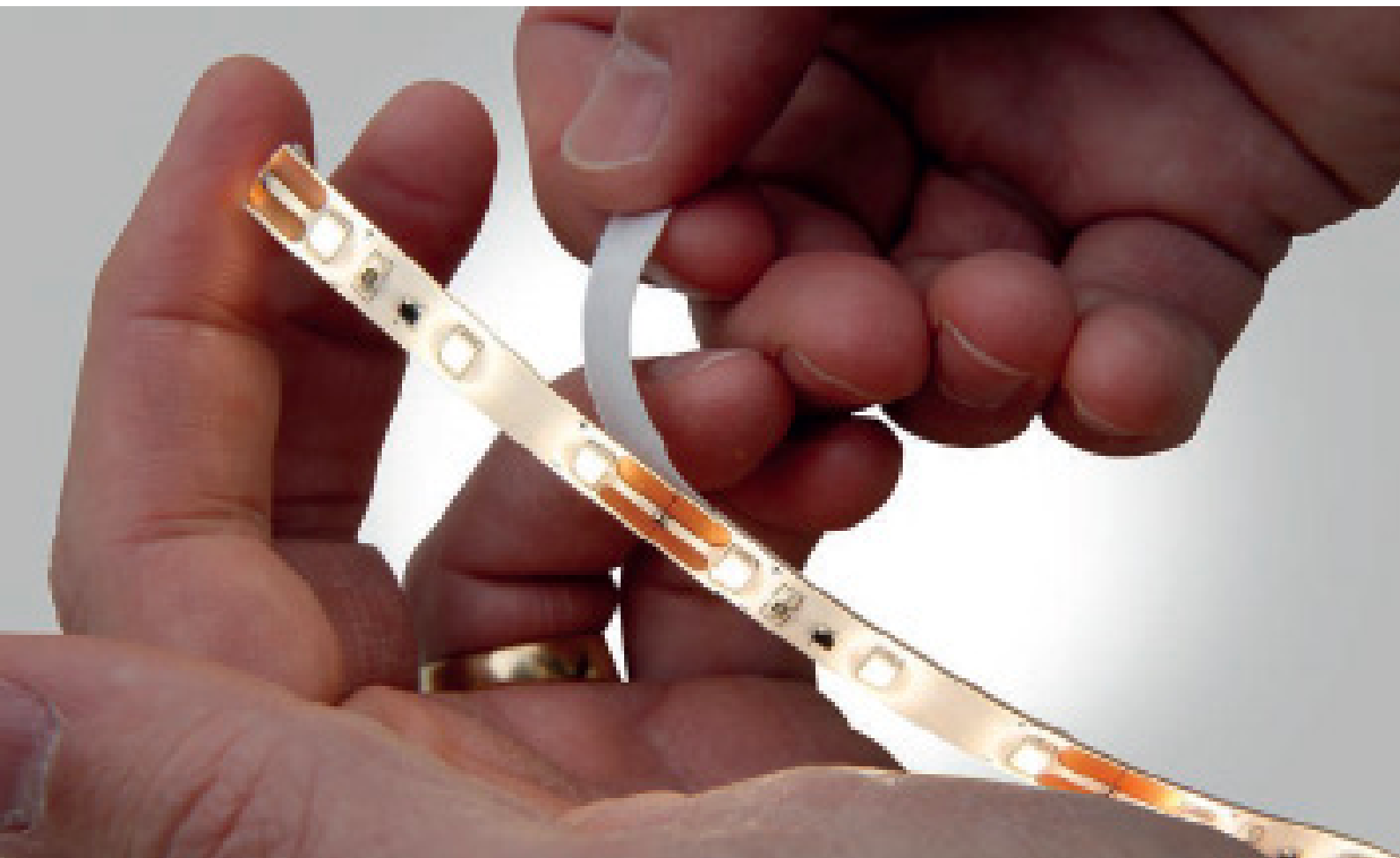

## Total Reliability

To ensure every **Tetra® LED Tape Gen 2** installation will operate brilliantly for years, we perform the most extensive, stringent testing in the industry. We test the LED, water and dust ingress protection, sub-system and complete system at our in-house and independent laboratories around the world. Validation of our designs, components, products and processes include high temperature, high humidity and accelerated life testing.

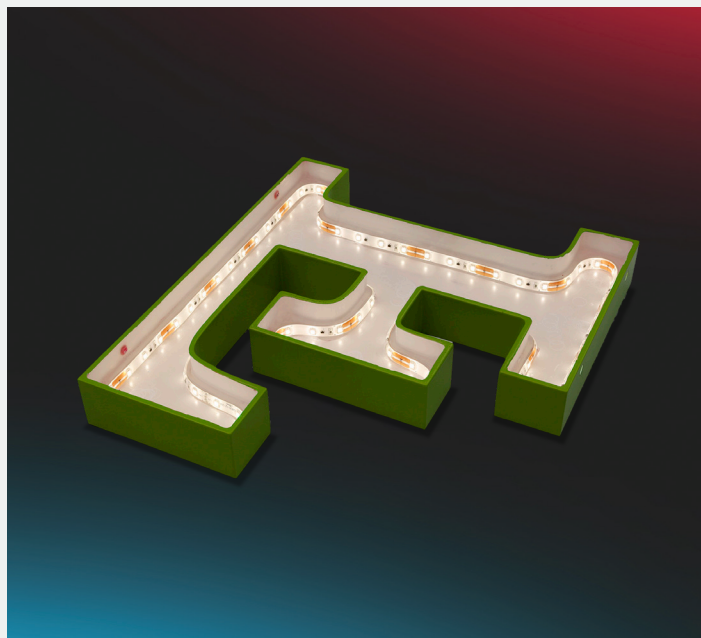

## Tape Dimensions

inches (mm)

Height	Width	Length
0.085" (2.16)	0.315" (8.00)	16'4" (4978)

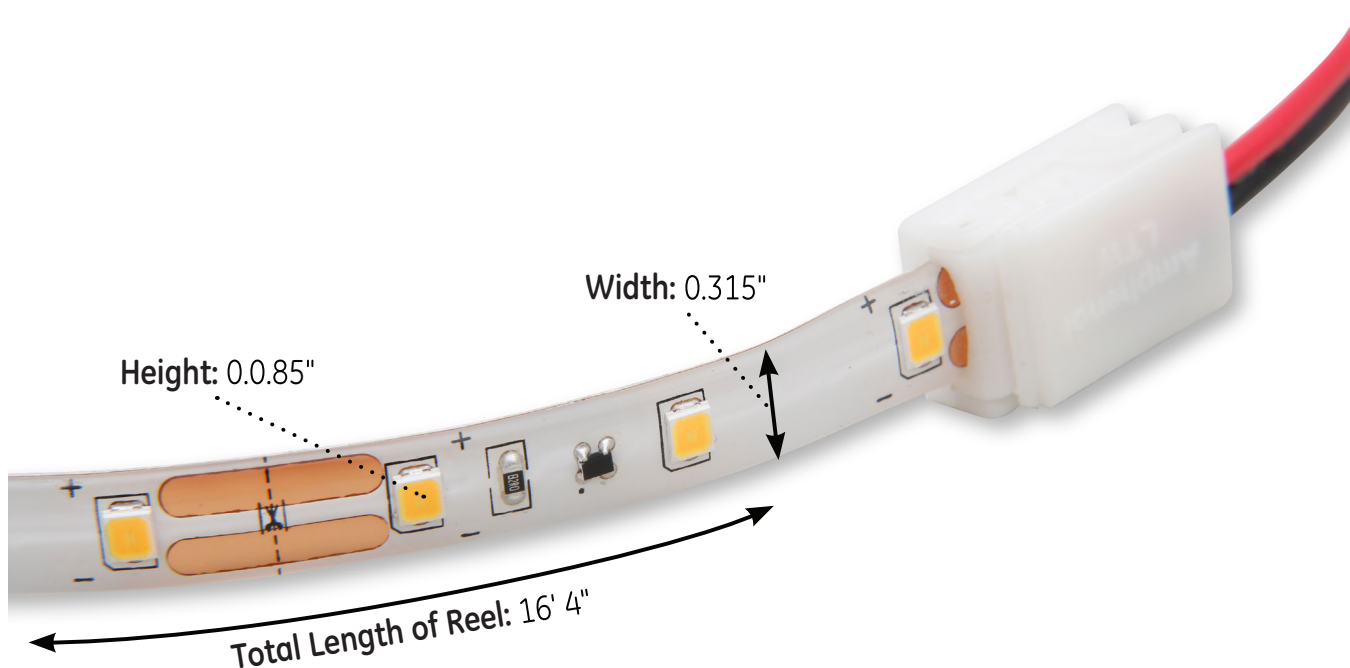

# Components

SKU	Model	Led color	Wavelength/CCT	Lumens/ft (Typical)	Energy Consumption (Watts per foot)	Power Supply Loading (Length/60W)
93110239	GETP35-2	Warm White	3500K	146	1.37	32.8 ft/10 m
93110240	GETP40-2	Warm White	4000K	146	1.37	32.8 ft/10 m
93110241	GETP50-2	Warm White	5000K	147	1.37	32.8 ft/10 m
93110242	GETP60-2	White	6000K	146	1.37	32.8 ft/10 m
93110243	GETPRD-2	Red	625nm	38	1.08	39 ft/12 m
93110244	GETPGL-2	Green	527nm	70	0.75	49 ft/15 m
93110245	GETPBL-2	Blue	460nm	21	1.37	32.8 ft/10 m
93109875	GETPH35-2	Warm White	3500K	327	3.22	13 ft/4 m
93110236	GETPH40-2	Warm White	4000K	327	3.22	13 ft/4 m
93110237	GETPH50-2	Warm White	5000K	329	3.22	13 ft/4 m
93110238	GETPH60-2	White	6000K	325	3.22	13 ft/4 m

# Technical Specifications

<b>Dimmable</b>	Yes (with dimmable power supply)				
<b>Rolls per box</b>	5				
<b>Cutting Resolution</b>	Can be cut every 2 inches at marked points				
<b>Power Supply</b>	GEPS12-25U-NA Input: 108-305 VAC; Output: 12VDC GEPS12-60U-NA Input: 108-305 VAC; Output: 12VDC GEPS12D-60U Input: 90-305 VAC; output 12VDC GEPS12-60U-GL Input: 108-305 VAC output: 12VDC GEPS12-180U-NA Input: 108-305 VAC; Output: 12VDC				
<b>Maximum Supply Wire Limits</b>		<b>18 AWG/0.82 mm<sup>2</sup> Supply Wire</b>	<b>16 AWG/1.31 mm<sup>2</sup> Supply Wire</b>	<b>14 AWG/2.08 mm<sup>2</sup> Supply Wire</b>	<b>12 AWG/3.31 mm<sup>2</sup> Supply Wire</b>
	25W Power Supply	120 ft./36.6 m	/	/	/
	60W Power Supply	20 ft./6.1 m	25 ft./7.6 m	35 ft./10.6 m	40 ft./12.1 m
	180W Power Supply	20 ft./6.1 m	25 ft./7.6 m	35 ft./10.6 m	40 ft./12.1 m
<b>Operating Environment</b>	-40 °C to +60 °C (-40 °F to +140 °F)				
<b>Reel Dimensions (H x W x L)</b>	.085" x .315" x 16' 4" (2.16 x 8.00 x 4978 mm)				
<b>Warranty</b>	Limited system warranty of up to three (3) years				
<b>System Certifications</b>	UL Recognized #E219167, UL Classified #E229508, CE, Class III, RoHS • IP66 rated with separate enclosure for dry, damp locations.				

# Components

SKU	Description	Long Description	Package Description
93026288	GETPLCN54-1	Lead Connector	10/bag
93026289	GETPLCN54-1	Jumper Connector	10/bag
GETMEC1	GETMEC1	18 AWG Wire End Caps (0.82 mm2)	100/bag
9409	9409	18 AWG Supply Wire (0.82 mm2)	500 ft (152.40 m)/spool
191600041	191600041	22-14 AWG Twist-on Wire Connector (0.33-2.08 mm <sup>2</sup> )	500/bag
192160004	192160004	18-14 AWG In-line Splice Connector (0.82-2.08 mm <sup>2</sup> )	500/bag



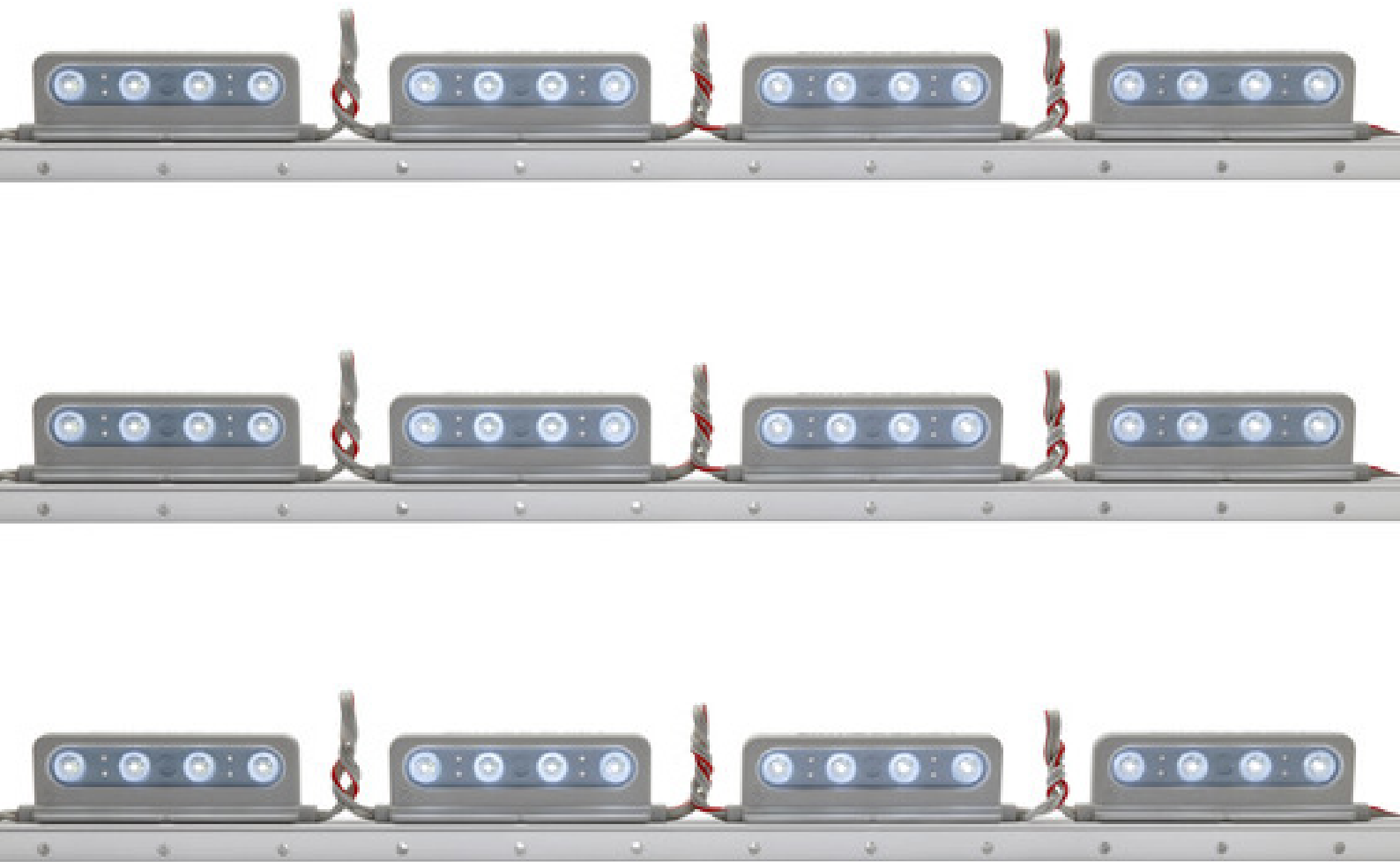

# Tetra<sup>®</sup> Snap DS

CABINET SIGN LIGHTING SYSTEMS

For those who don't have  
time to screw around

**Tetra<sup>®</sup>Snap DS** — our most innovative cabinet sign solution ever. Snap is a double-sided module that snaps into a screwless aluminum extrusion, allowing module spacing and brightness levels to be customized on-the-fly. **Tetra<sup>®</sup>Snap DS** is a one-size-fits-all product for double-sided cabinet signs. Say goodbye to stocking dozens of sticks. Say hello to **Tetra<sup>®</sup>Snap DS**.

## Bright as a new penny

**Tetra® Snap DS** modules pump out 400 lumens each, and can be installed at three different spacings, for a maximum 1000 lumens per foot. No other cabinet sign product comes close.

## Load 'em up

Load 33 **Tetra® Snap DS** modules per 100W power supply, enough to light a single 163 x 203 cm sign.

## One product to rule them all

The most flexible product on the market, **Tetra® Snap DS** is suitable for cabinets ranging from 25 cm to well over 92 cm in depth, all with the same material.

You may be wondering what the catch is. But it only gets better. Here's how to install Snap:

- Step 1: Snap modules into extrusion.
- Step 2: Install extrusion into sign.
- Step 3: Plug in. Enjoy results.

No catch. **Tetra® Snap**.

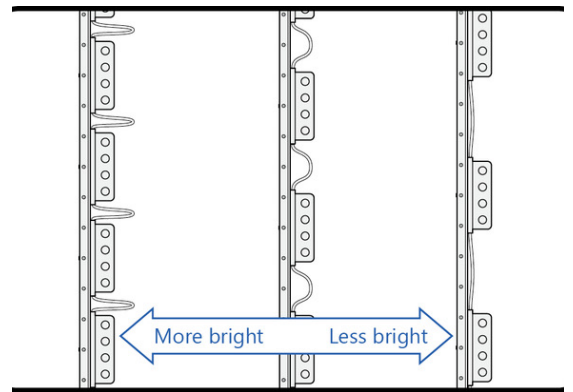
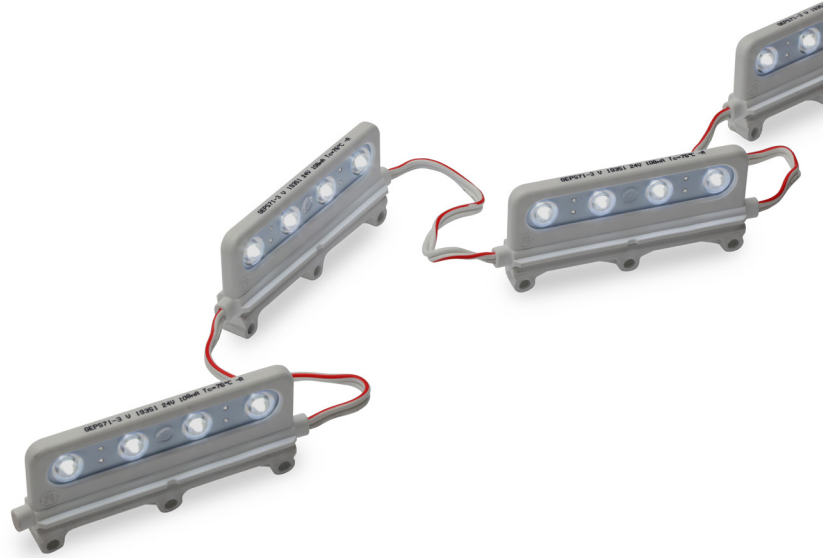

## Tetra® Snap DS Features

- Wide 170° beam angle
- Efficacy: Up to 152 lm/W
- 24 Volt DC, Class 2 (UL), Class III (IEC)
- 10-year limited warranty

## Spacing Guidelines

	Depth	Max stroke
Double sided	10" - <12" 25 cm - <31 cm	13" 31 cm
	12" - <14" 31 cm - <36 cm	16" 41 cm
	14" - <16" 36 cm - <41 cm	18" 46 cm
	>16" <41 cm	20" 51 cm

# Brightness Chart

Our Brightness Chart provides a clear explanation of the light levels you can achieve using the same Tetra Snap modules and rail, as well as your customer's predicted\* happiness levels.

\* Happiness levels estimated by our proprietary artificial intelligence algorithm  
 † Marketing manager

Brightness level	Lumens per foot	Your inventory level	Your customer's happiness
Regular output	1968.5	Low	☺
High output	750	Still low	☺ ☺
Ludicrous mode	1000	Yup, still low	☺ ☺ ☺

# Mechanical Outline

Dimensions in (inches). Metric equivalent mm

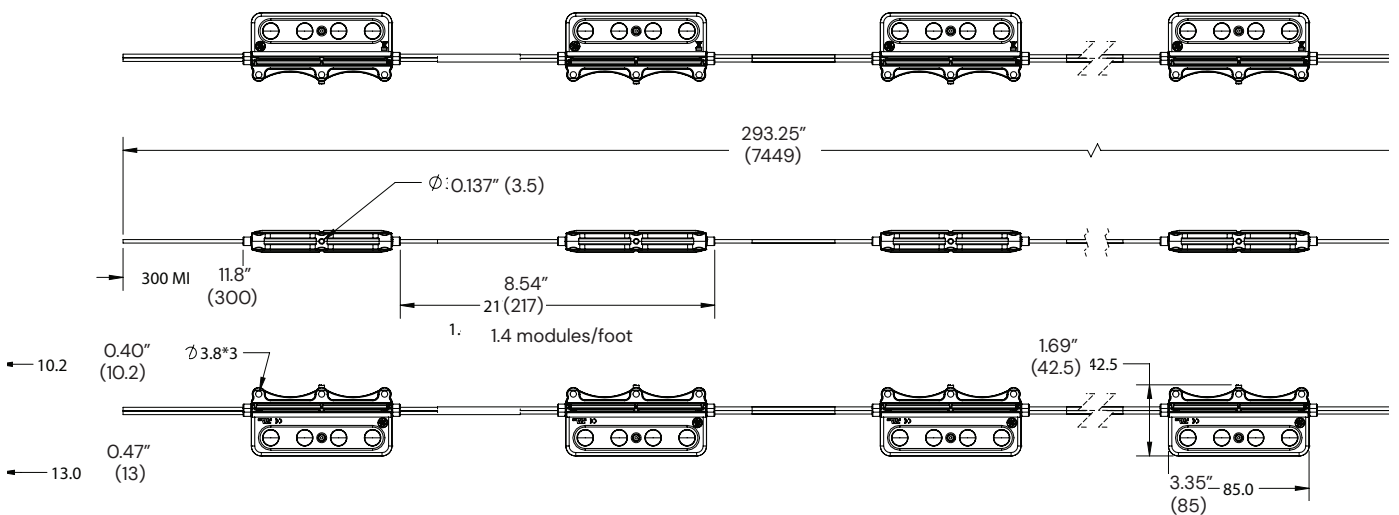

# Accessories

SKU	Model number	Description	Package Quantity
93130907	GEDSIC-3	Interconnector (to join two sections of rail)	20
93130908	GEDSTC-3	T-connector (to install perpendicular rails in a grid pattern)	20
93130909	GEDSFE-3	Frame endcap (for mounting directly to sign structures)	40
93130910	GEDSSE-3	Socket endcap (for mounting in existing sockets)	40
93128550	GEDSRL08-3	30.5 cm. rail	20

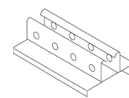

GEDSIC-3



GEDSTC-3



GEDSFE-3



GEDSSE-3

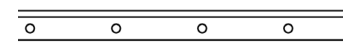

GEDSRL08-3

# Module Dimensions

Length	Width	Height
3.35" 85 mm	1.69" 43.5 mm	0.52" 13.2 mm

# Components

SKU	Model	Details	Color	Strip Quantity	Box Quantity
93128533	GEDS71-3	Tetra Snap DS 7100K	White	32 modules per strip. 1 strip/bag	7 bags (224 modules) per box
93128534	GEDS65-3	Tetra Snap DS 6500K	Warm White	32 modules per strip. 1 strip/bag	7 bags (224 modules) per box
93128535	GEDS57-3	Tetra Snap DS 5700K	Warm White	32 modules per strip. 1 strip/bag	7 bags (224 modules) per box
93128546	GEDS50-3	Tetra Snap DS 5000K	Warm White	32 modules per strip. 1 strip/bag	7 bags (224 modules) per box
93128547	GEDS41-3	Tetra Snap DS 4100K	Warm White	32 modules per strip. 1 strip/bag	7 bags (224 modules) per box
93128548	GEDS32-3	Tetra Snap DS 3200K	Warm White	32 modules per strip. 1 strip/bag	7 bags (224 modules) per box

## Technical Specifications

Model	CCT	Typical Brightness Lumens/module	Typical Brightness Lumens/m	Voltage	Leds/Module	Energy Consumption Module/system (W)	Power Supply Loading	Viewing Angle
Tetra Snap DS	7100K, 6500K, 5700K, 5000K, 4100K	400	Regular output: 1968.5 High output: 750 Ludicrous mode: 1000	24V	8	2.6/3.1	GLX: 32 modules / 100W PS	170°
	3200K	360	Regular output: 1771.7 High output: 675 Ludicrous mode: 900				GLX2/TT: 33 modules / 100W PS	

## Additional Specifications

<b>Dimmable</b>	Yes (with dimmable power supply)				
<b>Cutting Resolution</b>	Cut on wire between every module				
<b>Module Spacing</b>	1.4 modules/foot				
<b>Extrusion Spacing</b>	Regular output: 1.5 modules/foot High output: 1.9 modules/foot Ludicrous mode: 2.5 modules/foot				
<b>Power Supply</b>	Tetra 24V DC				
<b>Maximum Supply Wire Limits</b>		<b>18 AWG/0.82 mm<sup>2</sup> Supply Wire</b>	<b>16 AWG/1.31 mm<sup>2</sup> Supply Wire</b>	<b>14 AWG/2.08 mm<sup>2</sup> Supply Wire</b>	<b>12 AWG/3.31 mm<sup>2</sup> Supply Wire</b>
	25W Power Supply	120 ft./36.6 m	/	/	/
	80W Power Supply	20 ft./6.1 m	25 ft./7.6 m	35 ft./10.6 m	40 ft./12.1 m
	100W Power Supply	20 ft./6.1 m	25 ft./7.6 m	35 ft./10.6 m	40 ft./12.1 m
	200W Power Supply	20 ft./6.1 m	25 ft./7.6 m	35 ft./10.6 m	40 ft./12.1 m
300W Power Supply	20 ft./6.1 m	25 ft./7.6 m	35 ft./10.6 m	40 ft./12.1 m	
<b>Operating Environment</b>	-40 °C to +60 °C (-40 °F to +140 °F)				
<b>Module Dimensions (L x W x H)</b>	3.35" x 1.69" x 0.52" (85 mm x 42.5 mm x 13.2 mm)				
<b>Warranty</b>	Limited system warranty of up to ten (10) years				
<b>System Certifications</b>	UL Recognized (c-us), UL Classified (c-us), CE, ROHS, IP66, UL Damp Rated				





# Tetra<sup>®</sup> Snap SS

CABINET AND CHANNEL LETTER SIGN LIGHTING SYSTEMS

For those who don't have  
time to screw around

**Tetra<sup>®</sup>Snap SS** — your shop's new MVP. Our most flexible product ever, Snap SS is a single-sided module that not only clips onto a screwless aluminum extrusion, allowing module spacing and brightness levels to be customized on-the-fly, but can also be used in large channel letters. Meet the product that replaces sticks and modules alike. Meet **Tetra<sup>®</sup>Snap SS**.

## Oh snap!

Tetra® Snap SS modules pump out 200 lumens each, and can either be installed at three different spacings on our rail, for a maximum 500 lumens per foot, or in large channel letters. Beat that.

## Load 'em up

Load 66 Tetra® Snap modules per 100W power supply, enough to light a single 163 x 406 cm sign.

## Your shop's MVP

With the flexibility to be placed closer to the sign face, Tetra Snap SS can be used in your deepest, most challenging cabinets. It can also be used in channel letters up to 30.5 cm deep.

You may be wondering what the catch is. But it only gets better. Here's how to install Snap:

- Step 1: Snap modules into extrusion.
- Step 2: Install extrusion into sign.
- Step 3: Plug in. Enjoy results.

No catch. **Tetra® Snap.**



## Tetra® Snap SS Features

- Wide 170° beam angle
- Efficacy: Up to 153 lm/W
- 24 Volt DC, Class 2 (UL), Class III (IEC)
- UL Wet Rated & IP66
- 10-year limited warranty

## Spacing Guidelines

	Depth	Max stroke
Double sided	5" (127 mm)	13" (330 mm)
	6" (152 mm)	16" (406 mm)
	7" (178 mm)	18" (457 mm)
	8" (203 mm)	20" (508 mm)

## Module Dimensions

Length	Width	Height
3.35" (85 mm)	1.69" (43 mm)	0.52" (13 mm)

# Brightness Chart

Our Brightness Chart provides a clear explanation of the light levels you can achieve using the same Tetra Snap modules and rail, as well as your customer's predicted\* happiness levels.

\* Happiness levels estimated by our proprietary artificial intelligence algorithm  
 † Marketing manager

Brightness level	Lumens per foot	Your inventory level	Your customer's happiness
Regular output	600	Low	☺
High output	750	Still low	☺ ☺
Ludicrous mode	1000	Yup, still low	☺ ☺ ☺

# Mechanical Outline

Dimensions in (inches). Metric equivalent mmm

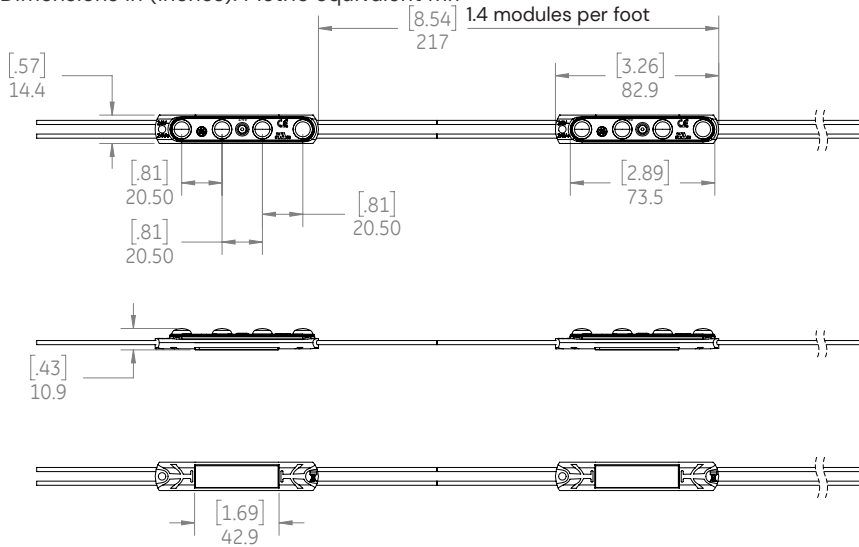

# Viewing Angle

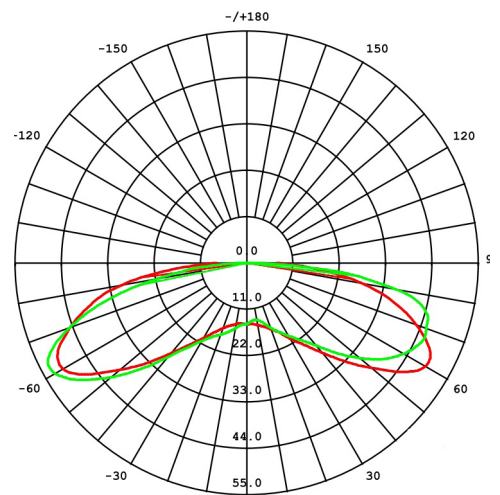

# Accessories

SKU	Model number	Description	Package Quantity
93136587	GESSPC-3	Plastic clip for single-sided Snap module	256
93136588	GESSMC-3	Metal clip for single-sided Snap module	256
93130907	GEDSIC-3	Interconnector (to join two sections of rail)	20
93130908	GEDSTC-3	T-connector (to install perpendicular rails in a grid pattern)	20
93130909	GEDSFE-3	Frame endcap (for mounting directly to sign structures)	40
93130910	GEDSSE-3	Socket endcap (for mounting in existing sockets)	40
93138680	GESSDR-3	Dual rail socket endcap	40
93128550	GEDSRL08-3	2.4 m rail	20

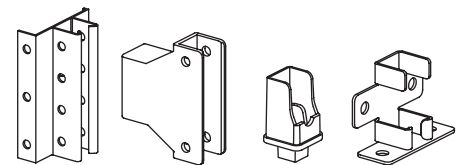

GEDSIC-3 GEDSTC-3 GEDSSE-3 GEDSFE-3

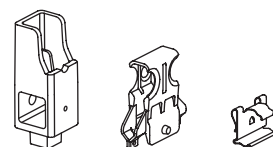

GESSDR-3 GESSPC-3 GESSMC-3

# Components

SKU	Model	Details	Color	Order unit	Strip Quantity	Box Quantity
93136551	GEPMH2471-WIX	Tetra® Snap SS 24V 7100K	White	Box	64 modules per strip, 1 strip/ bag	4 bags (256 modules) per box
93136552	GEPMH2465-WIX	Tetra® Snap SS 24V 6500K	Warm White	Box	64 modules per strip, 1 strip/ bag	4 bags (256 modules) per box
93136553	GEPMH2457-WIX	Tetra® Snap SS 24V 5700K	Warm White	Box	64 modules per strip, 1 strip/ bag	4 bags (256 modules) per box
93136554	GEPMH2450-WIX	Tetra® Snap SS 24V 5000K	Warm White	Box	64 modules per strip, 1 strip/ bag	4 bags (256 modules) per box
93136555	GEPMH2441-WIX	Tetra® Snap SS 24V 4100K	Warm White	Box	64 modules per strip, 1 strip/ bag	4 bags (256 modules) per box
93136586	GEPMH2432-WIX	Tetra® Snap SS 24V 3200K	Warm White	Box	64 modules per strip, 1 strip/ bag	4 bags (256 modules) per box

## Technical Specifications

Model	Wavelength/CCT	Typical Brightness Lumens/module	Typical Module Brightness (No Rail) (Lumens/foot)	Typical Brightness Lumens/foot	Voltage	Leds/Module	Energy Consumption Module/system (W)	Power Supply Loading	Viewing Angle
Tetra Snap SS	7100K, 6500K, 5700K, 5000K, 4100K	200	280	Regular output: 300 High output: 375 Ludicrous mode: 500	24V	4	1.3/1.9	GLX: 64 modules / 100W PS	170°
	3200K	180	252	Regular output: 270 High output: 338 Ludicrous mode: 450				GLX2/TT: 66 modules / 100W PS	

## Additional Specifications

<b>Dimmable</b>	Yes (with dimmable power supply)				
<b>Cutting Resolution</b>	Cut on wire between every module				
<b>Module Spacing</b>	1.4 modules/foot				
<b>Extrusion Spacing</b>	Regular output: 1.5 modules/foot High output: 1.9 modules/foot Ludicrous mode: 2.5 modules/foot				
<b>Power Supply</b>	Tetra 24V DC				
<b>Maximum Supply Wire Limits</b>		<b>18 AWG/0.82 mm<sup>2</sup> Supply Wire</b>	<b>16 AWG/1.31 mm<sup>2</sup> Supply Wire</b>	<b>14 AWG/2.08 mm<sup>2</sup> Supply Wire</b>	<b>12 AWG/3.31 mm<sup>2</sup> Supply Wire</b>
	25W Power Supply	120 ft./36.6 m	/	/	/
	80W Power Supply	20 ft./6.1 m	25 ft./7.6 m	35 ft./10.6 m	40 ft./12.1 m
	100W Power Supply	20 ft./6.1 m	25 ft./7.6 m	35 ft./10.6 m	40 ft./12.1 m
	200W Power Supply	20 ft./6.1 m	25 ft./7.6 m	35 ft./10.6 m	40 ft./12.1 m
300W Power Supply	20 ft./6.1 m	25 ft./7.6 m	35 ft./10.6 m	40 ft./12.1 m	
<b>Operating Environment</b>	-40 °C to +60 °C (-40 °F to +140 °F)				
<b>Module Dimensions (L x W x H)</b>	3.26 in x 0.57 in x 0.42 in (82.9 mm x 14.4 mm x 10.76 mm)				
<b>Warranty</b>	Limited system warranty of up to ten (10) years				
<b>System Certifications</b>	UL Recognized (c-us), UL Classified (c-us), CE, ROHS, IP66, UL Wet Rated				





# Tetra<sup>®</sup> EdgeStrip

CABINET SIGN LIGHTING SYSTEMS

The cutting edge of uniform brightness.

Tetra<sup>®</sup> EdgeStrip is engineered to install easily around the edge of signs with a 3 to 6 inch can depth. Perfect for single or double-sided signs, Tetra<sup>®</sup> EdgeStrip delivers money-saving advantages over T8 fluorescent tubes while producing outstanding visual performance that protects end-user brand image. Discover the new LED alternative that can handle shallow cabinet signs – Tetra<sup>®</sup> EdgeStrip.

## Improved brightness

Tetra® EdgeStrip is now brighter than the previous generation, commanding attention to your customer's brand image. 300 lumens per foot with the same loading : 36 modules per 24V 100W power supply

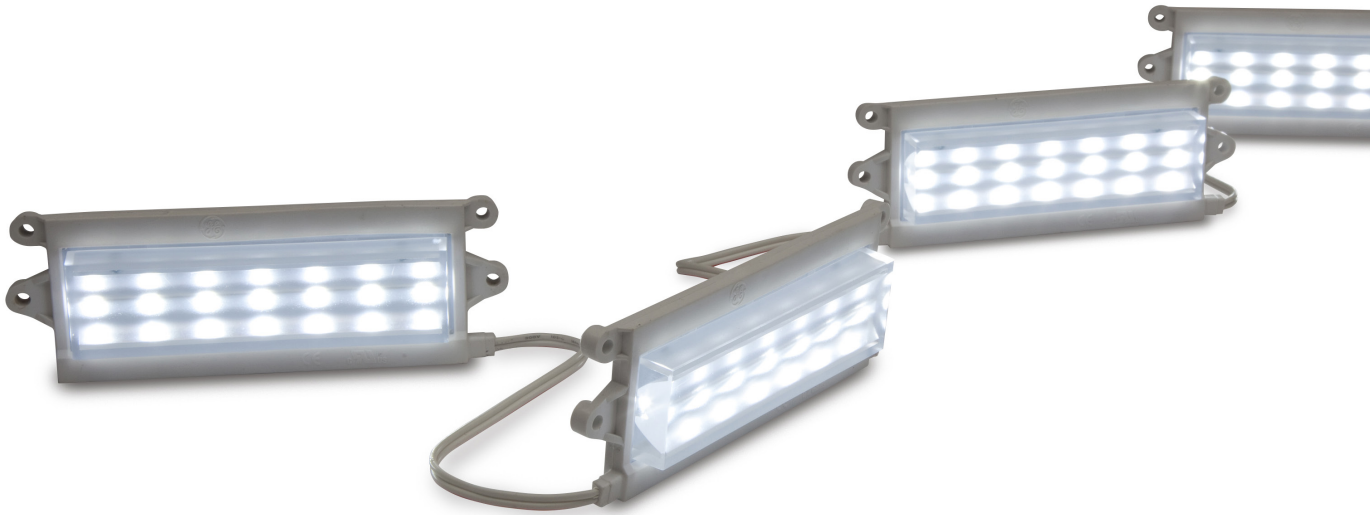

## The OptiLens™ Difference.

Tetra® EdgeStrip uses OptiLens™, our unique lens technology which captures otherwise wasted light and redirects it towards the illuminated surface to create an exceptionally uniform sign.

T8 fluorescent tubes can create an unwanted striping effect where the space between the tubes appears darker. This visual distraction sends the wrong message about your business, and undermines your overall brand image.



Fluorescent T8  
Shadows and Striping

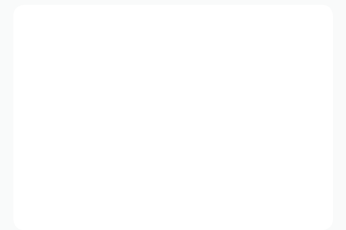

Tetra®EdgeStrip  
Even Illumination

## Cover any angle or curved shape with uniform LED light.

Tetra® EdgeStrip is designed to fit into the frame of cabinet signs, meaning that curved, angular or custom shaped signs can now benefit from LED technology! Unlike fluorescent tubes, that are hard to fit into unique signs and create shadows and stripping, Tetra® EdgeStrip can tightly follow the contour of the sign's frame and distribute uniform light to every inch of the sign face. Protect the brand image of your business by using Tetra® EdgeStrip LED lighting system in your sign.



## Impressive Energy Savings.

When you make the switch from T8 Fluorescent tubes to the advanced technology of Tetra EdgeStrip, you give up some brightness for the exceptional uniformity and impressive energy savings of LED. This superior efficiency produces energy savings up to an incredible 78%. Imagine the positive impact that will have on your bottom-line over the long life of the system.

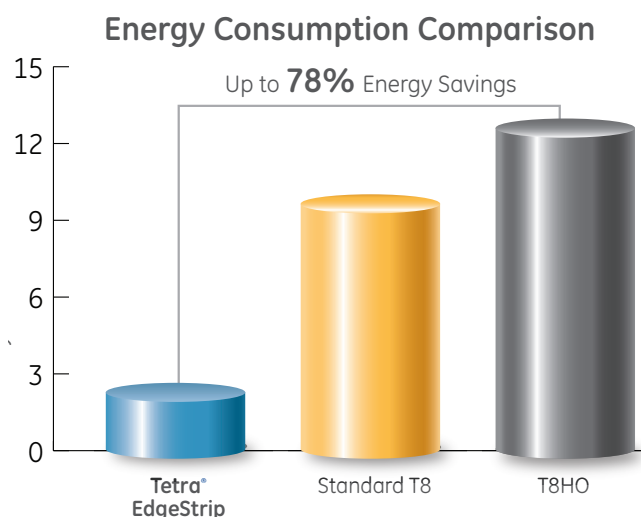

## Tetra® EdgeStrip Features

HO ONLY: NEW heat sink to manage thermals.

OptiLens™ maximizes the area of light coverage by creating a narrow, uniform viewing angle.

Brighter than ever before.

Robust design to protect against moisture, dust and damage.

3M VHB™ industrial grade mounting tape allows for greater convenience when installing.

Continuous wire through LED module uses IDC connectors for maximum strain relief.

Can be cut on wires between modules.

Pre-drilled holes makes mounting easy.

Overmolded design protects against moisture, dust and damage.

10-year limited warranty

# Components

SKU	Description	Package quantity
GEBI71-2	Tetra EdgeStrip 7100K	32 Modules
GEBI50-2	Tetra EdgeStrip 5000K	32 Modules
GEBI41-2	Tetra EdgeStrip 4100K	32 Modules
GEBI32-2	Tetra EdgeStrip 3200K	32 Modules
GEBIH71-2	Tetra EdgeStrip High Output 7100K	32 Modules
GEBIH50-2	Tetra EdgeStrip High Output 5000K	32 Modules
GEBIH41-2	Tetra EdgeStrip High Output 4100K	32 Modules
GEBIH32-2	Tetra EdgeStrip High Output 3200K	32 Modules
9409	18 AWG Supply Wire (0.82 mm <sup>2</sup> )	500 ft./spool (152.4 m)
191600041	22-14 AWG Twist-On Wire Connectors (0.33 – 2.08 mm <sup>2</sup> )	500/PK
192160004	18-14 AWG In-line Connectors (IDC) (0.82 – 2.08 mm <sup>2</sup> )	500/PK

## Technical Specifications

Product	Wavelength/CCT	Typical Brightness Lumens/module	LEDs per Module	Energy Consumption Module Wattage	Energy Consumption System Wattage	100W Power Supply Loading	Viewing Angle
Tetra EdgeStrip	"7100K, 5000K 4100K, 3200K"	"300 282"	7	2.52w/module	2.96w/module	36 Modules	27 x 80°
"Tetra Edgestrip High Output"	"7100K, 5000K 4100K, 3200K"	"550 500"	7	5.40w/module	6.17w/module	17 Modules	27 x 80°

## Additional Specifications

<b>Dimmable</b>	Yes (with dimmable power supply)		
<b>Cutting Resolution</b>	Cut on wire between every module		
<b>Power Supply</b>	GEPS24-25-NA Input: 100-305VAC; Output: 24VDC GEPS24D-80U Input: 90-305VAC; Output: 24VDC GEPS24-100U Input: 108-305VAC; Output: 24VDC GEPS24-200U Input: 90-305VAC; Output: 24VDC GEPS24-300U Input: 108-305VAC; Output: 24VDC		
<b>Maximum Supply Wire Limits</b>	<b>80W, 100W, 200W, 300W</b>	<b>20W</b>	<b>Supply Wire Gauge</b>
	20 ft. (6.1 m)	120 ft. (36.6 m)	18AWG/0.82mm <sup>2</sup> supply wire – 9409
	25 ft. (7.6 m)		16AWG/1.31mm <sup>2</sup> supply wire
	35 ft. (10.6 m)		14AWG/2.08mm <sup>2</sup> supply wire
	40 ft. (12.1 m)		12AWG/3.31mm <sup>2</sup> supply wire
	Wiring to be installed in accordance with Article 725 of the National Electric code (NEC).		
<b>Operating Environment</b>	-40 °C to +60 °C (-40 °F to +140 °F)		
<b>Module Dimensions (h x l x w)</b>	Tetra EdgeStrip: 0.59" x 1.98" x 5.45" (14.98 x 50.29 x 138.43 mm)		Tetra EdgeStrip HO: 0.76 x 1.98 x 5.45 (19.30 x 50.29 x 138.43 mm)
<b>Sign Dimensions</b>	For best results, recommended sign depth is 3 inches (76 mm) or greater		For best results, recommended sign depth is 5 inches (127 mm) or greater
<b>Warranty</b>	Limited system warranty of up to ten (10) years		
<b>System Certifications</b>	UL Recognized #E219167, UL Classified #E229508, CE, C-tick IP66 rated: separate enclosure required, damp location rated		





# Tetra<sup>®</sup> Slim EdgeStrip

CABINET SIGN LIGHTING SYSTEMS

The cutting edge of uniform brightness.

Tetra<sup>®</sup> Slim EdgeStrip is engineered to install easily around the edge of shallow to medium depth signs—as low as 50mm deep. Ideal for single or double-sided signs, as well as acrylic or fabric faces, Tetra<sup>®</sup> Slim EdgeStrip delivers money-saving advantages over competitive LED solutions, while producing outstanding visual performance that enhances end-user brand image.

## Brighter Than Ever

Tetra® Slim EdgeStrip pumps out a maximum 235 lumens per module, and our focused optic throws the light where it matters, showing your brand in its best light.

## Increased Loading

Load up to 57 modules per 24V 100W power supply. Tetra® Slim EdgeStrip uses only 1.44 Watts per module, for an efficacy of 109 lumens per Watt thanks to our 24V platform.

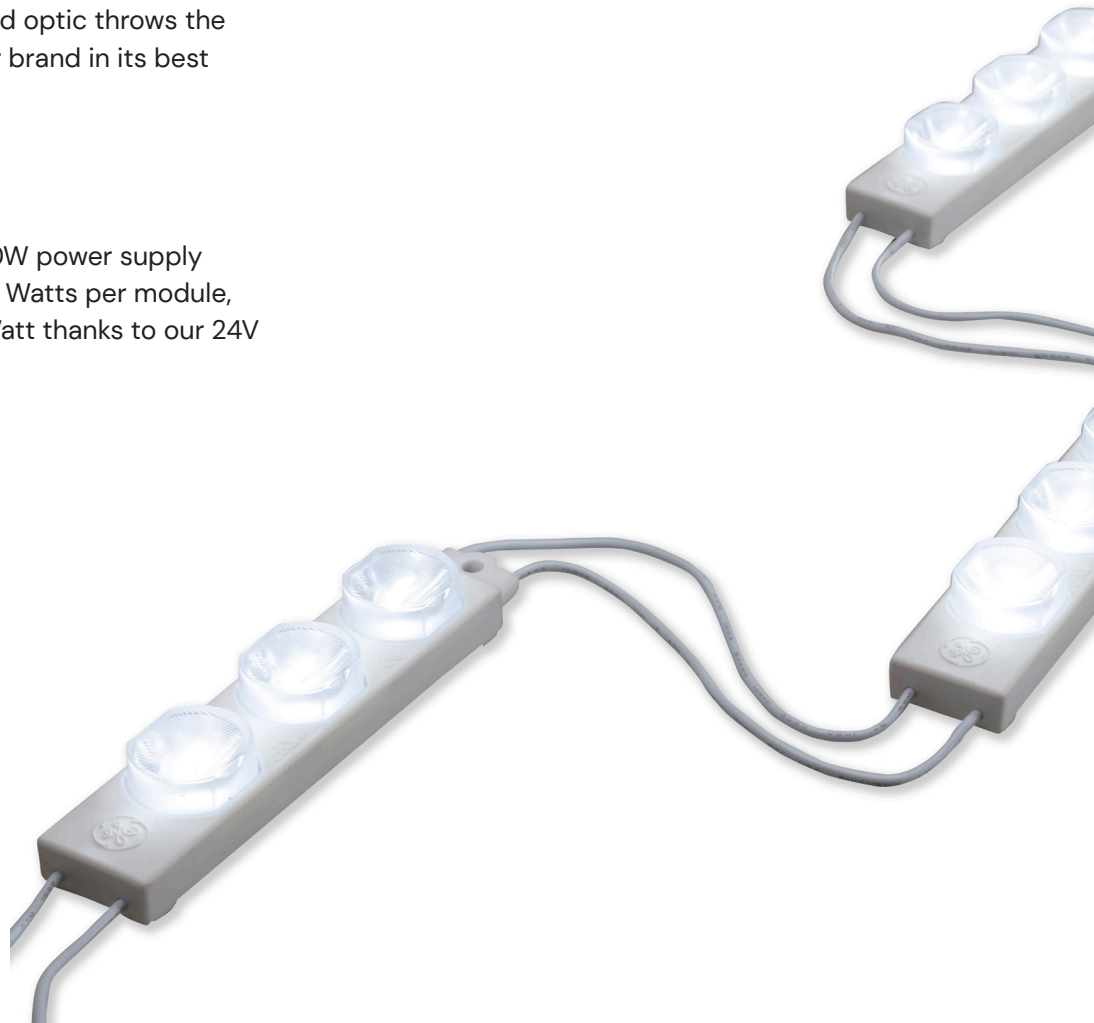

## Tetra® Slim EdgeStrip Features

- Targeted 15°x35° beam angle
- Improved luminous intensity
- Efficacy: 97-109 lm/W
- 24 Volt DC, Class 2 (UL), Class III (IEC)
- UL Damp Rated & IP66
- 10-year limited warranty

## Module Dimensions

Length	Width	Height
3.76" / 96mm	0.79" / 20mm	0.56" / 14mm

## Tetra® Slim EdgeStrip Spacing

Modules/ft	Can Depth	Coverage (1 side)	Coverage (2 sides)
2.5 (8.2 m)	2" (51 mm)	2 ft (609 mm)	4 ft (1219 mm)
2 (6.6 m)	3" (76 mm)	2 ft (609 mm)	4 ft (1219 mm)
	≥ 4" (102 mm)		

## Cover any angle or curved shape with uniform LED light.

Tetra® Slim EdgeStrip's low-profile is designed to fit into the frame of shallow cabinet signs, meaning that curved, angular or custom shaped signs can now benefit from LED technology! Unlike fluorescent tubes, that are hard to fit into unique signs and create shadows and striping, Tetra® Slim EdgeStrip can tightly follow the contour of the sign's frame and distribute uniform light to every inch of the sign face. Protect the brand image of your business by using Tetra® Slim EdgeStrip LED lighting system in your sign.

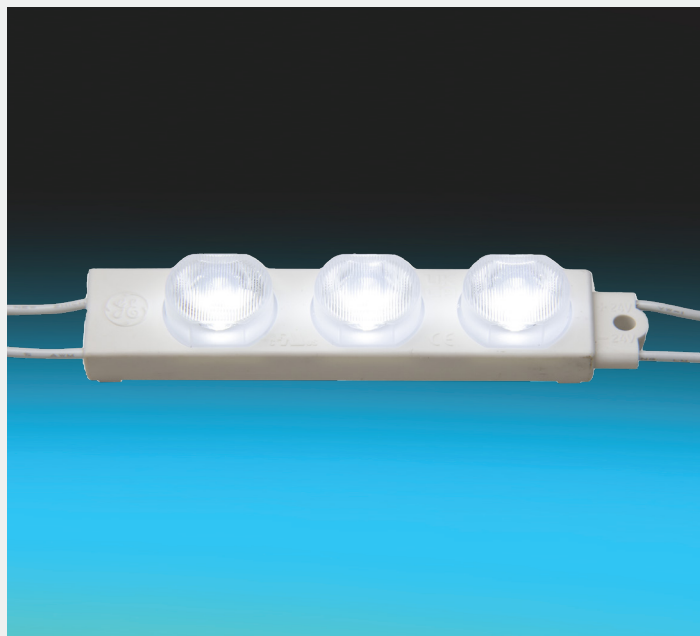

## Mechanical Outline

Dimensions in mm. Metric equivalent in (inches)

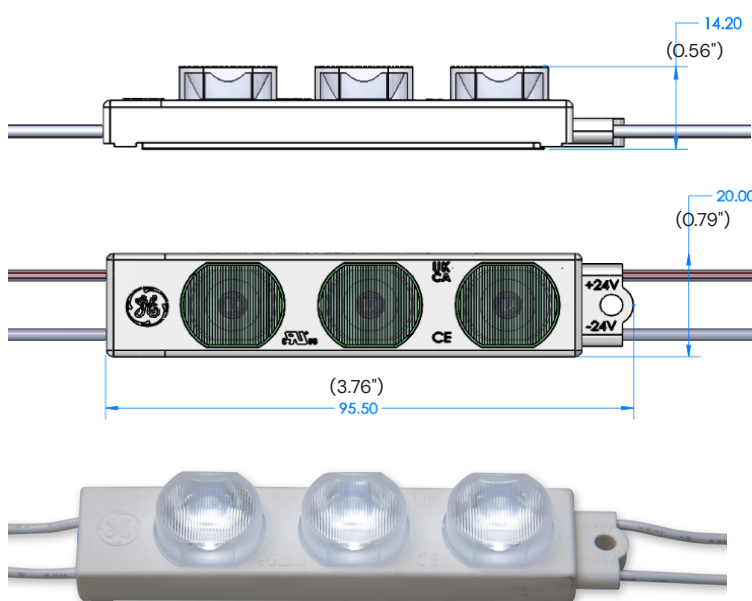

## Viewing Angle

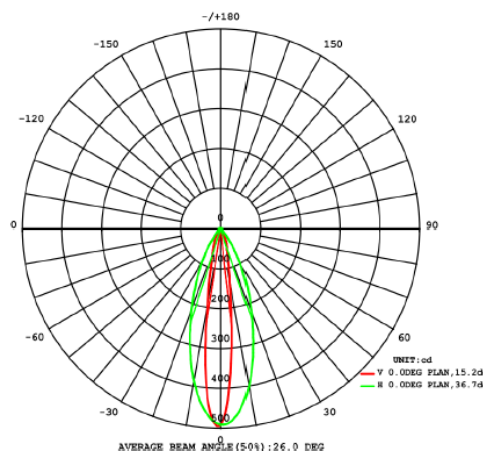

## Tetra® EdgeStrip Features

Optical design maximizes the area of light coverage by creating a narrow, uniform viewing angle

3M VHB™ industrial grade mounting tape allows for greater convenience when installing

Continuous wire through LED module uses IDC connectors for maximum strain relief

Robust, overmolded design protects against moisture, dust and damage

Can be cut on wires between modules

Pre-drilled holes make mounting easy

10-year limited warranty

# Components

SKU	Order Code	Description	Color	Strip Quantity	Box Quantity
93145540	GEBI71-S2	Tetra Slim EdgeStrip 7100K	White	30 modules per strip, 1 strip per bag	5 bags (150 modules) per box
93145561	GEBI65-S2	Tetra Slim EdgeStrip 6500K	Warm White	30 modules per strip, 1 strip per bag	5 bags (150 modules) per box
93145563	GEBI50-S2	Tetra Slim EdgeStrip 5000K	Warm White	30 modules per strip, 1 strip per bag	5 bags (150 modules) per box
93145564	GEBI41-S2	Tetra Slim EdgeStrip 4100K	Warm White	30 modules per strip, 1 strip per bag	5 bags (150 modules) per box
93145565	GEBI32-S2	Tetra Slim EdgeStrip 3200K	Warm White	30 modules per strip, 1 strip per bag	5 bags (150 modules) per box
93145534	GEBIH71-S2	Tetra Slim EdgeStrip HO 7100K	White	30 modules per strip, 1 strip per bag	5 bags (150 modules) per box
93145535	GEBIH65-S2	Tetra Slim EdgeStrip HO 6500K	Warm White	30 modules per strip, 1 strip per bag	5 bags (150 modules) per box
93145537	GEBIH50-S2	Tetra Slim EdgeStrip HO 5000K	Warm White	30 modules per strip, 1 strip per bag	5 bags (150 modules) per box
93145538	GEBIH41-S2	Tetra Slim EdgeStrip HO 4100K	Warm White	30 modules per strip, 1 strip per bag	5 bags (150 modules) per box
93145539	GEBIH32-S2	Tetra Slim EdgeStrip HO 3200K	Warm White	30 modules per strip, 1 strip per bag	5 bags (150 modules) per box

\*Other CCTs are available on a special order basis. Please reach out to your Current sales manager for details.

## Technical Specifications

Product	CCT	Typical Brightness* Lumens/module	LEDs/ Module	Energy Consumption* Module Wattage	Energy Consumption* System Wattage	100W GLX Power Supply Loading**	Viewing Angle
Tetra Slim EdgeStrip	7100K, 6500K, 5000K, 4100K	157	3	1.44W/module	1.69W/module	57 Modules (11.4 m)	15° x 35°
Tetra Slim EdgeStrip	3200K	140	3	1.44W/module	1.69W/module	57 Modules (11.4 m)	15° x 35°
Tetra Slim EdgeStrip High Output	7100K, 6500K, 5000K, 4100K	235	3	2.16W/module	2.54W/module	38 Modules (7.6 m)	15° x 35°
Tetra Slim EdgeStrip High Output	3200K	210	3	2.16W/module	2.54W/module	38 Modules (7.6 m)	15° x 35°

\*Typical performance at 25C +/- 10%

## Additional Specifications

Specification Item	Specification				
<b>Voltage</b>	24VDC				
<b>Dimmable</b>	Yes (with dimmable power supply)				
<b>Cutting Resolution</b>	Cut on wire between every module				
<b>Power Supply</b>	GEPS24-25U Input: 100-305VAC; Output: 24VDC GEPS24-100U Input: 108-305VAC; Output: 24VDC GEPS24-150U Input: 176-305VAC; Output: 24VDC GEPS24-200U Input: 90-305VAC; Output: 24VDC GEPS24-300U Input: 108-305VAC; Output: 24VDC				
<b>Maximum Remote Mounting Distance</b>					
	25W Power Supply	18 AWG/0.82 mm <sup>2</sup> Supply Wire	16 AWG/1.31 mm <sup>2</sup> Supply Wire	14 AWG/2.08 mm <sup>2</sup> Supply Wire	12 AWG/3.31 mm <sup>2</sup> Supply Wire
	100W Power Supply	120 ft./36.6 m	-	-	-
	150W Power Supply	20 ft./6.1 m	25 ft./7.6 m	35 ft./10.6 m	40 ft./12.1 m
	200W Power Supply	20 ft./6.1 m	25 ft./7.6 m	35 ft./10.6 m	40 ft./12.1 m
	300W Power Supply	20 ft./6.1 m	25 ft./7.6 m	35 ft./10.6 m	40 ft./12.1 m
	Wiring to be installed in accordance with Article 725 of the National Electric Code (NEC).				
<b>Operating Environment</b>	-40 °C to +60 °C (-40 °F to +140 °F)				
<b>Dimensions (L x W x H)</b>	3.76"x0.79"x0.56" (95.5 x 20 x 14.2 mm)				
<b>Warranty</b>	Current offers a limited system warranty of up to ten (10) years				
<b>System Certifications</b>	UL Recognized #E219167, UL Classified #E229508, CE, UKCA, IP66 rated: separate enclosure required, damp location rated				





# Tetra<sup>®</sup> Contour Flex

BORDER LIGHTING LIGHTING SYSTEMS

## Bend it Like Contour

Tetra<sup>®</sup> Contour Flex is a completely flexible LED neon replacement that can be shaped over and over again, with no heating required. Contour Flex installation is quick and easy using low-profile mounting clips. It provides a bright, uniform appearance, seamless illumination and allows signmakers' creativity to run wild. Tetra<sup>®</sup> Contour Flex can be custom cut in the field without complicated warranty implications, and features a plug & play design that saves on labor and installation costs.

## Flexible neon replacement system

Tetra® Contour Flex is a flexible LED system that can be easily formed to fit a wide variety of designs and applications, without the need to heat it in an oven. Tetra® Contour Flex can be custom cut in the field and bent over and over again, allowing sign makers to create vibrant signs. Tetra Contour Flex is a single-piece LED system that provides the classic appearance of neon and complements the unique design of any building.

## Range of Colors

With two shades of white and several brilliant LED colors, designers have more flexibility than ever to easily create custom signs.

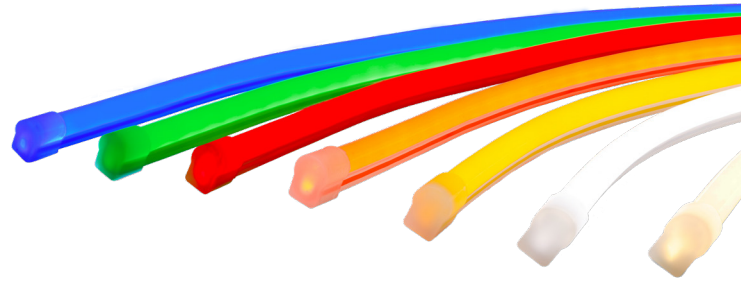

## Straight Runs

With the available Tetra Contour Flex Rail, simply insert Contour Flex into the U-channel to create perfectly linear runs.

## Mechanical Outline

Dimensions in (inches). Metric equivalent mm

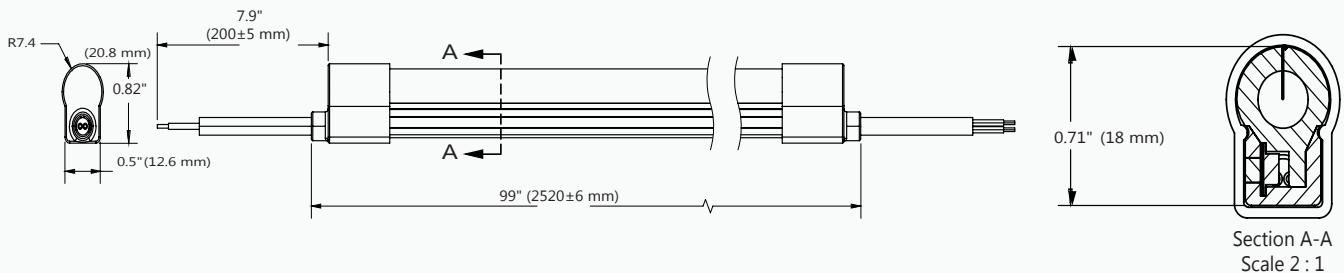

## Accessories Outline

Dimensions in inches. Metric equivalent (mm).

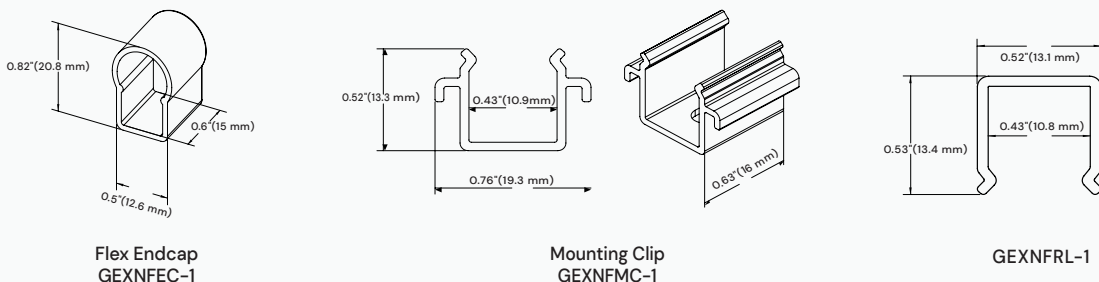

## Vastly Superior Loading

Compared to the first generation, Tetra® Contour Flex features loading increased by up to 114%, so even more feet of product can be run off each power supply than ever before providing significant savings on material and labor costs.

## Durable Robust System

Designed using Six Sigma quality standards, the Tetra® Contour Flex LED lighting system has a long life that delivers up to five years of continuous 24/7 use. Impact resistant design helps eliminate excess shipping, installation and maintenance costs due to breakage. It withstands harsh weather conditions, vibration and stress, and is backed by our 5-year limited warranty.

## Technical Specifications

Specification Item	Wavelength Color Temp	Typical Brightness* lumens/ft (lumens/m) (light engine)	LEDs per Module	Energy Consumption* Strip/ft (Strip/m)	Energy Consumption* System/ft (System/m)	Power Supply Loading GLX2** ft/100W (m/100W)	Viewing Angle
GEXNFS32-1	3200K	65 (213)	21	1.4W/ft (4.6 W)	1.6W/ft (5.2 W)	62 (19)	115°/330°
GEXNFS65-1	6500K	78 (256)	21	1.4W/ft (4.6 W)	1.6W/ft (5.2 W)	62 (19)	115°/330°
GEXNFSRD-1	625nm	21 (69)	21	1.4W/ft (4.6 W)	1.6W/ft (5.2 W)	62 (19)	115°/330°
GEXNFSGL-1	532nm	40 (131)	21	1.4W/ft (4.6 W)	1.6W/ft (5.2 W)	62 (19)	115°/330°
GEXNFSBL-1	467nm	7 (23)	21	1.4W/ft (4.6 W)	1.6W/ft (5.2 W)	62 (19)	115°/330°
GEXNFSYG-1	589nm	15 (49)	21	1.4W/ft (4.6 W)	1.6W/ft (5.2 W)	62 (19)	115°/330°
GEXNFSRC-1	618nm	30 (98)	21	1.4W/ft (4.6 W)	1.6W/ft (5.2 W)	62 (19)	115°/330°

\*Typical performance at 25C +/- 10%

\*\*GEPS24-100U-GLX2 or GEPS24-100U-TT

<b>Voltage</b>	24VDC				
<b>Cutting Resolution</b>	On Contour <b>ONLY</b> cut on wire between every module or the location showing "CUT HERE ONLY" on module.				
<b>Dimmable</b>	Yes (with dimmable power supply)				
<b>Power Supply</b>	GEPS24-25U Input: 100-305VAC; Output: 24VDC GEPS24D-60U Input: 120-277VAC; Output: 24VDC GEPS24-100U Input: 108-305VAC; Output: 24VDC GEPS24-200U Input: 90-305VAC; Output: 24VDC GEPS24-300U Input: 108-305VAC; Output: 24VDC				
<b>Maximum Supply Wire Limits</b>		<b>18 AWG/0.82 mm<sup>2</sup> Supply Wire</b>	<b>16 AWG/1.31 mm<sup>2</sup> Supply Wire</b>	<b>14 AWG/2.08 mm<sup>2</sup> Supply Wire</b>	<b>12 AWG/3.31 mm<sup>2</sup> Supply Wire</b>
	25W Power Supply	120 ft./36.6 m	-	-	-
	60W Power Supply	20 ft./6.1 m	25 ft./7.6 m	35 ft./10.6 m	40 ft./12.1 m
	100W Power Supply	20 ft./6.1 m	25 ft./7.6 m	35 ft./10.6 m	40 ft./12.1 m
	200W Power Supply	20 ft./6.1 m	25 ft./7.6 m	35 ft./10.6 m	40 ft./12.1 m
300W Power Supply	20 ft./6.1 m	25 ft./7.6 m	35 ft./10.6 m	40 ft./12.1 m	
<b>Operating Environment</b>	-40 °C to +60 °C (-40 °F to +140 °F)				
<b>Module Dimensions (L x W x H)</b>	0.82 x 0.51 x 99.2" (21 x 13 x 2520 mm)				
<b>Warranty</b>	Limited system warranty of up to five (5) years				
<b>System Certifications</b>	UL Recognized #E219167, UL Classified #E229508, CE, UKCA, IP66, Acceptable to use in dry, damp, and wet locations.				



# Tetra® Contour Flex Components

SKU	Model	Description	Color	Quantity	Additional Information
93145722	GEXNFS32-1	Tetra® Contour Flex 3200K	Warm White	12/box	Unit Length: 8.4 ft. (2.6m)
93145723	GEXNFS65-1	Tetra® Contour Flex 6500K	White	12/box	Unit Length: 8.4 ft. (2.6m)
93145724	GEXNFSRD-1	Tetra® Contour Flex Red	Red	12/box	Unit Length: 8.4 ft. (2.6m)
93145725	GEXNFSGL-1	Tetra® Contour Flex Green	Green	12/box	Unit Length: 8.4 ft. (2.6m)
93145726	GEXNFSBL-1	Tetra® Contour Flex Blue	Blue	12/box	Unit Length: 8.4 ft. (2.6m)
93145727	GEXNFSYG-1	Tetra® Contour Flex Amber	Amber	12/box	Unit Length: 8.4 ft. (2.6m)
93145728	GEXNFSRC-1	Tetra® Contour Flex Red-Orange	Red-Orange	12/box	Unit Length: 8.4 ft. (2.6m)

## Accessories

	SKU	Description	Color	Quantity	Additional Information
<b>Mounting and Cutting Supplies</b>	93150450	Tetra Contour Flex Endcap GEXNFEC-1		20/box	
	93150511	Tetra Contour Flex Mounting Clip GEXNPMC-1		50/box	
	93150512	Tetra Contour Flex Rail GEXNFR-1		20/box	Tetra Snap rail can also be used
<b>Optional</b>	GEXNWB2	Weather Box	White	20/bag	White, paintable surface
	GEXNLGEC15	Tetra Contour Light Guide End Cap	White	20/bag	
	GEXNLGC15	Tetra Contour Light Guide Connector	White	20/bag	
	GEXNLGI15	Tetra Contour Light Guide 90° Inside Corner	White	20/bag	
	GEXNLGO15	Tetra Contour Light Guide 90° Outside Corner	White	20/bag	
	GEXNLGP15	Tetra Contour Light Guide 90° Planar Corner	White	20/bag	
	GERDXNLGEC15	Tetra Contour Light Guide End Cap	Red	20/bag	
	GERDXNLGC15	Tetra Contour Light Guide Connector	Red	20/bag	
	GERDXNLGI15	Tetra Contour Light Guide 90° Inside Corner	Red	20/bag	
	GERDXNLGO15	Tetra Contour Light Guide 90° Outside Corner	Red	20/bag	
	GERDXNLGP15	Tetra Contour Light Guide 90° Planar Corner	Red	20/bag	
	GEPOXNLGC15	Tetra Contour Light Guide Connector	Orange	20/bag	
	GEPOXNLGEC15	Tetra Contour Light Guide End Cap	Orange	20/bag	
	GEPOXNLGI15	Tetra Contour Light Guide 90° Inside Corner	Orange	20/bag	
	GEPOXNLGO15	Tetra Contour Light Guide 90° Outside Corner	Orange	20/bag	
	GEPOXNLGP15	Tetra Contour Light Guide 90° Planar Corner	Orange	20/bag	
	GEYAXNLGC15	Tetra Contour Light Guide Connector	Yellow	20/bag	
	GEYAXNLGEC15	Tetra Contour Light Guide End Cap	Yellow	20/bag	
	GEYAXNLGI15	Tetra Contour Light Guide 90° Inside Corner	Yellow	20/bag	
	GEYAXNLGO15	Tetra Contour Light Guide 90° Outside Corner	Yellow	20/bag	
	GEYAXNLGP15	Tetra Contour Light Guide 90° Planar Corner	Yellow	20/bag	
	GEGLXNLGEC15	Tetra Contour Light Guide End Cap	Green	20/bag	
	GEGLXNLGC15	Tetra Contour Light Guide Connector	Green	20/bag	
	GEGLXNLGI15	Tetra Contour Light Guide 90° Inside Corner	Green	20/bag	
	GEGLXNLGO15	Tetra Contour Light Guide 90° Outside Corner	Green	20/bag	
	GEGLXNLGP15	Tetra Contour Light Guide 90° Planar Corner	Green	20/bag	
	GEBLXNLGEC15	Tetra Contour Light Guide End Cap Blue	Blue	20/bag	
	GEBLXNLGC15	Tetra Contour Light Guide Connector	Blue	20/bag	
	GEBLXNLGI15	Tetra Contour Light Guide 90° Inside Corner	Blue	20/bag	
	GEBLXNLGO15	Tetra Contour Light Guide 90° Outside Corner	Blue	20/bag	
	GEBLXNLGP15	Tetra Contour Light Guide 90° Planar Corner	Blue	20/bag	



# Tetra<sup>®</sup> Contour Gen 2

BORDER LIGHTING LIGHTING SYSTEMS

## 80% Quicker to Install

Tetra<sup>®</sup> Contour Gen 2 installation is 80% faster compared to the previous generation thanks to the new light engine design. It is also much more uniform in appearance, and still offers seamless illumination and a wide 330° of light output.

Tetra<sup>®</sup> Contour Gen 2 is available in two application-specific versions: Side Bend and Back Bend, which both use the same light guides and accessories.

# Simple neon replacement system

Tetra® Contour Gen 2 is a flexible LED light that can be easily formed to fit a wide variety of designs and applications. Tetra® Contour Gen 2 is available in two models, side-bend and back-bend; and it is the bendable companion product used for creating vibrant border lighting sections. These products comprise a complete LED system that provides the classic appearance of neon and complements the unique design of any building

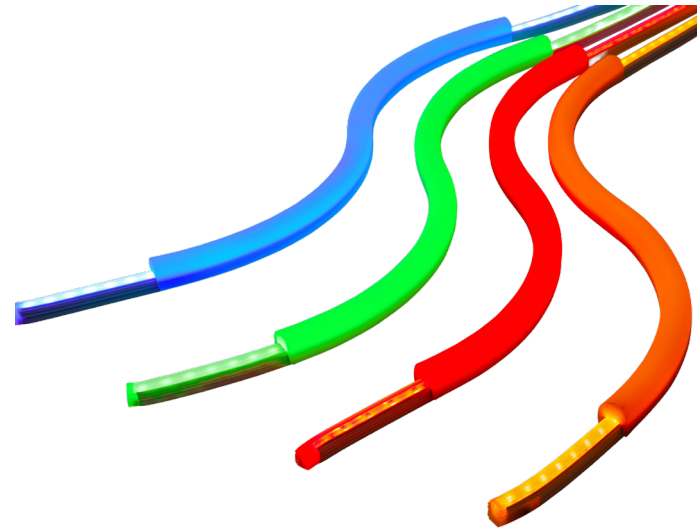

## Range of Colors

With two shades of white and several brilliant LED colors, designers have more flexibility than ever to easily create custom signs.

## Mechanical Outline

Dimensions in (inches). Metric equivalent mm

### Contour Side Bend

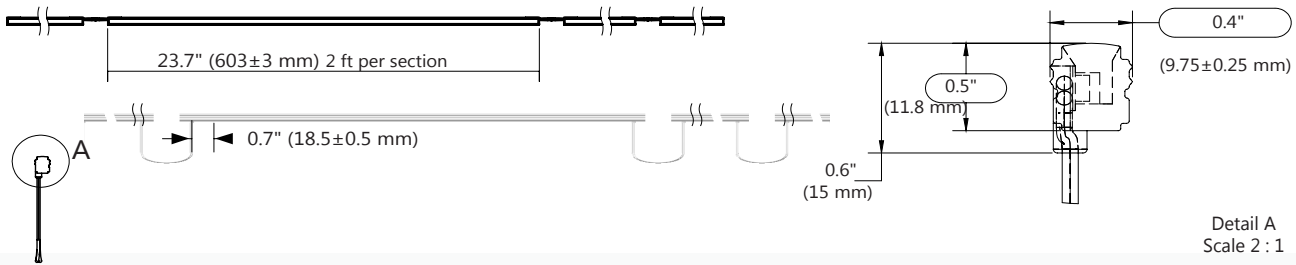

### Contour Back Bend

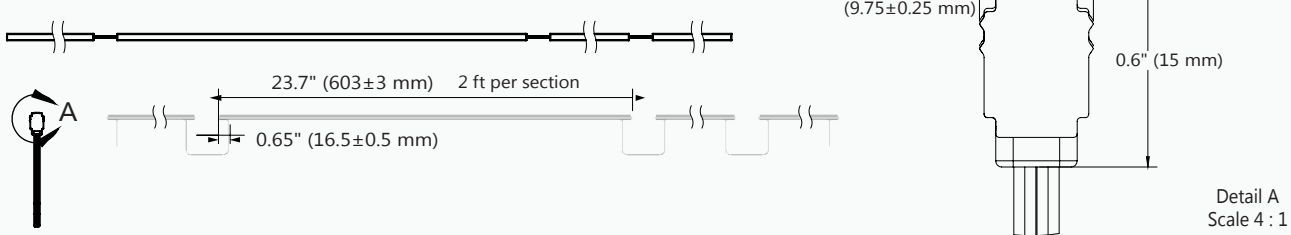

## Accessories Outline

Dimensions in inches. Metric equivalent (mm).

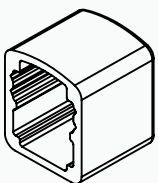

Field Sleeve  
GEXNSL-2

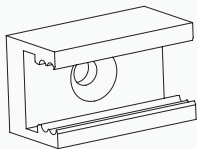

Light Engine Mounting Clip  
GEXNMCAC

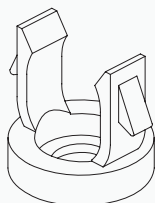

Clear Plastic Light Guide Clip  
GEXNMC15  
(Recommended for Indoor Use)

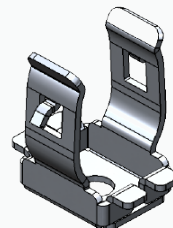

Metal Light Guide Clip  
GEXNMCML-15

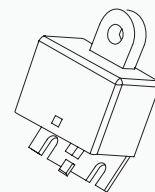

Weather box  
GEXNWB2

# Tetra® Contour Gen 2 – Side Bend and Back Bend

	SKU	Order Code	Description	Color	Quantity	Additional Information
Side Bend	93145688	GEXNS32-2	Tetra® Contour Side Bend 3200K	Warm White	12/Box	Unit Length 8 ft (2.44m)
	93145689	GEXNS65-2	Tetra® Contour Side Bend 6500K	White	12/Box	Unit Length 8 ft (2.44m)
	93145690	GEXNSRD-2	Tetra® Contour Side Bend Red	Red	12/Box	Unit Length 8 ft (2.44m)
	93145711	GEXNSGL-2	Tetra® Contour Side Bend Green	Green	12/Box	Unit Length 8 ft (2.44m)
	93145712	GEXNSBL-2	Tetra® Contour Side Bend Blue	Blue	12/Box	Unit Length 8 ft (2.44m)
	93145713	GEXNSYG-2	Tetra® Contour Side Bend Amber	Amber	12/Box	Unit Length 8 ft (2.44m)
	93145714	GEXNSRC-2	Tetra® Contour Side Bend Red Orange	Red-Orange	12/Box	Unit Length 8 ft (2.44m)
Back Bend	93145715	GEXNB32-2	Tetra® Contour Back Bend 3200K	Warm White	12/box	Unit Length: 8 ft. (2.44m)
	93145716	GEXNB65-2	Tetra® Contour Back Bend 6500K	White	12/box	Unit Length: 8 ft. (2.44m)
	93145717	GEXNBRD-2	Tetra® Contour Back Bend Red	Red	12/box	Unit Length: 8 ft. (2.44m)
	93145718	GEXNBGL-2	Tetra® Contour Back Bend Green	Green	12/box	Unit Length: 8 ft. (2.44m)
	93145719	GEXNBBL-2	Tetra® Contour Back Bend Blue	Blue	12/box	Unit Length: 8 ft. (2.44m)
	93145720	GEXNBYG-2	Tetra® Contour Back Bend Amber	Amber	12/box	Unit Length: 8 ft. (2.44m)
	93145721	GEXNBRC-2	Tetra® Contour Back Bend Red Orange	Red-Orange	12/box	Unit Length: 8 ft. (2.44m)

## Technical Specifications

Order Code	Wavelength Color Temp	Typical Brightness* lumens/ft(light engine)	LEDs per Module	Energy Consumption* (Strip/ft)	Energy Consumption* (System/ft)	Power Supply Loading GLX2** (ft/100W)	Viewing Angle (light engine/ with light guide)
GEXNS32-2	3200K	120 (393)	28	1.9W/ft (6.2W/m)	2.2W/ft (7.2W/m)	46 (14)	115°x330°
GEXNS65-2	6500K	123 (393)	28	1.9W/ft (6.2W/m)	2.2W/ft (7.2W/m)	46 (14)	115°x330°
GEXNSRD-2	625nm	35 (114)	21	1.4W/ft (4.6W/m)	1.6W/ft (5.3W/m)	62 (19)	115°x330°
GEXNSGL-2	532nm	100 (328)	28	1.9W/ft (6.2W/m)	2.2W/ft (7.2W/m)	46 (14)	115°x330°
GEXNSBL-2	467nm	24 (78)	28	1.9W/ft (6.2W/m)	2.2W/ft (7.2W/m)	46 (14)	115°x330°
GEXNSYG-2	589nm	37 (121)	28	1.9W/ft (6.2W/m)	2.2W/ft (7.2W/m)	46 (14)	115°x330°
GEXNSRC-2	618nm	40 (131)	28	1.9W/ft (6.2W/m)	2.2W/ft (7.2W/m)	46 (14)	115°x330°
GEXNB32-2	3200K	120 (393)	28	1.9W/ft (6.2W/m)	2.2W/ft (7.2W/m)	46 (14)	115°x330°
GEXNB65-2	6500K	123 (393)	28	1.9W/ft (6.2W/m)	2.2W/ft (7.2W/m)	46 (14)	115°x330°
GEXNBRD-2	625nm	35 (114)	21	1.4W/ft (4.6W/m)	1.6W/ft (5.3W/m)	62 (19)	115°x330°
GEXNBGL-2	532nm	100 (328)	28	1.9W/ft (6.2W/m)	2.2W/ft (7.2W/m)	46 (14)	115°x330°
GEXNBBL-2	467nm	24 (78)	28	1.9W/ft (6.2W/m)	2.2W/ft (7.2W/m)	46 (14)	115°x330°
GEXNBYG-2	589nm	37 (121)	28	1.9W/ft (6.2W/m)	2.2W/ft (7.2W/m)	46 (14)	115°x330°
GEXNBRC-2	618nm	40 (131)	28	1.9W/ft (6.2W/m)	2.2W/ft (7.2W/m)	46 (14)	115°x330°

\*Typical performance at 25C +/- 10%

\*\*GEPS24-100U-GLX2 or GEPS24-100U-TT

<b>Dimmable</b>	Yes (with dimmable power supply)				
<b>Cutting Resolution</b>	On Contour ONLY cut on wire between every module or the location showing "CUT HERE ONLY" on module.				
<b>Power Supply</b>	GEPS24-25U Input: 100-305VAC; Output: 24VDC GEPS24D-60U Input: 90-305VAC; Output: 24VDC GEPS24-100U Input: 108-305VAC; Output: 24VDC GEPS24-200U Input: 90-305VAC; Output: 24VDC GEPS24-300U Input: 108-305VAC; Output: 24VDC				
<b>Maximum Supply Wire Limits</b>		<b>18 AWG/0.82 mm2 Supply Wire</b>	<b>16 AWG/1.31 mm2 Supply Wire</b>	<b>14 AWG/2.08 mm2 Supply Wire</b>	<b>12 AWG/3.31 mm2 Supply Wire</b>
	25W Power Supply	120 ft./36.6 m	-	-	-
	60W Power Supply	20 ft./6.1 m	25 ft./7.6 m	35 ft./10.6 m	40 ft./12.1 m
	100W Power Supply	20 ft./6.1 m	25 ft./7.6 m	35 ft./10.6 m	40 ft./12.1 m
	200W Power Supply	20 ft./6.1 m	25 ft./7.6 m	35 ft./10.6 m	40 ft./12.1 m
300W Power Supply	20 ft./6.1 m	25 ft./7.6 m	35 ft./10.6 m	40 ft./12.1 m	
<b>Operating Environment</b>	-40 °C to +60 °C (-40 °F to +140 °F)				
<b>Module Dimensions (h x l x w)</b>	Light engine: 0.47" x 15.98" x 0.39" (12 mm x 406 mm x 10.1 mm) Light engine with light guide: 1.10" x 96" x 0.98" (28 mm x 2440 mm x 25 mm)				
<b>Warranty</b>	Limited system warranty of up to five (5) years				
<b>System Certifications</b>	UL Recognized #E219167, UL Classified #E229508, CE, UKCA, IP66, Acceptable to use in dry, damp, and wet locations.				

# Light Guide Components

SKU	Description	Color	Quantity	Additional Information
GERDXNLG15	Tetra® Contour Light Guide	Red	12/box	Unit Length: 8 ft. (2.44m)
GEPOXNLG15	Tetra® Contour Light Guide	Orange	12/box	Unit Length: 8 ft. (2.44m)
GEYAXNLG15	Tetra® Contour Light Guide	Yellow	12/box	Unit Length: 8 ft. (2.44m)
GEGLXNLG15	Tetra® Contour Light Guide	Green	12/box	Unit Length: 8 ft. (2.44m)
GEBLXNLG15	Tetra® Contour Light Guide	Blue	12/box	Unit Length: 8 ft. (2.44m)
GEXNLG15	Tetra® Contour Light Guide	White	12/box	Unit Length: 8 ft. (2.44m)

# Accessories

SKU	Description	Color	Quantity	Additional Information
9409	18 AWG (0.82mm <sup>2</sup> ) Supply Wire		500 ft. (152.40 m) per spool	2 wire
GEXNWB2	Weather Box		20/bag	White, Paintable Surface
GEXNBA	Tetra Contour Silicone Bend-Aid (Reusable)		12/bag	Unit Length: 16 in. (406mm)
GEXNMC15	Tetra Contour Light Guide Clear Mounting Clip		50/bag	
93053776	GEXNMCML-15 – Tetra Contour Light Guide Metal Mounting Clip		50/bag	
GEXNMCAC	Tetra Contour Light Engine Mounting Clip		20/bag	White, Paintable Surface
191600041	22-14 AWG Twist-on Wire Connector (0.82-2.08 mm <sup>2</sup> )		500/bag	
GEXNSL-2	Tetra Contour Light Engine Field Sleeve		20/bag	
GERDXNLGEC15	Tetra Contour Light Guide End Cap	Red	20/bag	
GERDXNLGC15	Tetra Contour Light Guide Connector	Red	20/bag	
GERDXNLGI15	Tetra Contour Light Guide 90° Inside Corner	Red	20/bag	
GERDXNLGO15	Tetra Contour Light Guide 90° Outside Corner	Red	20/bag	
GERDXNLGP15	Tetra Contour Light Guide 90° Planar Corner	Red	20/bag	
GEPOXNLGC15	Tetra Contour Light Guide Connector	Orange	20/bag	
GEPOXNLGEC15	Tetra Contour Light Guide End Cap	Orange	20/bag	
GEPOXNLGI15	Tetra Contour Light Guide 90° Inside Corner	Orange	20/bag	
GEPOXNLGO15	Tetra Contour Light Guide 90° Outside Corner	Orange	20/bag	
GEPOXNLGP15	Tetra Contour Light Guide 90° Planar Corner	Orange	20/bag	
GEYAXNLGC15	Tetra Contour Light Guide Connector	Yellow	20/bag	
GEYAXNLGEC15	Tetra Contour Light Guide End Cap	Yellow	20/bag	
GEYAXNLGI15	Tetra Contour Light Guide 90° Inside Corner	Yellow	20/bag	
GEYAXNLGO15	Tetra Contour Light Guide 90° Outside Corner	Yellow	20/bag	
GEYAXNLGP15	Tetra Contour Light Guide 90° Planar Corner	Yellow	20/bag	
GEGLXNLGEC15	Tetra Contour Light Guide End Cap	Green	20/bag	
GEGLXNLGC15	Tetra Contour Light Guide Connector	Green	20/bag	
GEGLXNLGI15	Tetra Contour Light Guide 90° Inside Corner	Green	20/bag	
GEGLXNLGO15	Tetra Contour Light Guide 90° Outside Corner	Green	20/bag	
GEGLXNLGP15	Tetra Contour Light Guide 90° Planar Corner	Green	20/bag	
GEBLXNLGEC15	Tetra Contour Light Guide End Cap	Blue	20/bag	
GEBLXNLGC15	Tetra Contour Light Guide Connector	Blue	20/bag	
GEBLXNLGI15	Tetra Contour Light Guide 90° Inside Corner	Blue	20/bag	
GEBLXNLGO15	Tetra Contour Light Guide 90° Outside Corner	Blue	20/bag	
GEBLXNLGP15	Tetra Contour Light Guide 90° Planar Corner	Blue	20/bag	
GEXNLGEC15	Tetra Contour Light Guide End Cap	White	20/bag	
GEXNLGC15	Tetra Contour Light Guide Connector	White	20/bag	
GEXNLGI15	Tetra Contour Light Guide 90° Inside Corner	White	20/bag	
GEXNLGO15	Tetra Contour Light Guide 90° Outside Corner	White	20/bag	
GEXNLGP15	Tetra Contour Light Guide 90° Planar Corner	White	20/bag	



# Tetra® Ti-10

## 24V 100W Power Supply

The Tetra Ti-10 is our first LED power supply designed, tested and built to last a decade. The 10 in its name stands for the standard 10-year warranty, the first in the signage industry.



### Features:

- Standard 10-year warranty
- Compatible with all 24VDC Tetra products
- UL: Class 2
- EC: SELV

Specifications	
Model	GEPS24-100U-TT
Nominal Voltage	120-277V ± 10%
Line Current	1.1-0.36A
Frequency	50/60Hz
Protection Class: (EU Class I/II/III)	Class II
Number of Output Channels	1
Output Voltage	24VDC ± 1VDC, per output channel
Output Power	96W, I <sub>out</sub> ≤ 4A, per output channel
Power Factor	>0.9 @ full load across nominal input voltage
THD	< 20% @ full load across nominal input voltage
Efficiency at Full Load	120VAC: 87% 230VAC: 89.6% 277VAC: 89.6%
Max. no. of PSU per MCB:	Available upon request
Operating Temperature Range, Ta	-40°C to 60°C
Operating Humidity	10% to 95% non-condensing
Storage Temperature Range	-40°C to 85°C
Max. Case Temperature at Tc Point:	85°C
Warranty @ 100% Duty Cycle, Tc=45°C	10 years
Dimmable:	No
Short Circuit Protection	Yes

Specifications	
Overload Protection	Yes
Over Temperature Protection	Yes
Environmental Rating	Dry and Damp Rated
Geometry (L×W×H)	9.5 in. x 1.7 in. x 1.1 in. (241 mm x 43.2 mm x 28 mm)
Weight	600 g
Suitable for Fixtures with Protection Class	UL Class 2
Safety	UL 879 UL 1310 CAN/CSA-C22.2 No. 207-15 CAN/CSA-C22.2 No.223
Radio Interference	FCC Part 15 Class A
Surge Capability	ANSI/IEEE C62.41 (1.2/50µs @ 6KV/2Ω L-N, 6KV/2Ω L+N-PE)
RoHS	Yes
Approvals (Certificates)	UL
Additional Notes	Not intended to operate in "No Load" mode



Electrical products must not be thrown out with domestic waste. They must be taken to a communal collecting point for environmentally friendly disposal in accordance with local regulations. Contact your local authorities or stockist for advice on recycling. The packaging material is recyclable. Dispose of the packaging in an environmentally friendly manner and make it available for the recyclable material collection-service

# GEPS24-100U-GLX2

## 24V 100W Power Supply

All Tetra® power supplies are designed specifically for the sign industry by our team of electronics experts. Tetra power supplies are built to stand the test of time, backed by the most extensive reliability testing in the industry and a five-year warranty.

### Features:

- Standard 5-year warranty
- Compatible with all 24VDC Tetra products
- UL: Class 2
- IEC: SELV



Specifications	
Model	GEPS24-100U-GLX2
Nominal Voltage	120-277V ± 10%
Line Current	1.1-0.36A
Frequency	50/60Hz
Protection Class: (EU Class I/II/III)	Class II
Number of Output Channels	1
Output Voltage	24VDC ± 1VDC, per output channel
Output Power	96W, I <sub>out</sub> ≤ 4A, per output channel
Power Factor	>0.9 @ full load across nominal input voltage
THD	< 20% @ full load across nominal input voltage
Efficiency at Full Load	120VAC: 87% 230VAC: 89.6% 277VAC: 89.6%
Max. no. of PSU per MCB:	Available upon request
Operating Temperature Range, T <sub>a</sub>	-40°C to 60°C
Operating Humidity	10% to 95% non-condensing
Storage Temperature Range	-40°C to 85°C
Max. Case Temperature at T <sub>c</sub> Point:	85°C
Warranty @ 100% Duty Cycle, T <sub>c</sub> =45°C	5 years
Dimmable:	No
Short Circuit Protection	Yes

Specifications	
Overload Protection	Yes
Over Temperature Protection	Yes
Environmental Rating	Dry and Damp Rated
Geometry (L×W×H)	9.5 in. x 1.7 in. x 1.1 in. (241 mm x 43.2 mm x 28 mm)
Weight	600 g
Suitable for Fixtures with Protection Class	UL Class 2
Safety	UL 879 UL 1310 CAN/CSA-C22.2 No. 207-15 CAN/CSA-C22.2 No.223
Radio Interference	FCC Part 15 Class A
Surge Capability	ANSI/IEEE C62.41 (1.2/50µs @ 6KV/2Ω L-N, 6KV/2Ω L+N-PE)
RoHS	Yes
Approvals (Certificates)	UL
Additional Notes	Not intended to operate in "No Load" mode



Electrical products must not be thrown out with domestic waste. They must be taken to a communal collecting point for environmentally friendly disposal in accordance with local regulations. Contact your local authorities or stockist for advice on recycling. The packaging material is recyclable. Dispose of the packaging in an environmentally friendly manner and make it available for the recyclable material collection-service

# GEPS24-200U-GLX2



## 24V 200W Power Supply

All Tetra® power supplies are designed specifically for the sign industry by our team of electronics experts. Tetra power supplies are built to stand the test of time, backed by the most extensive reliability testing in the industry and a five-year warranty.

### Features:

- Standard 5-year warranty
- Compatible with all 24VDC Tetra products
- UL: Class 2
- IEC: SELV

Specifications	
Model	GEPS24-200U-GLX2
Nominal Voltage	120-277V ± 10%
Line Current	1.92-0.83A
Frequency	50/60Hz
Protection Class: (EU Class I/II/III)	Class II
Number of Output Channels	2
Output Voltage	24VDC ± 1VDC, per output channel
Output Power	96W, I <sub>out</sub> ≤ 4A, per output channel
Power Factor	>0.9 @ full load across nominal input voltage
THD	< 20% @ full load across nominal input voltage
Efficiency at Full Load	120VAC: 87% 230VAC: 90.7% 277VAC: 90.7%
Max. no. of PSU per MCB:	Available upon request
Operating Temperature Range, Ta	-40°C to 60°C
Operating Humidity	10% to 95% non-condensing
Storage Temperature Range	-40°C to 85°C
Max. Case Temperature at Tc Point:	80°C
Warranty @ 100% Duty Cycle, Tc=45°C	5 years
Dimmable:	No
Short Circuit Protection	Yes

Specifications	
Overload Protection	Yes
Over Temperature Protection	Yes
Environmental Rating	Dry and Damp Rated
Geometry (L×W×H)	19.5 in. x 2.4 in. x 1.6 in. (495.5 mm x 61.6 mm x 40.2 mm)
Weight	1940 g
Suitable for Fixtures with Protection Class	UL Class 2, SELV
Safety	UL 879 UL 1310 CAN/CSA-C22.2 No. 207-15 CAN/CSA-C22.2 No.223 EN 61347-2-13, EN 61347-1
Radio Interference	FCC Part 15 Class A EN 55015, EN 61547, EN 61000-3-2; EN 61000-3-3
Surge Capability	ANSI/IEEE C62.41 (1.2/50µs @ 6KV/2Ω L-N, 6KV/2Ω L+N-PE)
RoHS	Yes
Approvals (Certificates)	UL, CE
Additional Notes	Not intended to operate in "No Load" mode



Electrical products must not be thrown out with domestic waste. They must be taken to a communal collecting point for environmentally friendly disposal in accordance with local regulations. Contact your local authorities or stockist for advice on recycling. The packaging material is recyclable. Dispose of the packaging in an environmentally friendly manner and make it available for the recyclable material collection-service

# GEPS24-300U-GLX2

## 24V 300W Power Supply

All Tetra® power supplies are designed specifically for the sign industry by our team of electronics experts. Tetra power supplies are built to stand the test of time, backed by the most extensive reliability testing in the industry and a five-year warranty.

### Features:

- Standard 5-year warranty
- Compatible with all 24VDC Tetra products
- UL: Class 2
- IEC: SELV



Specifications	
Model	GEPS24-300U-GLX2
Nominal Voltage	120-277V ± 10%
Line Current	2.55-1.1A
Frequency	50/60Hz
Protection Class: (EU Class I/II/III)	Class II
Number of Output Channels	3
Output Voltage	24VDC ± 1VDC, per output channel
Output Power	96W, I <sub>out</sub> ≤ 4A, per output channel
Power Factor	>0.9 @ full load across nominal input voltage
THD	< 20% @ full load across nominal input voltage
Efficiency at Full Load	120VAC: 87% 230VAC: 91.1% 277VAC: 91.1%
Max. no. of PSU per MCB:	Available upon request
Operating Temperature Range, T <sub>a</sub>	-40°C to 60°C
Operating Humidity	10% to 95% non-condensing
Storage Temperature Range	-40°C to 85°C
Max. Case Temperature at T <sub>c</sub> Point:	87°C
Warranty @ 100% Duty Cycle, T <sub>c</sub> =45°C	5 years
Dimmable:	No
Short Circuit Protection	Yes

Specifications	
Overload Protection	Yes
Over Temperature Protection	Yes
Environmental Rating	Dry and Damp Rated
Geometry (L×W×H)	15.7 in. x 5.1 in. x 1.3 in. (400.0 mm x 130.6 mm x 32.6 mm)
Weight	2230 g
Suitable for Fixtures with Protection Class	UL Class 2, SELV
Safety	UL 879 UL 1310 CAN/CSA-C22.2 No. 207-15 CAN/CSA-C22.2 No.223 EN 61347-2-13, EN 61347-1
Radio Interference	FCC Part 15 Class A EN 55015, EN 61547, EN 61000-3-2, EN 61000-3-3
Surge Capability	ANSI/IEEE C62.41 (1.2/50µs @ 6KV/2Ω L-N, 6KV/2Ω L+N-PE)
RoHS	Yes
Approvals (Certificates)	UL, CE
Additional Notes	Not intended to operate in "No Load" mode



Electrical products must not be thrown out with domestic waste. They must be taken to a communal collecting point for environmentally friendly disposal in accordance with local regulations. Contact your local authorities or stockist for advice on recycling. The packaging material is recyclable. Dispose of the packaging in an environmentally friendly manner and make it available for the recyclable material collection-service

White & colored products			Letter stroke	Max. Spacing between multiple strings			Halo lit**			
24V Tetra Module	Can Depth	Density (Mod/Ft)	Standard	Standard	Dark Vinyl	Perf. Vinyl	2X Can Depth	Density	Letter Stroke	
<b>Atom</b> (GEAM24XX-W1)	25mm	51mm	51mm	38mm			25mm	51mm	51mm	102mm
	38mm		102mm	64mm			38mm	76mm		
	51mm		152mm	127mm			51mm	102mm		
	76mm - <152mm		178mm				76mm - 127mm	N/A		
<b>MS</b> (GEMS24XX-W1)	38mm	51mm	102mm	76mm	76mm	76mm	76mm	76mm	102mm	
	51mm	61mm	127mm	102mm	76mm	76mm	102mm			
	64mm	76mm	165mm	140mm	114mm	89mm	127mm			
	76mm		203mm	178mm	152mm	127mm	152mm			
	102mm	76mm	279mm	254mm	229mm	203mm	203mm			
	≥127mm		356mm	330mm	305mm	305mm	N/A			N/A
<b>miniMAX</b> (GEMm <sup>2</sup> 4XX-W1)	38mm	76mm	102mm	76mm	76mm	76mm	76mm	122mm	102mm	
	51mm	102mm	127mm	102mm		102mm	102mm			
	64mm		165mm	140mm	114mm	89mm	127mm			
	76mm	122mm	203mm	178mm	152mm	127mm	152mm			
	102mm	152mm	279mm	254mm	229mm	203mm	203mm			
	≥127mm		356mm	330mm	305mm	305mm	N/A	N/A		
<b>MAX</b> (GEMX24XX-W1S)	76mm	152mm	203mm	178mm	152mm	127mm	152mm	203mm	102mm	
	102mm	203mm	279mm	254mm	229mm	203mm	203mm		127mm	
	127mm		356mm	330mm	305mm	279mm	254mm			
	≥152mm	432mm	406mm	381mm	356mm	N/A	N/A			
<b>PowerMAX</b> (GEPm <sup>2</sup> 4XX-W1)	76mm	152mm	203mm	178mm	152mm	127mm	152mm	203mm	102mm	
	102mm	203mm	279mm	254mm	229mm	203mm	203mm		127mm	
	127mm		356mm	330mm	305mm	279mm	254mm			
	≥152mm	432mm	406mm	381mm	356mm	N/A	N/A			
<b>Snap SS (-W1X) PowerMAX HO</b> (GEPmH24XX-W1CS1)	127mm	<b>Snap SS:</b> 203mm <b>PowerMAX HO:</b> 305mm	356mm	330mm	305mm	279mm	N/A Only used in special applications	TBD	127mm	
	152mm		432mm	406mm	381mm	356mm			152mm	
	178mm		483mm	457mm	432mm	406mm			N/A	
	≥203mm		533mm	508mm	483mm	457mm			N/A	

12V Select TX									
White & colored products			Letter stroke	Max. Spacing between multiple strings			Halo lit**		
	Can Depth	Density (Mod/Ft)	Standard	Standard	Dark Vinyl	Perf. Vinyl	2X Can Depth	Density	Letter Stroke
<b>Very Small</b> (GESEV65-3)	51mm	51mm	127mm	102mm	76mm	76mm	102mm	122mm	102mm
	76mm	102mm	178mm	152mm	127mm	127mm	152mm		152mm
	≥102mm	122mm	254mm	229mm	203mm	203mm	203mm		203mm
<b>Small</b> (GESES65-3)	76mm	102mm	178mm	178mm	152mm	152mm	152mm	178mm	178mm
	102mm	152mm	254mm	229mm	203mm	203mm	203mm		229mm
	127mm	178mm	330mm	305mm	279mm	279mm	N/A	N/A	N/A
	≥152mm		406mm	381mm	356mm	356mm			
<b>Medium</b> GESEM65-3 GESEMRD-2 GESEMBL-2 GESEMGL-2	76mm	102mm	178mm	178mm	152mm	152mm	152mm	203mm	178mm
	102mm	152mm	229mm	229mm	203mm	203mm	203mm		229mm
	127mm	203mm	330mm	305mm	279mm	279mm	254mm		305mm
	152mm		406mm	381mm	356mm	356mm	N/A	N/A	
	≥178mm		483mm	457mm	432mm	432mm			
<b>Large</b> (GESEL65-3)	102mm	152mm	254mm	229mm	203mm	203mm	203mm	203mm	229mm
	127mm	203mm (305mm)	330mm	305mm	279mm	279mm	254mm		305mm
	152mm		406mm	381mm	356mm	356mm	N/A	N/A	
	178mm		483mm	457mm	432mm	432mm			
	≥203mm	559mm	533mm	508mm	508mm				

\*\* Light travels into the sign and reflects back thus traveling twice (2x) the can depth.

Tetra LT									
White products			Letter stroke	Multiple strings			Halo lit		
Module	Can Depth	Density (Mod/ft)	Standard	Standard	Dark Vinyl	Perf. Vinyl	2X Can Depth	Density	Letter Stroke
LT Shallow	76mm	122mm (2.5 mod/305 mm)	178mm	152mm	127mm	127mm	152mm	122mm	102mm
	102mm	152mm (2 mod/ 305 mm)	254mm	229mm	203mm	203mm	203mm	152mm	102mm
	≥127mm		330mm	305mm	279mm	279mm	254mm	N/A	N/A
LT Medium	76mm	152mm (2 mod/ 305 mm)	178mm	152mm	127mm	127mm	152mm	203mm	102mm
	102mm		254mm	229mm	203mm	203mm	203mm		102mm
	127mm	203mm (1.5 mod/305 mm)	330mm	305mm	279mm	279mm	254mm		102mm
	≥152mm		406mm	381mm	356mm	356mm	N/A	N/A	N/A
LT Deep	102mm	203mm (1.5 mod/305 mm)	254mm	229mm	229mm	229mm	203mm	203mm	102mm
	127mm		330mm	305mm	305mm	305mm	254mm		102mm
	152mm	218mm (1.4 mod/305 mm)	406mm	381mm	381mm	381mm	N/A	N/A	N/A
	≥178mm		483mm	457mm	457mm	457mm			
LT Deep-E	≥178mm	305mm (1 mod/ 305 mm)	483mm	457mm	457mm	457mm	N/A	N/A	

## Cabinet Sign Guidelines

Tetra EdgeStrip																						
Width		Standard	HO	Standard	HO	Standard	HO	Standard	HO	Standard	HO	Standard	HO	Standard	HO							
305mm	Sides	1	1	1	1	1	1	1	2	1	2	1	2	1	1							
	Modules/side	1	1	2	1	3	1	4	1	5	1	6	1	7	7							
609mm	Sides	1	1	1	1	1	1	1	1	1	2	1	2	1	1							
	Modules/side	2	1	3	2	5	2	6	4	8	2	9	2	11	7							
914mm	Sides	1	1	1	2	2	1	2	1	2	1	2	1	2	1							
	Modules/side	3	1	5	1	5	3	6	4	8	5	9	6	11	7							
1219mm	Sides	1	2	1	1	2	1	4	2	4	2	4	2	4	2							
	Modules/side	4	1	6	4	6	4	6	4	6-8	4	6-9	4	6-11	7							
1524mm	Sides	1	2	1	2	2	1	4	2	Not recom.	2	Not recom.	2	Not recom.	2							
	Modules/side	5	1	8	2	8	5	6-8	4		5		5		7							
1829mm	Sides	1	2	1	2	2	1	4	2		2		2		6	7						
	Modules/side	6	1	9	2	9	6	6-9	4		5		6		7							
2134mm	Sides	1	1	1	1	2	1	4	2	2	2	2	Not recom.									
	Modules/side	7	7	11	7	11	7	6-11	7	7	7	7										
Height		305mm			609mm			914mm			1219mm			1524mm			1829mm			2134mm		

Recommended EdgeStrip can depth is 3-5". Recommended EdgeStrip HO can depth is 5-8". Please note that the spacing distances listed above are the maximum recommended. Smaller spacing distances can be used.

Tetra Slim EdgeStrip Spacing			
Modules/ft	Can Depth	Coverage (1 side)	Coverage (2 sides)
8.2	51mm	609mm	1219mm
6.6	76mm	609mm	1219mm
	≥102mm		

Tetra Snap	Depth	Max Stroke
Single Sided	127mm	330mm
	152mm	406mm
	178mm	457mm
	203mm	508mm
Double Sided	254mm- <305mm	330mm
	305mm - <356mm	406mm
	356mm- <406mm	457mm
	>406mm	508mm

Select TX Cuttable Light Bar / Tetra Rigid Light Bar		
Plastic and Fabric Faces	Depth	Space Between Bars
	51 mm	178 mm
	76 mm	305 mm
	102 mm	381 mm
	127 mm	457 mm

# Channel Letter

## Select TX™ – 12V

Power Output	Select TX Gen 3 L	Select TX Gen 3 M	Select TX Gen 3 S	Select TX Gen 3 VS	Select TX Gen 2 Red	Select TX Gen 2 Blue	Select TX Gen 2 Green
60W	38 modules/ 25.3 ft. (7.7 m)	50 modules/ 33.4 ft. (10.2 m)	76 modules/ 44.7 ft. (13.6 m)	150 modules/ 60 ft. (18.3 m)	100 modules/ 66.67 ft. (20.32 m)	60 modules/ 40 ft. (12.19 m)	80 modules/ 53.33 ft. (16.26 m)
Watts per module	1.6W/Module	1.2W/Module	0.8W/Module	0.4W/Module	0.516W/Module	0.78W/Module	0.672W/Module

## Tetra® Tape – 12V

Power Output	Configuration	Tetra Tape	Tetra Tape HO	Tetra Tape Red	Tetra Tape Green	Tetra Tape Blue
25W	–	4m/13 ft	2m/6.5 ft	5m/16.4 ft.	7m/23 ft.	4m/13 ft.
60W	–	10m/32.8 ft.	4m/13 ft.	12m/39 ft	15m/49 ft	10m/32.8 ft.
180W	Per bank	10m/32.8 ft.	4m/13 ft.	12m/39 ft	15m/49 ft	10m/32.8 ft.
	Per PS	30m/98.4 ft.	12m/39 ft	36m/117 ft	45m/147 ft	30m/98.4 ft.
Watts per foot		1.37W/ft	3.3W/ft	1.06W/ft.	0.73W/ft	1.37W/ft.

## Tetra® LT– 24V

Power Output	Configuration	LT Shallow	LT Medium	LT Deep
25W		62 modules/31 ft (9 m)	31 modules/21 ft (6 m)	20 modules/14 ft (4 m)
80W		200 modules/100 ft (30 m)	100 modules/67 ft (20 m)	66 modules/47 ft (14 m)
100W		230 modules/115 ft (35m)	114 modules/71 ft (22 m)	76 modules/54 ft (17 m)
200W	Per Bank	230 modules/115 ft (35m)	114 modules/71 ft (22 m)	76 modules/54 ft (17 m)
	Per PS	460 modules/230 ft (70m)	228 modules/142 ft (44 m)	152 modules/108 ft (34 m)
300W	Per Bank	230 modules/115 ft (35m)	114 modules/71 ft (22 m)	76 modules/54 ft (17 m)
	Per PS	690 module/345 ft (105 m)	342 modules/213 ft (66 m)	228 modules/162 ft (51 m)
Watts per module		0.36 W/module	0.72 W/module	1.08 W/module

## Tetra® White– 24V

Power Output	Configuration	PowerMAX HO *	PowerMAX	MAX	MiniMAX	MS	Atom
25W	–	17 modules/ 34 ft. (10 m)	25 modules/ 17 ft. (5.18 m)	33 modules/ 22 ft. (6.7 m)	58 modules/ 29 ft. (9.14 m)	90 modules/ 22.5 ft. (6.86 m)	75 modules/ 12.5 ft. (3.81 m)
80W	–	54 modules/ 108 ft. (33 m)	80 modules/ 53 ft. (16.15 m)	110 modules/ 73 ft. (22.35 m)	184 modules/ 92 ft. (28.95 m)	282 modules/ 70.5 ft. (21.49 m)	240 modules/ 40 ft. (12.19 m)
100W	–	64 modules/ 108 ft. (33 m)	96 modules/ 64 ft. (19.5 m)	130 modules/ 87 ft. (26.42 m)	220 modules/ 110 ft. (35.05 m)	340 modules/ 85 ft. (25.91 m)	300 modules/ 50 ft. (15.24 m)
180W	Per bank	60 modules/ 120 ft. (36.5 m)	90 modules/ 60 ft. (18.29 m)	120 modules/ 80 ft. (24.38 m)	210 modules/ 105 ft. (33.5 m)	320 modules/ 80 ft. (24.38 m)	270 modules/ 45 ft. (13.72 m)
	Per PS	120 modules/ 240 ft. (73 m)	180 modules/ 120 ft. (36.58 m)	240 modules/ 160 ft. (48.77 m)	420 modules/ 210 ft. (67.05 m)	640 modules/ 160 ft. (48.76 m)	540 modules/ 90 ft. (27.43 m)
300W	Per bank	64 modules/ 128 ft. (39 m)	96 modules/ 64 ft. (19.5 m)	130 modules/ 87 ft. (26.42 m)	220 modules/ 110 ft. (35.05 m)	340 modules/ 85 ft. (25.91 m)	300 modules/ 50 ft. (15.24 m)
	Per PS	192 modules/ 384 ft. (117 m)	288 modules/ 192 ft. (58.52 m)	390 modules/ 260 ft. (79.25 m)	660 modules/ 330 ft. (105.15 m)	1020 modules/ 255 ft. (77.72 m)	900 modules/ 150 ft. (45.72 m)
Watts per module		1.2W/module	0.84W/module	0.62W/module	0.35W/module	0.24W/module	0.25W/module

\*N.B. Lengths provided are based on tied wire

## Tetra® Colors – 24V

Power Output	Configuration	MAX Red	MAX Red HO	MAX Green	MAX Blue	MAX Amber	MiniMAX Red	MiniMAX Green	MiniMAX Blue
25W	–	47 modules/ 31.3 ft. (9.55 m)	29 modules/ 19.3 ft. (5.89 m)	28 modules/ 18.7 ft. (5.69 m)	31 modules/ 20.7 ft. (6.3 m)	56 modules/ 37.3 ft. (11.38 m)	64 modules/ 32 ft. (9.75 m)	37 modules/ 18.5 ft. (5.64 m)	40 modules/ 20 ft. (6.1 m)
80W	–	150 modules/ 100 ft. (30.48 m)	92 modules/ 61.3 ft. (18.69 m)	89 modules/ 59.3 ft. (18.08 m)	98 modules/ 65.3 ft. (19.91 m)	180 modules/ 120 ft. (36.58 m)	205 modules/ 102.5 ft. (31.24 m)	118 modules/ 59 ft. (17.98 m)	130 modules/ 65 ft. (19.81 m)
100W	–	180 modules/ 120 ft. (36.58 m)	110 modules/ 73.3 ft. (22.35 m)	107 modules/ 71.3 ft. (21.74 m)	118 modules/ 78.6 ft. (23.98 m)	210 modules/ 140 ft. (42.67 m)	240 modules/ 120 ft. (36.58 m)	142 modules/ 71 ft. (21.64 m)	155 modules/ 77.5 ft. (23.62 m)
180W	Per bank	168 modules/ 112 ft. (34.14 m)	103 modules/ 68.7 ft. (20.93 m)	100 modules/ 66.7 ft. (20.32 m)	110 modules/ 73.3 ft. (22.35 m)	200 modules/ 133.3 ft. (40.64 m)	228 modules/ 114 ft. (34.75 m)	132 modules/ 66 ft. (20.12 m)	146 modules/ 73 ft. (22.25 m)
	Per PS	336 modules/ 224 ft. (68.27 m)	206 modules/ 137.3 ft. (41.86 m)	200 modules/ 133.3 ft. (40.64 m)	220 modules/ 146.7 ft. (44.7 m)	400 modules/ 266.7 ft. (81.28 m)	456 modules/ 228 ft. (69.49 m)	264 modules/ 132 ft. (40.23 m)	292 modules/ 146 ft. (44.5 m)
300W	Per bank	180 modules/ 120 ft. (36.58 m)	110 modules/ 73.3 ft. (22.35 m)	107 modules/ 71.3 ft. (21.74 m)	118 modules/ 78.6 ft. (23.98 m)	210 modules/ 140 ft. (42.67 m)	240 modules/ 120 ft. (36.58 m)	142 modules/ 71 ft. (21.64 m)	155 modules/ 77.5 ft. (23.62 m)
	Per PS	540 modules/ 360 ft. (109.7 m)	330 modules/ 220 ft. (67 m)	321 modules/ 214 ft. (65.23 m)	354 modules/ 236 ft. (71.93 m)	630 modules/ 420 ft. (128 m)	720 modules/ 360 ft. (109.7 m)	426 modules/ 213 ft. (64.92 m)	465 modules/ 232.5 ft. (70.87 m)
Watts per module		0.456W/ module	0.744W/ module	0.768W/ module	0.696W/ module	0.384W/ module	0.336W/ module	0.576W/ module	0.528W/ module

## Tetra® Colors – 24V

### Tetra® Snap SS – 24V

Power Output	Configuration	Number of modules
25W	–	17 modules
80W	–	52 modules
100W	–	64 modules
180W	Per bank	60 modules
	Per PS	120 modules
300W	Per bank	64 modules
	Per PS	192 modules
Watts per module		1.30W/module

### Tetra® Snap DS – 24V

Power Output	Configuration	Number of modules
25W	–	8 modules
80W	–	26 modules
100W	–	32 modules
180W	Per bank	29 modules
	Per PS	58 modules
300W	Per bank	32 modules
	Per PS	96 modules
Watts per module		2.59W/module

### Tetra® EdgeStrip – 24V

Power Output	Configuration	EdgeStrip	EdgeStrip HO
25W	–	9 modules/9 ft. (2.74 m)	4 modules/4ft. (1.22 m)
80W	–	30 modules/30 ft. (9.15 m)	14 modules/14 ft. (4.27 m)
100W	–	36 modules/36 ft. (10.97 m)	17 modules/18 ft. (5.49 m)
180W	Per bank	33 modules/33 ft. (10.06 m)	16 modules/16 ft. (4.88 m)
	Per PS	66 modules/66 ft. (20.12 m)	32 modules/32 ft. (9.75 m)
300W	Per bank	36 modules/36ft. (10.98m)	17 modules/18ft. (5.49 m)
	Per PS	108 modules/108 ft. (32.94 m)	51 modules/54 ft. (16.46 m)
Watts per module		2.52W/module	5.40W/module

## Tetra® Slim EdgeStrip – 24V

Power Output	Configuration	Slim EdgeStrip	Slim EdgeStrip HO
25W	–	15 modules/9.87 ft.	10 modules/6.6 ft.
80W	–	48 modules/31.6 ft.	32 modules/21 ft.
100W	–	57 modules/37.5 ft.	38 modules/25 ft.
180W	Per bank	53 modules/34.9 ft.	36 modules/20.4 ft.
	Per PS	106 modules/69.8 ft.	72 modules/40.8 ft.
300W	Per bank	57 modules/37.5 ft.	38 modules/25 ft.
	Per PS	171 modules/112.7 ft.	114 modules/75 ft.
Watts per module		1.44 W/module	2.16 W/module

## Tetra® Edgeline – 24V

Power Output	Configuration	Number of Bars
25W	–	1 bars / 3 ft. 11.4 in. (1.20 m)
80W	–	4 bars / 15 ft. 9.5 in. (4.81 m)
100W	–	5 bars / 19 ft. 9 in. (6.02 m)
200W	Per bank	5 bars / 19 ft. 9 in. (6.02 m)
	Per PS	10 bars / 39 ft. 6 in. (12.04 m)
300W	Per bank	5 bars / 19 ft. 9 in. (6.02 m)
	Per PS	15 bars / 59 ft. 3 in. (18.06 m)
Watts per bar		16.7W / Bar

## Tetra® Colors – 24V

### Tetra® Contour LS – 24V

Power Output	Configuration	Red	Green, Blue	Whites
25W	–	16 ft. (4.88 m)	12 ft. (3.66 m)	6 ft. (1.83 m)
80W	–	58 ft. (17.68 m)	44 ft. (13.41 m)	24 ft. (7.3 m)
100W	–	69 ft. (21m)	52 ft. (15.85 m)	29 ft. (8.8 m)
180W	Per bank	65 ft. (19.81 m)	48 ft. (14.63 m)	27 ft. (8.2 m)
	Per PS	130 ft. (39.62 m)	96 ft. (29.26 m)	54 ft. (16.4 m)
300W	Per bank	69 ft. (21 m) p	52 ft. (15.8 m)	29 ft. (8.8 m)
	Per PS	207 ft. (63 m)	156 ft. (47.5 m)	87 ft. (26.5 m)
Watts per foot		1.30W/ft.	1.73W/ft.	3.17W/ft.

### Tetra® Contour Flex / Gen 2 – 24V

Power Output	Configuration	Flex	Gen 2: Whites, Green, Blue, Amber, Red-Orange / Red
25W	–	15 ft. (4.6 m)	11 ft. (3.4 m) / 15 ft. (4.6 m)
80W	–	49 ft. (15 m)	36 ft. (11 m) / 49 ft. (15 m)
100W	–	59 ft. (18 m)	44 ft. (13.4 m) / 59 ft. (18 m)
200W	Per bank	59 ft. (18 m)	44 ft. (13.4 m) / 59 ft. (18 m)
	Per PS	118 ft. (36 m)	88 ft. (27 m) / 118 ft. (36 m)
300W	Per bank	59 ft. (18 m)	44 ft. (13.4 m) / 59 ft. (18 m)
	Per PS	177 ft. (54 m)	132 ft. (40 m) / 177 ft. (54 m)
Watts per foot		1.4 W/ft	1.9 W/ft / 1.4 W/ft

N.B. Only use Tetra power supplies with Tetra LED lighting systems

## Channel Letter



### Tetra® White – 24V

Power Output	Configuration	PowerMAX HO *	PowerMAX	MAX	MiniMAX	MS	Atom
25W	–	17 modules/ 34 ft. (10 m)	25 modules/ 17 ft. (5.18 m)	33 modules/ 22 ft. (6.7 m)	58 modules/ 29 ft. (9.14 m)	90 modules/ 22.5 ft. (6.86 m)	75 modules/ 12.5 ft. (3.81 m)
80W	–	54 modules/ 108 ft. (33 m)	80 modules/ 53 ft. (16.15 m)	110 modules/ 73 ft. (22.35 m)	184 modules/ 92 ft. (28.95 m)	282 modules/ 70.5 ft. (21.49 m)	240 modules/ 40 ft. (12.19 m)
100W	–	72 modules/ 72 ft. (21.9 m)	103 modules/ 68.6 ft. (20.9 m)	139 modules/ 92.6 ft. (28.2 m)	237 modules/ 118.5 ft. (36.1 m)	362 modules/ 90.5 ft. (27.5 m)	327 modules/ 54.5 ft. (16.6 m)
200W	Per bank	72 modules/ 72 ft. (21.9 m)	103 modules/ 68.6 ft. (20.9 m)	139 modules/ 92.6 ft. (28.2 m)	237 modules/ 118.5 ft. (36.1 m)	362 modules/ 90.5 ft. (27.5 m)	327 modules/ 54.5 ft. (16.6 m)
	Per PS	144 modules/ 144 ft. (43.9 m)	206 modules/ 137 ft. (41.7 m)	278 modules/ 185 ft. (56.3 m)	474 modules/ 237 ft. (72.2 m)	724 modules/ 181 ft. (55.1 m)	654 modules/ 109 ft. (33.2 m)
300W	Per bank	72 modules/ 72 ft. (21.9 m)	103 modules/ 68.6 ft. (20.9 m)	139 modules/ 92.6 ft. (28.2 m)	237 modules/ 118.5 ft. (36.1 m)	362 modules/ 90.5 ft. (27.5 m)	327 modules/ 54.5 ft. (16.6 m)
	Per PS	216 modules/ 216 ft. (65.8 m)	309 modules/ 206 ft. (62.7 m)	417 modules/ 278 ft. (84.7 m)	711 modules/ 355 ft. (108.2 m)	1086 modules/ 271 ft. (82.6 m)	981 modules/ 163.5 ft. (49.8 m)
Watts per module		1.2W/module	0.84W/module	0.62W/module	0.35W/module	0.24W/module	0.25W/module

\*N.B. Lengths provided are based on tied wire

### Tetra® Colors – 24V

Power Output	Configuration	MAX Red	MAX Red HO	MAX Green	MAX Blue	MAX Amber	MiniMAX Red	MiniMAX Green	MiniMAX Blue
25W	–	47 modules/ 31.3 ft. (9.55 m)	29 modules/ 19.3 ft. (5.89 m)	28 modules/ 18.7 ft. (5.69 m)	31 modules/ 20.7 ft. (6.3 m)	56 modules/ 37.3 ft. (11.38 m)	64 modules/ 32 ft. (9.75 m)	37 modules/ 18.5 ft. (5.64 m)	40 modules/ 20 ft. (6.1 m)
80W	–	150 modules/ 100 ft. (30.48 m)	92 modules/ 61.3 ft. (18.69 m)	89 modules/ 59.3 ft. (18.08 m)	98 modules/ 65.3 ft. (19.91 m)	180 modules/ 120 ft. (36.58 m)	205 modules/ 102.5 ft. (31.24 m)	118 modules/ 59 ft. (17.98 m)	130 modules/ 65 ft. (19.81 m)
100W	–	190 modules/ 126.6 ft. (38.5 m)	116 modules/ 77.3 ft. (23.5 m)	113 modules/ 75.3 ft. (22.9 m)	124 modules/ 82.6 ft. (25.1 m)	226 modules/ 150.6 ft. (45.9 m)	258 modules/ 129 ft. (39.3 m)	150 modules/ 75 ft. (22.8 m)	164 modules/ 82 ft. (25 m)
200W	Per bank	190 modules/ 126.6 ft. (38.5 m)	116 modules/ 77.3 ft. (23.5 m)	113 modules/ 75.3 ft. (22.9 m)	124 modules/ 82.6 ft. (25.1 m)	226 modules/ 150.6 ft. (45.9 m)	258 modules/ 129 ft. (39.3 m)	150 modules/ 75 ft. (22.8 m)	164 modules/ 82 ft. (25 m)
	Per PS	380 modules/ 253.3 ft. (77.2 m)	232 modules/ 154.6 ft. (47.1 m)	226 modules/ 150.6 ft. (45.9 m)	248 modules/ 165.3 ft. (50.3 m)	452 modules/ 301.3 ft. (91.8 m)	516 modules/ 258 ft. (78.6 m)	300 modules/ 150 ft. (45.7 m)	328 modules/ 164 ft. (50 m)
300W	Per bank	190 modules/ 126.6 ft. (38.5 m)	116 modules/ 77.3 ft. (23.5 m)	113 modules/ 75.3 ft. (22.9 m)	124 modules/ 82.6 ft. (25.1 m)	226 modules/ 150.6 ft. (45.9 m)	258 modules/ 129 ft. (39.3 m)	150 modules/ 75 ft. (22.8 m)	164 modules/ 82 ft. (25 m)
	Per PS	570 modules/ 380 ft. (115.8 m)	348 modules/ 232 ft. (70.7 m)	339 modules/ 226 ft. (68.8 m)	372 modules/ 248 ft. (75.6 m)	678 modules/ 452 ft. (137.7 m)	774 modules/ 387 ft. (117.9 m)	450 modules/ 225 ft. (68.5 m)	492 modules/ 246 ft. (75 m)
Watts per module		0.456W/ module	0.744W/ module	0.768W/ module	0.696W/ module	0.384W/ module	0.336W/ module	0.576W/ module	0.528W/ module

# Tetra® LT- 24V

Power Output	Configuration	LT Shallow	LT Medium	LT Deep
25W		62 modules/31 ft (9 m)	31 modules/21 ft (6 m)	20 modules/14 ft (4 m)
80W		200 modules/100 ft (30 m)	100 modules/67 ft (20 m)	66 modules/47 ft (14 m)
100W		240 modules/120 ft (37m)	120 modules/80 ft (24 m)	80 modules/57 ft (17 m)
200W	Per Bank	240 modules/120 ft (37m)	120 modules/80 ft (24 m)	80 modules/57 ft (17 m)
	Per PS	480 modules/240 ft (73 m)	240 modules/ 160 ft (49 m)	160 modules/114 ft (35 m)
300W	Per Bank	240 modules/120 ft (37m)	120 modules/80 ft (24 m)	80 modules/57 ft (17 m)
	Per PS	720 modules/360 ft (110 m)	360 modules/240 ft (73 m)	240 modules/171 ft (52 m)
Watts per module		0.4 W/module	0.79 W/module	1.19 W/module

## Cabinet Signs



### Tetra® Snap SS – 24V

Power Output	Configuration	Number of modules
25W	–	17 modules
80W	–	52 modules
100W	–	66 modules
200W	Per bank	66 modules
	Per PS	132 modules
300W	Per bank	66 modules
	Per PS	198 modules
Watts per module		1.30W/module

### Tetra® Snap DS – 24V

Power Output	Configuration	Number of modules
25W	–	8 modules
80W	–	26 modules
100W	–	33 modules
200W	Per bank	33 modules
	Per PS	66 modules
300W	Per bank	33 modules
	Per PS	99 modules
Watts per module		2.59W/module

### Tetra® EdgeStrip – 24V

Power Output	Configuration	EdgeStrip	EdgeStrip HO
25W	–	9 modules/9 ft. (2.74 m)	4 modules/4 ft. (1.22 m)
80W	–	30 modules/30 ft. (9.15 m)	14 modules/14 ft. (4.27 m)
100W	–	36 modules/36 ft. (10.97 m)	17 modules/17 ft. (5.18 m)
200W	Per bank	36 modules/36 ft. (10.97 m)	17 modules/17 ft. (5.18 m)
	Per PS	72 modules/72 ft. (21.94 m)	34 modules/34 ft. (10.36 m)
300W	Per bank	36 modules/36 ft. (10.97 m)	17 modules/17 ft. (5.18 m)
	Per PS	108 modules/108 ft. (32.94 m)	51 modules/54 ft. (16.46 m)
Watts per module		2.52W/module	5.40W/module

# Contour

## Tetra® Contour LS – 24V

Power Output	Configuration	Red	Green, Blue	Whites
25W	–	16 ft. (4.88 m)	12 ft. (3.66 m)	6 ft. (1.83 m)
80W	–	58 ft. (17.68 m)	44 ft. (13.41 m)	24 ft. (7.3 m)
100W	–	69 ft. (21m)	52 ft. (15.85 m)	29 ft. (8.8 m)
180W	Per bank	65 ft. (19.81 m)	48 ft. (14.63 m)	27 ft. (8.2 m)
	Per PS	130 ft. (39.62 m)	96 ft. (29.26 m)	54 ft. (16.4 m)
300W	Per bank	69 ft. (21 m) p	52 ft. (15.8 m)	29 ft. (8.8 m)
	Per PS	207 ft. (63 m)	156 ft. (47.5 m)	87 ft. (26.5 m)
Watts per foot		1.30W/ft.	1.73W/ft.	3.17W/ft.

## Tetra® Contour Flex / Gen 2 – 24V

Power Output	Configuration	Flex	Gen 2: Whites, Green, Blue, Amber, Red-Orange / Red
25W	–	15 ft. (4.6 m)	11 ft. (3.4 m) / 15 ft. (4.6 m)
80W	–	49 ft. (15 m)	36 ft. (11 m) / 49 ft. (15 m)
100W	–	62ft. (19 m)	46 ft. (14 m) / 62ft. (19 m)
200W	Per bank	62ft. (19 m)	46 ft. (14 m) / 62ft. (19 m)
	Per PS	124 ft. (38 m)	92 ft. (28 m) / 124 ft. (38 m)
300W	Per bank	62ft. (19 m)	46 ft. (14 m) / 62ft. (19 m)
	Per PS	186 ft. (57 m)	138 ft. (42 m) / 186 ft. (57 m)
Watts per foot		1.4 W/ft	1.9 W/ft / 1.4 W/ft

N.B. Only use Tetra power supplies with Tetra LED lighting systems

GESEL65-3

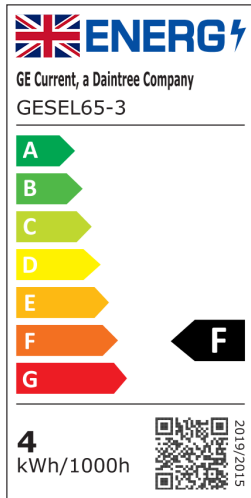
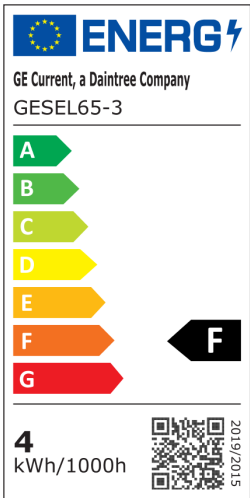

GESEL65-3E

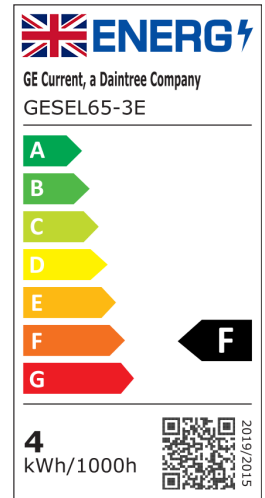
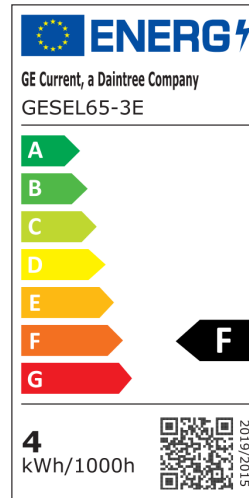

GESEM65-3

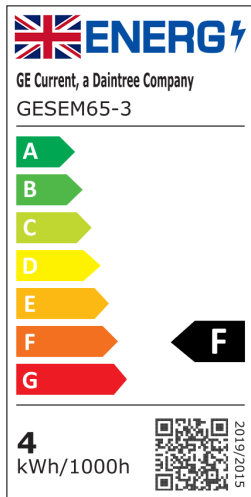
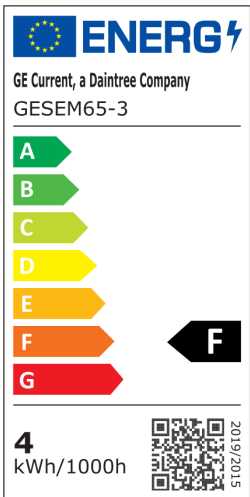

GESES65-3

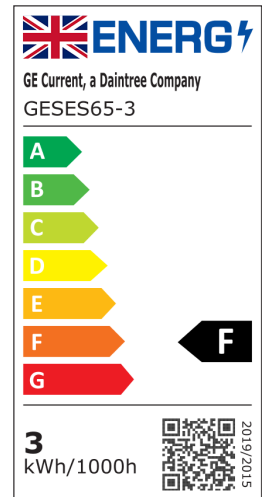
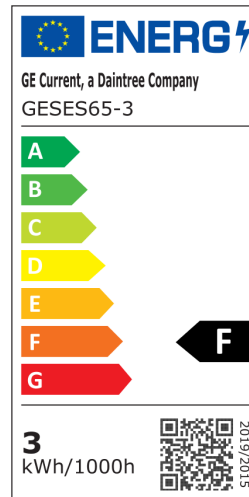

GESEV65-3

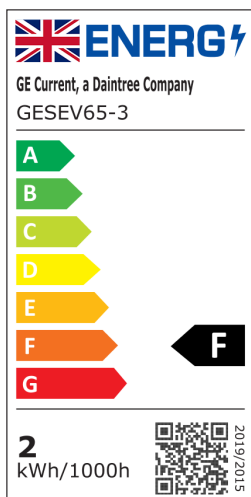
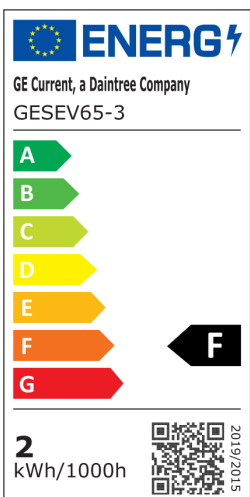

For sign use only. Not intended for general lighting applications.

This product is considered to be a "containing product" with a length nearest to 50 cm being considered the "light source" per Regulations (EU) 2019/2020 and (EU) 2019/2015.

As the final application permits, without permanent damage to the containing product and with the use of commonly available tools; as specified in the install instructions, the contained LED light source may be cut out, removed from the mounting surface, and replaced or dismantled at the end of life, by a professional installer.



Electrical products must not be thrown out with domestic waste. They must be taken to a communal collection point for environmentally friendly disposal in accordance with local regulations. Contact your local authorities or stockist for advice on recycling. The packaging material is recyclable. Dispose of the packaging in an environmentally friendly manner and make it available for the recyclable material collection-service.



# Table of Contents

Tetra® Atom	4
Tetra® MS	8
Tetra® MiniMAX	12
Tetra® MAX	16
Tetra® PowerMAX	20
Tetra® LT	24
Select TX® Gen 3	28
Tetra® Tape Gen 2	32
Tetra® Snap DS	36
Tetra® Snap SS	40
Tetra® EdgeStrip	44
Tetra® Slim EdgeStrip	48
Tetra® Contour Flex	52
Tetra® Contour Gen 2	56
Tetra® LED Power Supplies	60
Spacing Guidelines	64
Loading Charts	66
EPREL Label Example	72

# Get in touch to learn more about our family of innovation in LED signage lighting

1.888.694.3533  
[LED.com/signage](https://www.led.com/signage)







# Tetra<sup>®</sup> PowerMAX HO

CHANNEL LETTER LIGHTING SYSTEMS

With powerful OptiLens™ X  
and groundbreaking energy  
efficiency

**Tetra<sup>®</sup>PowerMAX HO**— the remarkable 24V LED system designed for channel letters as shallow as 4 inches in depth, as well as single-sided cabinet signs, delivers incredibly uniform light, installs easily and operates efficiently. **Tetra<sup>®</sup>PowerMAX** is now IP66 and UL wet rated which makes it more robust and reliable than ever, even under wet weather.

patented  
viewing  
otherwise  
designs

to 64  
types of

ing

X



## Table of contents Features

Wide 170° beam angle

Efficacy: 150 lm/W

24 Volt DC, Class 2 (UL), Class III (IEC)

UL Wet Rated & IP66

10-year limited warranty

## Tetra® PowerMAX HO Spacing

	Can Depth	Coverage
<b>Large</b>	6" (152mm)	17" (431.8mm)
	7" (178 mm)	19" (483 mm)
	≥ 8" (203 mm)	21" (533 mm)

## Total Reliability

To ensure every **Tetra® PowerMAX HO** installation will operate brilliantly for years, we perform the most extensive, stringent testing in the industry. We test the LED, water and dust ingress protection, sub-system and complete system at our in-house and independent laboratories around the world. Validation of our designs, components, products and processes include high temperature, high humidity and accelerated life testing.



## Mechanical Outline & Viewing Angle

Dimensions in (inches). Metric equivalent mm

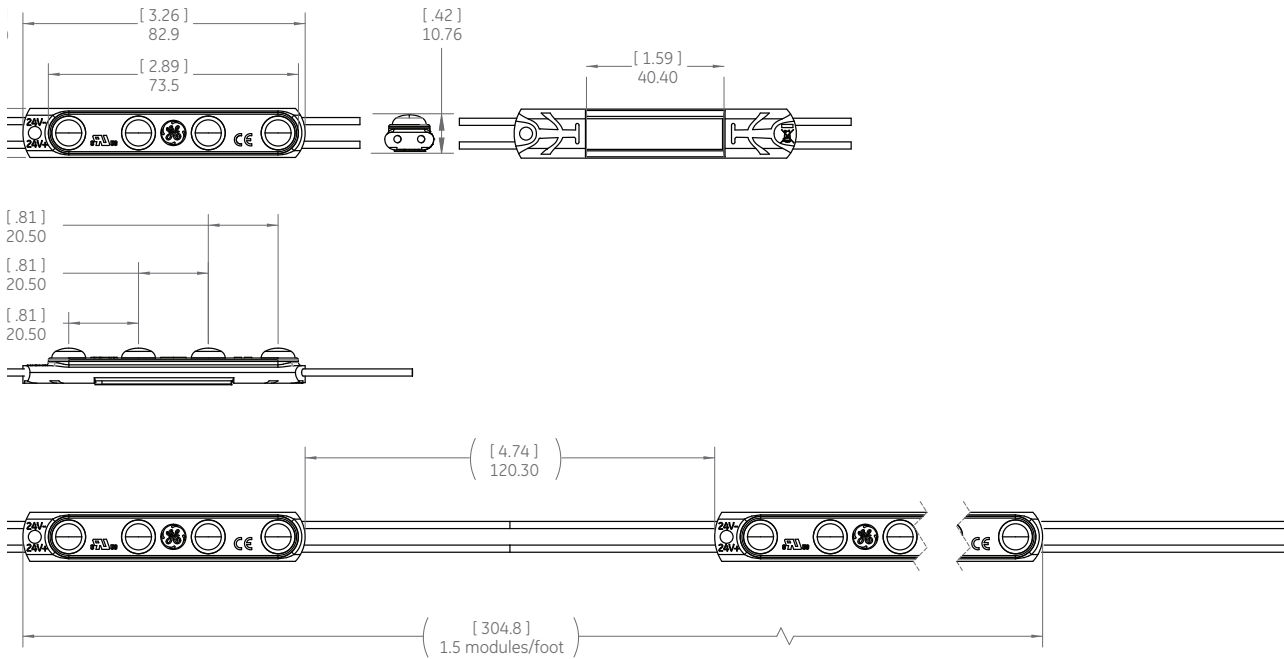

## Viewing angles

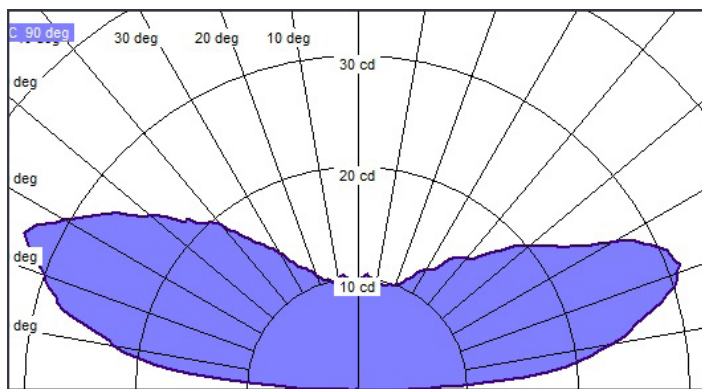

## Accessories

SKU	Description	Package quantity
GETMEC1	18 AWG Wire End Caps (0.82 mm <sup>2</sup> )	100/bag
9409	18 AWG Supply Wire (0.82 mm <sup>2</sup> )	500 ft (152.40m)/spool
191600041	22-14 AWG Twist-on Wire Connector (0.33-2.08 mm <sup>2</sup> )	500/bag
192160004	18-14 AWG In-line Splice Connector (0.82-2.08 mm <sup>2</sup> )	500/bag

# Components

SKU	Model	Details	Color	Pkg. Quantity	Modules per strip
93132009	GEPMH2471-W1B	Tetra® PowerMAX HO 24V 7100K	White	600 Modules/Box	1.5 Modules/ft (5 Modules/m)
93067977	GEPMH2471-W1CS1	Tetra® PowerMAX HO 24V 7100K	White	5 Strips/Box	35 modules per strip (70 ft/strip)
93118731	GEPMH2465-W1CS1	Tetra® PowerMAX HO 24V 6500K	Warm White	5 Strips/Box	35 modules per strip (70 ft/strip)
93067978	GEPMH2450-W1CS1	Tetra® PowerMAX HO 24V 5000K	Warm White	5 Strips/Box	35 modules per strip (70 ft/strip)
93067979	GEPMH2441-W1CS1	Tetra® PowerMAX HO 24V 4100K	Warm White	5 Strips/Box	35 modules per strip (70 ft/strip)
93067980	GEPMH2432-W1CS1	Tetra® PowerMAX HO 24V 3200K	Warm White	5 Strips/Box	35 modules per strip (70 ft/strip)

## Technical Specifications

Model	Wavelength/ CCT	Typical Brightness Lumens/module	Typical Brightness Lumens/Ft (Lumens/m)	Energy Consumption Module Wattage	Energy Consumption System Wattage	100W GLX Power Supply Loading	Viewing Angle
GEPMH2471-W1B	7100K	180	270 (900)	1.2 W/module	1.41 W/module	43 ft (13 m)	170°
GEPMH2471-W1CS1	7100K	180	180 (590)	1.2 W/module	1.41 W/module	64 ft (19.5 m)	170°
GEPMH2465-W1CS1	6500K	180	180 (590)	1.2 W/module	1.41 W/module	64 ft (19.5 m)	170°
GEPMH2450-W1CS1	5000K	180	180 (590)	1.2 W/module	1.41 W/module	64 ft (19.5 m)	170°
GEPMH2441-W1CS1	4100K	180	180 (590)	1.2 W/module	1.41 W/module	64 ft (19.5 m)	170°
GEPMH2432-W1CS1	3200K	160	160 (525)	1.2 W/module	1.41 W/module	64 ft (19.5 m)	170°

## Additional Specifications

	Specification (Tied Wire)	Specification (Stretched Wire)	Specification (W1B)		
LEDs/Module	4	4	4		
LEDs/ft (LEDs/m)	4 (13.1)	2 (6.6)	6 (20)		
Modules/ ft. (Modules/m)	1.0 (3.3)	0.5 (1.6)	1.5 (5)		
Cutting Resolution	Cut on wire between every module				
Power Supply	GEPS24-25U Input: 100-305VAC; Output: 24VDC GEPS24D-60U Input: 90-305VAC; Output: 24VDC GEPS24-100U Input: 108-305VAC; Output: 24VDC GEPS24-150U Input: 176-305VAC; Output: 24VDC GEPS24-200U Input: 90-305VAC; Output: 24VDC GEPS24-300U Input: 108-305VAC; Output: 24VDC				
Maximum Supply Wire Limits		18 AWG/0.82 mm <sup>2</sup> Supply Wire	16 AWG/1.31 mm <sup>2</sup> Supply Wire	14 AWG/2.08 mm <sup>2</sup> Supply Wire	12 AWG/3.31 mm <sup>2</sup> Supply Wire
	25W Power Supply	120 ft./36.6 m	/	/	/
	60W Power Supply	20 ft./6.1 m	25 ft./7.6 m	35 ft./10.6 m	40 ft./12.1 m
	100W Power Supply	20 ft./6.1 m	25 ft./7.6 m	35 ft./10.6 m	40 ft./12.1 m
	150W Power Supply	20 ft./6.1 m	25 ft./7.6 m	35 ft./10.6 m	40 ft./12.1 m
	200W Power Supply	20 ft./6.1 m	25 ft./7.6 m	35 ft./10.6 m	40 ft./12.1 m
300W Power Supply	20 ft./6.1 m	25 ft./7.6 m	35 ft./10.6 m	40 ft./12.1 m	
Operating Environment	-40 °C to +60 °C (-40 °F to +140 °F)				
Module Dimensions (h x l x w)	.42" x 3.26" x 0.57" (10.76 mm x 82.9 mm x 14.4 mm)				
Warranty	Limited system warranty of up to ten (10) years				
System Certifications	UL Recognized #E219167, UL Classified #E229508, CE, UKCA, IP66, Acceptable to use in dry, damp, and wet locations.				





# Tetra<sup>®</sup> miniMAX CRI90+

ARCHITECTURAL LIGHTING SYSTEMS

With powerful OptiLens™ X  
and groundbreaking energy  
efficiency

Tetra<sup>®</sup> miniMAX CRI90+ white — the 24V remarkable LED system designed to deliver incredibly uniform light to architectural features and delineation applications, installs easily and features OptiLens™ X and CRI90+ to ensure efficient operations.

## With Powerful OptiLens™

**Tetra® miniMAX** features OptiLens™ X, our patented technology that allows for an incredible 175° viewing angle.

## Best-in-Class Loading

Now load up to 118.5 feet (36.1 m) or 237 modules of 24V **Tetra® miniMAX** per 100W power supply using our new and improved GLX2 power supplies.

## Improved Stroke Spacing

The new 24V **Tetra® miniMAX** stroke spacing has improved on average by 30%, thanks to the new OptiLens™ X wide beam angle.

## Tetra® miniMAX Features

- Wide 175° beam angle
- CRI90+
- 24 Volt DC, UL Wet Rated & IP66
- 10-year limited warranty



## Tetra® miniMAX Spacing

	Can Depth	Coverage
Medium	1.5-3" (38-76mm)	3-6.5" (76-165mm)
	3-4" (76-102mm)	5-8" (127-203mm)
Large	4-5" (102-127mm)	8-11" (203-279mm)
	5-6" (127-152mm)	13-15" (330-381mm)

# Total Reliability

To ensure every **Tetra® miniMAX CRI90+** installation will operate brilliantly for years, we perform the most extensive, stringent testing in the industry. We test the LED, water and dust ingress protection, sub-system and complete system at our in-house and independent laboratories around the world. Validation of our designs, components, products and processes include high temperature, high humidity and accelerated life testing.



# Mechanical Outline & Viewing Angle

Dimensions in (inches). Metric equivalent mm

Tetra miniMAX 24V whites

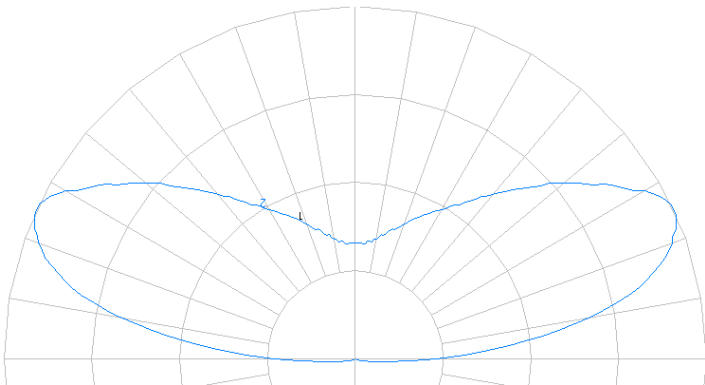
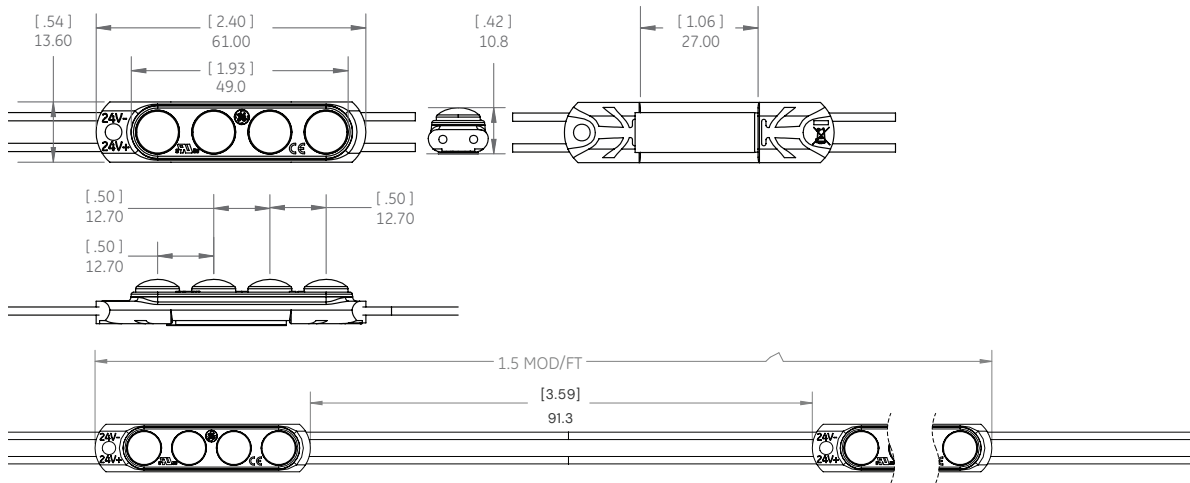

# Components

SKU	Model	Details	Color	Order unit	Pkg. Quantity	Modules per strip
93301725	GEmm <sup>2</sup> 441-WICRI90	Tetra® miniMAX 24V 4100K CRI90	Warm White	Box	5 Strips/Box	40 modules per strip (6 m/strip)
93301726	GEmm <sup>2</sup> 432-WICRI90	Tetra® miniMAX 24V 3200K CRI90	Warm White	Box	5 Strips/Box	40 modules per strip (6 m/strip)
93301727	GEmm <sup>2</sup> 427-WICRI90	Tetra® miniMAX 24V 2700K CRI90	Warm White	Box	5 Strips/Box	40 modules per strip (6 m/strip)

## Technical Specifications

Model	CCT	Typical Brightness* Lumens/module	Typical Brightness* Lumens/m	Energy Consumption* Module Wattage	Energy Consumption* System Wattage	100W GLX Power Supply Loading	100W GLX2/ TT Power Supply Loading	Viewing Angle
GEmm <sup>2</sup> 441-WICRI90	4100K	41	271	0.35w/module	0.41w/module	33.5 m	36.1 m	175°
GEmm <sup>2</sup> 432-WICRI90	3200K	40	264	0.35w/module	0.41w/module	33.5 m	36.1 m	175°
GEmm <sup>2</sup> 427-WICRI90	2700K	37	244	0.34w/module	0.40w/module	33.5 m	36.1 m	175°

\*Typical performance at 25C +/- 10%

## Additional Specifications

	Whites				
<b>Dimmable</b>	Yes (with dimmable power supply)				
<b>LEDs/Module</b>	4				
<b>LEDs/ft (LEDs/m)</b>	8 (26)				
<b>Modules/ ft. (Modules/m)</b>	2 (6.6)				
<b>Module Dimensions (h x l x w)</b>	0.41 in x 2.4 in x 0.54 in (10.46 mm x 61 mm x 13.6 mm)				
<b>Cutting Resolution</b>	Cut on wire between every module				
<b>Power Supply</b>	GEPS24-25-NA Input: 100-305VAC; Output: 24VDC GEPS24D-80U Input: 90-305VAC; Output: 24VDC GEPS24-100U Input: 108-305VAC; Output: 24VDC GEPS24-200U Input: 90-305VAC; Output: 24VDC GEPS24-300U Input: 108-305VAC; Output: 24VDC				
<b>Maximum Supply Wire Limits</b>		<b>18 AWG/0.82 mm<sup>2</sup> Supply Wire</b>	<b>16 AWG/1.31 mm<sup>2</sup> Supply Wire</b>	<b>14 AWG/2.08 mm<sup>2</sup> Supply Wire</b>	<b>12 AWG/3.31 mm<sup>2</sup> Supply Wire</b>
	25W Power Supply	120 ft./36.6 m	/	/	/
	80W Power Supply	20 ft./6.1 m	25 ft./7.6 m	35 ft./10.6 m	40 ft./12.1 m
	100W Power Supply	20 ft./6.1 m	25 ft./7.6 m	35 ft./10.6 m	40 ft./12.1 m
	200W Power Supply	20 ft./6.1 m	25 ft./7.6 m	35 ft./10.6 m	40 ft./12.1 m
300W Power Supply	20 ft./6.1 m	25 ft./7.6 m	35 ft./10.6 m	40 ft./12.1 m	
<b>Operating Environment</b>	-40 °C to +60 °C (-40 °F to +140 °F)				
<b>Warranty</b>	Limited system warranty of up to ten (10) years				
<b>System Certifications</b>	UL Recognized (C-US) #E219167, UL Classified (C-US) #E229508, CE, ROHS • IP66 rated: for dry, damp or wet location.				



GELW4865-1

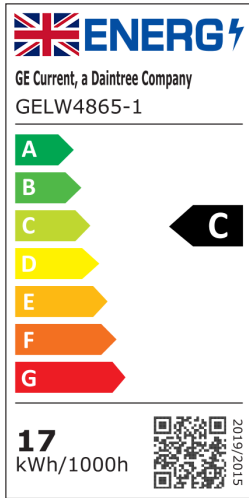
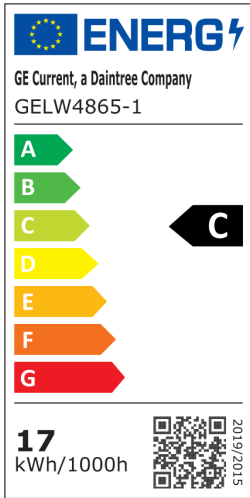

For sign use only. Not intended for general lighting applications.

This product is considered to be a "containing product" with a length nearest to 50 cm being considered the "light source" per Regulations (EU) 2019/2020 and (EU) 2019/2015.

As the final application permits, without permanent damage to the containing product and with the use of commonly available tools; as specified in the install instructions, the contained LED light source may be cut out, removed from the mounting surface, and replaced or dismantled at the end of life, by a professional installer.



Electrical products must not be thrown out with domestic waste. They must be taken to a communal collection point for environmentally friendly disposal in accordance with local regulations. Contact your local authorities or stockist for advice on recycling. The packaging material is recyclable. Dispose of the packaging in an environmentally friendly manner and make it available for the recyclable material collection-service.

GEXNS32-2

GEXNB32-2

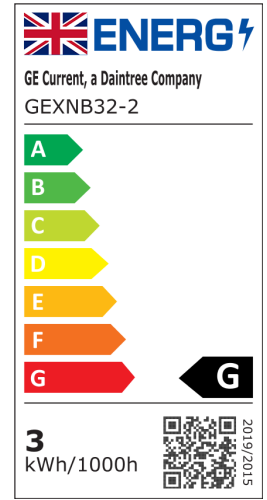
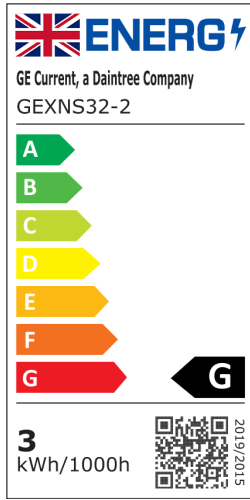
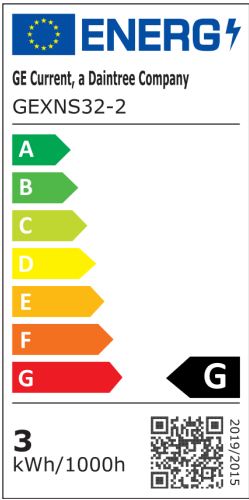

GEXNB65-2

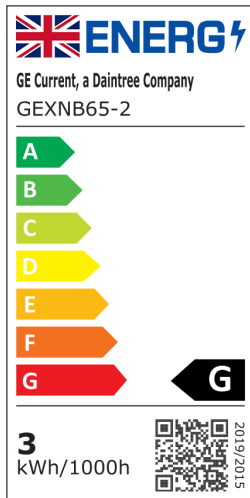
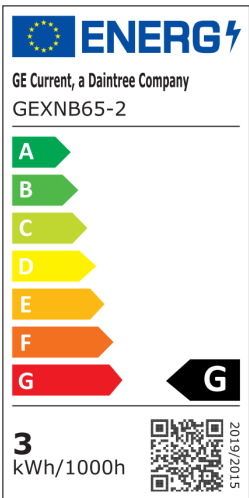

GEXNS65-2

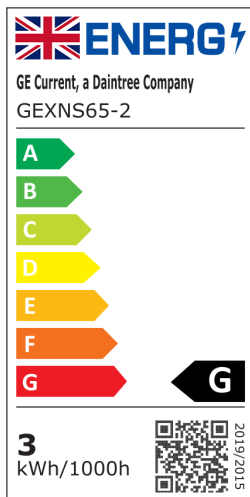
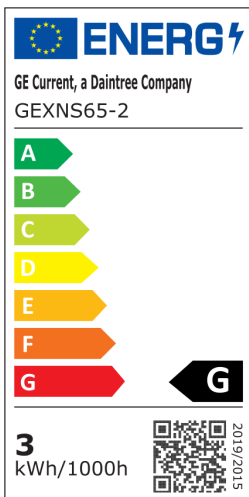

For sign use only. Not intended for general lighting applications.

This product is considered to be a "containing product" with a length nearest to 50 cm being considered the "light source" per Regulations (EU) 2019/2020 and (EU) 2019/2015.

As the final application permits, without permanent damage to the containing product and with the use of commonly available tools; as specified in the install instructions, the contained LED light source may be cut out, removed from the mounting surface, and replaced or dismantled at the end of life, by a professional installer.



Electrical products must not be thrown out with domestic waste. They must be taken to a communal collection point for environmentally friendly disposal in accordance with local regulations. Contact your local authorities or stockist for advice on recycling. The packaging material is recyclable. Dispose of the packaging in an environmentally friendly manner and make it available for the recyclable material collection-service.

## GEXNFS65-1

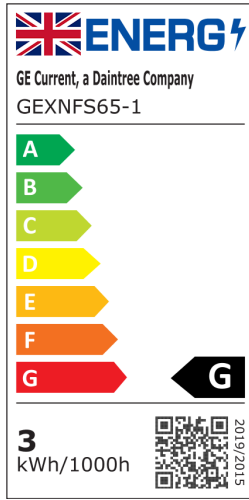
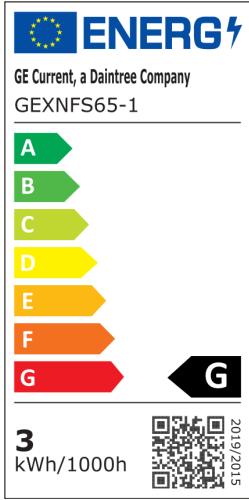

## GEXNFS32-1

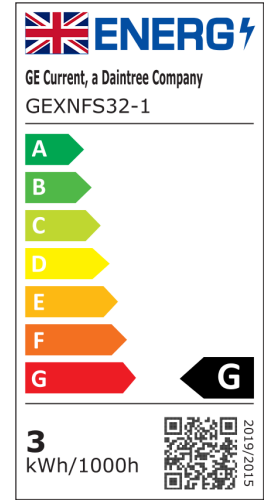

For sign use only. Not intended for general lighting applications.

This product is considered to be a "containing product" with a length nearest to 50 cm being considered the "light source" per Regulations (EU) 2019/2020 and (EU) 2019/2015.

As the final application permits, without permanent damage to the containing product and with the use of commonly available tools; as specified in the install instructions, the contained LED light source may be cut out, removed from the mounting surface, and replaced or dismantled at the end of life, by a professional installer.



Electrical products must not be thrown out with domestic waste. They must be taken to a communal collection point for environmentally friendly disposal in accordance with local regulations. Contact your local authorities or stockist for advice on recycling. The packaging material is recyclable. Dispose of the packaging in an environmentally friendly manner and make it available for the recyclable material collection-service.



## GEBI71-S2

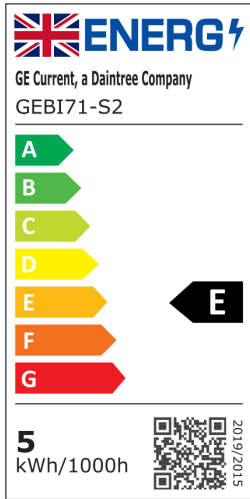
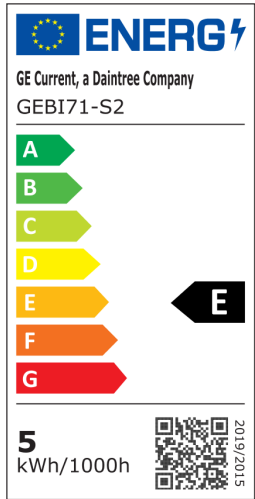

## GEBI65-S2

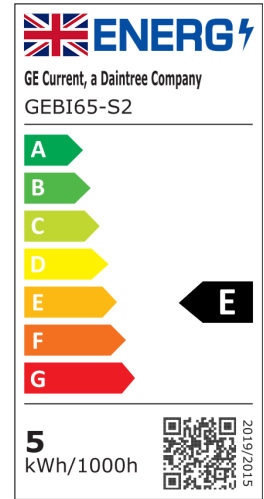

## GEBI57-S2

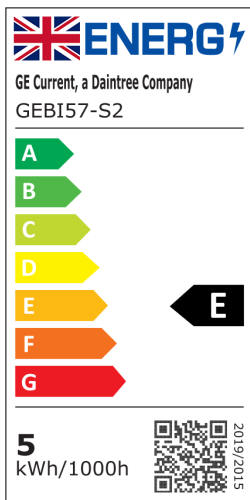
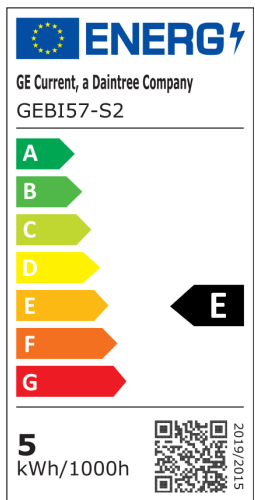

## GEBI50-S2

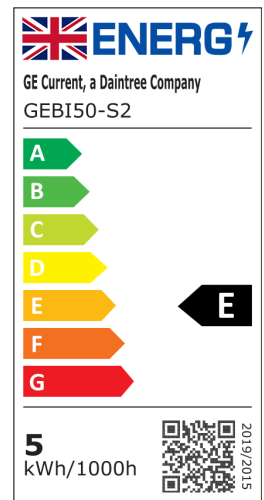
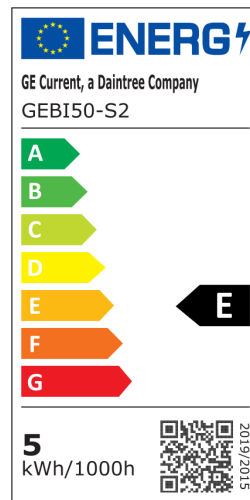

## GEBI41-S2

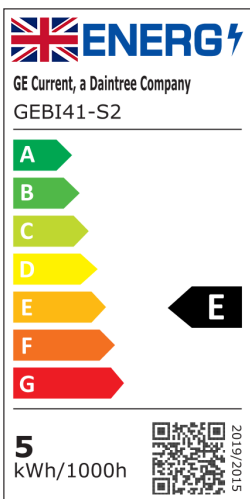
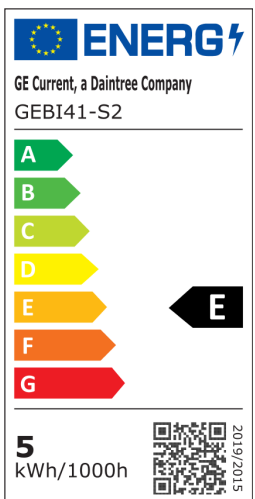

## GEBI32-S2

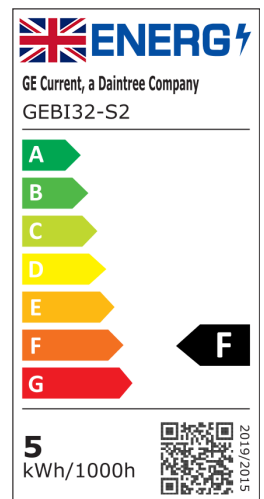
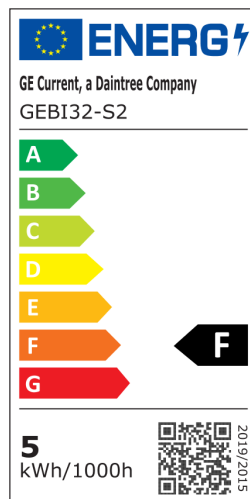

For sign use only. Not intended for general lighting applications.

This product is considered to be a "containing product" with a length nearest to 50 cm being considered the "light source" per Regulations (EU) 2019/2020 and (EU) 2019/2015.

As the final application permits, without permanent damage to the containing product and with the use of commonly available tools; as specified in the install instructions, the contained LED light source may be cut out, removed from the mounting surface, and replaced or dismantled at the end of life, by a professional installer.

 Electrical products must not be thrown out with domestic waste. They must be taken to a communal collection point for environmentally friendly disposal in accordance with local regulations. Contact your local authorities or stockist for advice on recycling. The packaging material is recyclable. Dispose of the packaging in an environmentally friendly manner and make it available for the recyclable material collection-service.

GEmm<sup>2</sup>441-W1CRI90

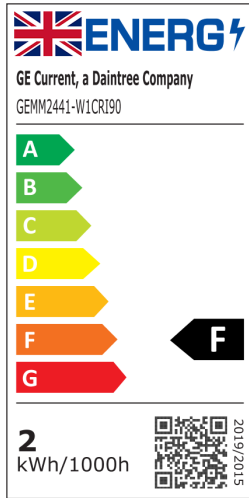
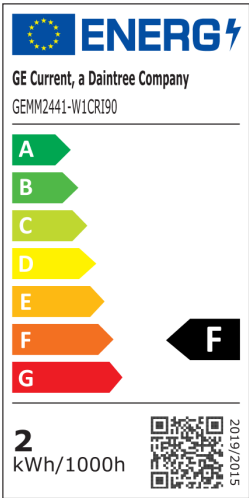

GEmm<sup>2</sup>432-W1CRI90

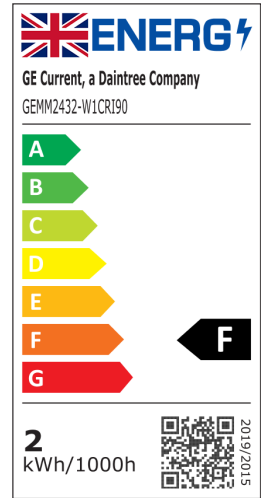
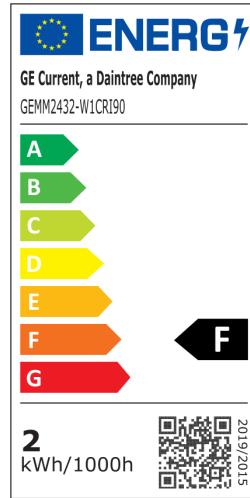

GEmm<sup>2</sup>427-W1CRI90

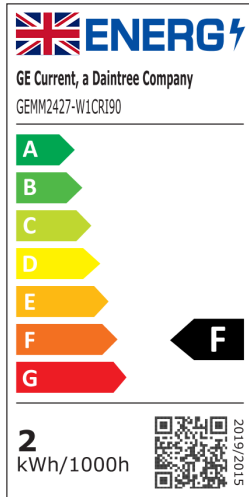
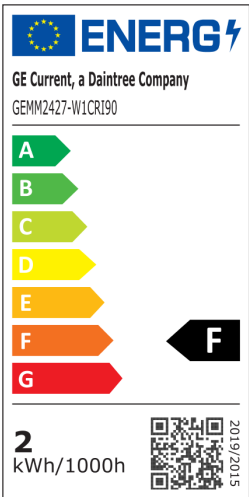

This product is considered to be a "containing product" with a length nearest to 50 cm being considered the "light source" per Regulations (EU) 2019/2020 and (EU) 2019/2015.

As the final application permits, without permanent damage to the containing product and with the use of commonly available tools; as specified in the install instructions, the contained LED light source may be cut out, removed from the mounting surface, and replaced or dismantled at the end of life, by a professional installer.

Electrical products must not be thrown out with domestic waste. They must be taken to a communal collection point for environmentally friendly disposal in accordance with local regulations. Contact your local authorities or stockist for advice on recycling. The packaging material is recyclable. Dispose of the packaging in an environmentally friendly manner and make it available for the recyclable material collection-service.







# Batten LED Luminaire

CANOPY LIGHTING SYSTEMS

Utility lighting for canopies,  
awnings and drive-thrus

The Batten LED Luminaire delivers brilliant performance in tight, demanding situations where utilitarian light is required. The Batten is suitable for mounting in any ambient application space and its unique design makes it ideal to mount individually or run in a continuous row. We've improved run lengths in the all-new second generation – now up to 172 ft per leader cable!

## More lighting performance

- Maximizes coverage through wide, uniform Lambertian light distribution
- Extruded plastic design protects against moisture, dust and damage
- No decrease of light output in cold settings—as can happen with fluorescent
- Can be used in  $-40^{\circ}\text{C}$  to  $60^{\circ}\text{C}$  ( $-40^{\circ}\text{F}$  to  $140^{\circ}\text{F}$ )
- Comes in Regular and High Output
- 50,000-hour rated life
- Color Temperatures: 7100K, 5000K, 4000K, 3500K, 3000K, Red & Blue
- Sizes: 1ft (white only), 2ft, 4ft, 8ft

## More savings on installation and operation

- Installation is fast and easy with mounting clips
- Integrated power supply eliminates separate drivers
- Easily daisy chain (jumper wire & end-to-end)
- Input Voltage: 120–277V
- Wet Rated
- IP66 Tested

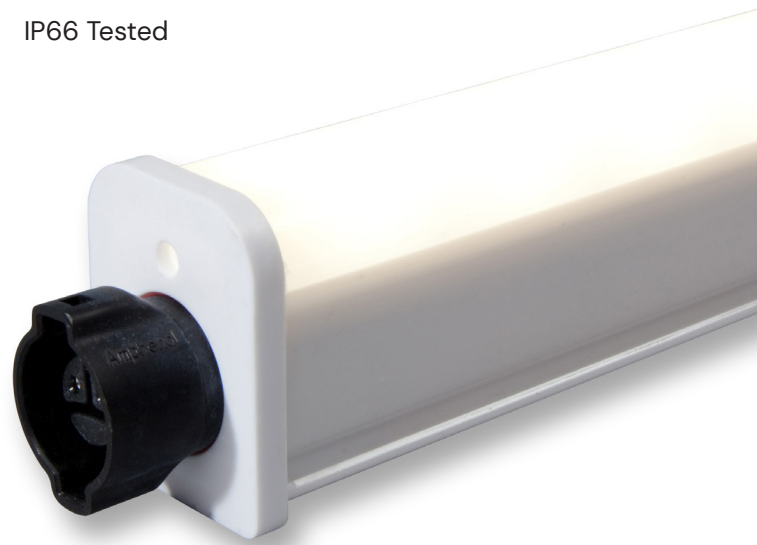

## Tip

Identify the second generation Batten by its removable yellow end cap



## Total Reliability

To ensure every Batten installation will operate brilliantly for years, we perform the most extensive, stringent testing in the industry. We test the LED, water and dust ingress protection, sub-system and complete system at our in-house and independent laboratories around the world. Validation of our designs, components, products and processes include high temperature, high humidity and accelerated life testing.



## Accessories

SKU	Description	Long Description	Package Quantity
93113059	GERBL-O2FP-10-LC72IN	6ft Leader Cable	1 Leader Cable per bag
93113060	GERBL-O2MG-10-LC24IN	2ft Jumper Cable	1 Jumper Cable per bag
88818	Wet Clip-Std	Standard Mounting Clip	12 clips per bag
10734	Wet Clip-Slim	Slim Mounting Clip	12 clips per bag
93113061	Metal clip	Metal Mounting Clips	12 clips per bag

Specification Item	Specification
Packaging Qty	4 per box
Applications	Canopies, awnings, drive-thrus
Operating Environment	-40 °C to +60 °C (-40 °F to +140 °F)
Voltage	120 - 277 VAC
Warranty	Limited system warranty of up to five (5) years
System Certifications	UL Classified #E320967, 24", 48", and 96" products are CSA sanitation certified

## Components

### Regular output

SKU	Description	Long Description
93024679	GEWM1235BAT	12" 3500K LED Fixtures
82349	GEWM2430BAT	24" 3000K LED Fixtures
93027304	GEWM2435BAT	24" 3500K LED Fixtures
82351	GEWM2440BAT	24" 4000K LED Fixtures
82355	GEWM2450BAT	24" 5000K LED Fixtures
82356	GEWM2471BAT	24" 7100K LED Fixtures
93116586	GEWM4830BAT-2	48" 3000K LED Fixtures
93116587	GEWM4835BAT-2	48" 3500K LED Fixtures

### Regular output

SKU	Description	Long Description
93116588	GEWM4840BAT-2	48" 4000K LED Fixtures
93116589	GEWM4850BAT-2	48" 5000K LED Fixtures
93116590	GEWM4871BAT-2	48" 7100K LED Fixtures
93116591	GEWM9630BAT-2	96" 3000K LED Fixtures
93116592	GEWM9640BAT-2	96" 4000K LED Fixtures
93116593	GEWM9650BAT-2	96" 5000K LED Fixtures
93116594	GEWM9671BAT-2	96" 7100K LED Fixtures

# Components

## High output

SKU	Description	Long Description
93024680	GEWH1235BAT	12" 3500K LED Fixtures-HO
82446	GEWH2430BAT	24" 3000K LED Fixtures- HO
82461	GEWH2440BAT	24" 4000K LED Fixtures- HO
82521	GEWH2450BAT	24" 5000K LED Fixtures-HO
82536	GEWH2471BAT	24" 7100K LED Fixtures-HO
93025127	GEWH24BLBAT	24" Blue HO LED Fixtures-HO
93025123	GEWH24RDBAT	24" Red HO LED Fixtures-HO
93116595	GEWH4830BAT-2	48" 3000K LED Fixtures-HO
93116596	GEWH4835BAT-2	48" 3500K HO LED Fixtures-HO
93116597	GEWH4840BAT-2	48" 4000K LED Fixtures-HO

## High output

SKU	Description	Long Description
93116598	GEWH4850BAT-2	48" 5000K LED Fixtures-HO
93116599	GEWH4871BAT-2	48" 7100K LED Fixtures-HO
93116600	GEWH48BLBAT-2	48" Blue HO LED Fixtures-HO
93116601	GEWH48RDBAT-2	48" Red HO LED Fixtures-HO
93116602	GEWH9630BAT-2	96" 3000K LED Fixtures-HO
93116603	GEWH9640BAT-2	96" 4000K LED Fixtures-HO
93116604	GEWH9650BAT-2	96" 5000K LED Fixtures-HO
93116605	GEWH9671BAT-2	96" 7100K LED Fixtures-HO
93116606	GEWH96RDBAT-2	96" Red HO LED Fixtures-HO
93116607	GEWH96BLBAT-2	96" Blue HO LED Fixtures-HO

# Technical Specifications

Specification Item	Color Temperature	Lumens Per Fixture (Typical)	Input Current (AMPs/fixture) @120V	Energy Consumption (System/Module)	Maximum Run Length @120V	Dimensions
<b>Batten LED Luminaire 1ft</b>	3500K	483	0.040	6.00	40ft/12 meters	12.6 x 1.31 x 1.84
<b>Batten LED Luminaire 2ft</b>	3000K	880	0.08	9.00	40ft/12 meters	24.7 x 1.31 x 1.84
	3500K	894				
	4000K	925				
	5000K	965				
	7100K	1010				
<b>Batten LED Luminaire 4ft</b>	3000K	1735	0.15	18.00	92ft/28 meters	46.7 x 1.31 x 1.84
	3500K	1788				
	4000K	1825				
	5000K	1900				
	7100K	1990				
<b>Batten LED Luminaire 8ft</b>	3000K	3420	0.30	36.00	88ft/27 meters	90.9 x 1.31 x 1.84
	4000K	3595				
	5000K	3750				
	7100K	3925				
<b>Batten LED Luminaire 1ft-High Output</b>	3500K	821	0.070	9.00	30ft/9 meters	12.6 x 1.31 x 1.84
<b>Batten LED Luminaire 2ft-High Output</b>	3000K	1425	0.135	16.00	30ft/9 meters	24.7 x 1.31 x 1.84
	4000K	1500				
	5000K	1565				
	7100K	1635				
<b>Batten LED Luminaire 4ft-High Output</b>	3000K	2825	0.24	32.00	56ft/17 meters	46.7 x 1.31 x 1.84
	3500K	2897				
	4000K	2970				
	5000K	3100				
<b>Batten LED Luminaire 8ft-High Output</b>	3000K	5600	0.48	64.00	56ft/17 meters	90.9 x 1.31 x 1.8
	4000K	5890				
	5000K	6140				
	7100K	6430				
<b>Batten LED Luminaire 2ft - HO Red</b>	625nm	349	0.065	8.00	56ft/17 meters	24.7 x 1.31 x 1.84
<b>Batten LED Luminaire 4ft - HO Red</b>	625nm	667	0.125	16.00	56ft/17 meters	46.7 x 1.31 x 1.84
<b>Batten LED Luminaire 8ft - HO Red</b>	625nm	1334	0.270	32.00	56ft/17 meters	90.9 x 1.31 x 1.84
<b>Batten LED Luminaire 2ft - HO Blue</b>	467nm	180	0.08	9.00	56ft/17 meters	24.7 x 1.31 x 1.84
<b>Batten LED Luminaire 4ft - HO Blue</b>	467nm	334	0.15	18.00	56ft/17 meters	46.7 x 1.31 x 1.84
<b>Batten LED Luminaire 8ft - HO Blue</b>	467nm	688	0.300	36.00	56ft/17 meters	90.9 x 1.31 x 1.84



Your **LIFESTYLE FURNITURE** Store

# Tetra<sup>®</sup> Stick

CABINET SIGN LIGHTING SYSTEMS

Stick with the brand  
you can trust

**Tetra<sup>®</sup> Stick** takes all the advantages of our 24V LED channel letter modules, and brings them to cabinet signs in an easily-installed system. The **Tetra<sup>®</sup> Stick** fits directly into existing sockets and requires fewer power supplies than competitors' offerings, thanks to its best-in-class loading, greatly reducing material, installation and energy costs.

## Powerful OptiLens™ X

Tetra® Stick features OptiLens™ X, our patented technology that allows for an incredible 170° viewing angle. This exclusive technology redirects otherwise wasted light to the sign face, making sure your signs shine.

## Best-in-class loading

The 24V Tetra® Stick loads to an impressive five 84" double-sided sticks per 100W power supply.

## Improved stroke spacing and installation

The new 24V Tetra® Stick stroke spacing is impressive, requiring less product, thanks to the new OptiLens™ X wide beam angle and increased light output. Tetra® Stick is available in two end wire lengths, making installation a snap and allowing customers to customize their products to their needs.

## Total Reliability

To ensure every Tetra® Stick installation will operate brilliantly for years, we perform the most extensive, stringent testing in the industry. We test the LED, water and dust ingress protection, sub-system and complete system at our in-house and independent laboratories around the world. Validation of our designs, components, products and processes include high temperature, high humidity and accelerated life testing.



## Tetra® Stick Features

- Available with PowerMAX or PowerMAX HO modules
- Wide 170° beam angle
- Efficacy: 156 lm/W (PowerMAX)  
50 lm/W (PowerMAX HO)
- 24 Volt DC, Class 2 (UL), Class III (IEC)
- UL Dry or Damp Rated
- 10-year limited warranty

## Recommended Spacing

	Depth from Stick to Face	Recommended Spacing
<b>Tetra® Stick single-sided PowerMAX and PowerMAX HO</b>	5" (127 mm)	12" (305 mm)
	6" (152 mm)	14" (356 mm)
	7" (178 mm)	16" (406 mm)
	≥ 8-12" (203-305 mm)	18" (457 mm)

For full spacing guidelines, please see page 65

## Accessories

SKU	Description	Package Quantity
93020091	LFL-LED Sockets	6 sets per box (12 total)

# Nomenclature

With 114 different product options to choose from, you can easily customize your Tetra® Stick to perfectly fit your application. To make sure you order the right product the first time, please create your own personal product using the below product code tables:

GETS	--	--	---	71	--	1
Product Identifier	Module Type	Configuration	T-12 Length	Color Temperature	Whip Length	Product Generation
GETS	PM = PowerMAX	SS = Single Sided	018 = 18" T-12	71 = 7100K	A = 3'	1 = GenI
	PH = PowerMAX HO	DS = Double Sided	024 = 24" T-12		B = 6'	
			030 = 30" T-12			
			036 = 36" T-12			
			042 = 42" T-12			
			048 = 48" T-12			
			060 = 60" T-12			
			064 = 64" T-12			
			072 = 72" T-12			
			084 = 84" T-12			
			096 = 96" T-12			
			108 = 108" T-12			
			117 = 117" T-12			
			120 = 120" T-12			

## Specifications – Single Sided PowerMAX

"T12 Length (in)"	"Actual Length (in)"	Modules per Stick	Lumens per Stick	Watts per Stick	Sticks per 100W GLX Power Supply	"Sticks per 100W GLX2 Power Supply"	Whip Length	Part Number
18	15.91	2	266	1.7	47	51	3 ft / 6 ft	GETSPMSSO1871A1 / GETSPMSSO1871B1
24	21.91	3	399	2.5	32	34	3 ft / 6 ft	GETSPMSSO2471A1 / GETSPMSSO2471B1
30	27.91	3	399	2.5	32	34	3 ft / 6 ft	GETSPMSSO3071A1 / GETSPMSSO3071B1
36	33.91	4	532	3.4	24	25	3 ft / 6 ft	GETSPMSSO3671A1 / GETSPMSSO3671B1
42	39.91	5	665	4.2	19	20	3 ft / 6 ft	GETSPMSSO4271A1 / GETSPMSSO4271B1
48	45.91	6	798	5.0	16	17	3 ft / 6 ft	GETSPMSSO4871A1 / GETSPMSSO4871B1
60	57.91	7	931	5.9	14	14	3 ft / 6 ft	GETSPMSSO6071A1 / GETSPMSSO6071B1
64	61.91	8	1,064	6.7	12	12	3 ft / 6 ft	GETSPMSSO6471A1 / GETSPMSSO6471B1
72	69.91	9	1,197	7.6	11	11	3 ft / 6 ft	GETSPMSSO7271A1 / GETSPMSSO7271B1
84	81.91	10	1,330	8.4	10	10	3 ft / 6 ft	GETSPMSSO8471A1 / GETSPMSSO8471B1
96	93.91	12	1,596	10.1	8	8	3 ft / 6 ft	GETSPMSSO9671A1 / GETSPMSSO9671B1
108	105.91	13	1,729	10.9	7	7	3 ft / 6 ft	GETSPMSS10871A1 / GETSPMSS10871B1
117	114.91	14	1,862	11.8	7	7	3 ft / 6 ft	GETSPMSS11771A1 / GETSPMSS11771B1
120	117.91	15	1,995	12.6	6	6	3 ft / 6 ft	GETSPMSS12071A1 / GETSPMSS12071B1

## Specifications – Double Sided PowerMAX

"T12 Length (in)"	"Actual Length (in)"	Modules per Stick	Lumens per Stick	Watts per Stick	Sticks per 100W GLX Power Supply	"Sticks per 100W GLX2 Power Supply"	Whip Length	Part Number
18	15.91	4	532	3.4	24	25	3 ft / 6 ft	GETSPMDSO1871A1 / GETSPMDSO1871B1
24	21.91	6	798	5.0	16	17	3 ft / 6 ft	GETSPMDSO2471A1 / GETSPMDSO2471B1
30	27.91	6	798	5.0	16	17	3 ft / 6 ft	GETSPMDSO3071A1 / GETSPMDSO3071B1
36	33.91	8	1,064	6.8	12	12	3 ft / 6 ft	GETSPMDSO3671A1 / GETSPMDSO3671B1
42	39.91	10	1,330	8.4	10	10	3 ft / 6 ft	GETSPMDSO4271A1 / GETSPMDSO4271B1
48	45.91	12	1,596	10.0	8	8	3 ft / 6 ft	GETSPMDSO4871A1 / GETSPMDSO4871B1
60	57.91	14	1,862	11.8	7	7	3 ft / 6 ft	GETSPMDSO6071A1 / GETSPMDSO6071B1
64	61.91	16	2,128	13.4	6	6	3 ft / 6 ft	GETSPMDSO6471A1 / GETSPMDSO6471B1
72	69.91	18	2,394	15.2	5	5	3 ft / 6 ft	GETSPMDSO7271A1 / GETSPMDSO7271B1
84	81.91	20	2,660	16.8	5	5	3 ft / 6 ft	GETSPMDSO8471A1 / GETSPMDSO8471B1
96	93.91	24	3,192	20.2	4	4	3 ft / 6 ft	GETSPMDSO9671A1 / GETSPMDSO9671B1
108	105.91	26	3,458	21.8	3	3	3 ft / 6 ft	GETSPMDS10871A1 / GETSPMDS10871B1
117	114.91	28	3,724	23.6	3	3	3 ft / 6 ft	GETSPMDS11771A1 / GETSPMDS11771B1
120	117.91	30	3,990	25.2	3	3	3 ft / 6 ft	GETSPMDS12071A1 / GETSPMDS12071B1

## Specifications – Single Sided PowerMAX HO

"T12 Length (in)"	"Actual Length (in)"	Modules per Stick	Lumens per Stick	Watts per Stick	Sticks per 100W GLX Power Supply	"Sticks per 100W GLX2 Power Supply"	Whip Length	Part Number
18	15.91	2	360	2.4	33	36	3 ft / 6 ft	GETSPHSS01871A1 / GETSPHSS01871B1
24	21.91	3	540	3.6	22	24	3 ft / 6 ft	GETSPHSS02471A1 / GETSPHSS02471B1
30	27.91	3	540	3.6	22	24	3 ft / 6 ft	GETSPHSS03071A1 / GETSPHSS03071B1
36	33.91	4	720	4.8	16	18	3 ft / 6 ft	GETSPHSS03671A1 / GETSPHSS03671B1
42	39.91	5	900	6.0	13	14	3 ft / 6 ft	GETSPHSS04271A1 / GETSPHSS04271B1
48	45.91	6	1,080	7.2	11	12	3 ft / 6 ft	GETSPHSS04871A1 / GETSPHSS04871B1
60	57.91	7	1,260	8.4	9	10	3 ft / 6 ft	GETSPHSS06071A1 / GETSPHSS06071B1
64	61.91	8	1,440	9.6	8	9	3 ft / 6 ft	GETSPHSS06471A1 / GETSPHSS06471B1
72	69.91	9	1,620	10.8	7	8	3 ft / 6 ft	GETSPHSS07271A1 / GETSPHSS07271B1
84	81.91	10	1,800	12.0	7	7	3 ft / 6 ft	GETSPHSS08471A1 / GETSPHSS08471B1
96	93.91	12	2,160	14.4	6	6	3 ft / 6 ft	GETSPHSS09671A1 / GETSPHSS09671B1
108	105.91	13	2,340	15.6	5	5	3 ft / 6 ft	GETSPHSS10871A1 / GETSPHSS10871B1
117	114.91	14	2,520	16.8	5	5	3 ft / 6 ft	GETSPHSS11771A1 / GETSPHSS11771B1
120	117.91	15	2,700	18.0	4	4	3 ft / 6 ft	GETSPHSS12071A1 / GETSPHSS12071B1

## Specifications – Single Sided PowerMAX HO

"T12 Length (in)"	"Actual Length (in)"	Modules per Stick	Lumens per Stick	Watts per Stick	Sticks per 100W GLX Power Supply	"Sticks per 100W GLX2 Power Supply"	Whip Length	Part Number
18	15.91	4	720	4.8	16	18	3 ft / 6 ft	GETSPHDS01871A1 / GETSPHDS01871B1
24	21.91	6	1,080	7.2	11	12	3 ft / 6 ft	GETSPHDS02471A1 / GETSPHDS02471B1
30	27.91	6	1,080	7.2	11	12	3 ft / 6 ft	GETSPHDS03071A1 / GETSPHDS03071B1
36	33.91	8	1,440	9.6	8	9	3 ft / 6 ft	GETSPHDS03671A1 / GETSPHDS03671B1
42	39.91	10	1,800	12.0	7	7	3 ft / 6 ft	GETSPHDS04271A1 / GETSPHDS04271B1
48	45.91	12	2,160	14.4	5	6	3 ft / 6 ft	GETSPHDS04871A1 / GETSPHDS04871B1
60	57.91	14	2,520	16.8	5	5	3 ft / 6 ft	GETSPHDS06071A1 / GETSPHDS06071B1
64	61.91	16	2,880	19.2	4	4	3 ft / 6 ft	GETSPHDS06471A1 / GETSPHDS06471B1
72	69.91	18	3,240	21.6	4	4	3 ft / 6 ft	GETSPHDS07271A1 / GETSPHDS07271B1
84	81.91	20	3,600	24.0	3	3	3 ft / 6 ft	GETSPHDS08471A1 / GETSPHDS08471B1
96	93.91	24	4,320	28.8	3	3	3 ft / 6 ft	GETSPHDS09671A1 / GETSPHDS09671B1
108	105.91	26	4,680	31.2	2	2	3 ft / 6 ft	GETSPHDS10871A1 / GETSPHDS10871B1
117	114.91	28	5,040	33.6	2	2	3 ft / 6 ft	GETSPHDS11771A1 / GETSPHDS11771B1
120	117.91	30	5,400	36.0	2	2	3 ft / 6 ft	GETSPHDS12071A1 / GETSPHDS12071B1

## Additional Specifications

<b>Dimmable</b>	Yes (with dimmable power supply)				
<b>Quantity per Box</b>	5				
<b>Cutting Resolution</b>	Cut on wire between every module				
<b>Power Supply</b>	GEPS24-25-NA Input: 100-305VAC; Output: 24VDC GEPS24D-80U Input: 90-305VAC; Output: 24VDC GEPS24-100U Input: 108-305VAC; Output: 24VDC GEPS24-200U Input: 90-305VAC; Output: 24VDC GEPS24-300U Input: 108-305VAC; Output: 24VDC				
<b>Maximum Supply Wire Limits</b>		<b>"18 AWG/0.82 mm<sup>2</sup> Supply Wire"</b>	<b>"16 AWG/1.31 mm<sup>2</sup> Supply Wire"</b>	<b>"14 AWG/2.08 mm<sup>2</sup> Supply Wire"</b>	<b>"12 AWG/3.31 mm<sup>2</sup> Supply Wire"</b>
	25W Power Supply	120 ft./36.6 m	-	-	-
	80W Power Supply	20 ft./6.1 m	25 ft./7.6 m	35 ft./10.6 m	40 ft./12.1 m
	100W Power Supply	20 ft./6.1 m	25 ft./7.6 m	35 ft./10.6 m	40 ft./12.1 m
	180W Power Supply	20 ft./6.1 m	25 ft./7.6 m	35 ft./10.6 m	40 ft./12.1 m
300W Power Supply	20 ft./6.1 m	25 ft./7.6 m	35 ft./10.6 m	40 ft./12.1 m	
<b>Operating Environment</b>	-40 °C to +60 °C (-40 °F to +140 °F)				
<b>Warranty</b>	Limited system warranty of up to ten (10) years				
<b>System Certifications</b>	UL Recognized (C-US) #E219167, UL Classified (C-US) #E229508, CE, ROHS for dry or damp location.				





# Tetra<sup>®</sup> EdgeLine

CANOPY LIGHTING SYSTEMS

Slim wall wash fixture for  
canopies and awnings

Tetra EdgeLine delivers brilliant performance in wall wash and canopy lighting applications. The EdgeLine's slim form factor is suitable for mounting in tight application spaces, and its symmetric optical design evenly distributes bright light exactly where you need it.

## Tetra® EdgeLine Features

- Maximizes coverage through wide, uniform symmetric light distribution, with no scalloping
- Extruded plastic design protects against moisture, dust and damage
- Functions in hot and cold climates: -40°C to 60°C (-40°F to 140°F)
- 50,000-hour rated life
- Field cuttable every 3 in (75 mm) for custom sizes with no waste
- Color Temperature: 6500K
- Size: 4 ft (1.2 m)

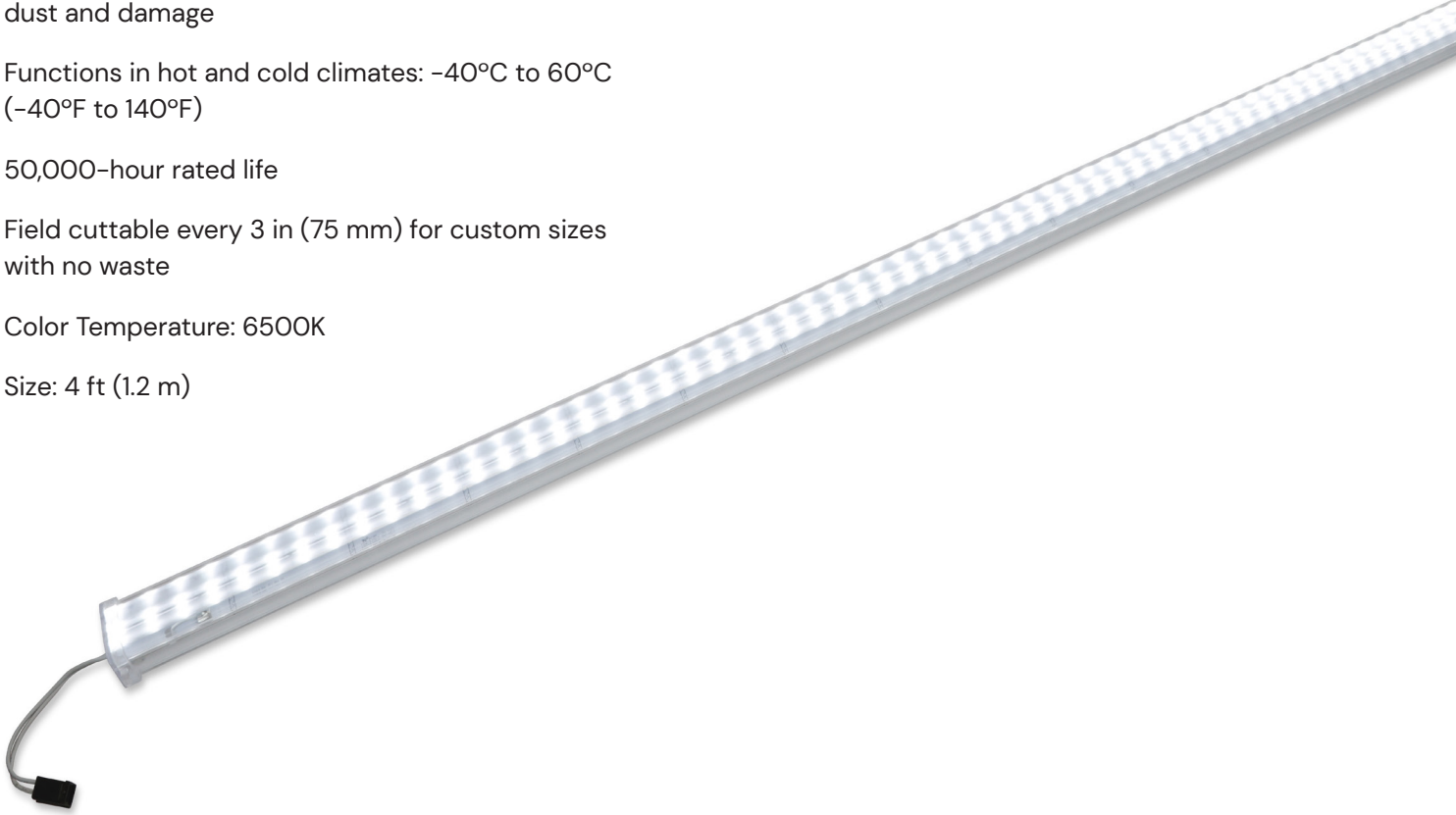

## Tetra® EdgeLine Specifications

- Wide, symmetric beam angle
- Efficacy: 156 lm/W
- 24 Volt DC, Class 2 (UL), Class III (IEC)
- IP66 and Damp rated
- 10-year limited warranty

## Total Reliability

To ensure every Tetra® EdgeLine installation will operate brilliantly for years, we perform the most extensive, stringent testing in the industry. We test the LED, water and dust ingress protection, sub-system and complete system at our in-house and independent laboratories around the world. Validation of our designs, components, products and processes include high temperature, high humidity and accelerated life testing.



## Mechanical Outline

Dimensions in (inches). Metric equivalent in m and mm

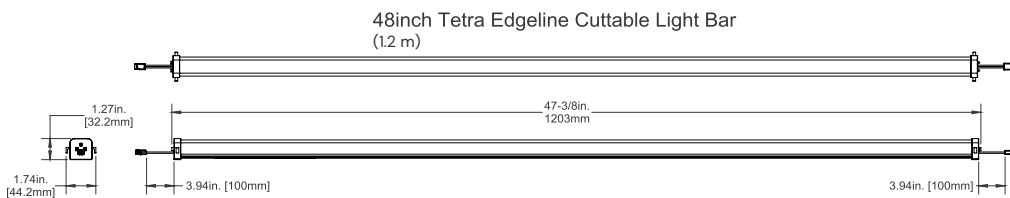

### Slim Straight Bracket

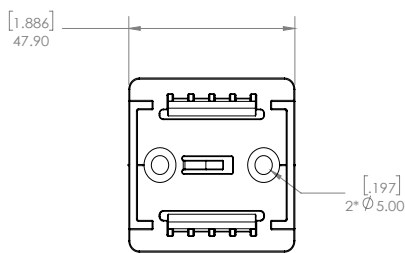

### Straight Bracket

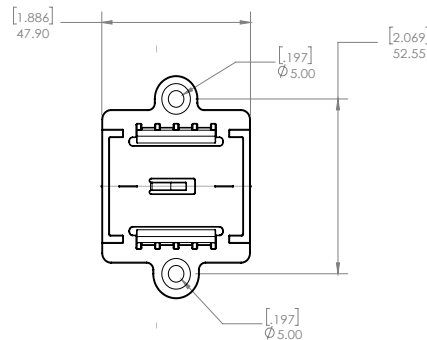

### Sealed Connector Cover

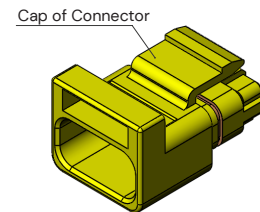

## Accessories

SKU	Model Number	Description	Package Quantity
88818	Wet Clip-Std	Standard Mounting Clip	12 clips per bag
10734	Wet Clip-Slim	Slim Mounting Clip	12 clips per bag
93155837	Sealed Cap and gasket	Sealed cap and gasket for field cuts	20
93155838	Sealed Connector Cover	Cover to terminate the connector	50
93155625	GE-JC24IN-66M-66F	Jumper cable to add cable length between bars	50
93155627	GE-LC24IN-66F	24" (609 mm) leader cable with IP66 female connector	50
93155628	GE-LC24IN-66M	24" (609 mm) leader cable with IP66 male connector	50

# Components

SKU	Model	Details	Color	Quantity
93155556	GELW4865-1	48" (1.2 m) Cuttable Wall Wash Linear Bar	White	10 bars per box
93155555	GELW1265-1	12" Cuttable Wall Wash Linear Bar	White	10 PCS/Box

## Technical Specifications

Model	CCT	Typical Brightness* Lumens/bar	Typical Wattage* (W)	25W Power Supply	60W Power Supply	100W GLX Power Supply	200W GLX Power Supply	300W GLX Power Supply	Maximum light bars in series connection (s)
GELW4865-1	6500K	2600	16.7	1 bar/ 4 ft. (1.2 m)	3 bars/ 12 ft. 10-1/8 in. (3.6m)	5 bars/ 19 ft. 9 in. (6 m)	5 bars/ 19 ft. 9 in. (6 m) per bank 10 bars/ 39 ft. 6 in. (12 m) per PS	5 bars/ 19 ft. 9 in. (6 m) per bank 15 bars/ 59 ft. 3 in. (18 m) per PS	3 bars/ 11 ft. 10-1/8 in. (3.6 m)
GELW1265-1	6500K	2600	16.7	5 bars/ 5ft. (1.53 m)	16 bars/16ft. (4.88 m)	20 bars/ 20 ft. (6.10 m)	20 bars/ 20ft. (6.10 m) per bank 40 bars/ 40ft. (12.20 m) per PS	20 bars/ 20ft. (6.10 m) per bank 60 bars/ 60ft. (18.30 m) per PS	11 bars / 11 ft. (3.35 m)

\*Typical performance at 25C +/- 10%

## Additional Specifications

Specification	Specification
Voltage	24VDC
Cutting Resolution	Can be cut every 3 inches (75 mm)
Dimmable	Yes (with dimmable power supply)
Power Supply	GESPS24-25U Input: 100-305VAC; Output: 24VDC GEPS24D-60U Input: 120-277VAC; Output: 24VDC GEPS24-100U Input: 108-305VAC; Output: 24VDC GEPS24-200U Input: 90-305VAC; Output: 24VDC GEPS24-300U Input: 108-305VAC; Output: 24VDC
Maximum Remote Mounting Distance	18 AWG/0.82 mm <sup>2</sup> Supply Wire
	16 AWG/1.31 mm <sup>2</sup> Supply Wire
	14 AWG/2.08 mm <sup>2</sup> Supply Wire
	12 AWG/3.31 mm <sup>2</sup> Supply Wire
25W Power Supply	66 ft./20.1 m
60W Power Supply	5 ft./1.5 m
100W Power Supply	5 ft./1.5 m
200W Power Supply	5 ft./1.5 m
300W Power Supply	5 ft./1.5 m
Operating Environment	-40 °C to +60 °C (-40 °F to +140 °F)
Dimensions (L x W x H)	47.37" x 1.74" x 1.27" (1203 mm x 44.2 mm x 32.2 mm)
Warranty	Current offers a limited system warranty of up to ten (10) years
System Certifications	UKCA, UL Recognized (c-us) #E219167, UL Certified Retrofit Sign Conversion Kit (c-us) #E229508, CE, ROHS, IP66, UL Damp Rated

