

# Lumination® Linear In-Bay Lighting (LIB)



## BEFORE YOU BEGIN

Read these instructions completely and carefully.

### WARNING / AVERTISSEMENT

#### RISK OF FIRE OR ELECTRIC SHOCK

- Turn power off before inspection, installation or removal.
- Installation requires a person familiar with the construction and operation of the luminaire's electrical system and the hazard involved. If not qualified, do not attempt installation. Contact a qualified electrician.
- To prevent wiring damage or abrasion, do not expose wiring to edges of sheet metal or other sharp objects.
- Follow all NEC and local codes.

#### RISQUES D'INCENDIE OU DE DECHARGES ELECTRIQUES

- Coupez l'alimentation avant d'inspecter, installer ou déplacer le luminaire.
- Risque d'incendie ou d'électrocution. N'installez cette trousse que sur des luminaires qui ont les caractéristiques de construction et les dimensions telles que montrées sur les photographies et dessins présentes.
- Pour prévenir les dommages ou l'abrasion de fils électriques, ne pas exposer les fils aux arêtes de pièce de tôle ou n'importe quels autres objets tranchant.
- Respectez tous les codes NEC et codes locaux.

### CAUTION / ATTENTION

- Fixture may fall down if not installed properly, follow installation instructions.
- Wear safety glasses and proper aid during installation and maintenance.

- Le luminaire peut tomber s'il n'est pas installé correctement, suivre les instructions d'installation.
- Porter des lunettes de sécurité et les aides appropriées lors de l'installation et de l'entretien.

## Save These Instructions

Use only in the manner intended by the manufacturer. If you have any questions, contact the manufacturer.

## Materials Supplied With Luminaire

- LIB Series Luminaire
- Mounting Hardware
- Multiple-Length Power Supply Cords

## Prepare Electrical Wiring

### Electrical Requirements



The LED fixture must be supplied with 120VAC, 50/60 Hz and connected to an individual properly grounded branch circuit, protected by a circuit breaker. Use min. 75 C supply conductor.

### Electrical Requirements



The grounding and bonding of the overall system shall be done in accordance with the National Electric Code (NEC) Article 600 and local codes.

Provided Components

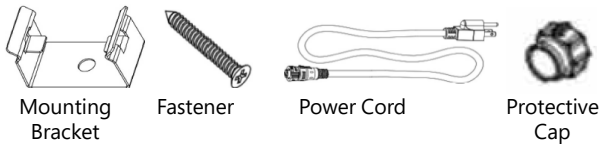

Optional Accessories

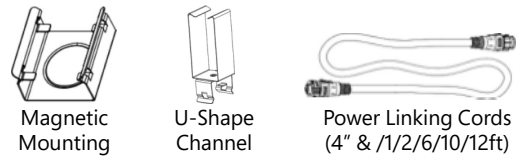

1 Single Fixture Installation

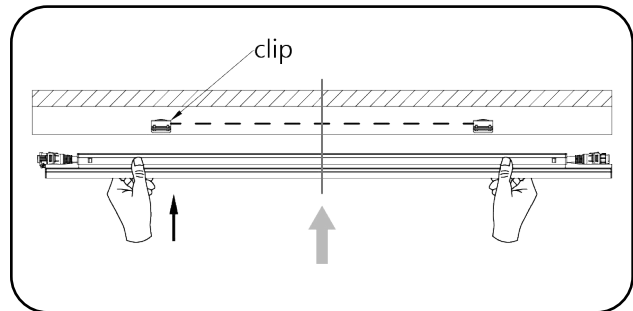
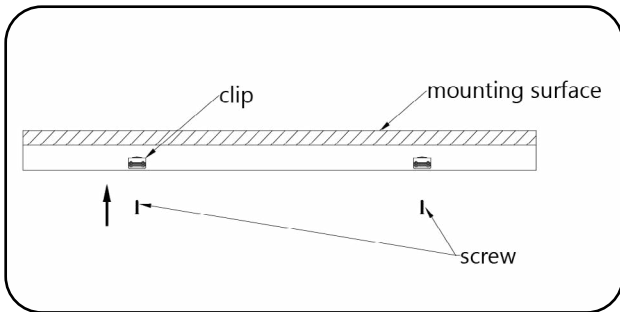

**A** Attach the mounting clips to the desired surface in a straight line using the provided screws. The distance between the two clips is determined by the length of the fixture, as noted in the chart below.

**B** Center the length of the fixture within the installed mounting clips. Press and snap the fixture into the mounting clips, with the male power connector facing the power supply drop.

fig. 1A

Fixture Length	2ft	3ft	4ft
Mounting Width	12-16in ~300-400mm	16-24in ~400-600mm	24-36in ~600-900mm

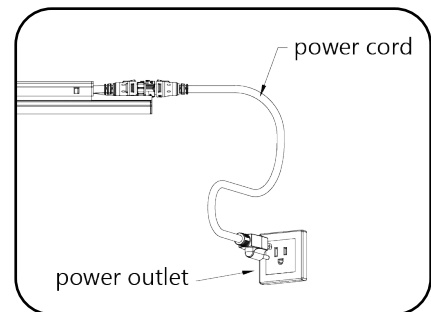
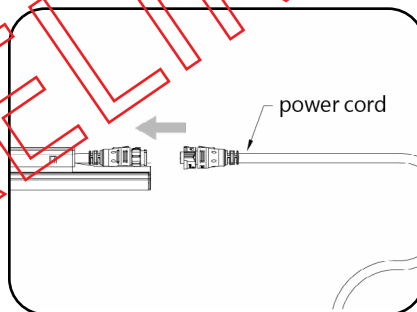
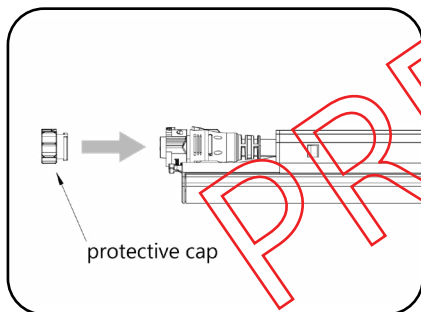

**C** Install the protective cap on the female connector of the fixture.

**D** Connect the power cord to the male connector. Remove the protective film on the diffuser.

**E** Plug the power cord into a 120VAC supplied outlet.

② Continuous Run Installation

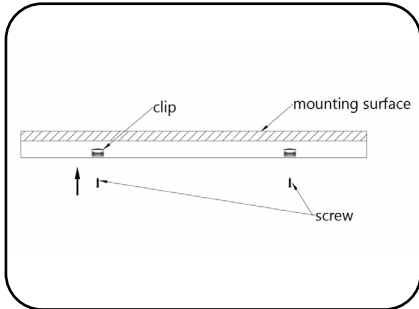

**A** Repeat step A of the “Single Fixture Installation” process. **Do not** provide a power source to the luminaire. **Do not** remove protective film.

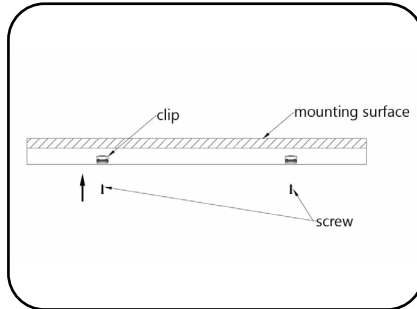

**B** Determine the desired spacing between luminaires. If additional space is desired between the luminaires, continue to Section 3A. Install the brackets for the remaining fixtures in a straight line, according to Fig. 1A.

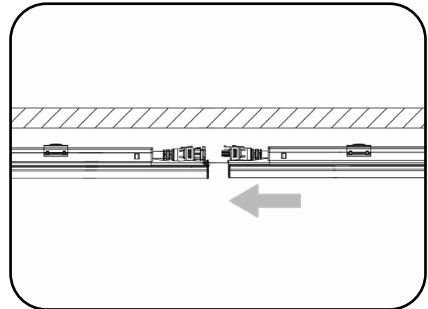

**C** Snap the second fixture into the correlating mounting brackets. Align the mating features on the male and female connectors. Press together until a “click” is heard.

**Note:** If you do not hear a click, the connection has not been properly made. Disconnect and retry until a “click” is heard

**Note:** If the dovetails will not align, adjustment to the mounting brackets or a linking cord may be necessary.

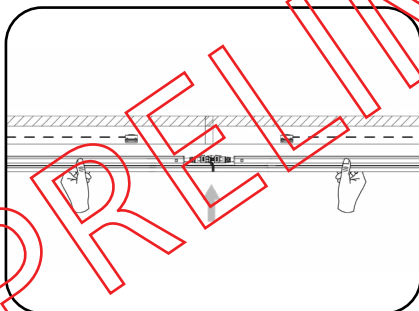

**D** Repeat step 2C until the desired number of fixtures are connected in a continuous run. Center the length of the fixtures within the installed mounting clips. Press and snap the fixture into the mounting clips, with the male power connector facing the power supply drop.

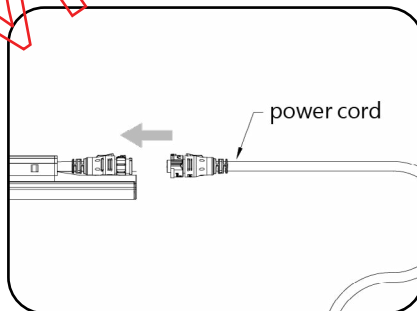

**E** Connect the power cord to the male connector. Connect the protective cap to the unused female connector. Remove the protective film on the diffuser.

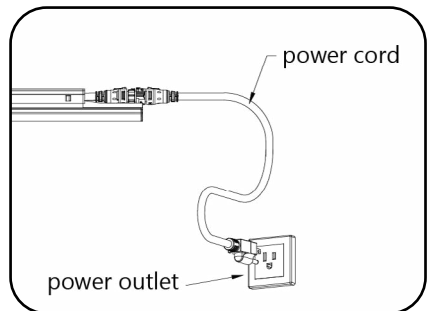

**F** Plug the power cord into a 120VAC supplied outlet.

③ Continuous Run Installation - Power Linking Cords

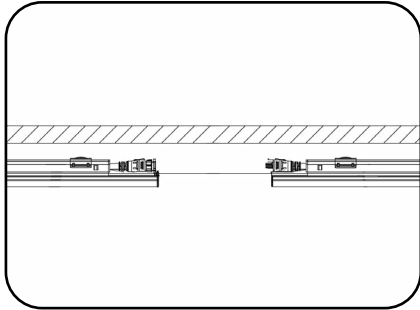

**F** “Snap” the luminaires into the correlating mounting brackets, centering the length of the fixtures within the brackets.

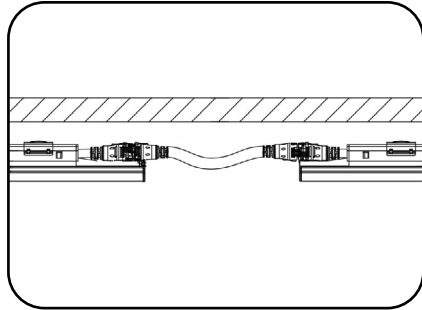

**G** Select the “linking cord” most similar in length to the gap between the two luminaires without causing strain. Connect the linking cord to male and female connectors respectively.

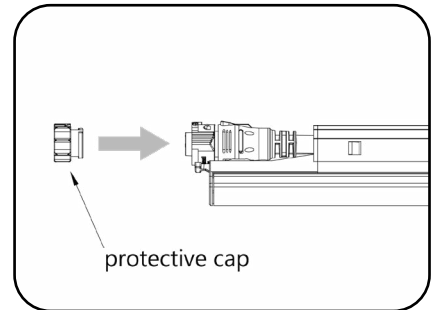

**E** Connect the power cord to the male connector. Connect the protective cap to the unused female connector. Remove the protective film on the diffuser.

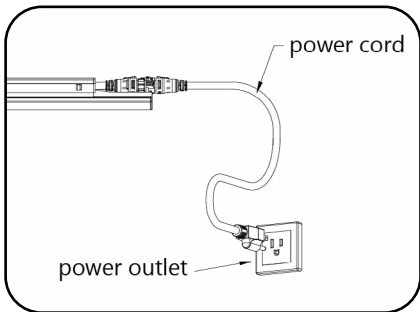

**F** Plug the power cord into a 120VAC supplied outlet.

PRELIMINARY

This device complies with Part 15 of the FCC Rules. Operation is subject to the following two conditions: (1) This device may not cause harmful interference, and (2) this device must accept any interference received, including interference that may cause undesired operation. CAN ICES-005 (A) / NMB-005 (A)

Note: This equipment has been tested and found to comply with the limits for a Class A digital device, pursuant to part 15 of the FCC Rules. These limits are designed to provide reasonable protection against harmful interference when the equipment is operated in a commercial environment. This equipment generates, uses, and can radiate radio frequency energy and, if not installed and used in accordance with the instruction manual, may cause harmful interference to radio communications. Operation of this equipment in a residential area is likely to cause harmful interference in which case the user will be required to correct the interference at his own expense.

**Questions | Web: LED.com | Phone: 1-888-694-3533**

All product and company names are trademarks or registered trademarks of their respective holders. Use of them does not imply any affiliation with or endorsement by them.  
All specifications are subject to change without notice.