

LUNAR CHANDELIER







IMPORTANT SAFETY INSTRUCTIONS:

- Consult certified electrician before installation that familiar with commercial type of applications.
- To reduce risk of fire, use 12-watt Compact Fluorescent lamp and do not exceed the recommended wattage.
- The manufacturer and distributor accepts no liability for incorrect installation.
- The ceiling must have at least the capacity of 5 times the weight of the ceiling light. For this light at least a ceiling capacity of 30 kg is required.
- Maximum Supply Current 1 A

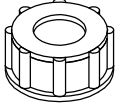
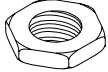
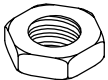
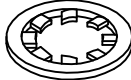
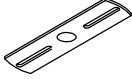
WARNING

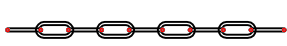
- Turn-off electricity supply at main circuit panel before installing. All wires are connected. Do not remove the ceiling light from its packaging by pulling on the power cord, as a bad connection may result.
- To reduce the risk of fire, electrical shock, or personal injury, always turn off the ceiling light and allow it to cool prior to replacing light bulb. Do not touch bulb when fixture is turned on or look directly at light bulb. Keep flammable materials away from light bulb.
- Deviation from instructions may result in a risk of fire or electric shock.
- Suitable for indoor use only.
- The external flexible cable or cord of this luminaire cannot be replaced; if the cord is damaged, the luminaire shall be destroyed.
- Terminal block not included. Installation may require advice from a qualified person.

SCREW TERMINAL BLOCK - Connect the cable of the luminaire with the screw terminal block approved in according with IEC/EN 60998-2-1 with minimal rated voltage 250-3 x 2,5 mm² at supply cable.

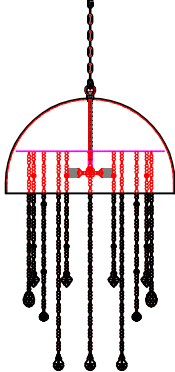
A		BLACK PLASTIC CORD PROTECTOR
B		3.5 MM THK. HEXAGONAL NUT
C		5 MM THK. HEXAGONAL NUT
D		SPRING WASHER
E		CROSS BAR
F		LONGER ALL-THREAD
G		PLAIN WASHER
H		CHAIN
I		CANOPY
J		FIXTURE LOOP
K		QUICK LINK (2PCS)
L		CHANDELIER

STEP #1

- Open the parts bag and place all on a flat surface.
- Remove the chandelier body and lay on a flat surface.
- Set-up the cross bar according the set of hardware as sketch below.

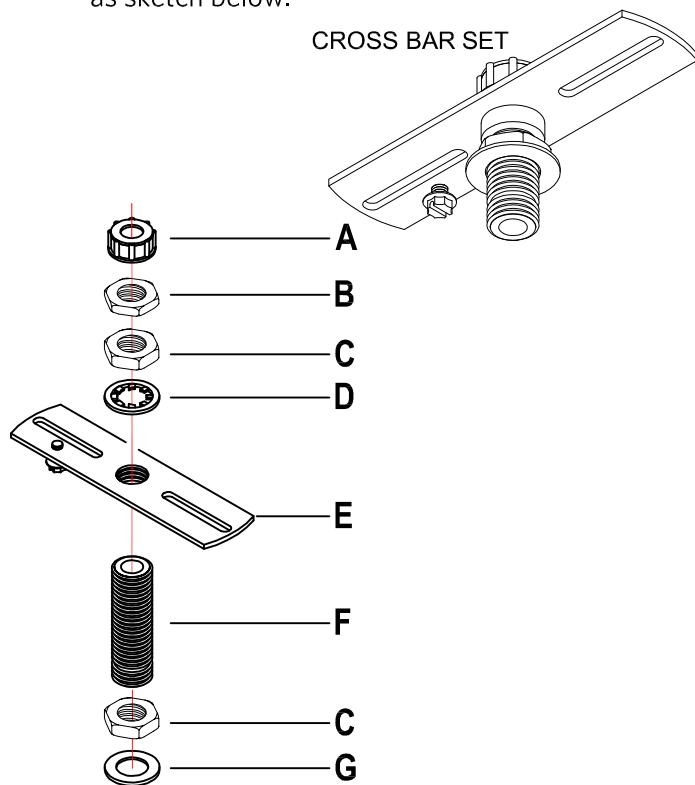

STEP #3

- Insert the electrical wire into the hole of the fixture loop (J), Canopy (I) and into the set of cross bar.
- Set the chandelier near the ceiling surface and Connect the wiring fixture into the junction box. Once the wiring is set then fasten the cross bar into the junction box.

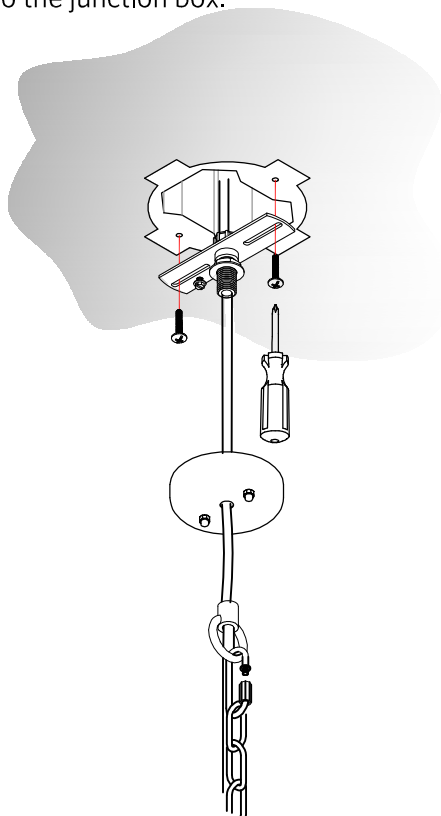

STEP #2

- Using a ladder, pre-set the chandeliers Chain (H) into the ceiling surface and measure the length of the chain (H) you needed in the installation.
- Cut the excess chain on your desired length after that connect this to the pre-installed fixture loop in the chandelier using Quick Link (K) provided.

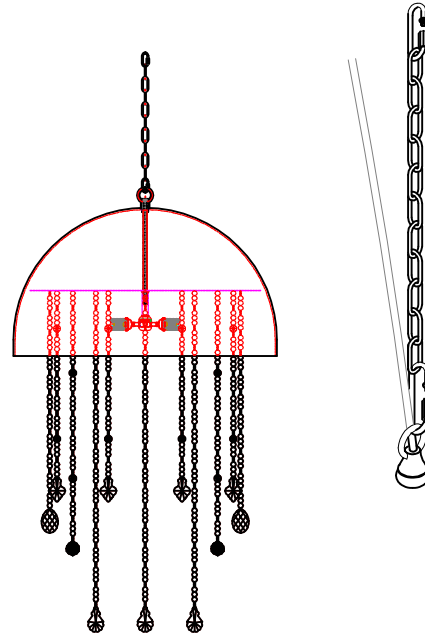

STEP #4

- Move the canopy (I) against the ceiling surface and screw the Fixture Loop (J) onto the all thread of the cross bar, once it's set, connect the chain into the Fixture Loop (J) using Quick Link (K) provided. Please see sketch below.

