

# General Engineering Catalog

Number 17A

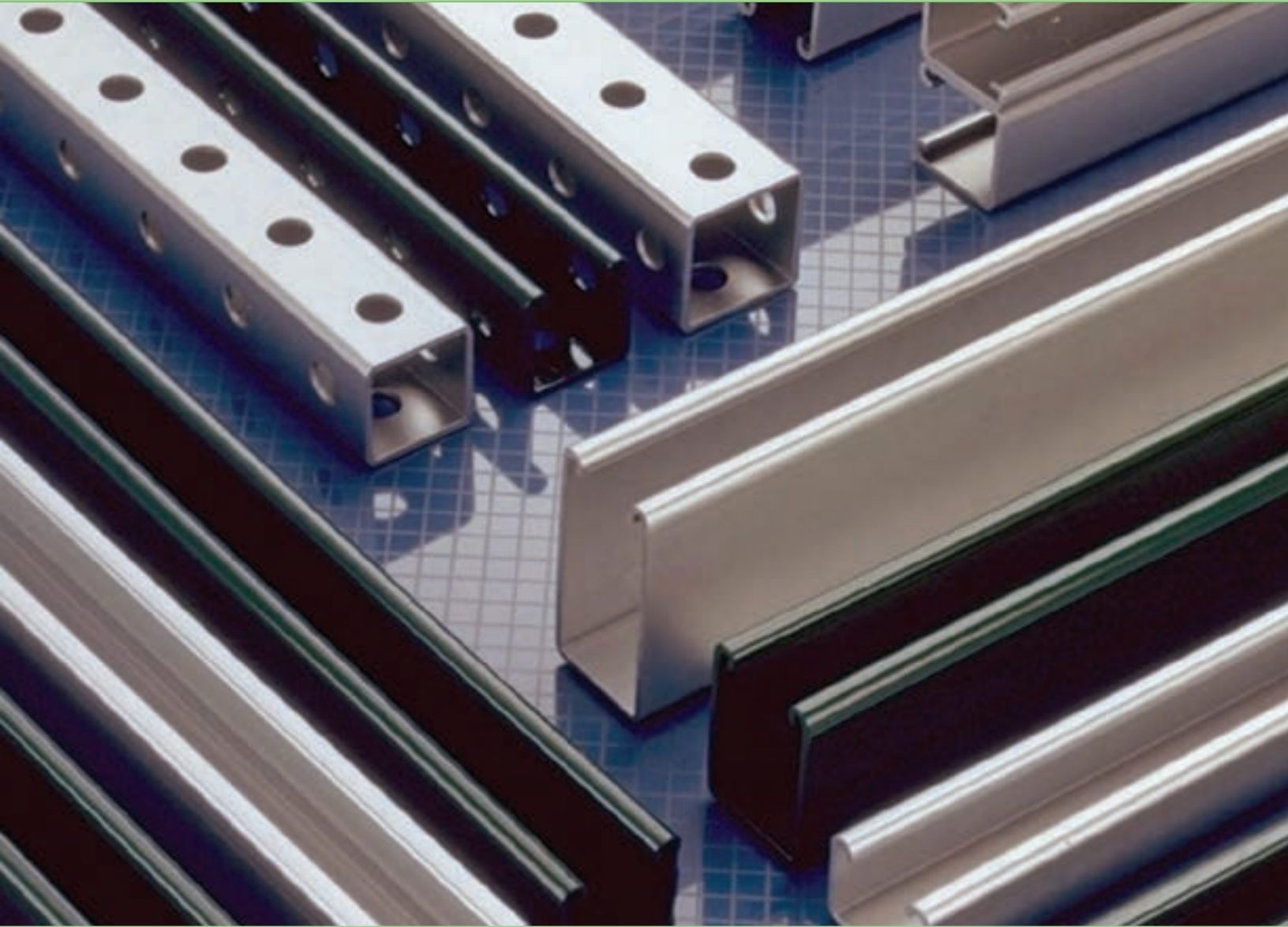

**Atkore**<sup>™</sup>  
Unistrut

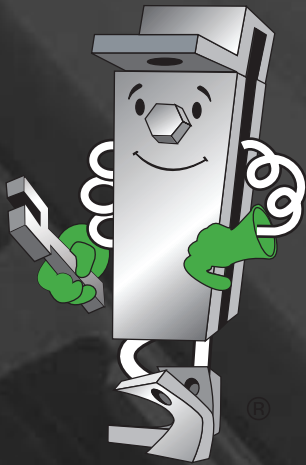

# Atkore™

## Unistrut

Unistrut is the original metal framing system featuring a unique weldless connection. The Unistrut system eliminates welding and drilling, and is easily adjustable and reusable for infinite configurations. Over time, our brand has evolved from a simple connection concept to a comprehensive engineered building and support system featuring a robust line of channels, fittings, fasteners, hangers, pipe clamps, and accessories. Backed by our worldwide network of engineering and distribution centers, we provide customers with total-resource capability, making Unistrut the brand everyone asks for by name.



# UNISTRUT®

**The Unistrut World of Support starts with our network of Unistrut Service Centers across the nation.**

**T**he Unistrut World of Support starts with our network of Unistrut Service Centers across North America. They go far beyond providing local product inventories... by offering complete application solutions, based on experience gained from thousands of projects worldwide.

It's the kind of knowledgeable assistance that can help save time and cost now, and simplify change in the future.

Technical help? No one knows the engineering side of Unistrut support systems like your local Unistrut team. And if it's special fabrication, cutting or custom finishing you want, the pros at your local Unistrut Service Center will make it happen...quickly, efficiently, economically.

So when it's help you need, call your Unistrut Service Center—the quickest way to unlock Unistrut's World of Support.

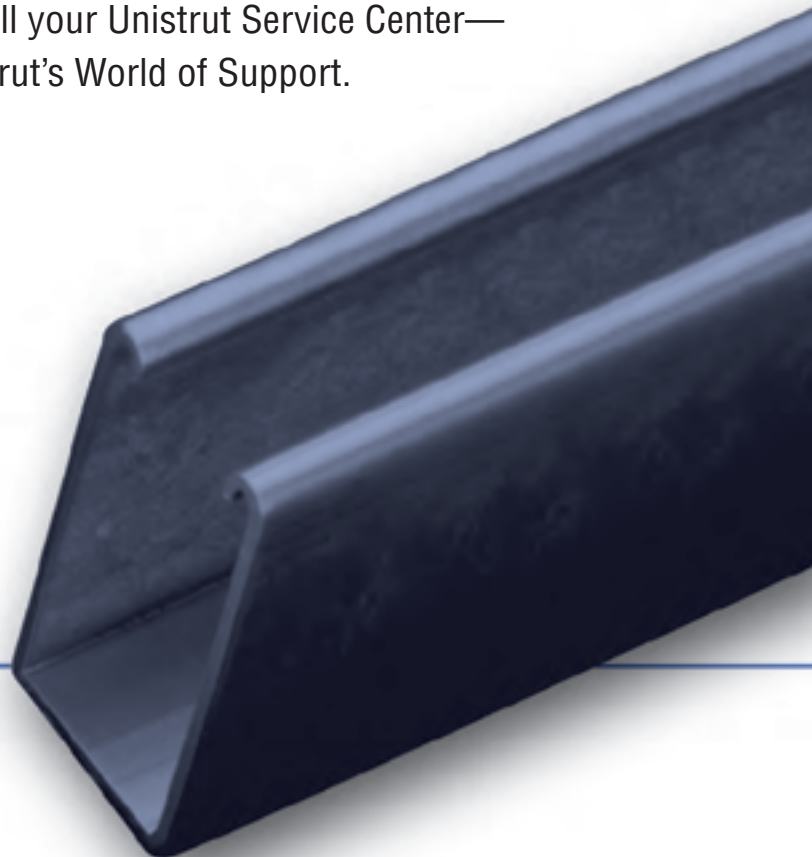
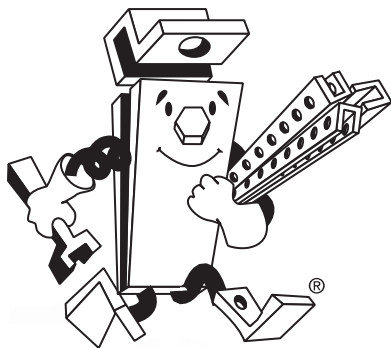

# TABLE OF CONTENTS

## INTRODUCTION . . . . . 2-20

Unistrut Introduction . . . . .	2-3
Table of Contents . . . . .	4-5
Unistrut Metal Framing Systems . . . . .	6-9
Quality Assurance . . . . .	10
Materials and Finishes . . . . .	11 - 13
Design Fundamentals . . . . .	14 - 15
Conversion Factors . . . . .	16
Reference Tables and Data . . . . .	17 - 18
Guide Specification . . . . .	19
New Products . . . . .	20

## 1<sup>5</sup>/<sub>8</sub>" CHANNEL . . . . . 21-62

Channel Selection Chart . . . . .	23
P1000 (12 Gauge) . . . . .	24 - 29
P1100 (14 Gauge) . . . . .	30 - 32
P2000 (16 Gauge) . . . . .	33 - 35
P3000 (12 Gauge) . . . . .	36 - 38
P3300 (12 Gauge) . . . . .	39 - 41
P4000 (16 Gauge) . . . . .	42 - 44
P4100 (14 Gauge) . . . . .	45 - 47
P4400 (12 Gauge) . . . . .	48 - 50
P4520 (12 Gauge) . . . . .	51 - 53
P5000 (12 Gauge) . . . . .	54 - 56
P5500 (12 Gauge) . . . . .	57 - 59
Closure Strips . . . . .	60
End Caps and Frame Caps . . . . .	61
Lateral Bracing Load Reduction Chart & Bearing Loads . . . . .	62

## TELESTRUT® SYSTEM . . . . . 63-70

Telescoping Tube . . . . .	65 - 67
Connection Methods . . . . .	69
Specialized Fittings . . . . .	68
Post Bases . . . . .	68 - 69
Cutting Chart . . . . .	70



## NUTS & HARDWARE . . . . . 71-76

Channel Nuts . . . . .	72 - 73
Top Retainer Nuts . . . . .	73
Stud Nuts . . . . .	74
Hardware . . . . .	74 - 76
Threaded Rod . . . . .	75

## GENERAL FITTINGS . . . . . 77-106

Flat Plate Fittings . . . . .	81 - 82
Ninety Degree Fittings . . . . .	82 - 85
Angular Fittings . . . . .	85
"Z" Shape Fittings . . . . .	86
"U" Shape Fittings . . . . .	87 - 88
Wing Shape Fittings . . . . .	89 - 90
Post Bases . . . . .	90
Brackets . . . . .	90 - 93
Brace Fittings . . . . .	94
Beam Clamps . . . . .	95 - 101
Trolleys . . . . .	102
Special Application Fittings . . . . .	103 - 104
Seismic Retrofit Fittings . . . . .	104 - 106

## PIPE/CONDUIT SUPPORTS . . . . . 107-126

Pipe/Conduit Clamps . . . . .	108 - 111
Unicushion® . . . . .	112
Pipe & Tubing (Cush-A-Clamp®) Clamps . . . . .	113 - 116
Pipe Hangers . . . . .	117
Pipe Rollers . . . . .	117 - 119
Pipe Brackets . . . . .	119
Reference Tables . . . . .	120 - 126

## ELECTRICAL FITTINGS . . . . . 127-138

Electrical Fittings . . . . .	128 - 130
Receptacles . . . . .	131
Fixture Hangers . . . . .	131
Accessories and Connectors . . . . .	132
Junction Boxes . . . . .	132
In-Channel Joiners . . . . .	133
Swivel Hangers . . . . .	133
Cable Entrance Tubing and Accessories . . . . .	134 - 136
Electrical Fittings Technical Data . . . . .	137 - 138

## CONCRETE INSERTS . . . . . 139-146

Heavy-Duty Inserts . . . . .	141
Standard-Duty Inserts . . . . .	142, 144
Light-Duty Inserts . . . . .	143
Spot Inserts . . . . .	144
Deck Inserts . . . . .	145
Components . . . . .	145
Technical Data . . . . .	146

## SOLAR COMPONENTS . . . . . 147-150

Application Example . . . . .	148
Solar Connectors . . . . .	149
Key Advantages . . . . .	150

**UNIPIER® ..... 151-168**

Sleeper Support ..... 153 - 154  
 Strut Support ..... 155 - 158  
 Conduit Supports  
 Mounted Support, Polycarbonate Base ..... 157  
 Elevated Support, Polycarbonate Base ..... 157  
 Elevated Support, Steel Base ..... 158  
 Gas and Mechanical Supports  
 Mounted Support, Polycarbonate Base ..... 158  
 Mounted Support, w/Roller Polycarbonate Base ..... 158  
 Elevated Support, w/Roller, Polycarbonate Base ..... 159  
 Elevated Support, w/Roller, Steel Base ..... 160  
 Accessories  
 Spacer ..... 160  
 Support Pads, Deck Plates ..... 160  
 Pipe Hanger Bases, Polycarbonate and Steel ..... 161  
 Fabricated Supports  
 Single Base Trapeze ..... 162  
 Double Base Trapeze ..... 163  
 Heavy Duty Double Base Trapeze ..... 163  
 Double Base Duct Support ..... 163  
 Mechanical Supports ..... 164  
 Bridge Cross-Over, Walkway, Service Platform or Ramp ..... 164  
 Installation ..... 165  
 Pipe Diameters and Loading ..... 166  
 Technical Data ..... 167 - 168

**1 1/4" FRAMING SYSTEM ..... 169-177**

A1000 (14 Gauge) ..... 171 - 172  
 A3300 (14 Gauge) ..... 173 - 174  
 Channel Nuts and Closure Strips ..... 175  
 Flat Plate Fittings ..... 175 - 176  
 Ninety Degree Fittings ..... 176  
 Angle and Wing Shape Fittings ..... 176  
 "U" Shape Fittings ..... 177  
 Pipe / Tubing Clips ..... 177  
 Brackets ..... 177

**1 3/16" FRAMING SYSTEM ..... 178-187**

P6000 (19 Gauge) ..... 179 - 181  
 P7000 (19 Gauge) ..... 182 - 183  
 Channel Nuts, End Caps, and Closure Strips ..... 184  
 Flat Plate Fittings ..... 184 - 185  
 Ninety Degree Fittings ..... 185  
 Angular Fittings, Wing Shape Fittings ..... 186  
 "Z" Shape Fittings ..... 186  
 "U" Shape Fittings ..... 186 - 187  
 Special Application Fittings ..... 187  
 Beam Clamps ..... 187  
 Tubing Clips ..... 187

**FIBERGLASS SYSTEM ..... 188-203**

Heavy Duty Channel (Flange Profile) ..... 190

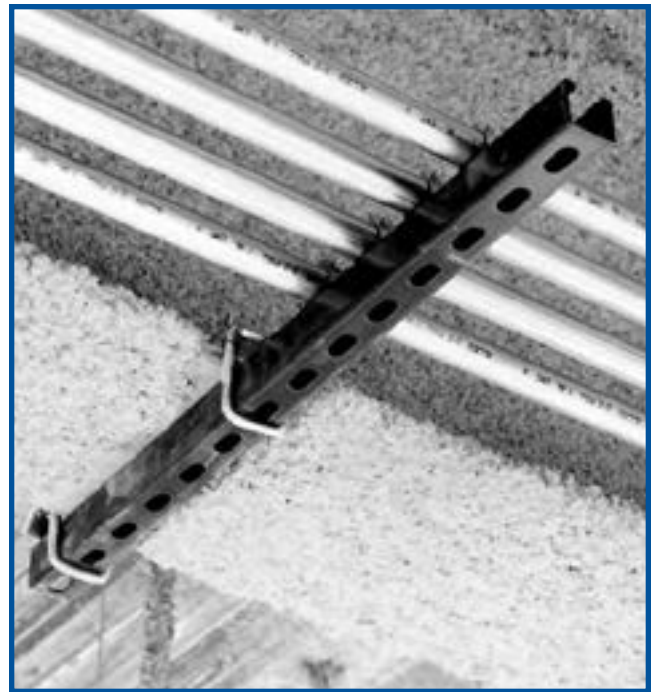

Light Duty Channel (Flange Profile) ..... 191  
 Heavy Duty Channel (SST Profile) ..... 192  
 Nuts & Hardware ..... 193 - 195  
 Fittings ..... 196 - 197  
 Pipe Clamps and Straps ..... 198  
 Clevis Hangers and Channel Inserts ..... 199  
 Beam Clamps ..... 200  
 Power Rack Stanchions ..... 200  
 Chemical Compatibility ..... 201 - 202  
 Specifications ..... 203

**SPECIAL METALS ..... 204-209**

Stainless Steel Channel ..... 206  
 Stainless Steel Nuts and Closure Strips ..... 207  
 Aluminum Channel ..... 208 - 209  
 Aluminum Closure Strips and End Caps ..... 209

**PRIMEANGLE™ ..... 210-215**

PrimeAngle™ ..... 211  
 Accessories ..... 212  
 PrimeAngle™ Technical Data ..... 213 - 215

**UNITED INTERLOCK® GRATING... 216-231**

Ease of Installation ..... 217  
 Plank Grating ..... 218 - 219  
 Accessories ..... 220 - 222  
 Heavy Duty Stair Treads ..... 223  
 Design and Testing ..... 224  
 Plank Loads and Deflections ..... 225 - 230  
 Architectural Specifications ..... 231

**ROOFWALKS® ..... 232-233**

Roofwalk® Grating Planks ..... 233  
 Hardware for Membrane, Foam or Coated Roof ..... 233  
 Standing Seam Installation ..... 233

**INDEX ..... 234-239**





## Featuring The Unique Weldless Connection

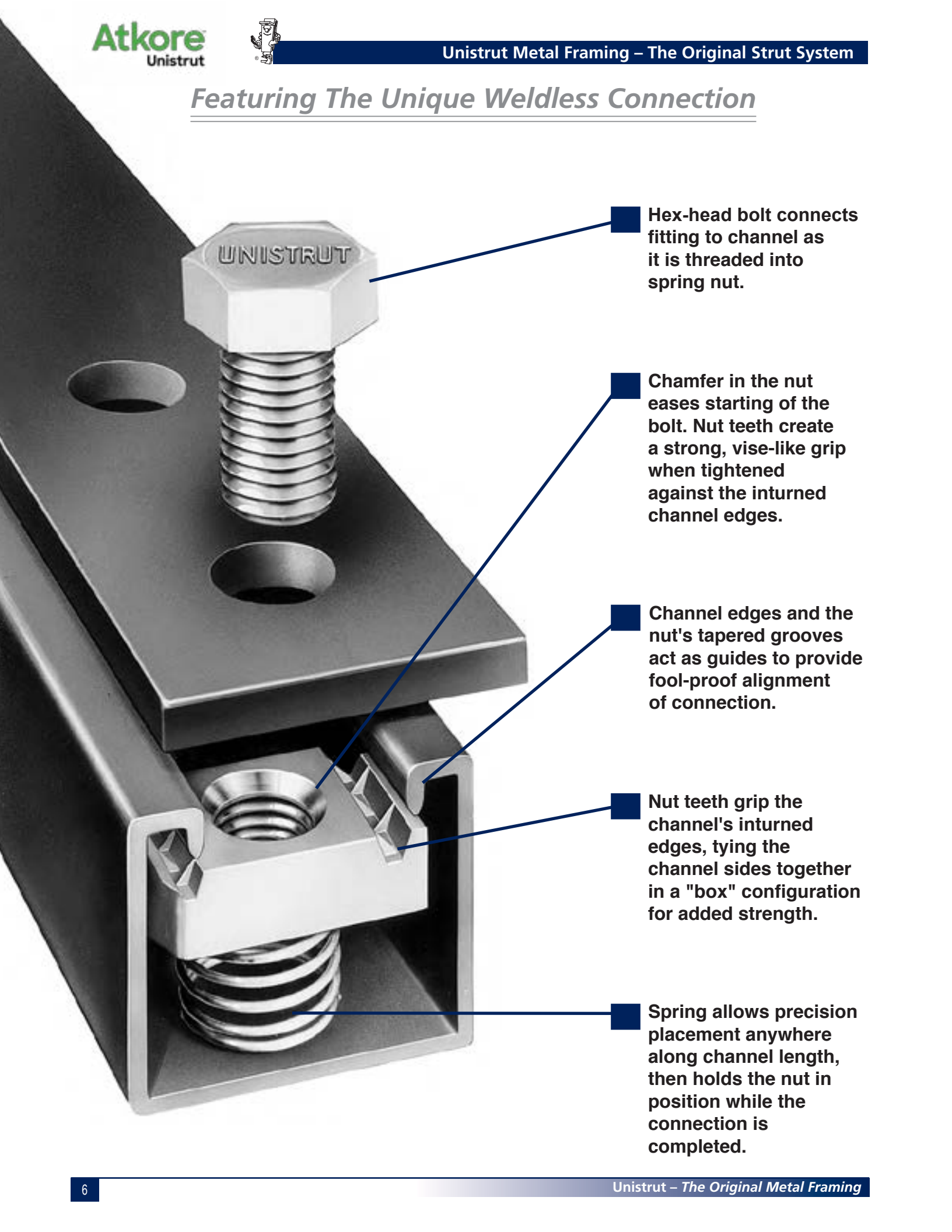

Hex-head bolt connects fitting to channel as it is threaded into spring nut.

Chamfer in the nut eases starting of the bolt. Nut teeth create a strong, vise-like grip when tightened against the intumed channel edges.

Channel edges and the nut's tapered grooves act as guides to provide fool-proof alignment of connection.

Nut teeth grip the channel's intumed edges, tying the channel sides together in a "box" configuration for added strength.

Spring allows precision placement anywhere along channel length, then holds the nut in position while the connection is completed.

## Strong, Fast, Economical and Adjustable

Insert the spring nut anywhere along the continuous slotted channel. The rounded nut ends permit easy insertion.

1

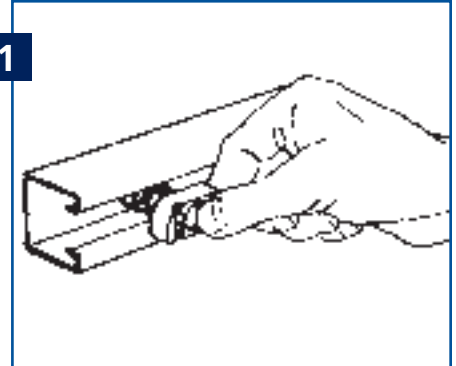

2

A 90° clockwise turn aligns the grooves in the nut with the inturned edges of the channel.

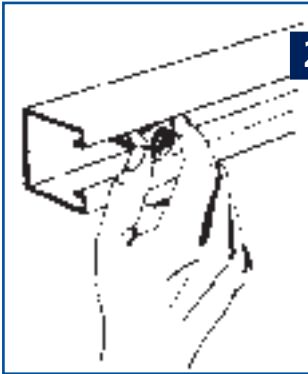

Fittings can be placed anywhere along the channel opening, permitting complete freedom of adjustment. The need for drilling holes is eliminated.

3

Insert the bolt through the fitting and into the spring nut. (See illustration 5 for end view showing the nut in place)

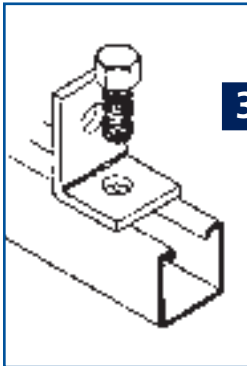

4

Additional channel sections can now be bolted to the fitting already in place by following procedure described in steps 1–3.

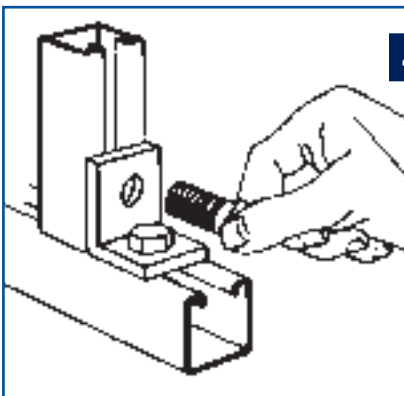

Tightening with a wrench locks the serrated teeth of the nut into the inturned edges of the channel, to complete a strong, vise-like connection.

5

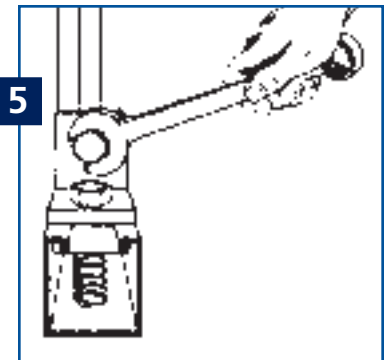

- 100% Adjustable
- 100% Reusable
- No Welding
- No Drilling
- No Special Tools



**Serving Design Professionals for Over 85 Years**

Unistrut products have been helping to build a better world since 1924. Used extensively in nuclear, industrial and commercial construction markets for over 85 years, Unistrut Metal Framing has set the standard for product design, quality and performance. The initial Unistrut concept — a simple spring nut and bolt connecting a fitting to a continuous slotted channel — has evolved into a comprehensive engineered building and support system.

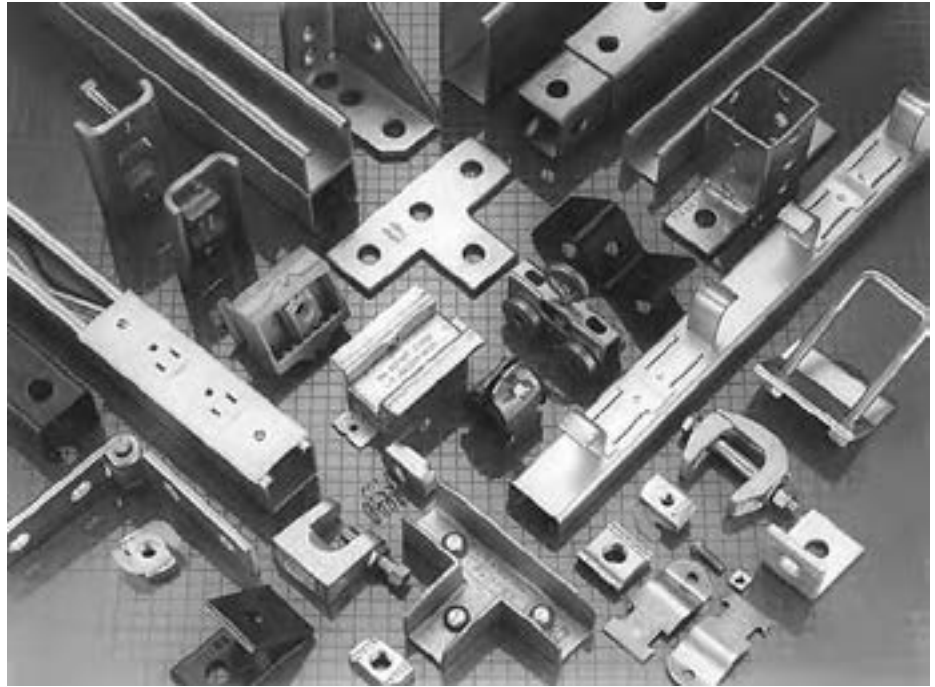

**Unistrut® — The Original Metal Framing System**

There is only one Unistrut Metal Framing System. It incorporates the innovative product improvements that

our research and development group has created to give you the most complete and flexible support system available. Backed by our worldwide network of engineering and distribution centers, Unistrut provides customers with total-resource capability.

A North American network of Unistrut Service Centers — stocking standard Unistrut components — are located in principal cities to serve you quickly and directly. Many Service Centers are equipped to design and supply drawings for any type of metal framing application and also offer fabrication and installation services.

This catalog is a comprehensive presentation of Unistrut Metal Framing components plus technical data required by design, specification and construction professionals.

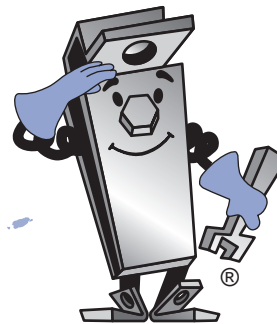



**THE MOST COMPLETE METAL FRAMING SYSTEM — FOUR CHANNEL-WIDTH OPTIONS**

Adjustability, demountability and reusability are engineered into each of the four Unistrut channel series. Each series offers channels of varying depth and gage plus a complete line of fittings and accessories.

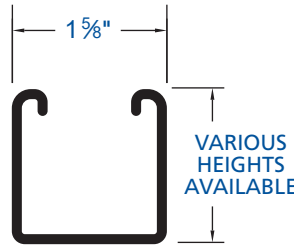

**1 5/8" (41.3 mm) width**

Designed to carry the heaviest loads and provide the widest variety of applications, the 1 5/8" series has become the accepted standard for use in mechanical, electrical and general construction applications where supports and attachments must meet the highest strength requirements.

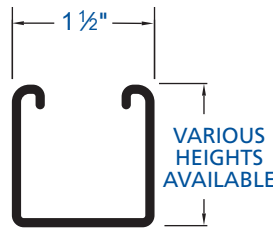

**1 1/2" (38.1 mm) width**

A framing system designed for medium to heavy loads, the 1 1/2" series offers hole spacing and fittings where all parts fit together, no matter where they're used, or at what angle.

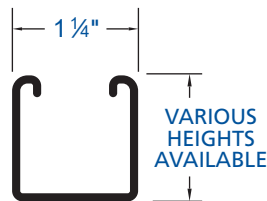

**1 1/4" (31.8 mm) width**

A framing system designed for medium loads, the 1 1/4" series is especially suitable for use in the OEM, commercial and display markets. It maintains a lightness in scale and a clean line that makes it aesthetically pleasing as well as functional.



**1 3/16" (20.6 mm) width**

A unique half-size reduction of the 1 5/8" channel-width series, this smaller channel size can be used to carry light loads economically in applications such as instrumentation, retail displays and light-duty laboratory supports. It also provides the flexibility found in all Unistrut framing systems.



**PRODUCT LOAD TESTING**

Product testing is an important part of Unistrut's Quality Assurance Program. We utilize our own testing facilities, as well as those of independent testing laboratories, to determine design loads with proper and adequate safety factors. These design loads are indicated, where applicable, throughout the catalog. Loads are based on AISI Specification For The Design Of Cold-Formed Steel Structural Members, 2007 Edition.

Destructive and non-destructive testing procedures are used to test for variables such as corrosion, conductivity, electro-static dissipation, ultra-violet resistance, wind resistance, dimensional accuracy, material integrity and slip resistance.

In short, if there's a specification to meet, Unistrut will develop a test to quantify and verify it. Using design properties of the Unistrut framing members, load

data given in this catalog, and/or design procedures of the American Iron & Steel Institute Specification For The Design Of Cold-Formed Steel Structural Members, 2007 Edition, it is possible to design any type of structure within the capabilities of the system.

Assemblies or connections that cannot be calculated using provisions of the AISI specifications must be established by application-specific tests.

**QUALITY PROGRAM**

Unistrut is committed to being the "best" in the metal framing industry. In order to meet this goal, Unistrut has adopted the philosophy of "Zero Defects and Continuous Improvement". This means on-going reviews of our manufacturing processes,

operating procedures and quality systems to find ways of improving efficiency, productivity and quality. It means establishing process controls and problem-prevention techniques to ensure that superior quality is built into every Unistrut product.

Our drive to be the best includes not just quality products, but on-time delivery and prompt resolution of customer needs and concerns. At Unistrut, quality is number one.

**TRACEABILITY**

Unistrut channel is stamped with a numeric code that allows traceability to the origin of the steel



**MATERIAL**

**Framing Members**

Unistrut channels and continuous inserts are accurately and carefully cold-formed to size from low carbon strip steel. One side of the channel has a continuous slot with inturned edges. Secure attachments may be made to the framing member with the use of hardened, toothed, slotted nuts which engage the inturned edges.

Raw steel shall conform to the following ASTM specifications:

GAGE	FINISH	ASTM NO.
12	GR & HG	A1011 SS GR 33
	PG	A653 GR 33
14	GR & HG	A1011 SS GR 33
	PG	A653 GR 33
16	GR & HG	A1011 SS GR 33
	PG	A653 GR 33
19	GR	A1008

**WEIGHTS AND DIMENSIONS**

Weights given for all materials are approximate shipping weights. All dimensions are subject to commercial tolerance within published specifications.

**Nuts and Bolts**

Unistrut nuts are made from steel bars. After all machining operations are complete, they are thoroughly case hardened. Nuts are rectangular with ends shaped to permit a quarter turn clockwise in the framing member after insertion through the slotted opening in the channel. Two toothed grooves in the top of the nut engage the inturned edges of the channel and, after bolting operations are completed, will prevent any movement of the bolt and nut within the framing member.

All bolts and nuts have Unified coarse screw threads. The standard framing nut is 1/2" and conforms to ASTM A576 GR 1015 modified and A1011 SS GR 45. Screws conform to SAE J429 GR 2.

**Fittings**

Unistrut fittings, unless noted otherwise, are punch-press made from hot rolled, pickled and oiled steel plates, strip or coil, and conform to ASTM specifications A575, A576, A635 or A36. The fitting steel also meets the physical requirement of ASTM A1011 SS GR 33. The pickling of the steel produces a smooth surface free from scale.

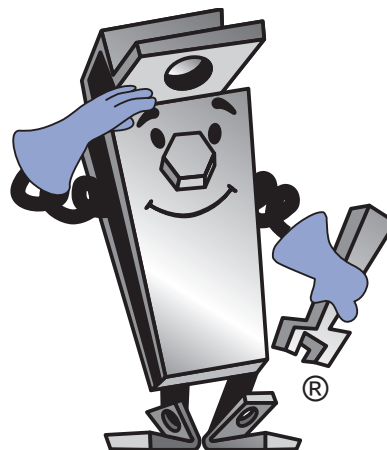

WE RESERVE THE RIGHT TO MAKE SPECIFICATION CHANGES WITHOUT NOTICE.

WHILE EVERY EFFORT HAS BEEN MADE TO ASSURE THE ACCURACY OF INFORMATION CONTAINED IN THIS CATALOG AT THE TIME OF PUBLICATION, WE CANNOT ACCEPT RESPONSIBILITY FOR INACCURACIES RESULTING FROM UNDETECTED ERRORS OR OMISSIONS.

THE BLUE COLOR USED ON UNISTRUT COMPONENTS ILLUSTRATED IN THIS CATALOG IS FOR GRAPHIC ENHANCEMENT ONLY, AND DOES NOT REPRESENT ACTUAL PRODUCT COLOR.



**Perma-Green® III**

The performance of Unistrut's Perma-Green III far exceeds that of conventional finishes. And compared to competitive "high-performance" coatings, Perma-Green III provides superior resistance to chalking, checking and fading and is far less vulnerable to common acidic atmospheres, solvents and alkalis.

Just as important, Perma-Green III is the result of an environmentally neutral process that virtually eliminates the toxic metals commonly found in competitive paint-based finishes.

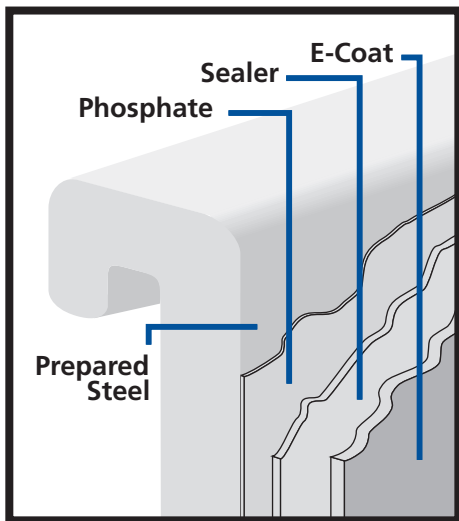
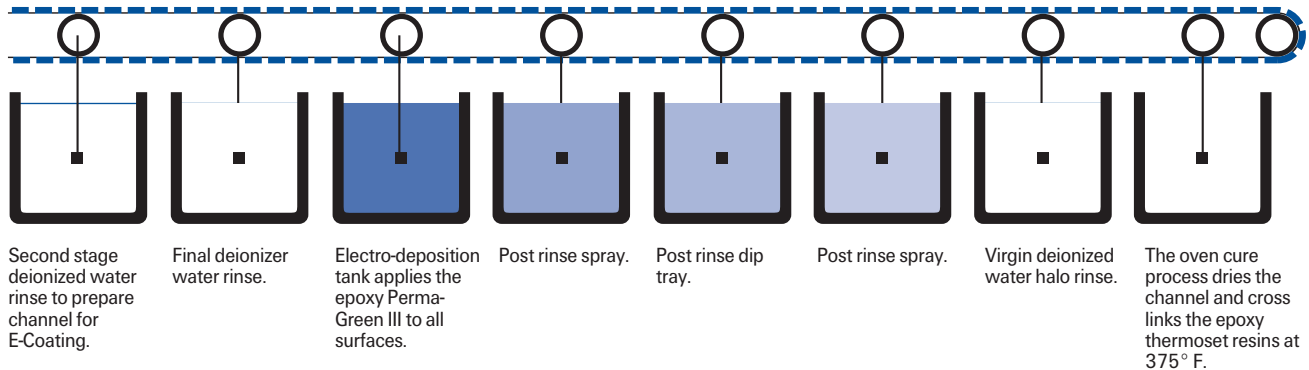
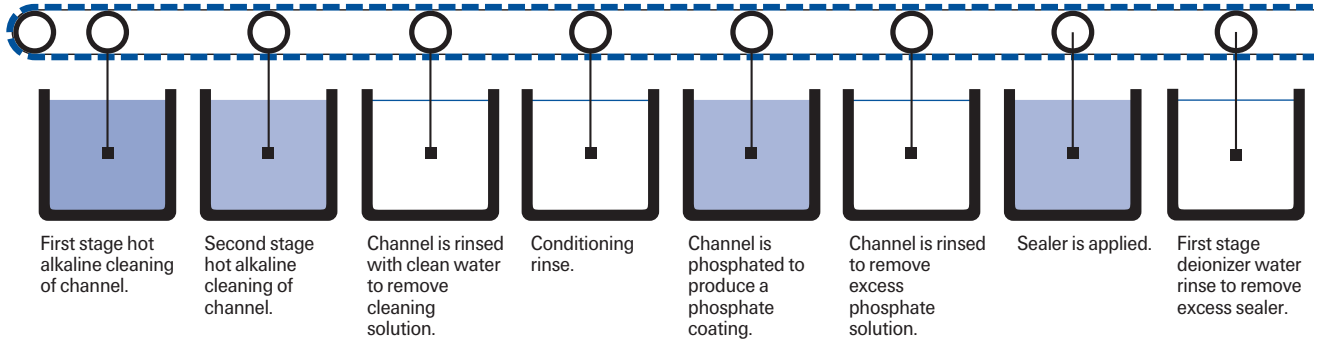

**PERMA-GREEN® III (GR) TECHNICAL DATA**

**STEEL SUBSTRATE PREPARATION**

Ten stage continuous cleaning, phosphate process.  
Substrate after "prep": sealed phosphate conversion coating.

**COATING**

Thermoset epoxy  
Color:  
Federal Highway Green  
Color Tolerance Chart  
PR Color No. 4  
Hardness: 2H.  
Coating Process:  
Cathodic Electrodeposition.

**PERFORMANCE**

Salt Spray:  
Scribed: exceeds 400 hours per ASTM B117. (1/8" creep)  
Unscribed: exceeds 600 hours per ASTM B117. (6% red rust)  
Chalk:  
Nominal at 1,000 hours per weatherometer G-23 test.  
Checking:  
None at 1,000 hours per weatherometer G-23 test.  
Fade:  
Less than 50% compared to standard epoxy E.C. coatings.

**ENVIRONMENTAL ISSUES**

Formulated as a "heavy metal"-free coating (trace elements only).  
Outgassing in service: essentially none at 350°F for 24 hours.

**Finishes**

**PLAIN (PL)**

Plain finish designation means that the channel retains the oiled surface applied to the raw steel during the rolling process. The fittings have the original oiled surface of the coil or strip steel material.

**Pregalvanized Zinc (PG)  
ASTM A653**

Pregalvanized steel is zinc coated by a hot dip process. Steel strip from a coil is fed through a continuous zinc coater which cleans, fluxes and coats the steel with molten zinc. After cooling, the steel is recoiled.

The pregalvanized zinc coating conforms to a G-90 thickness designation per ASTM A653. The zinc thickness is .75 MIL or .45 oz./sq. ft. of surface area.

This coating is offered on Unistrut channel and tubing and is a well-proven, time-tested performer for indoor and outdoor applications. For severe corrosion applications, hot dip galvanizing, as described below, is a good alternative.

**HOT DIP GALVANIZED (HG)  
ASTM A123 OR A153**

In hot dip galvanizing, the finished part is immersed in a bath of molten zinc. This method results in complete zinc coverage and a thicker coating than pregalvanized or plated zinc.

The zinc coating is typically 2.6 MIL or 1.5 oz./sq. ft. of surface area.

This is the coating of choice for applications where severe corrosion is a design factor.

**SPECIAL COATING**

When specific applications require other than standard available finishes, special finishes can be supplied per customer requirements.

**Electroplated Zinc (EG)  
ASTM B633, Type III SC1 or SC3**

In the electroplating process, the part to be zinc coated is immersed in a solution of zinc ions. An electric current causes the zinc to be deposited on the part.

SC1 (Mild) has a Zinc coating of 0.2 and is recommended for dry indoor use. SC1 is the standard finish thickness.

SC3 (Severe) has a Zinc coating of 0.5 mill and is the standard finish thickness only on UL Listed raceway products.

**Perma-Gold (ZD)  
ASTM B633, Type II SC3**

Similar to the EG process except in a yellow color.

**Unistrut Defender (DF)**

Unistrut® Defender™ is a combination of two proprietary material coatings conforming to ASTM standards A1046 and A1059. Channel, Fittings and Pipe Clamps meet the physical requirements of ASTM A1011 SS GR 33, ASTM A1046 SS GR 33, or ASTM A1011 HSLAS GR 45 Class 2.

*3X the corrosion resistance of HG!*

**Zinc Coating**

Unistrut products are available in four types of zinc coatings:

- Electroplated (EG)
- Perma-Gold (ZD)
- Pregalvanized (PG)
- Hot Dip Galvanized (HG).

Zinc offer two types of protection:

- **Barrier:** The zinc coating protects the steel substrate from direct contact with the environment.
- **Sacrificial:** The zinc coating will protect scratches, cut edges, etc. through an anodic sacrificial process.

The service life of zinc coating is directly related to the zinc coating thickness as shown below.

Comparison of Zinc Finishes	
Finish	Zinc Thickness
Hot Dip Galvanized	2.6 MIL
Pre-galvanized	0.75 MIL
Electro-Galvanized (SC1)	0.2 MIL
Electro-Galvanized (SC3)	0.5 MIL
Perma-Gold (SC3)	0.5 MIL

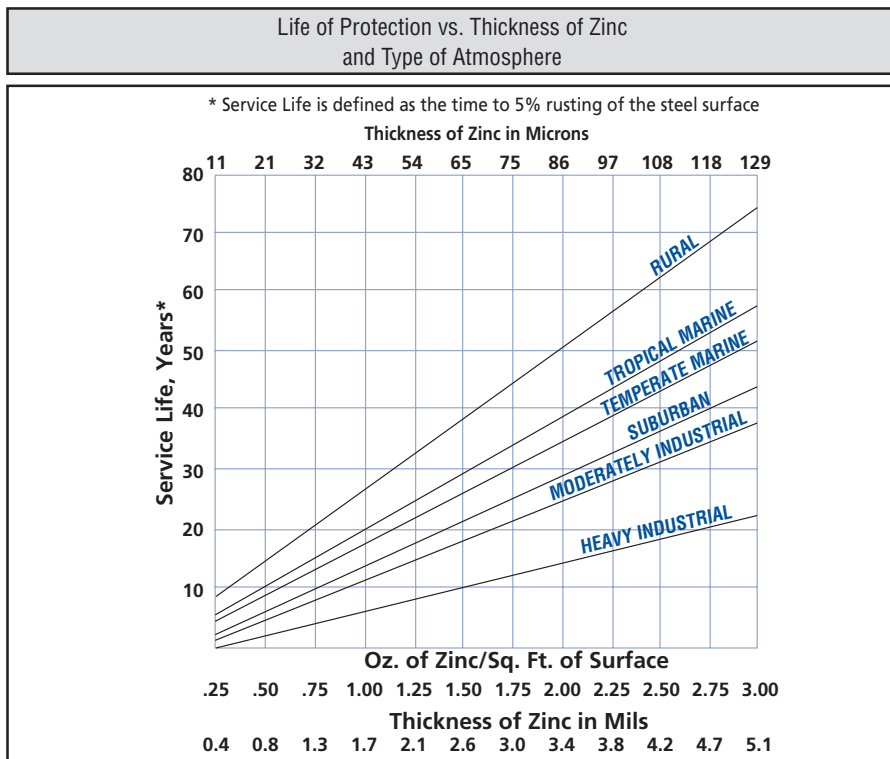



**BEAMS**

Beams are structural members loaded at right angles (perpendicular) to their length. Most beams are horizontal and subjected to gravity or vertical loads, e.g. a shelf support. However a vertical member can act as a beam under certain conditions, such as a curtain wall mullion subjected to wind loading. The bending moment developed in a beam is dependent on:

- (a) The amount of load applied,
- (b) The type of loading applied, and
- (c) The support conditions

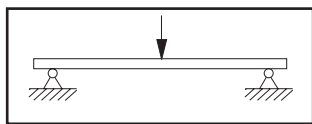

**BEAM LOADING - POINT LOAD**

A load concentrated onto a very small length of the beam is a point load.

**BEAM LOADING - UNIFORM LOAD**

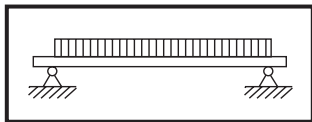

A load spread evenly over a relatively long length of the beam is a uniform load.

Point and uniform loads can be placed on a beam in any combination. A series of point loads can approximate a uniform loading. The load charts and tables are based on a uniform load unless identified otherwise.

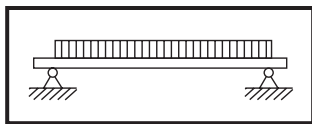

**SUPPORT CONDITIONS - SIMPLE BEAM**

A simple beam has supports that prevent movement left and right, or up and down, but do not restrain the beam from rotating at the supports into a natural deflected curve. Most Unistrut Metal Framing connections produce simple beams. The load charts and tables are based on simple beams unless identified otherwise.

**SUPPORT CONDITIONS - CONTINUOUS BEAM**

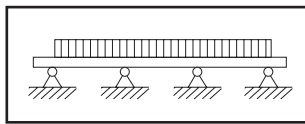

Any simple beam that is supported at one or more intermediate points is a continuous beam. A mezzanine joist that passes over three or more columns is an example of a continuous beam.

**SUPPORT CONDITIONS - FIXED-END BEAM**

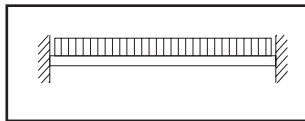

Supports that prevent the beam from rotating into a natural deflected curve produce a fixed-end beam. A welded end connection to very rigid support produces a fixed-end beam.

**SUPPORT CONDITIONS - CANTILEVER BEAM**

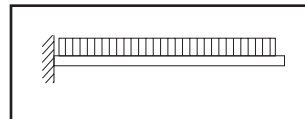

A cantilever beam is a fixed-end beam that is supported at one end only, while the other end is unsupported. Unistrut brackets are examples of cantilever beams.

**DEFLECTION**

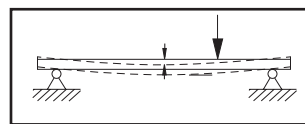

All beams deflect under load. The amount of deflection is dependent on

- (a) the amount of load,
- (b) the support conditions,
- (c) the stiffness of the beam's cross-sectional shape, and
- (d) the stiffness of the beam material.

The stiffness of the beam's cross-sectional shape is measured by its "Moment Of Inertia" or "I". The larger a beam's "I", the stiffer it is and the less it will deflect. A beam's "I" can change for each major axis. The "I" of both major axes (I 1-1 and I 2-2) are provided.

The stiffness of a beam's material is measured by its "Modulus of Elasticity" or "E". The larger a material's "E", the stiffer it is and the less it deflects. For example, steel is about three times stiffer than aluminum and as a result, deflects only one-third as much. Do not confuse stiffness with strength. Two materials may have identical strengths yet still have different "E's". A high-strength aluminum may be as strong as steel and still deflect three times as much.

The load charts and tables give calculated deflections for the loads shown. In many cases, a final design will be determined by the maximum deflection, not the maximum load.

**BENDING MOMENT**

Is it strong enough? This is the final consideration for any beam. A beam must not only hold up the anticipated loads, but must also have sufficient additional capacity to safely hold unforeseen variations in applied loads and material strengths. This additional capacity is called a safety factor and is usually regulated by the various design codes and standards. A beam's strength is usually measured by an allowable bending moment or an allowable stress. The traditional approach is the allowable stress method, where a beam is determined to have a maximum allowable stress (in pounds per square inch) which is not to be exceeded.

The approach of the current AISI "Specification For The Design Of Cold-Formed Steel Structural Members" is to use a maximum allowable bending moment (in inch-pounds) which is not to be exceeded. Bending moment divided by a beam's section modulus or "S" equals stress.

COLUMNS

Columns are structural members that are loaded parallel to their length. Most columns are vertical and are used to carry loads from a higher level to a lower level. However any member subjected to compression loads, such as a diagonal or prop brace, is a column.

A column fails by “buckling”, which is a sudden loss of straightness and subsequent collapse. Allowable column load is dependent on:

- (a) the length of column,
- (b) the type of loading,
- (c) the support conditions, and
- (d) the column’s cross-sectional shape and material.

**COLUMN LENGTH**

The column length is measured from braced point to braced point. A braced point is where the column is restrained from lateral movement (translation) in all directions.

**COLUMN LOADING – CONCENTRIC LOADING**

Loads applied to the center of gravity of the column cross-section are considered concentric. A beam that passes over and rests on the top of a column is an example of concentric loading.

**COLUMN LOADING – ECCENTRIC LOADING**

Any load which is not concentric is eccentric. The amount of eccentricity (in inches) has a major effect on the load-carrying capacity of any particular column. A load that is transmitted to a Unistrut Metal Framing column using a standard fitting bolted to the slot face is considered eccentric.

The load tables give allowable loads for both concentric (loaded at C.G.) and certain eccentric (loaded at slot face) loading. Allowable loads for other eccentric loading must be determined by a qualified design professional.

**SUPPORT CONDITIONS**

Based on the support conditions, an appropriate “K” value is selected. This “K” value, which mathematically describes the column end conditions, is used in the column design equations. The most common support condition combinations are as follows:

**SUPPORT CONDITIONS – FIXED TOP – FIXED BOTTOM**

Both ends are restrained against rotation and lateral movement (translation).

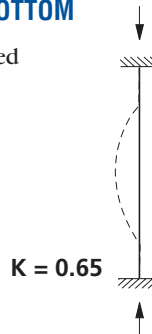

**SUPPORT CONDITIONS – PINNED TOP – FIXED BOTTOM**

The top is restrained against lateral movement (translation) but is allowed to rotate. The bottom is restrained against rotation and lateral movement.

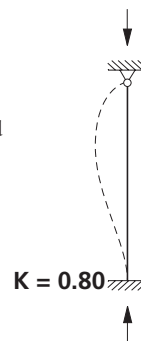

This is a common support condition and is used to construct the allowable column load applied at the Slot Face tables.

**SUPPORT CONDITIONS – PINNED TOP – PINNED BOTTOM**

Both ends are restrained against lateral movement (translation) but, are allowed to rotate.



**SUPPORT CONDITIONS – FIXED / FREE TOP – FIXED BOTTOM**

The top is restrained against rotation but is allowed to move laterally. The bottom is restrained against rotation and lateral movement (translation).

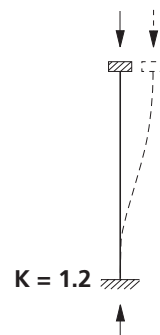

**CROSS-SECTIONAL SHAPE**

The cross-sectional shape of a column member determines the value of its “Radius of Gyration” or “r”. In general, a member with a large “r” makes a better column than a member with a small “r”. Each axis of a column has a different “r”. Typically the axis with the smallest “r” determines the final design.

**BOLT TORQUE**

Bolt torque values are given to ensure the proper connection between Unistrut Metal Framing components. It is important to understand that there is a direct, but not necessarily consistent, relationship between bolt torque and tension in the bolt. Too much tension in the bolt can cause it to break or crush the component parts. Too little tension in the bolt can prevent the connection from developing its full load capacity. The torque values given have been developed over many years of experience and testing.

Bolt Torque						
BOLT SIZE	1/4" -20	5/16" -18	3/8" -16	1/2" -13	5/8" -11	3/4" -10
Rec. Torque Ft/Lbs (N·m)	6 (8)	11 (15)	19 (26)	50 (68)	100 (136)	125 (170)
Max Torque Ft/Lbs (N·m)	7 (9)	15 (20)	25 (34)	70 (95)	125 (170)	135 (183)

These are based on using a properly calibrated torque wrench with a clean dry (non-lubricated) Unistrut fitting, bolt and nut. A lubricated bolt or nut can cause extremely high tension in the connection and may lead to bolt failure. It must be noted that the accuracy of commercial torque wrenches varies widely and it is the responsibility of the installer to ensure that proper bolt torque has been achieved.



**UNIT CONVERSIONS**





To Convert From	English To Metric To	Multiply By
<b>Length</b>		
Inch [in]	Millimeter [mm]	25.400 000
Foot [ft]	Meter [m]	0.304 800
Yard [yd]	Meter [m]	0.914 400
Mile [mi] (U.S. Statute)	Kilometer [km]	1.609 347
<b>Area</b>		
Square Inch [in <sup>2</sup> ]	Square Millimeter [mm <sup>2</sup> ]	645.16
Square Foot [ft <sup>2</sup> ]	Square Meter [m <sup>2</sup> ]	0.092 903
Square Yard [yd <sup>2</sup> ]	Square Meter [m <sup>2</sup> ]	0.836 127
Square Mile [mi <sup>2</sup> ] (U.S. Statute)	Square Kilometer [km <sup>2</sup> ]	2.589 998
Acre	Square Meter [m <sup>2</sup> ]	4046.873
Acre	Hectare	0.404 687
<b>Volume</b>		
Cubic Inch [in <sup>3</sup> ]	Cubic Millimeter [mm <sup>3</sup> ]	16387.06
Cubic Foot [ft <sup>3</sup> ]	Cubic Meter [m <sup>3</sup> ]	0.028 317
Cubic Yard [yd <sup>3</sup> ]	Cubic Meter [m <sup>3</sup> ]	0.764 555
Gallon [gal] (U.S. Liquid)	Litre [l]	3.785 412
Quart [qt] (U.S. Liquid)	Litre [l]	0.946 353
<b>Mass</b>		
Ounce (Avoirdupois) [oz]	Gram [g]	28.349 520
Pound (Avoirdupois) [lb]	Kilogram [kg]	0.453 592
Short Ton	Kilogram [kg]	907.185
<b>Force</b>		
Ounce-Force	Newton [N]	0.278 014
Pound-Force [lbf]	Newton [N]	4.448 222
<b>Bending Moment</b>		
Pound-Force-Inch [lbf-in]	Newton-Meter [N-m]	0.112 985
Pound-Force-Foot [lbf-ft]	Newton-Meter [N-m]	1.355 818
<b>Pressure, Stress</b>		
Pound-Force per Square Inch [lbf/in <sup>2</sup> ]	Kilopascal [kPa]	6.894 757
Foot of Water (39.2 F)	Kilopascal [kPa]	2.988 980
Inch of Mercury (32 F)	Kilopascal [kPa]	3.386 380
<b>Energy, Work, Heat</b>		
Foot-Pound-Force [ft-lbf]	Joule [J]	1.355 818
British Thermal Unit [Btu]	Joule [J]	1055.056
Calorie [cal]	Joule [J]	4.186 800
Kilowatt Hour [kW-h]	Joule [J]	3,600,000
<b>Power</b>		
Foot-Pound-Force /Second [ft-lbs/s]	Watt [W]	1.355 818
British Thermal Unit /Hour [Btu/h]	Watt [W]	0.293 071
Horsepower [hp] (550 Ft. Lbf/s)	Kilowatt [kW]	0.745 700
<b>Angle</b>		
Degree	Radian [rad]	0.017 453
<b>Temperature</b>		
Degree Fahrenheit [°F]	Degree Celsius [°C]	(F° -32)/1.8

To Convert From	Metric to English To	Multiply By
<b>Length</b>		
Millimeter [mm]	Inch [in]	0.039 370
Meter [m]	Foot [ft]	3.280 840
Meter [m]	Yard [yd]	1.093 613
Kilometer [km]	Mile [mi] (U.S. Statute)	0.621 370
<b>Area</b>		
Square Millimeter [mm <sup>2</sup> ]	Square Inch [in <sup>2</sup> ]	0.001550
Square Meter [m <sup>2</sup> ]	Square Foot [ft <sup>2</sup> ]	10.763 915
Square Meter [m <sup>2</sup> ]	Square Yard [yd <sup>2</sup> ]	1.195 991
Square Kilometer [km <sup>2</sup> ]	Square Mile [mi <sup>2</sup> ] (U.S. Statute)	0.386 101
Square Meter [m <sup>2</sup> ]	Acre	0.000 247
Hectare	Acre	2.471 046
<b>Volume</b>		
Cubic Millimeter [mm <sup>3</sup> ]	Cubic Inch [in <sup>3</sup> ]	0.000061
Cubic Meter [m <sup>3</sup> ]	Cubic Foot [ft <sup>3</sup> ]	35.314 662
Cubic Meter [m <sup>3</sup> ]	Cubic Yard [yd <sup>3</sup> ]	1.307 950
Litre [l]	Gallon [gal] (U.S. Liquid)	0.264 172
Litre [l]	Quart [qt] (U.S. Liquid)	1.056 688
<b>Mass</b>		
Gram [g]	Ounce (Avoirdupois) [oz]	0.035 274
Kilogram [kg]	Pound (Avoirdupois) [lb]	2.204 624
Kilogram [kg]	Short Ton	0.00110
<b>Force</b>		
Newton [N]	Ounce-Force	3.596 941
Newton [N]	Pound-Force [lbf]	0.224 809
<b>Bending Moment</b>		
Newton-Meter [N-m]	Pound-Force-Inch [lbf-in]	8.850 732
Newton-Meter [N-m]	Pound-Force-Foot [lbf-ft]	0.737 562
<b>Pressure, Stress</b>		
Kilopascal [kPa]	Pound-Force per Square Inch [lbf/in <sup>2</sup> ]	0.145 038
Kilopascal [kPa]	Foot of Water (39.2 F)	0.334 562
Kilopascal [kPa]	Inch of Mercury (32 F)	0.295 301
<b>Energy, Work, Heat</b>		
Joule [J]	Foot-Pound-Force [ft-lbf]	0.737 562
Joule [J]	British Thermal Unit [Btu]	0.000948
Joule [J]	Calorie [cal]	0.238 846
Joule [J]	Kilowatt Hour [kW-h]	2.78 <sup>-7</sup>
<b>Power</b>		
Watt [W]	Foot-Pound-Force /Second [ft-lbs/s]	0.737 562
Watt [W]	British Thermal Unit /Hour [Btu/h]	3.412 142
Kilowatt [kW]	Horsepower (550 Ft. Lbf/s) [hp]	1.341 022
<b>Angle</b>		
Radian [rad]	Degree	57.295 788
<b>Temperature</b>		
Degree Celsius [°C]	Degree Fahrenheit [°F]	1.8xC°+32



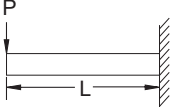

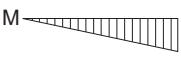
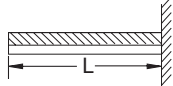
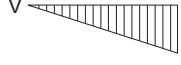
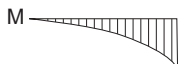
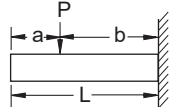

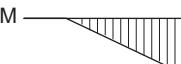
BEAM SUPPORT CONDITIONS



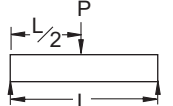

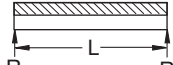

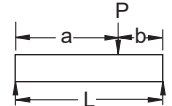
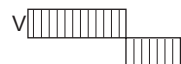
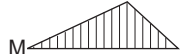

### Cantilever Beams

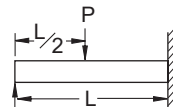
 <p> <math>V_{max.} = P</math>  <math>M_{max.} = PL</math>  <math>\Delta_{max.} = \frac{PL^3}{3EI}</math> </p>  	 <p> <math>V_{max.} = W</math>  <math>M_{max.} = \frac{WL}{2}</math>  <math>\Delta_{max.} = \frac{WL^3}{8EI}</math> </p>  	 <p> <math>V_{max.} = P</math>  <math>M_{max.} = Pb</math>  <math>\Delta_{max.} = \frac{Pb^2(3L-b)}{6EI}</math> </p>  
---	---	---





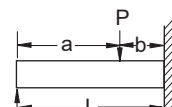
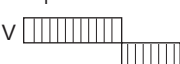

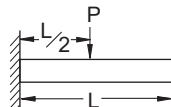

### Simple Beams

 <p> <math>R = \frac{P}{2}</math>  <math>V_{max.} = \frac{P}{2}</math>  <math>M_{max.} = \frac{PL}{4}</math>  <math>\Delta_{max.} = \frac{PL^3}{48EI}</math> </p>  	 <p> <math>R = \frac{W}{2}</math>  <math>V_{max.} = \frac{W}{2}</math>  <math>M_{max.} = \frac{WL}{8}</math>  <math>\Delta_{max.} = \frac{5WL^3}{384EI}</math> </p>  	 <p> <math>R_1 = \frac{Pb}{L}</math>  <math>R_2 = \frac{Pa}{L}</math>  <math>V_{max.} = \frac{Pa}{L}</math>  <math>M_{max.} = \frac{Pab}{L}</math>  <math>\Delta_{max.} = \frac{Pab(a+2b)}{27EI} \sqrt{\frac{3a(a+2b)}{27EI}}</math> </p>  
--	--	---

### Beams Fixed At One End & Supported At The Other

 <p> <math>R_1 = \frac{5P}{16}</math>  <math>V_{max.} = \frac{11P}{16}</math>  <math>M_{max.} = \frac{3PL}{16}</math>  <math>\Delta_{max.} \text{ at } x = 0.447L</math>  <math>\Delta_{max.} = 0.009317 \frac{PL^3}{EI}</math> </p>  	 <p> <math>R_1 = \frac{3W}{8}</math>  <math>V_{max.} = \frac{5W}{8}</math>  <math>M_{max.} = \frac{WL}{8}</math>  <math>\Delta_{max.} \text{ at } x = 0.4215L</math>  <math>\Delta_{max.} = \frac{WL^3}{185EI}</math> </p>  	 <p> <math>R_1 = \frac{Pb^2}{2L^3}(a+2L)</math>  <math>R_2 = \frac{Pa}{2L^3}(3L^2-a^2)</math>  <math>M \text{ at point of load} = R_1 a</math>  <math>M \text{ at fixed end} = \frac{Pab}{2L^3}(a+L)</math> </p>  
---	---	---

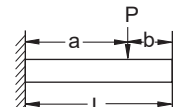
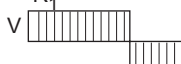
### Beams Fixed At Both Ends

 <p> <math>V_{max.} = \frac{P}{2}</math>  <math>M_{max.} = \frac{PL}{8}</math>  <math>\Delta_{max.} = \frac{PL^3}{192EI}</math> </p>  	 <p> <math>V_{max.} = \frac{W}{2}</math>  <math>M_{max.} = \frac{WL}{12}</math>  <math>\Delta_{max.} = \frac{WL^3}{384EI}</math> </p>  	 <p> <math>R_1 = \frac{Pb^2}{L^3}(3a+b)</math>  <math>R_2 = \frac{Pa^2}{L^3}(a+3b)</math>  <math>M_1 = \frac{Pab^2}{L^2}</math>  <math>M_2 = \frac{Pa^2b}{L^2}</math> </p>  
---	--	---

R – Reaction  
 M – Moment  
 P – Concentrated Load







W – Total Uniform Load  
 V – Shear  
 L – Length

$\Delta$  – Deflection  
 E – Modulus of Elasticity  
 I – Moment of Inertia

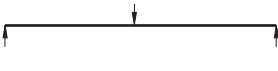
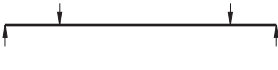
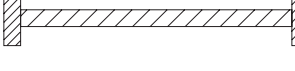

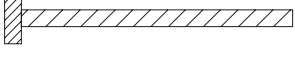
**CONVERSION FACTORS FOR BEAMS WITH VARIOUS STATIC LOADING CONDITIONS**

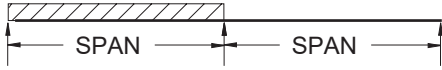
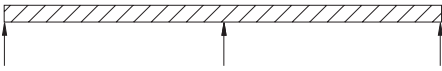
All Beam Load tables are for single-span (simple) beams supported at the ends. These can be used in the majority of the cases. However, there are times when it is necessary to know what happens with other loading and support conditions. Some common arrangements are shown below. Simply multiply the values from the Beam Load tables by factors given below

Load and Support Condition		Load Factor	Deflection Factor
1. Simple Beam, Uniform Load		1.00	1.00
2. Simple Beam, Concentrated Load at Center		.50	.80
3. Simple Beam, Two Equal Concentrated Loads at 1/4 pts		1.00	1.10
4. Beam Fixed at Both Ends, Uniform Load		1.50	.30
5. Beam Fixed at Both Ends, Concentrated Load at Center		1.00	.40
6. Cantilever Beam, Uniform Load		.25	2.40
7. Cantilever Beam, Concentrated Load at End		.12	3.20
8. Continuous Beam, Two Equal Spans, Uniform Load on One Span		1.30	.92
9. Continuous Beam, Two Equal Spans, Uniform Load on Both Ends		1.00	.42
10. Continuous Beam, Two Equal Spans, Concentrated Load at Center of One Span		.62	.71
11. Continuous Beam, Two Equal Spans, Concentrated Load at Center of Each Span		.67	.48

**EXAMPLE I:**

Determine load and deflection of a P 1000 beam continuous over one support and loaded uniformly on one span.

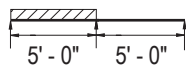

**SOLUTION:**

- A. From load table for P1000 on page 25 load for a 5'-0" span is 680# and deflection is .35".
- B. Multiply by factors from Table above.  
Load = 680# x 1.30 = 884#  
Deflection = .35" x .92 = .32"

**EXAMPLE II**

Determine load and deflection of a P 5500 cantilever beam with a concentrated load on the end.

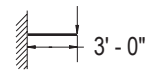

**SOLUTION:**

- A. From load table P5500 on page 58 load for a 3'-0" span is 2180# and deflection is .09".
- B. Multiply by factors from Table above.  
Load = 2180# x .12 = 262#  
Deflection = .09" x 3.20 = .29"

**PART I - GENERAL**

**1.01 SCOPE OF WORK**

- A. Provide all Unistrut Metal Framing material, fittings and related accessories (Strut System) as indicated on the Contract Drawings.
- B. Provide all labor, supervision, engineering, and fabrication required for installation of the Strut System in accordance with the Contract Drawings and as specified herein.
- C. Related work specified elsewhere.

**1.02 QUALITY ASSURANCE**

- A. Manufacturer's qualifications:
  - 1. The manufacturer shall not have had less than 10 year's experience in manufacturing Strut Systems.
  - 2. The manufacturer must certify in writing all components supplied have been produced in accordance with an established quality assurance program.
- B. Installer's qualifications:
  - 1. Installer must be a Unistrut trained manufacturer's authorized representative/installer with not less than 5 years experience in the installation of Strut Systems of this size and conformation.
  - 2. All Strut System components must be supplied by a single manufacturer.
- C. Standards:
  - 1. Work shall meet the requirements of the following standards:
    - a. Federal, State and Local codes.
    - b. American Iron and Steel Institute (AIS) Specification for the Design of Cold-Formed Steel Structural Members 2007 Edition.
    - c. American Society for Testing And Materials (ASTM).

**1.03 SUBMITTALS**

- A. Structural Calculations and Shop Drawings
  - 1. Submit structural calculations for approval by the project engineer. Calculations may include, but are not limited to:
    - a. Description of design criteria.
    - b. Stress and deflection analysis.
    - c. Selection of Unistrut framing members, fittings, and accessories.
  - 2. Submit all shop/assembly drawings necessary to completely install the Strut System in compliance with the Contract Drawings.
  - 3. Submit all pertinent manufacturer's published data.

**1.04 PRODUCT DELIVERY, STORAGE, AND HANDLING**

- A. All material is to be delivered to the work site in original factory packaging to avoid damage to the finish.
- B. Upon delivery to the work site, all components shall be protected from the elements by a shelter or other covering.

**1.05 GUARANTEE**

- A. Separate guarantees shall be issued from the erector and manufacturer, valid for a period of 1 year, against any defects that may arise from the installation or manufacture of the Strut System components.

**PART 2 - PRODUCTS**

**2.01 ACCEPTABLE MANUFACTURERS**

- A. All Strut System components shall be as manufactured by UNISTRUT CORPORATION or approved equal as determined by the Architect or Engineer of record in writing 10 days prior to bid date.

**2.02 MATERIALS**

- A. All channel members shall be fabricated from structural grade steel conforming to one of the following ASTM specifications: A 1011 SS GR 33, A 653 GR 33.
- B. All fittings shall be fabricated from steel conforming to one of the following ASTM specifications: A 575, A 576, A 36 or A 635.
- C. Substitutions
  - Any substitutions of product or manufacturer must be approved in writing ten days prior to bid date, by Architect or Engineer of record.

**2.03 FINISHES**

- A. Strut System components shall be finished in accordance with one of the following standards:
  - 1. PERMA-GREEN® III (GR)
    - Rust inhibiting epoxy enamel paint applied by electro-deposition, after cleaning and phosphating, and thoroughly baked. Color is per Federal Highway Green, Color Tolerance Chart PR Color No. 4. Finish to withstand minimum 400 hours salt spray when tested in accordance with ASTM B117.
  - 2. ELECTRO-GALVANIZED (EG)
    - Electrolytically zinc coated per ASTM B 633 Type III SC 1

- 3. PRE-GALVANIZED (PG)
  - Zinc coated by hot-dipped process prior to roll forming. The zinc weight shall be G90 conforming to ASTM A 653.
- 4. HOT-DIPPED GALVANIZED (HG)
  - Zinc coated after all manufacturing operations are complete. Coating shall conform to ASTM A 123 or A 153.
- 5. UNISTRUT DEFENDER™ (DF)
  - Coating conforming to ASTM A1046 or A1059.
- 6. SPECIAL COATING / MATERIAL
  - (Describe as applicable)

**PART 3 - EXECUTION**

**3.01 EXAMINATION**

- A. The installer shall inspect the work area prior to installation. If work area conditions are unsatisfactory, installation shall not proceed until satisfactory corrections are completed.

**3.02 INSTALLATION**

- A. Installation shall be accomplished by a fully trained manufacturer authorized installer.
- B. Set Strut System components into final position true to line, level and plumb, in accordance with approved shop drawings.
- C. Anchor material firmly in place. Tighten all connections to their recommended torques.

**3.03 CLEANUP**

- A. Upon completion of this section of work, remove all protective wraps and debris. Repair any damage due to installation of this section of work.

**3.04 PROTECTION**

- A. During installation, it shall be the responsibility of the installer to protect this work from damage.
- B. Upon completion of this scope of work, it shall become the responsibility of the general contractor to protect this work from damage during the remainder of construction on the project and until substantial completion.



**UNIPIER® ROOFTOP PIPE SUPPORT SYSTEM**

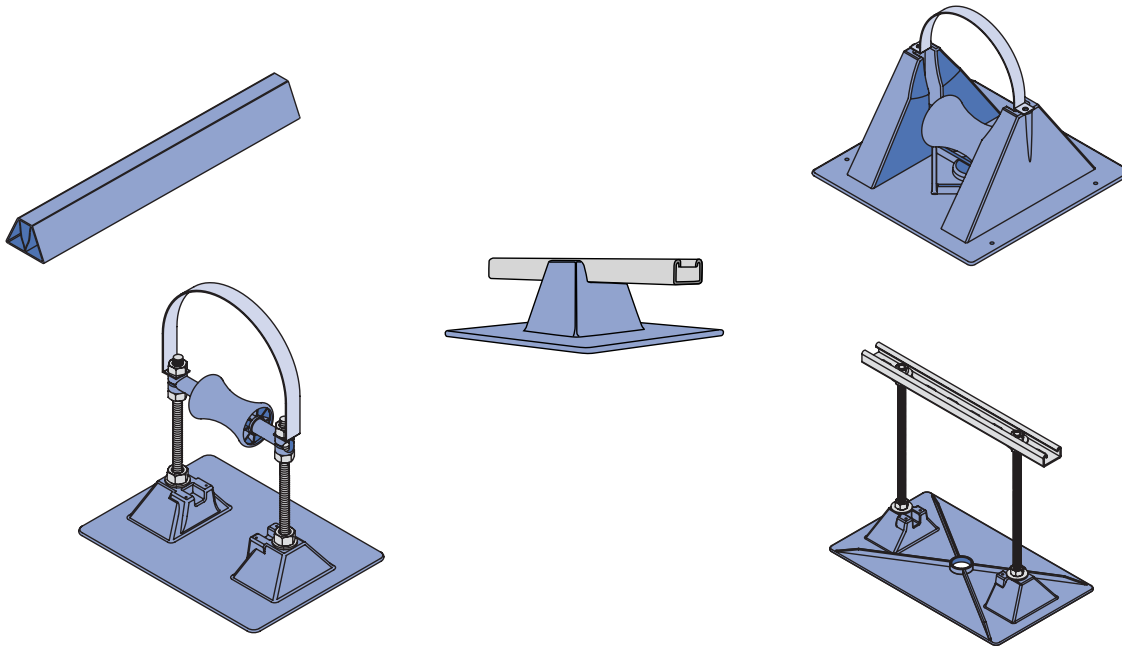

**NEW CHANNEL SECTION P4520/P4521 (1<sup>5</sup>/<sub>8</sub>" x 1<sup>3</sup>/<sub>16</sub>")**

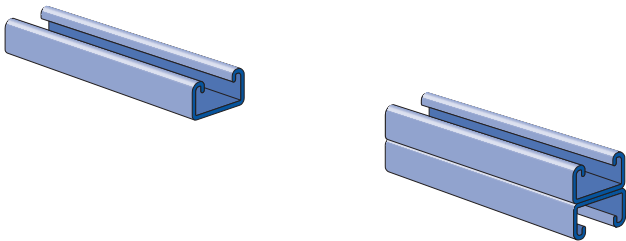

**NEW CHANNEL SECTION P4400/P4401 (1<sup>5</sup>/<sub>8</sub>" x 1")**

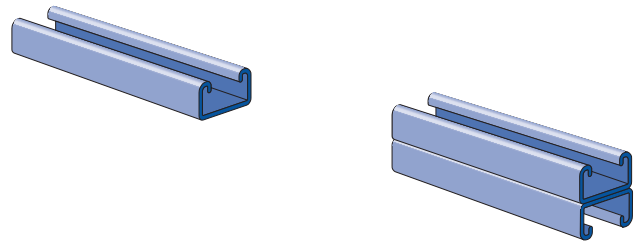

**NEW BEAM CLAMP P1640**

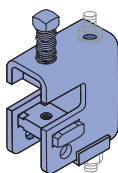

# 1<sup>5</sup>/<sub>8</sub>" CHANNEL

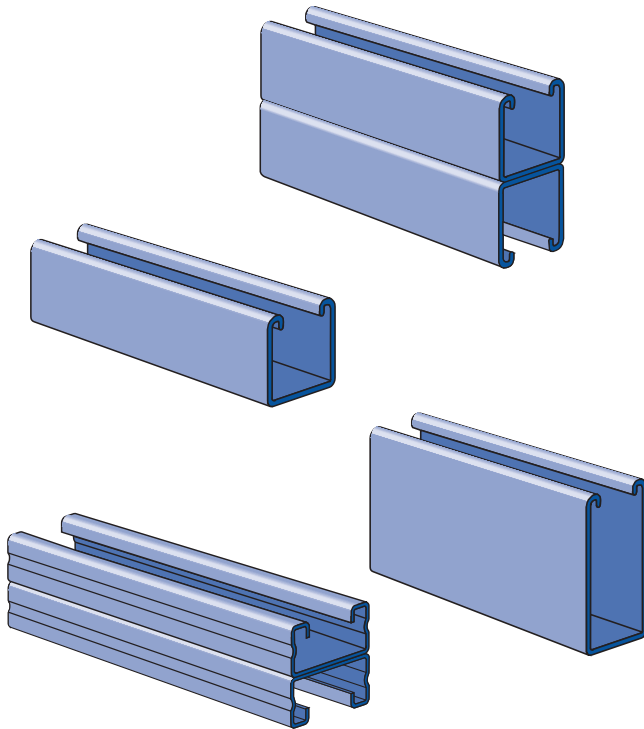

Channel Selection Chart .....	23
P1000 (12 Gauge) .....	24 - 29
P1100 (14 Gauge) .....	30 - 32
P2000 (16 Gauge) .....	33 - 35
P3000 (12 Gauge) .....	36 - 38
P3300 (12 Gauge) .....	39 - 41
P4000 (16 Gauge) .....	42 - 44
P4100 (14 Gauge) .....	45 - 47
P4400 (12 Gauge) .....	48 - 50
P4520 (12 Gauge) .....	51 - 53
P5000 (12 Gauge) .....	54 - 56
P5500 (12 Gauge) .....	57 - 59
Closure Strips .....	60
End Caps and Frame Caps .....	61
Lateral Bracing Load Reduction Chart & Bearing Loads.....	62

## MATERIAL

Unistrut channels are accurately and carefully cold formed to size from low-carbon strip steel.

All spot-welded combination members, except P1001T, are welded 3" (76 mm) maximum on center.

### STEEL: PLAIN

12 Ga. (2.7 mm), 14 Ga.(1.9 mm) and  
16 Ga. (1.5 mm) ASTM A1011 SS GR 33

### STEEL: PRE-GALVANIZED

12 Ga. (2.7 mm), 14 Ga. (1.9 mm) and  
16 Ga. (1.5mm) ASTM A653 GR 33

For other materials, see Special Metals or Fiberglass sections.

## FINISHES

All channels are available in:

- Perma Green III (GR)
- Pre-galvanized (PG), conforming to ASTM A653 G90
- Hot-dipped galvanized (HG), conforming to ASTM A123
- Plain (PL)
- Unistrut Defender™ (DF), conforming to ASTM A1046

## DIMENSIONS

Imperial dimensions are illustrated in inches. Metric dimensions are shown in millimeters and rounded to one decimal place.

## STANDARD LENGTHS

Standard lengths are 10 feet (3.05m) and 20 feet (6.10m). Tolerances are ±1/8" (3 mm). Special lengths are available for a small cutting charge with a tolerance of ±1/8" (3 mm).

## CURVED CHANNEL

Contact your local Unistrut Service Center or Unistrut Corporation for more information.

## LOAD DATA

All beam and column load data pertains to carbon steel and stainless steel channels. Load tables and charts are constructed to be in accordance with the SPECIFICATION FOR THE DESIGN OF COLD-FORMED STEEL STRUCTURAL MEMBERS 2007 EDITION published by the AMERICAN IRON AND STEEL INSTITUTE USING ASD METHOD. Loads are based on 33 ksi steel cold formed to 42 ksi.

Type of Load	Safety Factor to Yield Strength
Beam Loads	1.67
Column Load	1.80



1 1/8" Channel

Telestrut

Nuts & Hardware

General Fittings

Pipe/Conduit Supports

Electrical Fittings

Concrete Inserts

Solar

Unipier®

**P1000 Series (12 ga.)**

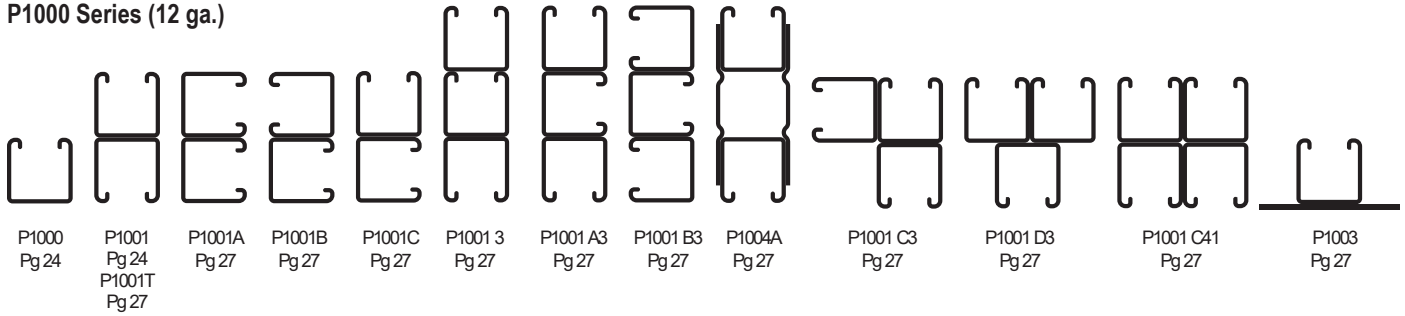

**P1100 Series (14 ga.)**

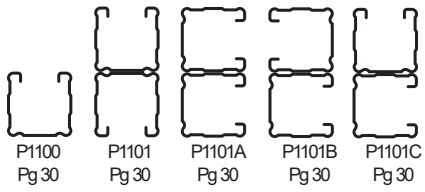

**P2000 Series (16 ga.)**

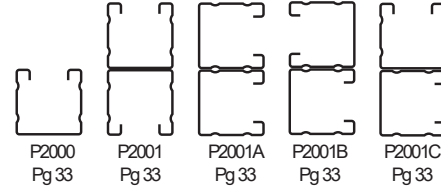

**P3000 Series (12 ga.)**

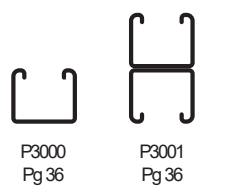

**P3300 Series (12 ga.)**

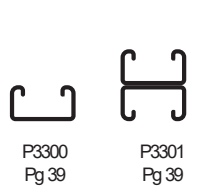

**P4100 Series (14 ga.)**

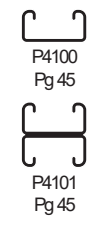

**P4000 Series (16 ga.)**

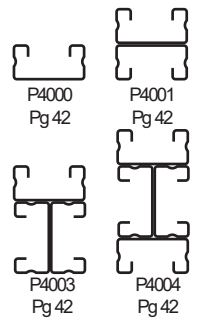

**P4400 Series (12 ga.)**



**P4520 Series (12 ga.)**



**P5000 Series (12 ga.)**

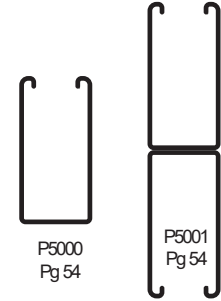

**P5500 Series (12 ga.)**

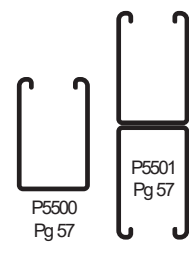

**P9000 Series (12 ga.) Telestrut Channel**



**End Caps and Frame Caps**

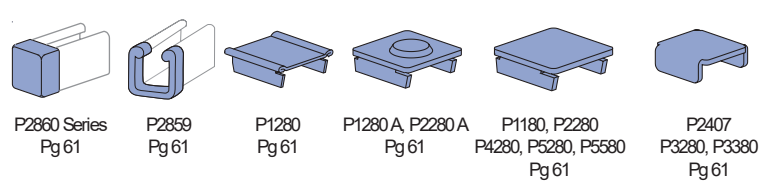

**1 1/8" Channel Closure Strips**

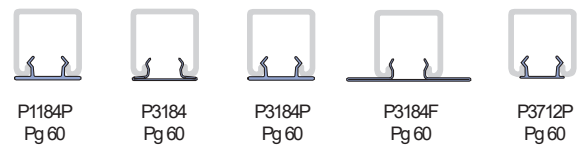

**Alternate Framing Systems**

**A1000 Series (14 gauge) – 1 1/4" Channel**

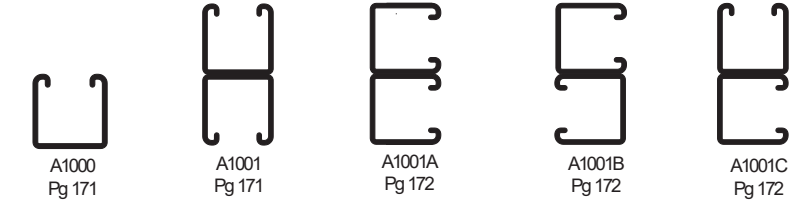

**A3300 Series (14 gauge) 1 1/4" Channel**



**P6000 Series (19 gauge) – 1 3/16" Channel**

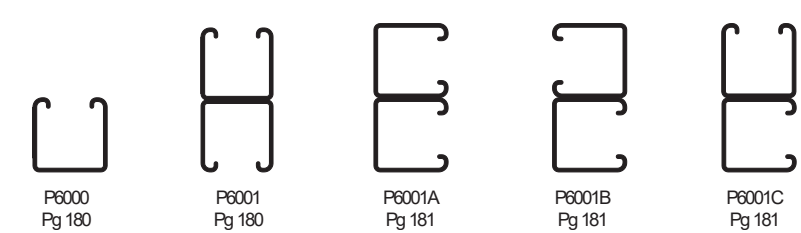

**P7000 Series (19 gauge) 1 3/16" Channel**

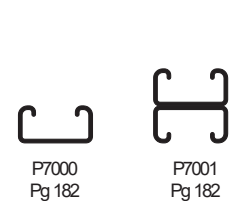

# Channel Selection

## CHANNEL SELECTION CHART

Channel	Channel Dimensions		Material & Thickness			Hole Pattern Styles						
			Steel gauge	Stainless Steel gauge	Alum. In (mm)							
	In (mm)	In (mm)				HS	T	WT	Steel Only			
P1000	1½ (41.3)	1½ (41.3)	12 ga	12 ga	0.109 (2.8)	■	■	■	■	■	■	■
P1100	1½ (41.3)	1½ (41.3)	14 ga	14 ga	—	■	■	■	■	■	—	—
P2000	1½ (41.3)	1½ (41.3)	16 ga	—	—	■	■	■	■	■	—	—
P3000	1½ (41.3)	1¾ (34.9)	12 ga	—	—	■	■	■	■	■	—	—
P3300	1½ (41.3)	7⁄8 (22.2)	12 ga	12 ga	—	■	■	■	—	■	—	—
P4000	1½ (41.3)	1⅜ (20.6)	16 ga	16 ga	0.078 (2.0)	■	■	■	—	■	—	—
P4100	1½ (41.3)	1⅜ (20.6)	14 ga	—	—	■	■	■	—	■	—	—
P4400	1½ (41.3)	1 (25.4)	12 ga	—	—	■	■	■	—	■	—	—
P4520	1½ (41.3)	1⅜ (20.6)	12 ga	—	—	■	■	■	—	■	—	—
P5000	1½ (41.3)	3⁄4 (82.6)	12 ga	12 ga	—	■	■	■	■	■	—	—
P5500	1½ (41.3)	2⅞ (61.9)	12 ga	—	0.109 (2.8)	■	■	■	■	■	—	—

## CHANNELS & COMBINATIONS IN DESCENDING ORDER OF STRENGTH

Channel	Area In <sup>2</sup> (cm <sup>2</sup> )	Weight lbs/ft (kg/m)	I In <sup>4</sup> (cm <sup>4</sup> )	s In <sup>3</sup> (cm <sup>3</sup> )	Allow. Moment In-lbs (N·m)
P5001	1.793	6.10	6.227	1.916	48,180
	11.57	9.1	259.2	31.4	5,440
P1004A	1.965	6.68	4.068	1.669	41,980
	12.68	9.9	169.3	27.4	4,740
P5501	1.452	4.94	2.805	1.151	28,940
	9.37	7.3	116.8	18.9	3,270
P1001C41	2.221	7.55	1.856	1.142	28,720
	14.33	11.2	77.2	18.7	3,250
P5000	0.897	3.05	1.098	0.627	15,770
	5.78	4.5	45.7	10.3	1,780
P1001	1.111	3.78	0.928	0.571	14,360
	7.16	5.6	38.6	9.4	1,620
P1101	0.835	2.84	0.733	0.451	11,340
	5.39	4.2	30.5	7.4	1,280
P3001	1.000	3.40	0.591	0.430	10,810
	6.45	5.1	24.6	7.0	1,220
P5500	0.726	2.47	0.522	0.390	9,820
	4.68	3.7	21.7	6.4	1,110
P2001	0.684	2.32	0.618	0.381	9,570
	4.41	3.5	25.7	6.2	1,080
P9200	0.489	2.23	0.279	0.297	7,480
	3.16	3.3	11.6	4.9	850
P4401	0.849	5.77	0.26	0.26	6,410
	5.48	8.5	10.6	4.2	725
A1001	0.609	2.07	0.302	0.242	6,070
	3.93	3.1	12.6	4.0	690
P9000	0.387	1.88	0.166	0.205	5,150
	2.50	2.8	6.9	3.4	580
P1000	0.555	1.89	0.185	0.202	5,070
	3.58	2.8	7.7	3.3	570
P3301	0.790	2.69	0.176	0.201	5,060
	5.10	4.0	7.3	3.3	570
P4521	0.77	2.62	0.15	0.18	4,538
	4.97	3.9	6.1	2.9	513

Channel	Area In <sup>2</sup> (cm <sup>2</sup> )	Weight lbs/ft (kg/m)	I In <sup>4</sup> (cm <sup>4</sup> )	s In <sup>3</sup> (cm <sup>3</sup> )	Allow. Moment In-lbs (N·m)
P1100	0.418	1.42	0.145	0.162	4,060
	2.69	2.1	6.0	2.6	460
P3000	0.500	1.70	0.120	0.153	3,850
	3.23	2.5	5.0	2.5	430
P4101	0.579	1.97	0.117	0.143	3,610
	3.74	2.9	4.9	2.4	410
P2000	0.342	1.16	0.125	0.140	3,520
	2.21	1.7	5.2	2.3	400
P4001	0.478	1.66	0.104	0.128	3,210
	3.14	2.5	4.3	2.1	360
A3301	0.459	1.56	0.077	0.103	2,590
	2.96	2.3	3.2	1.7	290
P4400	0.424	2.89	0.053	0.092	2,300
	2.74	4.3	2.2	1.5	260
A1000	0.305	1.04	0.061	0.086	2,170
	1.96	1.5	2.5	1.4	250
P3300	0.395	1.34	0.037	0.072	1,800
	2.55	2.0	1.5	1.2	200
P4520	0.384	1.31	0.031	0.064	1,615
	2.48	1.9	1.3	1.0	183
A4001	0.264	0.90	0.037	0.058	1,470
	1.70	1.3	1.5	1.0	170
P6001	0.213	0.73	0.045	0.055	1,400
	1.38	1.1	1.9	0.9	160
P4100	0.290	0.98	0.026	0.054	1,360
	1.87	1.5	1.1	0.9	150
P4000	0.244	0.83	0.023	0.049	1,230
	1.57	1.2	0.9	0.8	140
A3300	0.230	0.78	0.017	0.038	950
	1.48	1.2	0.7	0.6	110
P6000	0.107	0.36	0.009	0.020	510
	0.69	0.5	0.4	0.3	60
P7001	0.148	0.50	0.007	0.018	460
	0.96	0.8	0.3	0.3	50
P7000	0.074	0.25	0.002	0.007	170
	0.48	0.4	0.1	0.1	20

Combinations not shown in catalog are available on special order. Consult factory for more details.



1 1/8" Channel

Telestrut

Nuts & Hardware

General Fittings

Pipe/Conduit Supports

Electrical Fittings

Concrete Inserts

Solar

Unipier®

**P1000®**

DF GR HG PG PL

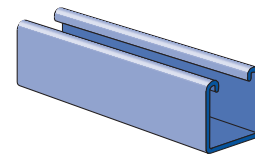
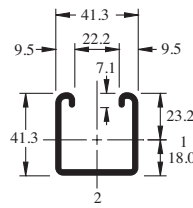
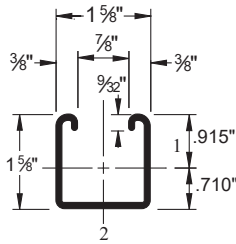

W/100 Ft: 189 Lbs (281 kg/100 m)  
Allowable Moment 5,070 In-Lbs (570 N\*m)  
12 Gauge Nominal Thickness .105" (2.7mm)

**P1001**

DF GR HG PG PL

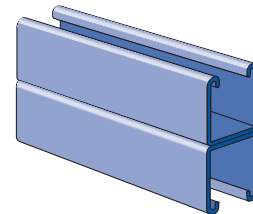
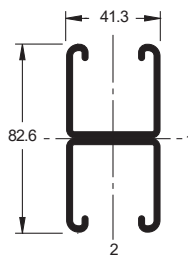
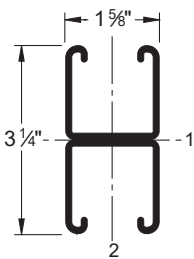

W/100 Ft: 378 Lbs (562 kg/100 m)  
Allowable Moment 14,360 In-Lbs (1,620 N\*m)  
12 Gauge Nominal Thickness .105" (2.7mm)

**P1000 DS**

**P1000 H3** GR HG PG PL

**P1000 HS** GR HG PG PL

**P1000 KO** GR PG

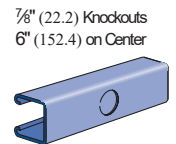
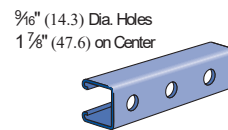
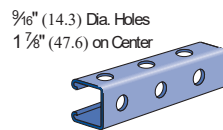
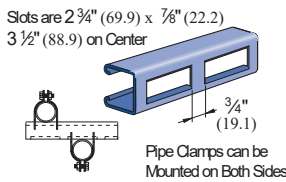

W/100 Ft: 173 Lbs (257 kg/100 m)

W/100 Ft: 175 Lbs (260 kg/100 m)

W/100 Ft: 190 Lbs (283 kg/100 m)

W/100 Ft: 185 Lbs (275 kg/100 m)

**P1000 SL** GR HG PG PL

**P1000 T** DF GR HG PG PL

**P1000 WT** DF GR HG PG PL

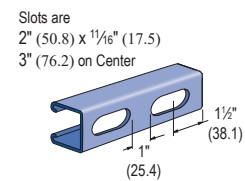
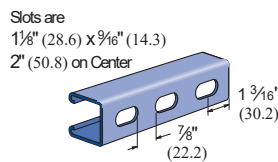
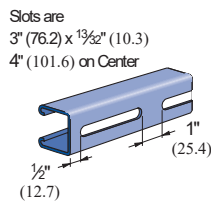

W/100 Ft: 185 Lbs (275 kg/100 m)

W/100 Ft: 185 Lbs (275 kg/100 m)

W/100 Ft: 185 Lbs (275 kg/100 m)

**CHANNEL NUTS** (REFER TO PAGES 73,74 FOR DETAILS)

SEE PAGE 73, 74

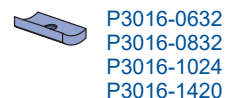
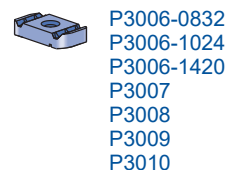
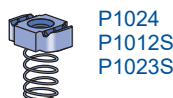
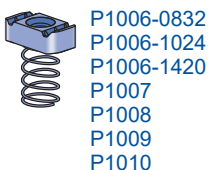

Channel Finishes: DF, PL, GR, HG, PG, ZD; Standard Lengths: 10' & 20'



# P1000 & P1001 Channels

## P1000 - BEAM LOADING

Span In	Max. Allowable Uniform Load Lbs	Defl. at Uniform Load In	Uniform Loading at Deflection		
			Span/180 Lbs	Span/240 Lbs	Span/360 Lbs
24	1,690	0.06	1,690	1,690	1,690
36	1,130	0.13	1,130	1,130	900
48	850	0.22	850	760	500
60	680	0.35	650	480	320
72	560	0.50	450	340	220
84	480	0.68	330	250	160
96	420	0.89	250	190	130
108	380	1.14	200	150	100
120	340	1.40	160	120	80
144	280	2.00	110	80	60
168	240	2.72	80	60	40
192	210	3.55	60	50	NR
216	190	4.58	50	40	NR
240	170	5.62	40	NR	NR

## P1001 - BEAM LOADING

Span In	Max. Allowable Uniform Load Lbs	Defl. at Uniform Load In	Uniform Loading at Deflection		
			Span/180 Lbs	Span/240 Lbs	Span/360 Lbs
24	3,500*	0.02	3,500*	3,500*	3,500*
36	3,190	0.07	3,190	3,190	3,190
48	2,390	0.13	2,390	2,390	2,390
60	1,910	0.20	1,910	1,910	1,620
72	1,600	0.28	1,600	1,600	1,130
84	1,370	0.39	1,370	1,240	830
96	1,200	0.51	1,200	950	630
108	1,060	0.64	1,000	750	500
120	960	0.79	810	610	410
144	800	1.14	560	420	280
168	680	1.53	410	310	210
192	600	2.02	320	240	160
216	530	2.54	250	190	130
240	480	3.16	200	150	100

## P1000 - COLUMN LOADING

Unbraced Height In	Max. Allowable Load at Slot Face Lbs	Maximum Column Load Applied at C.G.			
		K = 0.65 Lbs	K = 0.80 Lbs	K = 1.0 Lbs	K = 1.2 Lbs
24	3,550	10,740	9,890	8,770	7,740
36	3,190	8,910	7,740	6,390	5,310
48	2,770	7,260	6,010	4,690	3,800
60	2,380	5,910	4,690	3,630	2,960
72	2,080	4,840	3,800	2,960	2,400
84	1,860	4,040	3,200	2,480	1,980
96	1,670	3,480	2,750	2,110	1,660
108	1,510	3,050	2,400	1,810	**
120	1,380	2,700	2,110	**	**
144	1,150	2,180	1,660	**	**

## P1001 - COLUMN LOADING

Unbraced Height In	Max. Allowable Load at Slot Face Lbs	Maximum Column Load Applied at C.G.			
		K = 0.65 Lbs	K = 0.80 Lbs	K = 1.0 Lbs	K = 1.2 Lbs
24	6,430	24,280	23,610	22,700	21,820
36	6,290	22,810	21,820	20,650	19,670
48	6,160	21,410	20,300	18,670	16,160
60	6,000	20,210	18,670	15,520	12,390
72	5,620	18,970	16,160	12,390	8,950
84	5,170	16,950	13,630	9,470	6,580
96	4,690	14,890	11,190	7,250	5,040
108	4,170	12,850	8,950	5,730	3,980
120	3,690	10,900	7,250	4,640	**
144	2,930	7,630	5,040	**	**

## P1000/P1001 - ELEMENTS OF SECTION

Parameter	P1000		P1001	
Area of Section	0.555	In <sup>2</sup>	1.111	In <sup>2</sup>
Axis 1-1				
Moment of Inertia (I)	0.185	In <sup>4</sup>	0.928	In <sup>4</sup>
Section Modulus (S)	0.202	In <sup>3</sup>	0.571	In <sup>3</sup>
Radius of Gyration (r)	0.577	In	0.914	In
Axis 2-2				
Moment of Inertia (I)	0.236	In <sup>4</sup>	0.471	In <sup>4</sup>
Section Modulus (S)	0.290	In <sup>3</sup>	0.580	In <sup>3</sup>
Radius of Gyration (r)	0.651	In	0.651	In

Notes:

\* Load limited by spot weld shear.

\*\* KL/r > 200

NR = Not Recommended.

- Beam loads are given in total uniform load (W Lbs) not uniform load (w lbs/ft or w lbs/in).
- Beam loads are based on a simple span and assumed to be adequately laterally braced. Unbraced spans can reduce beam load carrying capacity. Refer to Page 62 for reduction factors for unbraced lengths.
- For pierced channel, multiply beam loads by the following factor:
 

"KO" Series.....95%	"T" Series.....85%
"HS" Series.....90%	"SL" Series.....85%
"H3" Series.....90%	"DS" Series.....70%
"WT" Series.....85%	
- Deduct channel weight from the beam loads.
- For concentrated midspan point loads, multiply beam loads by 50% and the corresponding deflection by 80%. For other load conditions refer to page 18.
- All beam loads are for bending about Axis 1-1.

1 1/8" Channel  
 Telestrut  
 Nuts & Hardware  
 General Fittings  
 Pipe/Conduit Supports  
 Electrical Fittings  
 Concrete Inserts  
 Solar  
 Unipier®



1 1/8" Channel

Telestrut

Nuts & Hardware

General Fittings

Pipe/Conduit Supports

Electrical Fittings

Concrete Inserts

Solar

Unipier®

**P1000 - BEAM LOADING (METRIC)**

Span mm	Max Allowable Uniform Load kN	Defl. at Uniform Load mm	Uniform Loading at Deflection		
			Span/180 kN	Span/240 kN	Span/360 kN
600	7.6	1	7.6	7.6	7.6
750	6.1	2	6.1	6.1	5.9
1,000	4.6	4	4.6	4.6	3.3
1,250	3.6	6	3.6	3.2	2.1
1,500	3.1	9	3.0	2.2	1.5
1,750	2.6	12	2.2	1.6	1.1
2,000	2.3	15	1.6	1.2	0.8
2,500	1.8	24	1.1	0.8	0.5
3,000	1.5	34	0.8	0.5	0.4
3,500	1.3	46	0.5	0.4	0.3
4,000	1.2	62	0.4	0.3	0.2
4,500	1.0	78	0.3	0.3	0.2
5,000	0.9	97	0.3	0.2	NR
6,000	0.8	136	0.2	NR	NR

**P1001 - BEAM LOADING (METRIC)**

Span mm	Max Allowable Uniform Load kN	Defl. at Uniform Load mm	Uniform Loading at Deflection		
			Span/180 kN	Span/240 kN	Span/360 kN
600	15.6 *	1	15.6 *	15.6 *	15.6 *
750	15.6 *	1	15.6 *	15.6 *	15.6 *
1,000	13.0	2	13.0	13.0	13.0
1,250	10.4	3	10.4	10.4	10.4
1,500	8.7	5	8.7	8.7	7.4
1,750	7.4	7	7.4	7.4	5.5
2,000	6.5	9	6.5	6.3	4.2
2,500	5.2	13	5.2	4.0	2.7
3,000	4.3	19	3.7	2.8	1.9
3,500	3.7	26	2.8	2.0	1.4
4,000	3.2	34	2.1	1.6	1.1
4,500	2.9	44	1.6	1.2	0.8
5,000	2.6	53	1.3	1.0	0.7
6,000	2.2	78	0.9	0.7	0.4

**P1000 - COLUMN LOADING (METRIC)**

Unbraced Height mm	Maximum Allowable Load at Slot Face kN	Maximum Column Load Applied at C.G.			
		K = 0.65 kN	K = 0.80 kN	K = 1.0 kN	K = 1.2 kN
600	15.8	48.0	44.3	39.4	34.8
750	15.2	44.0	39.4	33.8	28.9
1,000	13.7	37.5	32.0	26.1	21.3
1,250	12.1	31.6	26.1	20.3	16.5
1,500	10.7	26.7	21.3	16.5	13.4
1,750	9.6	22.7	17.8	13.8	11.3
2,000	8.7	19.3	15.3	11.9	9.6
2,250	7.9	16.9	13.4	10.4	8.2
2,500	7.2	15.0	11.9	9.1	**
2,750	6.7	13.5	10.6	8.1	**

**P1001 - COLUMN LOADING (METRIC)**

Unbraced Height mm	Maximum Allowable Load at Slot Face kN	Maximum Column Load Applied at C.G.			
		K = 0.65 kN	K = 0.80 kN	K = 1.0 kN	K = 1.2 kN
600	28.6	108.2	105.3	101.3	97.4
750	28.3	105.0	101.3	96.5	92.2
1,000	27.8	99.6	95.0	89.7	83.9
1,250	27.3	94.7	89.7	81.7	70.1
1,500	26.8	90.3	83.9	70.1	56.4
1,750	25.4	86.7	74.8	58.6	43.5
2,000	23.9	79.4	65.5	47.7	33.3
2,250	22.2	71.9	56.4	37.9	26.3
2,500	20.4	64.4	47.7	30.7	21.3
2,750	18.5	56.9	39.6	25.4	17.6

**P1000/P1001 - ELEMENTS OF SECTION (METRIC)**

Parameter	P1000	P1001
Area of Section	3.58 cm <sup>2</sup>	7.16 cm <sup>2</sup>
Axis 1-1		
Moment of Inertia (I)	7.68 cm <sup>4</sup>	38.62 cm <sup>4</sup>
Section Modulus (S)	3.30 cm <sup>3</sup>	9.36 cm <sup>3</sup>
Radius of Gyration (r)	1.46 cm	2.32 cm
Axis 2-2		
Moment of Inertia (I)	9.80 cm <sup>4</sup>	19.60 cm <sup>4</sup>
Section Modulus (S)	4.75 cm <sup>3</sup>	9.50 cm <sup>3</sup>
Radius of Gyration (r)	1.65 cm	1.65 cm

Notes:

\* Load limited by spot weld shear.

\*\* KL/r > 200

NR = Not Recommended.

- Beam loads are given in total uniform load (WLbs) not uniform load (w lbs/ft or w lbs/in).
- Beam loads are based on a simple span and assumed to be adequately laterally braced. Unbraced spans can reduce beam load carrying capacity. Refer to Page 62 for reduction factors for unbraced lengths.
- For pierced channel, multiply beam loads by the following factor:  
 "KO" Series ..... 95%                      "T" Series ..... 85%  
 "HS" Series ..... 90%                      "SL" Series ..... 85%  
 "H3" Series ..... 90%                      "DS" Series ..... 70%  
 "WT" Series ..... 85%
- Deduct channel weight from the beam loads.
- For concentrated midspan point loads, multiply beam loads by 50% and the corresponding deflection by 80%. For other load conditions refer to page 18.
- All beam loads are for bending about Axis 1-1.

**P1000 Channel Combinations**

**P1001 T** DF GR PG

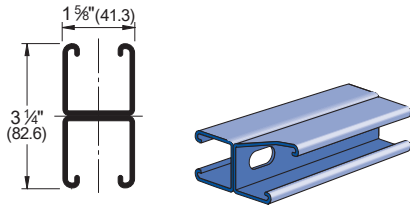

W/100 Ft: 321 Lbs (478 kg/100 m)  
Allowable Moment 12,200 In-Lbs (1,378 N•m)  
12 Gauge Nominal Thickness .105" (2.7mm)

**P1001 A**

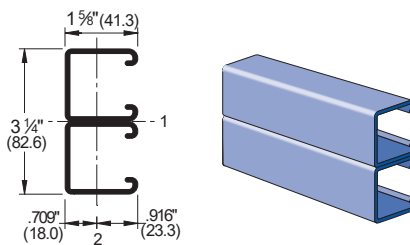

W/100 Ft: 378 Lbs (562 kg/100 m)  
Allowable Moment 18,640 In-Lbs (2,110 N•m)  
12 Gauge Nominal Thickness .105" (2.7mm)

**P1001 B** GR PG

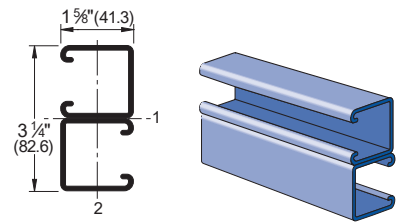

W/100 Ft: 378 Lbs (562 kg/100 m)  
Allowable Moment 18,640 In-Lbs (2,110 N•m)  
12 Gauge Nominal Thickness .105" (2.7mm)

**P1001 C** GR PG

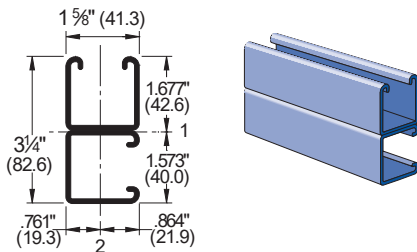

W/100 Ft: 378 Lbs (562 kg/100 m)  
Allowable Moment 15,950 In-Lbs (1,800 N•m)  
12 Gauge Nominal Thickness .105" (2.7mm)

**P1001 3**

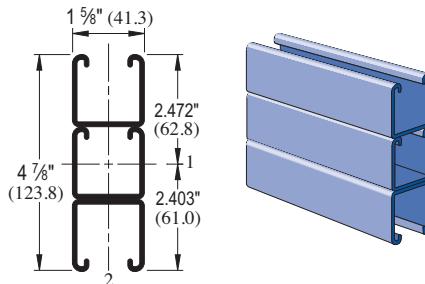

W/100 Ft: 566 Lbs (843 kg/100 m)  
Allowable Moment 31,840 In-Lbs (3,600 N•m)  
12 Gauge Nominal Thickness .105" (2.7mm)

**P1001 A3**

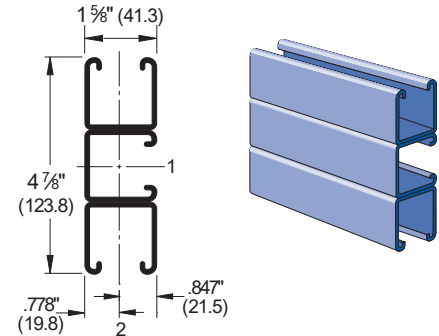

W/100 Ft: 566 Lbs (843 kg/100 m)  
Allowable Moment 32,770 In-Lbs (3,700 N•m)  
12 Gauge Nominal Thickness .105" (2.7mm)

**P1001 B3**

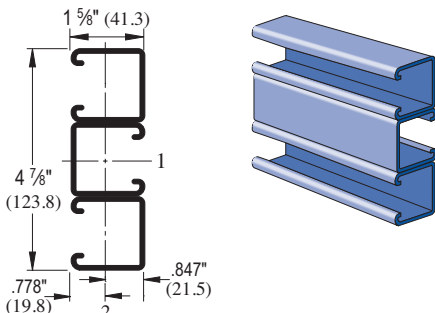

W/100 Ft: 566 Lbs (843 kg/100 m)  
Allowable Moment 37,550 In-Lbs (4,240 N•m)  
12 Gauge Nominal Thickness .105" (2.7mm)

**P1001 D3**

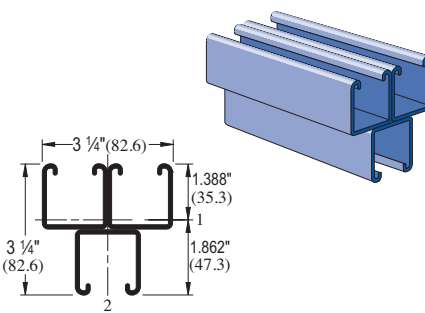

W/100 Ft: 566 Lbs (843 kg/100 m)  
Allowable Moment 17,550 In-Lbs (1,980 N•m)  
12 Gauge Nominal Thickness .105" (2.7mm)

**P1003**

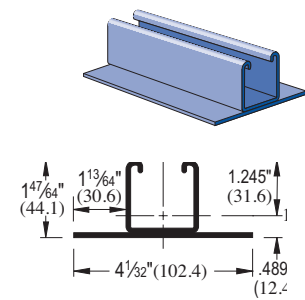

W/100 Ft: 333 Lbs (495 kg/100 m)  
Allowable Moment 6,240 In-Lbs (700 N•m)  
12 Gauge Nominal Thickness .105" (2.7mm)

**P1001 C41**

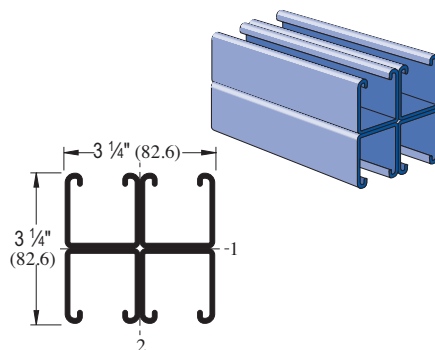

W/100 Ft: 755 Lbs (1,124 kg/100 m)  
Allowable Moment 28,720 In-Lbs (3,250 N•m)  
12 Gauge Nominal Thickness .105" (2.7mm)

**P1001 C3**

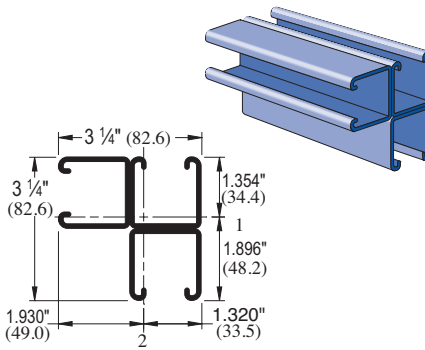

W/100 Ft: 566 Lbs (843 kg/100 m)  
Allowable Moment 18,680 In-Lbs (2,110 N•m)  
12 Gauge Nominal Thickness .105" (2.7mm)

**P1004 A**

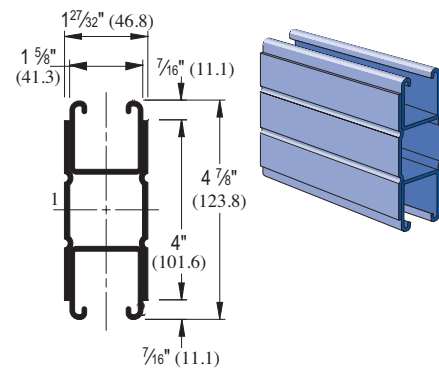

W/100 Ft: 668 Lbs (994 kg/100 m)  
Allowable Moment 41,970 In-Lbs (4,740 N•m)  
12 Gauge Nominal Thickness .105" (2.7mm)

Channel Finishes: DF, PL, GR, HG, PG, ZD; Standard Lengths: 10' & 20'

1 5/8" Channel  
Telestrut  
Nuts & Hardware  
General Fittings  
Pipe/Conduit Supports  
Electrical Fittings  
Concrete Inserts  
Solar  
Unipier®



1 1/8" Channel

Telestrut

Nuts & Hardware

General Fittings

Pipe/Conduit Supports

Electrical Fittings

Concrete Inserts

Solar

Unipier®

**P1001 C41 - BEAM LOADING**

Span In	Max Allowable Uniform Load Lbs	Defl. at Uniform Load In	Uniform Loading at Deflection		
			Span/180 Lbs	Span/240 Lbs	Span/360 Lbs
24	7,040*	0.02	7,040*	7,040*	7,040*
36	6,380	0.07	6,380	6,380	6,380
48	4,790	0.13	4,790	4,790	4,790
60	3,830	0.20	3,830	3,830	3,240
72	3,190	0.28	3,190	3,190	2,250
84	2,740	0.39	2,740	2,480	1,660
96	2,390	0.50	2,390	1,900	1,270
108	2,130	0.64	2,000	1,500	1,000
120	1,910	0.78	1,620	1,220	810
144	1,600	1.14	1,130	840	560
168	1,370	1.55	830	620	410
192	1,200	2.02	630	480	320
216	1,060	2.54	500	380	250
240	960	3.16	410	300	200

**P1004 A - BEAM LOADING**

Span In	Max Allowable Uniform Load Lbs	Defl. at Uniform Load In	Uniform Loading at Deflection		
			Span/180 Lbs	Span/240 Lbs	Span/360 Lbs
24	9,100*	0.01	9,100*	9,100*	9,100*
36	9,100*	0.05	9,100*	9,100*	9,100*
48	7,000	0.08	7,000	7,000	7,000
60	5,600	0.13	5,600	5,600	5,600
72	4,660	0.19	4,660	4,660	4,660
84	4,000	0.26	4,000	4,000	3,630
96	3,500	0.34	3,500	3,500	2,780
108	3,110	0.43	3,110	3,110	2,200
120	2,800	0.52	2,800	2,670	1,780
144	2,330	0.75	2,330	1,850	1,230
168	2,000	1.03	1,810	1,360	910
192	1,750	1.34	1,390	1,040	690
216	1,550	1.69	1,100	820	550
240	1,400	2.10	890	670	440

**P1001 C41 - COLUMN LOADING**

Unbraced Height In	Maximum Allowable Load at Slot Face Lbs	Maximum Column Load Applied at C.G.			
		K = 0.65 Lbs	K = 0.80 Lbs	K = 1.0 Lbs	K = 1.2 Lbs
24	12,690	46,920	44,980	42,360	39,890
36	12,250	42,680	39,890	36,660	34,050
48	11,820	38,740	35,720	32,640	30,430
60	11,470	35,500	32,640	29,980	28,220
72	11,180	32,970	30,430	28,220	26,820
84	10,900	31,040	28,840	27,010	24,870
96	10,580	29,570	27,680	26,170	19,840
108	10,310	28,440	26,820	22,310	15,670
120	10,070	27,560	26,170	18,280	12,700
144	8,740	26,320	19,840	12,700	8,820
168	7,360	21,890	14,570	9,330	**

**P1004 A - COLUMN LOADING**

Unbraced Height In	Maximum Allowable Load at Slot Face Lbs	Maximum Column Load Applied at C.G.			
		K = 0.65 Lbs	K = 0.80 Lbs	K = 1.0 Lbs	K = 1.2 Lbs
24	11,420	36,800	33,890	30,440	27,600
36	10,600	30,840	27,600	24,400	22,160
48	9,860	26,400	23,560	21,060	19,470
60	9,160	23,370	21,060	19,160	18,020
72	8,610	21,310	19,470	18,020	17,140
84	8,170	19,890	18,410	17,260	15,240
96	7,790	18,890	17,670	16,760	11,670
108	7,460	18,160	17,140	13,280	9,220
120	7,150	17,590	16,760	10,750	7,470
144	5,660	16,840	11,670	7,470	**
168	4,520	12,990	8,570	**	**

**P1001 C41/ P1004 A - ELEMENTS OF SECTION**

Parameter	P1001 C41	P1004 A
Area of Section	2.221 In <sup>2</sup>	1.965 In <sup>2</sup>
Axis 1-1		
Moment of Inertia (I)	1.856 In <sup>4</sup>	4.068 In <sup>4</sup>
Section Modulus (S)	1.142 In <sup>3</sup>	1.669 In <sup>3</sup>
Radius of Gyration (r)	0.914 In	1.439 In
Axis 2-2		
Moment of Inertia (I)	2.408 In <sup>4</sup>	1.092 In <sup>4</sup>
Section Modulus (S)	1.482 In <sup>3</sup>	1.190 In <sup>3</sup>
Radius of Gyration (r)	1.041 In	0.745 In

Notes:

\* Load limited by spot weld shear.

\*\* KL/r > 200

NR = Not Recommended.

- Beam loads are given in total uniform load (WLbs) not uniform load (w lbs/ft or w lbs/in).
- Beam loads are based on a simple span and assumed to be adequately laterally braced. Unbraced spans can reduce beam load carrying capacity. Refer to Page 62 for reduction factors for unbraced lengths.
- For pierced channel, multiply beam loads by the following factor:  
 "KO" Series ..... 95%                      "T" Series ..... 85%  
 "HS" Series ..... 90%                      "SL" Series ..... 85%  
 "WT" Series ..... 85%
- Deduct channel weight from the beam loads.
- For concentrated midspan point loads, multiply beam loads by 50% and the corresponding deflection by 80%. For other load conditions refer to page 18.
- All beam loads are for bending about Axis 1-1.

# P1000 Channel Combinations

## P1001 C41 - BEAM LOADING (METRIC)

Span mm	Max Allowable Uniform Load kN	Defl. at Uniform Load mm	Uniform Loading at Deflection		
			Span/180 kN	Span/240 kN	Span/360 kN
600	31.3*	1	31.3*	31.3*	31.3*
750	31.3*	1	31.3*	31.3*	31.3*
1,000	26.0	2	26.0	26.0	26.0
1,250	20.8	3	20.8	20.8	20.8
1,500	17.3	5	17.3	17.3	14.9
1,750	14.8	7	14.8	14.8	10.9
2,000	13.0	9	13.0	12.6	8.4
2,500	10.4	13	10.4	8.1	5.4
3,000	8.7	19	7.4	5.6	3.7
3,500	7.4	26	5.5	4.1	2.8
4,000	6.5	34	4.2	3.2	2.1
4,500	5.8	44	3.3	2.5	1.6
5,000	5.2	54	2.7	2.0	1.3
6,000	4.3	77	1.9	1.4	0.9

## P1004 A - BEAM LOADING (METRIC)

Span mm	Max Allowable Uniform Load kN	Defl. at Uniform Load mm	Uniform Loading at Deflection		
			Span/180 kN	Span/240 kgN	Span/360 kN
600	40.5*	1	40.5*	40.5*	40.5*
750	40.5*	1	40.5*	40.5*	40.5*
1,000	37.9	2	37.9	37.9	37.9
1,250	30.3	3	30.3	30.3	30.3
1,500	25.3	4	25.3	25.3	25.3
1,750	21.7	6	21.7	21.7	21.7
2,000	18.9	9	18.9	18.9	18.4
2,500	15.2	13	15.2	15.2	11.7
3,000	12.6	18	12.6	12.2	8.2
3,500	10.9	23	10.9	9.0	6.0
4,000	9.5	29	9.2	6.9	4.6
4,500	8.5	36	7.2	5.4	3.6
5,000	7.6	52	5.9	4.4	2.9
6,000	6.3	77	4.1	3.1	2.0

## P1001 C41 - COLUMN LOADING (METRIC)

Unbraced Height mm	Maximum Allowable Load at Slot Face kN	Maximum Column Load Applied at C.G.			
		K = 0.65 kN	K = 0.80 kN	K = 1.0 kN	K = 1.2 kN
600	56.5	209.3	200.8	189.3	178.4
750	55.6	200.1	189.3	175.8	164.1
1,000	53.9	184.7	171.7	157.3	146.1
1,250	52.4	170.7	157.3	143.8	134.1
1,500	51.1	158.9	146.1	134.1	126.1
1,750	50.0	149.3	137.6	127.3	120.7
2,000	49.2	141.5	131.1	122.3	116.8
2,250	47.9	135.4	126.1	118.6	101.9
2,500	46.8	130.4	122.3	114.5	83.9
2,750	45.9	126.4	119.2	98.8	69.4

## P1004 A - COLUMN LOADING (METRIC)

Unbraced Height mm	Maximum Allowable Load at Slot Face kN	Maximum Column Load Applied at C.G.			
		K = 0.65 kN	K = 0.80 kN	K = 1.0 kN	K = 1.2 kN
600	50.9	164.6	151.8	136.5	123.8
750	49.1	150.8	136.5	121.1	109.5
1,000	46.3	130.9	116.9	103.4	94.3
1,250	43.5	115.8	103.4	92.6	85.8
1,500	40.9	104.8	94.3	85.8	80.6
1,750	38.9	96.8	88.1	81.3	77.0
2,000	37.1	91.0	83.7	78.1	74.8
2,250	35.7	86.6	80.6	75.8	60.9
2,500	34.3	83.3	78.1	71.1	49.4
2,750	33.1	80.7	76.2	58.8	40.8

## P1001 C41/ P1004 A - ELEMENTS OF SECTION (METRIC)

Parameter	P1001 C41	P1004 A
Area of Section	14.33 cm <sup>2</sup>	12.68 cm <sup>2</sup>
Axis 1-1		
Moment of Inertia (I)	77.24 cm <sup>4</sup>	169.33 cm <sup>4</sup>
Section Modulus (S)	18.71 cm <sup>3</sup>	27.35 cm <sup>3</sup>
Radius of Gyration (r)	2.32 cm	3.66 cm
Axis 2-2		
Moment of Inertia (I)	100.24 cm <sup>4</sup>	45.44 cm <sup>4</sup>
Section Modulus (S)	24.29 cm <sup>3</sup>	19.50 cm <sup>3</sup>
Radius of Gyration (r)	2.64 cm	1.89 cm

### Notes:

\* Load limited by spot weld shear.

\*\* KL/r > 200

NR = Not Recommended.

- Beam loads are given in total uniform load (W Lbs) not uniform load (w lbs/ft or w lbs/in).
- Beam loads are based on a simple span and assumed to be adequately laterally braced. Unbraced spans can reduce beam load carrying capacity. Refer to Page 62 for reduction factors for unbraced lengths.
- For pierced channel, multiply beam loads by the following factor:  
"KO" Series .....95%                      "T" Series .....85%  
"HS" Series .....90%                      "SL" Series .....85%  
"WT" Series .....85%
- Deduct channel weight from the beam loads.
- For concentrated midspan point loads, multiply beam loads by 50% and the corresponding deflection by 80%. For other load conditions refer to page 18.
- All beam loads are for bending about Axis 1-1.

1 1/8" Channel  
Telestrut  
Nuts & Hardware  
General Fittings  
Pipe/Conduit Supports  
Electrical Fittings  
Concrete Inserts  
Solar  
Unipier®



1 5/8" Channel

Telestrut

General Fittings Nuts & Hardware

Pipe/Conduit Supports

Electrical Fittings

Concrete Inserts

Solar

Unipier®

**P1100**

**GR PG**

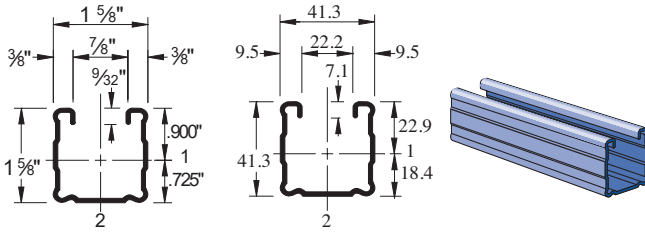

Ww/100 Ft: 142 Lbs (211 kg/100 m)  
Allowable Moment 4,060 In-Lbs (460 N·m)  
14 Gauge Nominal Thickness .075" (1.9mm)

**P1101**

**GR PG**

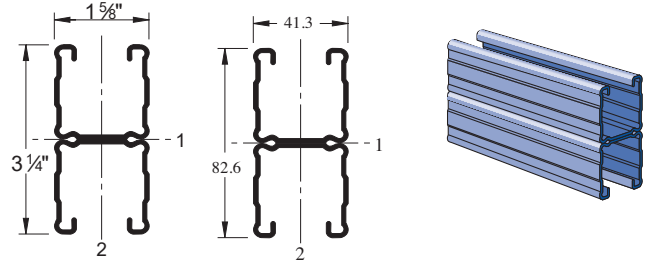

Ww/100 Ft: 284 Lbs (423 kg/100 m)  
Allowable Moment 11,340 In-Lbs (1,280 N·m)  
14 Gauge Nominal Thickness .075" (1.9mm)

**P1101 A**

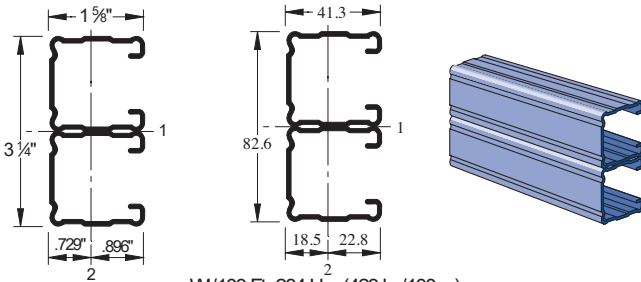

Ww/100 Ft: 284 Lbs (423 kg/100 m)  
Allowable Moment 14,000 In-Lbs (1,580 N·m)  
14 Gauge Nominal Thickness .075" (1.9mm)

**P1101 B**

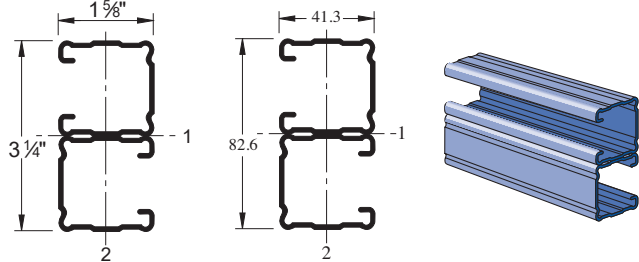

Ww/100 Ft: 284 Lbs (423 kg/100 m)  
Allowable Moment 14,000 In-Lbs (1,580 N·m)  
14 Gauge Nominal Thickness .075" (1.9mm)

**P1101 C**

**GR PG**

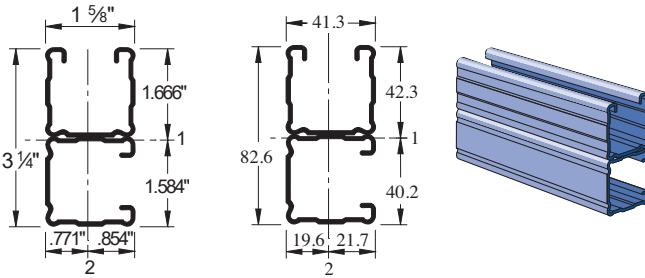

Ww/100 Ft: 284 Lbs (423 kg/100 m)  
Allowable Moment 12,330 In-Lbs (1,390 N·m)  
14 Gauge Nominal Thickness .075" (1.9mm)

**P1100 HS**

**GR PG**

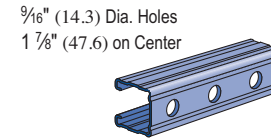

Ww/100 Ft: 136 Lbs (202 kg/100 m)

**P1100 KO**

**GR PG**

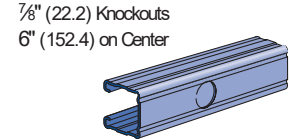

Ww/100 Ft: 140 Lbs (208 kg/100 m)

**P1100 SL**

**GR PG**

Slots are  
3" (76.2) x 1 1/2" (10.3)  
4" (101.6) on Center

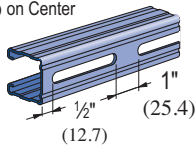

Ww/100 Ft: 136 Lbs (202 kg/100 m)

**P1100 T**

**GR PG**

Slots are  
1 1/8" (28.6) x 9/16" (14.3)  
2" (50.8) on Center

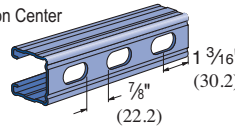

Ww/100 Ft: 136 Lbs (202 kg/100 m)

**P1100 WT**

**DF GR HG PG PL**

Slots are  
2" (50.8) x 1 1/16" (17.5)  
3" (76.2) on Center

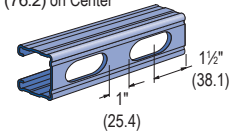

Ww/100 Ft: 136 Lbs (202 kg/100 m)

**CHANNEL NUTS (REFER TO PAGES 73,74 FOR DETAILS)**

**SEE PAGE 73, 74**

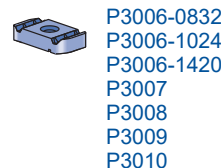
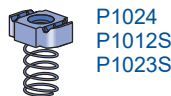
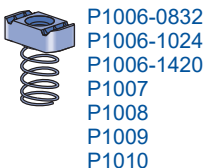

Channel Finishes: DF, PL, GR, HG, PG, ZD; Standard Lengths: 10' & 20'

## P1100 & P1101 Channels

### P1100 - BEAM LOADING

Span In	Max Allowable Uniform Load Lbs	Defl. at Uniform Load In	Uniform Loading at Deflection		
			Span/180 Lbs	Span/240 Lbs	Span/360 Lbs
24	1,350	0.06	1,350	1,350	1,350
36	900	0.13	900	900	700
48	680	0.23	680	590	400
60	540	0.36	510	380	250
72	450	0.51	350	260	180
84	390	0.70	260	190	130
96	340	0.92	200	150	100
108	300	1.15	160	120	80
120	270	1.42	130	90	60
144	230	2.09	90	70	40
168	190	2.75	60	50	30
192	170	3.67	50	40	NR
216	150	4.61	40	30	NR
240	140	5.90	30	NR	NR

### P1101 - BEAM LOADING

Span In	Max Allowable Uniform Load Lbs	Defl. at Uniform Load In	Uniform Loading at Deflection		
			Span/180 Lbs	Span/240 Lbs	Span/360 Lbs
24	2,180*	0.02	2,180*	2,180*	2,180*
36	2,180*	0.06	2,180*	2,180*	2,180*
48	1,890	0.13	1,890	1,890	1,890
60	1,510	0.20	1,510	1,510	1,280
72	1,260	0.28	1,260	1,260	890
84	1,080	0.39	1,080	980	650
96	950	0.51	950	750	500
108	840	0.64	790	590	400
120	760	0.79	640	480	320
144	630	1.13	440	330	220
168	540	1.54	330	250	160
192	470	2.00	250	190	130
216	420	2.55	200	150	100
240	380	3.16	160	120	80

### P1100 - COLUMN LOADING

Unbraced Height In	Maximum Allowable Load at Slot Face Lbs	Maximum Column Load Applied at C.G.			
		K = 0.65 Lbs	K = 0.80 Lbs	K = 1.0 Lbs	K = 1.2 Lbs
24	2,800	8,040	7,330	6,360	5,430
36	2,410	6,480	5,430	4,190	3,210
48	1,940	4,990	3,830	2,760	2,160
60	1,550	3,740	2,760	2,050	1,640
72	1,290	2,860	2,160	1,640	1,320
84	1,100	2,310	1,780	1,370	1,110
96	950	1,950	1,520	1,180	950
108	840	1,690	1,320	1,030	**
120	760	1,490	1,180	**	**
144	630	1,210	950	**	**

### P1101 - COLUMN LOADING

Unbraced Height In	Maximum Allowable Load at Slot Face Lbs	Maximum Column Load Applied at C.G.			
		K = 0.65 Lbs	K = 0.80 Lbs	K = 1.0 Lbs	K = 1.2 Lbs
24	5,010	18,250	17,700	16,880	16,030
36	4,860	16,990	16,030	14,770	13,620
48	4,700	15,610	14,380	12,930	11,750
60	4,480	14,280	12,930	11,490	9,290
72	4,210	13,100	11,750	9,290	6,700
84	3,880	12,090	10,220	7,090	4,930
96	3,480	11,170	8,390	5,430	3,770
108	3,060	9,640	6,700	4,290	2,980
120	2,680	8,170	5,430	3,480	**
144	2,090	5,710	3,770	**	**

### P1100/P1101 - ELEMENTS OF SECTION

Parameter	P1100		P1101	
Area of Section	0.418	In <sup>2</sup>	0.835	In <sup>2</sup>
Axis 1-1				
Moment of Inertia (I)	0.145	In <sup>4</sup>	0.733	In <sup>4</sup>
Section Modulus (S)	0.162	In <sup>3</sup>	0.451	In <sup>3</sup>
Radius of Gyration (r)	0.589	In	0.937	In
Axis 2-2				
Moment of Inertia (I)	0.176	In <sup>4</sup>	0.353	In <sup>4</sup>
Section Modulus (S)	0.217	In <sup>3</sup>	0.434	In <sup>3</sup>
Radius of Gyration (r)	0.650	In	0.650	In

#### Notes:

\* Load limited by spot weld shear.

\*\* KL/r > 200

NR = Not Recommended.

- Beam loads are given in total uniform load (W Lbs) not uniform load (w lbs/ft or w lbs/in).
- Beam loads are based on a simple span and assumed to be adequately laterally braced. Unbraced spans can reduce beam load carrying capacity. Refer to Page 62 for reduction factors for unbraced lengths.
- For pierced channel, multiply beam loads by the following factor:  
 "KO" Series ..... 95%                      "T" Series ..... 85%  
 "HS" Series ..... 90%                      "SL" Series ..... 85%  
 "WT" Series ..... 85%
- Deduct channel weight from the beam loads.
- For concentrated midspan point loads, multiply beam loads by 50% and the corresponding deflection by 80%. For other load conditions refer to page 18.
- All beam loads are for bending about Axis 1-1.

1 1/8" Channel

Telestrut

Nuts & Hardware

General Fittings

Pipe/Conduit Supports

Electrical Fittings

Concrete Inserts

Solar

Unipier®



**P1100 - BEAM LOADING (METRIC)**

Span mm	Max Allowable Uniform Load kN	Defl. at Uniform Load mm	Uniform Loading at Deflection		
			Span/180 kN	Span/240 kN	Span/360 kN
600	6.1	1	6.1	6.1	6.1
750	4.9	2	4.9	4.9	4.7
1,000	3.7	4	3.7	3.7	2.6
1,250	2.9	6	2.9	2.5	1.7
1,500	2.4	9	2.3	1.7	1.2
1,750	2.1	12	1.7	1.3	0.8
2,000	1.8	15	1.3	1.0	0.7
2,500	1.5	24	0.8	0.6	0.4
3,000	1.2	36	0.6	0.4	0.3
3,500	1.1	49	0.4	0.3	0.2
4,000	0.9	64	0.3	0.3	0.2
4,500	0.8	77	0.3	0.2	0.1
5,000	0.8	100	0.2	0.2	NR
6,000	0.6	143	0.1	NR	NR

**P1101 - BEAM LOADING (METRIC)**

Span mm	Max Allowable Uniform Load kN	Defl. at Uniform Load mm	Uniform Loading at Deflection		
			Span/180 kN	Span/240 kN	Span/360 kN
600	9.7*	0	9.7*	9.7*	9.7*
750	9.7*	1	9.7*	9.7*	9.7*
1,000	9.7*	2	9.7*	9.7*	9.7*
1,250	8.2	3	8.2	8.2	8.2
1,500	6.9	5	6.9	6.9	5.9
1,750	5.9	7	5.9	5.9	4.3
2,000	5.1	9	5.1	5.0	3.3
2,500	4.1	13	4.1	3.2	2.1
3,000	3.4	19	2.9	2.2	1.5
3,500	2.9	26	2.2	1.6	1.1
4,000	2.6	35	1.6	1.2	0.8
4,500	2.3	43	1.3	1.0	0.7
5,000	2.0	54	1.1	0.8	0.5
6,000	1.7	77	0.8	0.5	0.4

**P1100 - COLUMN LOADING (METRIC)**

Unbraced Height mm	Maximum Allowable Load at Slot Face kN	Maximum Column Load Applied at C.G.			
		K = 0.65 kN	K = 0.80 kN	K = 1.0 kN	K = 1.2 kN
600	12.5	35.9	32.9	28.6	24.5
750	11.8	32.6	28.6	23.5	19.0
1,000	10.1	26.9	22.0	16.4	12.5
1,250	8.5	21.6	16.4	11.8	9.3
1,500	7.0	17.0	12.5	9.3	7.4
1,750	6.0	13.5	10.1	7.7	6.2
2,000	5.2	11.2	8.6	6.5	5.3
2,250	4.6	9.6	7.4	5.7	4.7
2,500	4.1	8.4	6.5	5.1	**
2,750	3.7	7.5	5.9	4.5	**

**P1101 - COLUMN LOADING (METRIC)**

Unbraced Height mm	Maximum Allowable Load at Slot Face kN	Maximum Column Load Applied at C.G.			
		K = 0.65 kN	K = 0.80 kN	K = 1.0 kN	K = 1.2 kN
600	22.3	81.4	79.0	75.4	71.7
750	22.0	78.7	75.4	70.7	66.1
1,000	21.4	73.8	69.2	63.3	58.0
1,250	20.8	68.8	63.3	56.8	51.6
1,500	20.0	64.0	58.0	51.6	42.3
1,750	19.0	59.5	53.5	44.0	32.6
2,000	18.0	55.6	49.2	35.7	25.0
2,250	16.6	52.3	42.3	28.4	19.7
2,500	15.1	48.3	35.7	23.0	16.0
2,750	13.6	42.7	29.7	19.0	13.2

**P1100/P1101 - ELEMENTS OF SECTION (METRIC)**

Parameter	P1100		P1101	
Area of Section	2.69	cm <sup>2</sup>	5.39	cm <sup>2</sup>
Axis 1-1				
Moment of Inertia (I)	6.03	cm <sup>4</sup>	30.51	cm <sup>4</sup>
Section Modulus (S)	2.65	cm <sup>3</sup>	7.39	cm <sup>3</sup>
Radius of Gyration (r)	1.50	cm	2.38	cm
Axis 2-2				
Moment of Inertia (I)	7.34	cm <sup>4</sup>	14.69	cm <sup>4</sup>
Section Modulus (S)	3.56	cm <sup>3</sup>	7.12	cm <sup>3</sup>
Radius of Gyration (r)	1.65	cm	1.65	cm

Notes:

\* Load limited by spot weld shear.

\*\* KL/r > 200

NR = Not Recommended.

- Beam loads are given in total uniform load (WLbs) not uniform load (w lbs/ft or w lbs/in).
- Beam loads are based on a simple span and assumed to be adequately laterally braced. Unbraced spans can reduce beam load carrying capacity. Refer to Page 62 for reduction factors for unbraced lengths.
- For pierced channel, multiply beam loads by the following factor:  
 "KO" Series ..... 95%                      "T" Series ..... 85%  
 "HS" Series ..... 90%                      "SL" Series ..... 85%  
 "WT" Series ..... 85%
- Deduct channel weight from the beam loads.
- For concentrated midspan point loads, multiply beam loads by 50% and the corresponding deflection by 80%. For other load conditions refer to page 18.
- All beam loads are for bending about Axis 1-1.



**P2000 & P2001 Channels**

**P2000**

**GR PG**

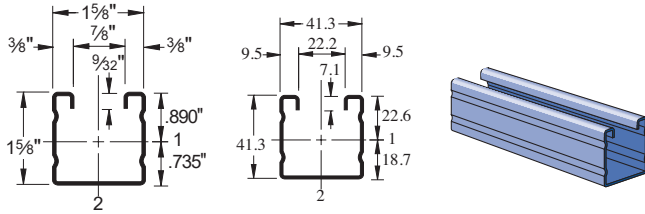

W/100 Ft: 116 Lbs (173 kg/100 m)  
Allowable Moment 3,520 In-Lbs (400 N•m)  
16 Gauge Nominal Thickness .060" (1.5mm)

**P2001**

**GR PG**

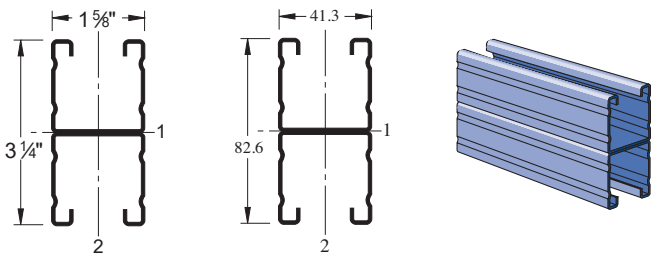

W/100 Ft: 232 Lbs (346 kg/100 m)  
Allowable Moment 9,570 In-Lbs (1,080 N•m)  
16 Gauge Nominal Thickness .060" (1.5mm)

**P2001 A**

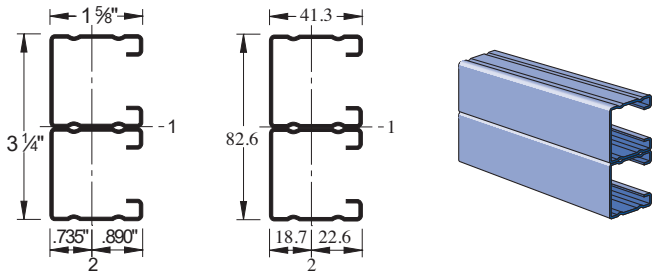

W/100 Ft: 232 Lbs (346 kg/100 m)  
Allowable Moment 11,660 In-Lbs (1,320 N•m)  
16 Gauge Nominal Thickness .060" (1.5mm)

**P2001 B**

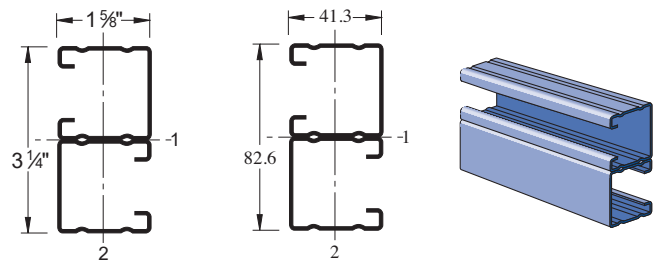

W/100 Ft: 232 Lbs (346 kg/100 m)  
Allowable Moment 11,660 In-Lbs (1,320 N•m)  
16 Gauge Nominal Thickness .060" (1.5mm)

**P2001 C**

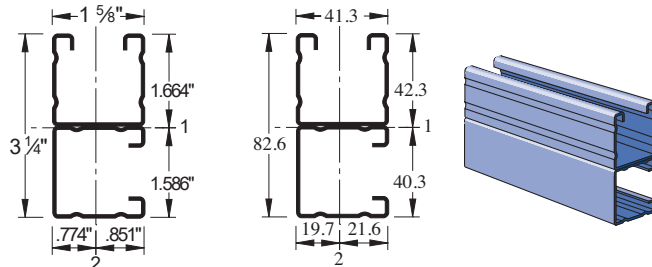

W/100 Ft: 232 Lbs (346 kg/100 m)  
Allowable Moment 10,350 In-Lbs (1,170 N•m)  
16 Gauge Nominal Thickness .060" (1.5mm)

**P2000 HS**

**GR PG**

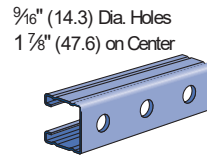

W/100 Ft: 113 Lbs (168 kg/100 m)

**P2000 KO**

**GR PG**

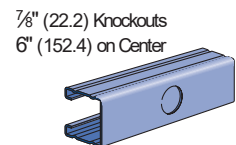

W/100 Ft: 117 Lbs (174 kg/100 m)

**P2000 SL**

**GR PG**

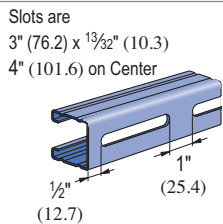

W/100 Ft: 113 Lbs (168 kg/100 m)

**P2000 T**

**GR PG**

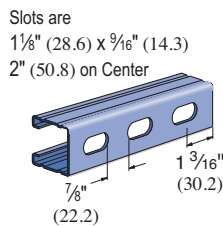

W/100 Ft: 113 Lbs (168 kg/100 m)

**P2000 WT**

**DF GR HG PG PL**

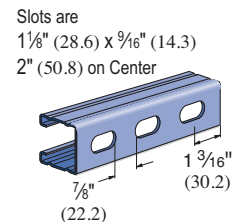

W/100 Ft: 113 Lbs (168 kg/100 m)

**CHANNEL NUTS (REFER TO PAGES 73,74 FOR DETAILS)**

**SEE PAGE 73, 74**

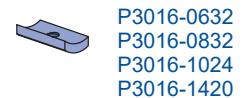
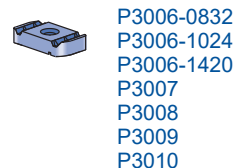
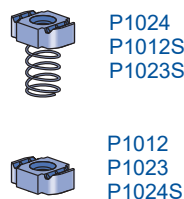
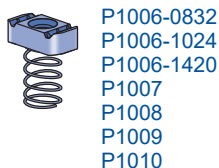

Channel Finishes: PL, GR, HG, PG, ZD; Standard Lengths: 10' & 20'



1 1/8" Channel

Telestrut

Nuts & Hardware

General Fittings

Pipe/Conduit Supports

Electrical Fittings

Concrete Inserts

Solar

Unipier®

**P2000 - BEAM LOADING**

Span In	Max Allowable Uniform Load Lbs	Defl. at Uniform Load In	Uniform Loading at Deflection		
			Span/180 Lbs	Span/240 Lbs	Span/360 Lbs
24	1,170	0.06	1,170	1,170	1,170
36	780	0.13	780	780	610
48	590	0.23	590	510	340
60	470	0.36	440	330	220
72	390	0.52	300	230	150
84	340	0.71	220	170	110
96	290	0.91	170	130	90
108	260	1.16	130	100	70
120	230	1.41	110	80	50
144	200	2.12	80	60	40
168	170	2.86	60	40	30
192	150	3.76	40	30	20
216	130	4.64	30	30	NR
240	120	5.88	30	NR	NR

**P2001 - BEAM LOADING**

Span In	Max Allowable Uniform Load Lbs	Defl. at Uniform Load In	Uniform Loading at Deflection		
			Span/180 Lbs	Span/240 Lbs	Span/360 Lbs
24	1,610*	0.02	1,610*	1,610*	1,610*
36	1,610*	0.05	1,610*	1,610*	1,610*
48	1,600	0.13	1,600	1,600	1,600
60	1,280	0.20	1,280	1,280	1,080
72	1,060	0.28	1,060	1,060	750
84	910	0.38	910	830	550
96	800	0.51	800	630	420
108	710	0.64	670	500	330
120	640	0.79	540	410	270
144	530	1.13	380	280	190
168	460	1.56	280	210	140
192	400	2.02	210	160	110
216	350	2.52	170	130	80
240	320	3.16	140	100	70

**P2000 - COLUMN LOADING**

Unbraced Height In	Maximum Allowable Load at Slot Face Lbs	Maximum Column Load Applied at C.G.			
		K = 0.65 Lbs	K = 0.80 Lbs	K = 1.0 Lbs	K = 1.2 Lbs
24	2,400	6,650	6,080	5,280	4,470
36	2,050	5,380	4,470	3,370	2,500
48	1,600	4,090	3,040	2,100	1,590
60	1,230	2,960	2,100	1,500	1,160
72	970	2,190	1,590	1,160	910
84	790	1,720	1,270	950	760
96	660	1,410	1,060	800	650
108	570	1,200	910	700	**
120	510	1,040	800	620	**
144	420	830	650	**	**

**P2001 - COLUMN LOADING**

Unbraced Height In	Maximum Allowable Load at Slot Face Lbs	Maximum Column Load Applied at C.G.			
		K = 0.65 Lbs	K = 0.80 Lbs	K = 1.0 Lbs	K = 1.2 Lbs
24	4,200	15,030	14,600	13,940	13,220
36	4,070	14,030	13,220	12,090	10,990
48	3,920	12,850	11,720	10,290	9,040
60	3,700	11,630	10,290	8,760	7,530
72	3,410	10,460	9,040	7,530	5,740
84	3,140	9,410	7,990	6,080	4,220
96	2,890	8,490	7,120	4,650	3,230
108	2,530	7,700	5,740	3,680	2,550
120	2,210	6,950	4,650	2,980	**
144	1,690	4,890	3,230	**	**

**P2000/P2001 - ELEMENTS OF SECTION**

Parameter	P2000		P2001	
Area of Section	0.342	In <sup>2</sup>	0.684	In <sup>2</sup>
Axis 1-1				
Moment of Inertia (I)	0.125	In <sup>4</sup>	0.618	In <sup>4</sup>
Section Modulus (S)	0.140	In <sup>3</sup>	0.381	In <sup>3</sup>
Radius of Gyration (r)	0.604	In	0.951	In
Axis 2-2				
Moment of Inertia (I)	0.151	In <sup>4</sup>	0.302	In <sup>4</sup>
Section Modulus (S)	0.186	In <sup>3</sup>	0.372	In <sup>3</sup>
Radius of Gyration (r)	0.665	In	0.665	In

Notes:

\* Load limited by spot weld shear.

\*\* KL/r > 200

NR = Not Recommended.

- Beam loads are given in total uniform load (WLbs) not uniform load (w lbs/ft or w lbs/in).
- Beam loads are based on a simple span and assumed to be adequately laterally braced. Unbraced spans can reduce beam load carrying capacity. Refer to Page 62 for reduction factors for unbraced lengths.
- For pierced channel, multiply beam loads by the following factor:  
 "KO" Series ..... 95%                      "T" Series ..... 85%  
 "HS" Series ..... 90%                      "SL" Series ..... 85%  
 "WT" Series ..... 85%
- Deduct channel weight from the beam loads.
- For concentrated midspan point loads, multiply beam loads by 50% and the corresponding deflection by 80%. For other load conditions refer to page 18.
- All beam loads are for bending about Axis 1-1.

**P2000 & P2001 Channels**

**P2000 - BEAM LOADING (METRIC)**

Span mm	Max Allowable Uniform Load kN	Defl. at Uniform Load mm	Uniform Loading at Deflection		
			Span/180 kN	Span/240 kN	Span/360 kN
600	5.3	1	5.3	5.3	5.3
750	4.2	2	4.2	4.2	4.0
1,000	3.2	4	3.2	3.2	2.3
1,250	2.5	6	2.5	2.2	1.4
1,500	2.1	9	2.0	1.5	1.0
1,750	1.8	12	1.5	1.1	0.8
2,000	1.6	16	1.1	0.8	0.6
2,500	1.3	25	0.7	0.5	0.4
3,000	1.1	36	0.5	0.4	0.3
3,500	0.9	47	0.4	0.3	0.2
4,000	0.8	63	0.3	0.2	0.1
4,500	0.7	80	0.2	0.2	0.1
5,000	0.6	96	0.2	0.1	0.1
6,000	0.5	142	0.1	NR	NR

**P2001 - BEAM LOADING (METRIC)**

Span mm	Max Allowable Uniform Load kN	Defl. at Uniform Load mm	Uniform Loading at Deflection		
			Span/180 kN	Span/240 kN	Span/360 kN
600	7.2*	0	7.2*	7.2*	7.2*
750	7.2*	1	7.2*	7.2*	7.2*
1,000	7.2*	2	7.2*	7.2*	7.2*
1,250	6.9	3	6.9	6.9	6.9
1,500	5.8	5	5.8	5.8	5.0
1,750	4.9	7	4.9	4.9	3.6
2,000	4.3	9	4.3	4.2	2.8
2,500	3.5	13	3.5	2.7	1.8
3,000	2.9	19	2.5	1.9	1.2
3,500	2.5	27	1.8	1.4	0.9
4,000	2.2	35	1.4	1.1	0.7
4,500	1.9	43	1.1	0.8	0.5
5,000	1.7	54	0.9	0.7	0.4
6,000	1.4	76	0.6	0.4	0.3

**P2000 - COLUMN LOADING (METRIC)**

Unbraced Height mm	Maximum Allowable Load at Slot Face kN	Maximum Column Load Applied at C.G.			
		K = 0.65 kN	K = 0.80 kN	K = 1.0 kN	K = 1.2 kN
600	10.7	29.8	27.3	23.8	20.2
750	10.1	27.0	23.8	19.3	15.3
1,000	8.5	22.3	18.0	12.9	9.6
1,250	6.9	17.6	12.9	9.0	6.8
1,500	5.6	13.5	9.6	6.8	5.2
1,750	4.6	10.5	7.6	5.5	4.3
2,000	3.8	8.5	6.2	4.6	3.6
2,250	3.3	7.1	5.2	4.0	3.2
2,500	2.8	6.1	4.6	3.5	2.8
2,750	2.5	5.3	4.1	3.1	**

**P2001 - COLUMN LOADING (METRIC)**

Unbraced Height mm	Maximum Allowable Load at Slot Face kN	Maximum Column Load Applied at C.G.			
		K = 0.65 kN	K = 0.80 kN	K = 1.0 kN	K = 1.2 kN
600	18.7	67.0	65.1	62.2	59.1
750	18.4	64.9	62.2	58.3	54.2
1,000	17.9	61.0	56.9	51.5	46.3
1,250	17.3	56.6	51.5	45.0	39.5
1,500	16.5	52.1	46.3	39.5	34.0
1,750	15.5	47.9	41.6	34.8	27.9
2,000	14.5	43.9	37.5	30.4	21.3
2,250	13.6	40.2	34.0	24.3	16.9
2,500	12.5	37.0	30.4	19.7	13.7
2,750	11.3	34.2	25.4	16.3	11.3

**P2000/P2001 - ELEMENTS OF SECTION (METRIC)**

Parameter	P2000		P2001	
Area of Section	2.21	cm <sup>2</sup>	4.41	cm <sup>2</sup>
Axis 1-1				
Moment of Inertia (I)	5.19	cm <sup>4</sup>	25.74	cm <sup>4</sup>
Section Modulus (S)	2.29	cm <sup>3</sup>	6.24	cm <sup>3</sup>
Radius of Gyration (r)	1.53	cm	2.42	cm
Axis 2-2				
Moment of Inertia (I)	6.29	cm <sup>4</sup>	12.58	cm <sup>4</sup>
Section Modulus (S)	3.05	cm <sup>3</sup>	6.10	cm <sup>3</sup>
Radius of Gyration (r)	1.69	cm	1.69	cm

Notes:

\* Load limited by spot weld shear.

\*\* KL/r > 200

NR = Not Recommended.

- Beam loads are given in total uniform load (W Lbs) not uniform load (w lbs/ft or w lbs/in).
- Beam loads are based on a simple span and assumed to be adequately laterally braced. Unbraced spans can reduce beam load carrying capacity. Refer to page 62 for reduction factors for unbraced lengths.
- For pierced channel, multiply beam loads by the following factor:  
"KO" Series .....95%                      "T" Series .....85%  
"HS" Series .....90%                      "SL" Series .....85%  
"WT" Series .....85%
- Deduct channel weight from the beam loads.
- For concentrated midspan point loads, multiply beam loads by 50% and the corresponding deflection by 80%. For other load conditions refer to page 18.
- All beam loads are for bending about Axis 1-1.

1 1/8" Channel

Telestrut

Nuts & Hardware

General Fittings

Pipe/Conduit Supports

Electrical Fittings

Concrete Inserts

Solar

Unipier®



1 5/8" Channel

Telestrut

Nuts & Hardware

General Fittings

Pipe/Conduit Supports

Electrical Fittings

Concrete Inserts

Solar

Unipier®

**P3000**

**GR PG**

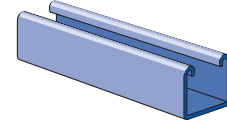
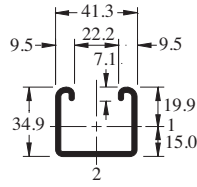
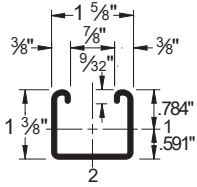

W/100 Ft: 170 Lbs (253 kg/100 m)  
Allowable Moment 3,840 In-Lbs (430 N·m)  
12 Gauge Nominal Thickness .105" (2.7mm)

**P3001**

**GR PG**

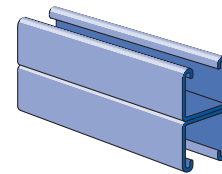
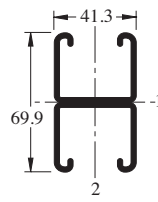
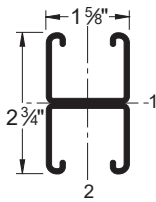

W/100 Ft: 340 Lbs (506 kg/100 m)  
Allowable Moment 10,810 In-Lbs (1,220 N·m)  
12 Gauge Nominal Thickness .105" (2.7mm)

**P3000 HS**

**GR PG**

9/16" (14.3) Dia. Holes  
1 7/8" (47.6) on Center

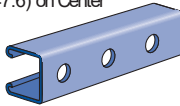

W/100 Ft: 165 Lbs (246 kg/100 m)

**P3000 KO**

**GR PG**

7/8" (22.2) Knockouts  
6" (152.4) on Center

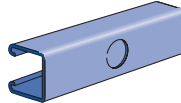

W/100 Ft: 170 Lbs (253 kg/100 m)

**P3000 SL**

**GR PG**

Slots are  
3" (76.2) x 1 3/8" (10.3)  
4" (101.6) on Center

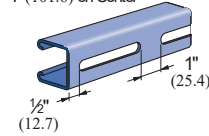

W/100 Ft: 165 Lbs (246 kg/100 m)

**P3000 T**

**GR PG**

Slots are  
1 1/8" (28.6) x 9/16" (14.3)  
2" (50.8) on Center

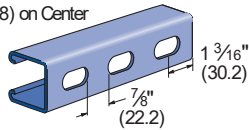

W/100 Ft: 165 Lbs (246 kg/100 m)

**P3000 WT**

**DF GR HG PG PL**

Slots are  
2" (50.8) x 1 1/16" (17.5)  
3" (76.2) on Center

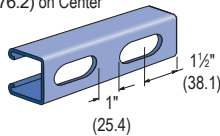

W/100 Ft: 165 Lbs (246 kg/100 m)

**CHANNEL NUTS** (REFER TO PAGES 73,74 FOR DETAILS)

**SEE PAGE 73, 74**



P1006-0832  
P1006-1024  
P1006-1420  
P1007  
P1008  
P1009  
P1010



P1008T  
P1006T1420  
P1010T



P1024  
P1012S  
P1023S



P3006-0832  
P3006-1024  
P3006-1420  
P3007  
P3008  
P3009  
P3010



P3016-0632  
P3016-0832  
P3016-1024  
P3016-1420



P1012  
P1023  
P1024S

Channel Finishes: PL, GR, HG, PG, ZD; Standard Lengths: 10' & 20'

## P3000 & P3001 Channels

### P3000 - BEAM LOADING

Span In	Max Allowable Uniform Load Lbs	Defl. at Uniform Load In	Uniform Loading at Deflection		
			Span/180 Lbs	Span/240 Lbs	Span/360 Lbs
24	1,280	0.07	1,280	1,280	1,280
36	850	0.15	850	850	580
48	640	0.26	640	490	330
60	510	0.41	420	310	210
72	430	0.59	290	220	150
84	370	0.81	210	160	110
96	320	1.05	160	120	80
108	280	1.30	130	100	60
120	260	1.66	100	80	50
144	210	2.32	70	50	40
168	180	3.15	50	40	30
192	160	4.18	40	30	NR
216	140	5.21	NR	NR	NR
240	130	6.64	NR	NR	NR

### P3001 - BEAM LOADING

Span In	Max Allowable Uniform Load Lbs	Defl. at Uniform Load In	Uniform Loading at Deflection		
			Span/180 Lbs	Span/240 Lbs	Span/360 Lbs
24	2,960*	0.03	2,960*	2,960*	2,960*
36	2,400	0.08	2,400	2,400	2,400
48	1,800	0.15	1,800	1,800	1,610
60	1,440	0.23	1,440	1,440	1,030
72	1,200	0.33	1,200	1,080	720
84	1,030	0.46	1,030	790	530
96	900	0.59	810	610	400
108	800	0.75	640	480	320
120	720	0.93	520	390	260
144	600	1.34	360	270	180
168	510	1.81	260	200	130
192	450	2.38	200	150	100
216	400	3.01	160	120	80
240	360	3.72	130	100	NR

### P3000 - COLUMN LOADING

Unbraced Height In	Maximum Allowable Load at Slot Face Lbs	Maximum Column Load Applied at C.G.			
		K = 0.65 Lbs	K = 0.80 Lbs	K = 1.0 Lbs	K = 1.2 Lbs
24	3,180	9,690	8,980	8,050	7,210
36	2,920	8,160	7,210	6,130	5,240
48	2,590	6,820	5,810	4,730	3,860
60	2,300	5,740	4,730	3,690	2,990
72	2,040	4,850	3,860	2,990	2,270
84	1,830	4,100	3,240	2,400	**
96	1,650	3,530	2,770	1,840	**
108	1,450	3,080	2,270	**	**
120	1,250	2,710	1,840	**	**

### P3001 - COLUMN LOADING

Unbraced Height In	Maximum Allowable Load at Slot Face Lbs	Maximum Column Load Applied at C.G.			
		K = 0.65 Lbs	K = 0.80 Lbs	K = 1.0 Lbs	K = 1.2 Lbs
24	5,740	21,780	21,200	20,430	19,720
36	5,620	20,520	19,720	18,830	17,680
48	5,520	19,400	18,570	16,570	14,260
60	5,330	18,510	16,570	13,670	10,810
72	5,030	16,850	14,260	10,810	7,730
84	4,630	14,990	11,930	8,180	5,680
96	4,190	13,090	9,720	6,260	4,350
108	3,720	11,230	7,730	4,950	**
120	3,300	9,460	6,260	4,010	**
144	2,620	6,590	4,350	**	**

### P3000/P3001 - ELEMENTS OF SECTION

Parameter	P3000		P3001	
Area of Section	0.500	In <sup>2</sup>	1.000	In <sup>2</sup>
Axis 1-1				
Moment of Inertia (I)	0.120	In <sup>4</sup>	0.591	In <sup>4</sup>
Section Modulus (S)	0.153	In <sup>3</sup>	0.430	In <sup>3</sup>
Radius of Gyration (r)	0.489	In	0.769	In
Axis 2-2				
Moment of Inertia (I)	0.203	In <sup>4</sup>	0.407	In <sup>4</sup>
Section Modulus (S)	0.250	In <sup>3</sup>	0.501	In <sup>3</sup>
Radius of Gyration (r)	0.638	In	0.638	In

#### Notes:

\* Load limited by spot weld shear.

\*\* KL/r > 200

NR = Not Recommended.

- Beam loads are given in total uniform load (W Lbs) not uniform load (w lbs/ft or w lbs/in).
- Beam loads are based on a simple span and assumed to be adequately laterally braced. Unbraced spans can reduce beam load carrying capacity. Refer to Page 62 for reduction factors for unbraced lengths.
- For pierced channel, multiply beam loads by the following factor:  
 "KO" Series .....95%                      "T" Series .....85%  
 "HS" Series .....90%                      "SL" Series .....85%  
 "WT" Series .....85%
- Deduct channel weight from the beam loads.
- For concentrated midspan point loads, multiply beam loads by 50% and the corresponding deflection by 80%. For other load conditions refer to page 18.
- All beam loads are for bending about Axis 1-1.



**P3000 - BEAM LOADING (METRIC)**

Span mm	Max Allowable Uniform Load kN	Defl. at Uniform Load mm	Uniform Loading at Deflection		
			Span/180 kN	Span/240 kN	Span/360 kN
600	5.8	2	5.8	5.8	5.8
750	4.6	3	4.6	4.6	3.8
1,000	3.5	4	3.5	3.2	2.2
1,250	2.8	7	2.8	2.1	1.4
1,500	2.3	10	1.9	1.4	1.0
1,750	2.0	14	1.4	1.1	0.7
2,000	1.7	18	1.1	0.8	0.5
2,500	1.4	28	0.7	0.5	0.4
3,000	1.2	40	0.5	0.4	0.2
3,500	1.0	54	0.4	0.3	0.2
4,000	0.9	73	0.3	0.2	0.1
4,500	0.8	89	0.2	0.2	NR
5,000	0.7	115	0.2	0.1	NR
6,000	0.6	161	NR	NR	NR

**P3001 - BEAM LOADING (METRIC)**

Span mm	Max Allowable Uniform Load kN	Defl. at Uniform Load mm	Uniform Loading at Deflection		
			Span/180 kN	Span/240 kN	Span/360 kN
600	13.2*	1	13.2*	13.2*	13.2*
750	13.0	1	13.0	13.0	13.0
1,000	9.8	3	9.8	9.8	9.8
1,250	7.8	4	7.8	7.8	6.9
1,500	6.5	6	6.5	6.5	4.8
1,750	5.6	8	5.6	5.2	3.5
2,000	4.9	10	4.9	4.0	2.7
2,500	3.9	16	3.4	2.6	1.7
3,000	3.2	23	2.4	1.8	1.2
3,500	2.8	31	1.7	1.3	0.9
4,000	2.4	41	1.3	1.0	0.7
4,500	2.2	52	1.1	0.8	0.5
5,000	2.0	64	0.8	0.6	0.4
6,000	1.6	92	0.6	0.4	0.3

**P3000 - COLUMN LOADING (METRIC)**

Unbraced Height mm	Maximum Allowable Load at Slot Face kN	Maximum Column Load Applied at C.G.			
		K = 0.65 kN	K = 0.80 kN	K = 1.0 kN	K = 1.2 kN
600	14.2	43.3	40.2	36.1	32.4
750	13.6	39.9	36.1	31.5	27.6
1,000	12.5	34.5	30.2	25.3	21.3
1,250	11.4	29.8	25.3	20.5	16.7
1,500	10.3	25.8	21.3	16.7	13.6
1,750	9.4	22.5	18.1	14.0	11.0
2,000	8.5	19.6	15.5	11.9	8.5
2,250	7.8	17.2	13.6	9.6	**
2,500	7.2	15.3	11.9	**	**
2,750	6.4	13.7	10.1	**	**

**P3001 - COLUMN LOADING (METRIC)**

Unbraced Height mm	Maximum Allowable Load at Slot Face kN	Maximum Column Load Applied at C.G.			
		K = 0.65 kN	K = 0.80 kN	K = 1.0 kN	K = 1.2 kN
600	25.5	97.1	94.5	91.1	88.0
750	25.3	94.3	91.1	87.3	84.0
1,000	24.9	89.8	86.1	82.2	74.5
1,250	24.6	85.8	82.2	72.4	61.8
1,500	23.8	82.6	74.5	61.8	49.2
1,750	22.8	77.0	66.1	51.3	37.5
2,000	21.4	70.3	57.6	41.3	28.7
2,250	19.9	63.4	49.2	32.7	22.7
2,500	18.2	56.5	41.3	26.5	18.4
2,750	16.5	49.8	34.2	21.9	**

**P3000/P3001 - ELEMENTS OF SECTION (METRIC)**

Parameter	P3000		P3001	
Area of Section	3.23	cm <sup>2</sup>	6.45	cm <sup>2</sup>
Axis 1-1				
Moment of Inertia (I)	4.97	cm <sup>4</sup>	24.61	cm <sup>4</sup>
Section Modulus (S)	2.51	cm <sup>3</sup>	7.05	cm <sup>3</sup>
Radius of Gyration (r)	1.24	cm	1.95	cm
Axis 2-2				
Moment of Inertia (I)	8.47	cm <sup>4</sup>	16.93	cm <sup>4</sup>
Section Modulus (S)	4.10	cm <sup>3</sup>	8.20	cm <sup>3</sup>
Radius of Gyration (r)	1.62	cm	1.62	cm

Notes:

\* Load limited by spot weld shear.

\*\* KL/r > 200

NR = Not Recommended.

- Beam loads are given in total uniform load (WLbs) not uniform load (w lbs/ft or w lbs/in).
- Beam loads are based on a simple span and assumed to be adequately laterally braced. Unbraced spans can reduce beam load carrying capacity. Refer to Page 62 for reduction factors for unbraced lengths.
- For pierced channel, multiply beam loads by the following factor:  
 "KO" Series ..... 95%                      "T" Series ..... 85%  
 "HS" Series ..... 90%                      "SL" Series ..... 85%  
 "WT" Series ..... 85%
- Deduct channel weight from the beam loads.
- For concentrated midspan point loads, multiply beam loads by 50% and the corresponding deflection by 80%. For other load conditions refer to page 18.
- All beam loads are for bending about Axis 1-1.

**P3300 & P3301 Channels**

**P3300**

**DF GR PG PL**

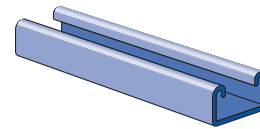
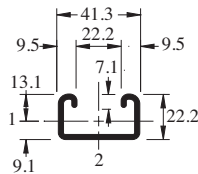
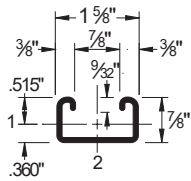

W/100 Ft: 134 Lbs (200 kg/100 m)  
Allowable Moment 1,800 In-Lbs (200 N·m)  
12 Gauge Nominal Thickness .105" (2.7mm)

**P3301**

**DF GR PG**

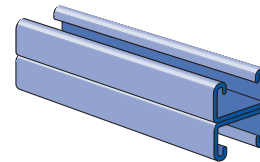
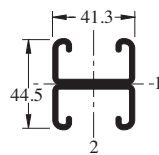
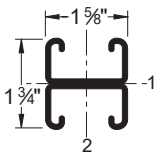

W/100 Ft: 269 Lbs (400 kg/100 m)  
Allowable Moment 5,060 In-Lbs (570 N·m)  
12 Gauge Nominal Thickness .105" (2.7mm)

**P3300 HS**

**GR PG**

9/16" (14.3) Dia. Holes  
1 7/8" (47.6) on Center

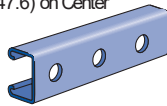

W/100 Ft: 130 Lbs (193 kg/100 m)

**P3300 T**

**DF GR PG**

Slots are  
1 1/8" (28.6) x 9/16" (14.3)  
2" (50.8) on Center

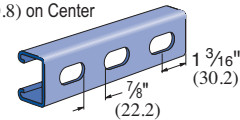

W/100 Ft: 130 Lbs (193 kg/100 m)

**P3300 SL**

**GR PG**

Slots are  
3" (76.2) x 1 3/32" (10.3)  
4" (101.6) on Center

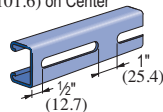

W/100 Ft: 130 Lbs (193 kg/100 m)

**P3300 WT**

**DF GR HG PG PL**

Slots are  
2" (50.8) x 1 1/16" (17.5)  
3" (76.2) on Center

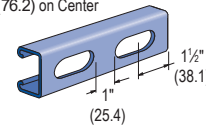

W/100 Ft: 130 Lbs (193 kg/100 m)

**CHANNEL NUTS (REFER TO PAGES 73,74 FOR DETAILS)**

**SEE PAGE 73, 74**



P4006-0832  
P4006-1024  
P4006-1420  
P4007  
P4008  
P4009  
P4010



P4010T



P4012  
P4023



P3006-0832  
P3006-1024  
P3006-1420  
P3007  
P3008  
P3009  
P3013



P3016-0632  
P3016-0832  
P3016-1024  
P3016-1420

Channel Finishes: DF, PL, GR, HG, PG, ZD; Standard Lengths: 10' & 20'



**P3300 - BEAM LOADING**

Span In	Max Allowable Uniform Load Lbs	Defl. at Uniform Load In	Uniform Loading at Deflection		
			Span/180 Lbs	Span/240 Lbs	Span/360 Lbs
24	600	0.10	600	600	400
36	400	0.22	360	270	180
48	300	0.40	200	150	100
60	240	0.62	130	100	60
72	200	0.89	90	70	40
84	170	1.20	70	50	30
96	150	1.59	50	40	30
108	130	1.96	40	30	20
120	120	2.48	30	20	20

**P3301 - BEAM LOADING**

Span In	Max Allowable Uniform Load Lbs	Defl. at Uniform Load In	Uniform Loading at Deflection		
			Span/180 Lbs	Span/240 Lbs	Span/360 Lbs
24	1,690	0.06	1,690	1,690	1,690
36	1,130	0.13	1,130	1,130	860
48	840	0.23	840	720	480
60	680	0.37	620	460	310
72	560	0.52	430	320	210
84	480	0.71	310	240	160
96	420	0.93	240	180	120
108	380	1.20	190	140	100
120	340	1.47	150	120	80
144	280	2.09	110	80	50

**P3300 - COLUMN LOADING**

Unbraced Height In	Maximum Allowable Load at Slot Face Lbs	Maximum Column Load Applied at C.G.			
		K = 0.65 Lbs	K = 0.80 Lbs	K = 1.0 Lbs	K = 1.2 Lbs
24	2,360	7,740	7,260	6,350	5,390
36	2,120	6,470	5,390	3,990	2,810
48	1,760	4,910	3,550	2,270	1,580
60	1,380	3,440	2,270	1,460	**
72	1,080	2,390	1,580	**	**

**P3301 - COLUMN LOADING**

Unbraced Height In	Maximum Allowable Load at Slot Face Lbs	Maximum Column Load Applied at C.G.			
		K = 0.65 Lbs	K = 0.80 Lbs	K = 1.0 Lbs	K = 1.2 Lbs
24	4,290	16,990	16,580	15,770	14,720
36	4,150	15,890	14,720	12,980	11,120
48	3,940	14,160	12,360	9,880	7,510
60	3,650	12,210	9,880	6,940	4,820
72	3,270	10,190	7,510	4,820	3,350
84	2,800	8,220	5,530	3,540	**
96	2,410	6,420	4,240	**	**
108	2,080	5,070	3,350	**	**

**P3300/P3301 - ELEMENTS OF SECTION**

Parameter	P3300		P3301	
	Value	Unit	Value	Unit
Area of Section	0.395	In <sup>2</sup>	0.790	In <sup>2</sup>
Axis 1-1				
Moment of Inertia (I)	0.037	In <sup>4</sup>	0.176	In <sup>4</sup>
Section Modulus (S)	0.072	In <sup>3</sup>	0.201	In <sup>3</sup>
Radius of Gyration (r)	0.306	In	0.472	In
Axis 2-2				
Moment of Inertia (I)	0.143	In <sup>4</sup>	0.285	In <sup>4</sup>
Section Modulus (S)	0.176	In <sup>3</sup>	0.351	In <sup>3</sup>
Radius of Gyration (r)	0.601	In	0.601	In

Notes:

\* Load limited by spot weld shear.

\*\* KL/r > 200

NR = Not Recommended.

- Beam loads are given in total uniform load (WLbs) not uniform load (w lbs/ft or w lbs/in).
- Beam loads are based on a simple span and assumed to be adequately laterally braced. Unbraced spans can reduce beam load carrying capacity. Refer to Page 62 for reduction factors for unbraced lengths.
- For pierced channel, multiply beam loads by the following factor:  
 "KO" Series ..... 95%                      "T" Series ..... 85%  
 "HS" Series ..... 90%                      "SL" Series ..... 85%  
 "WT" Series ..... 85%
- Deduct channel weight from the beam loads.
- For concentrated midspan point loads, multiply beam loads by 50% and the corresponding deflection by 80%. For other load conditions refer to page 18.
- All beam loads are for bending about Axis 1-1.



# P3300 & P3301 Channels

## P3300 - BEAM LOADING (METRIC)

Span mm	Max Allowable Uniform Load kN	Defl. at Uniform Load mm	Uniform Loading at Deflection		
			Span/180 kN	Span/240 kN	Span/360 kN
600	2.7	2	2.7	2.7	1.9
750	2.2	4	2.2	1.8	1.2
1,000	1.6	7	1.3	1.0	0.7
1,250	1.3	10	0.8	0.6	0.4
1,500	1.1	15	0.6	0.4	0.3
1,750	0.9	21	0.4	0.3	0.2
2,000	0.8	27	0.3	0.3	0.2
2,500	0.7	43	0.2	0.2	0.1
3,000	0.5	60	0.1	0.1	0.1
3,500	0.4	79	0.1	0.1	NR

## P3301 - BEAM LOADING (METRIC)

Span mm	Max Allowable Uniform Load kN	Defl. at Uniform Load mm	Uniform Loading at Deflection		
			Span/180 kN	Span/240 kN	Span/360 kN
600	7.6	1	7.6	7.6	7.6
750	6.1	2	6.1	6.1	5.6
1,000	4.6	4	4.6	4.6	3.2
1,250	3.6	6	3.6	3.1	2.0
1,500	3.1	9	2.8	2.1	1.4
1,750	2.6	12	2.1	1.6	1.0
2,000	2.3	16	1.6	1.2	0.8
2,500	1.8	25	1.0	0.8	0.5
3,000	1.5	36	0.7	0.5	0.4
3,500	1.3	48	0.5	0.4	0.3
4,000	1.2	65	0.4	0.3	0.2

## P3300 - COLUMN LOADING (METRIC)

Unbraced Height mm	Maximum Allowable Load at Slot Face kN	Maximum Column Load Applied at C.G.			
		K = 0.65 kN	K = 0.80 kN	K = 1.0 kN	K = 1.2 kN
600	10.5	34.6	32.6	28.6	24.4
750	10.1	32.3	28.6	23.3	18.2
1,000	9.1	26.9	21.6	15.0	10.5
1,250	7.6	21.2	15.0	9.6	6.7
1,500	6.3	15.8	10.5	6.7	**
1,750	5.1	11.6	7.6	**	**

## P3301 - COLUMN LOADING (METRIC)

Unbraced Height mm	Maximum Allowable Load at Slot Face kN	Maximum Column Load Applied at C.G.			
		K = 0.65 kN	K = 0.80 kN	K = 1.0 kN	K = 1.2 kg
600	19.1	75.7	73.9	70.5	66.0
750	18.9	73.8	70.5	64.7	58.4
1,000	18.2	68.6	62.7	53.9	44.8
1,250	17.4	62.1	53.9	42.6	31.9
1,500	16.4	55.0	44.8	31.9	22.2
1,750	15.0	47.6	36.0	23.4	16.3
2,000	13.3	40.3	28.0	17.9	**
2,250	11.8	33.4	22.2	14.1	**
2,500	10.4	27.2	17.9	**	**
2,750	9.2	22.5	14.8	**	**

## P3300/P3301 - ELEMENTS OF SECTION (METRIC)

Parameter	P3300		P3301	
Area of Section	2.55	cm <sup>2</sup>	5.10	cm <sup>2</sup>
Axis 1-1				
Moment of Inertia (I)	1.54	cm <sup>4</sup>	7.33	cm <sup>4</sup>
Section Modulus (S)	1.18	cm <sup>3</sup>	3.30	cm <sup>3</sup>
Radius of Gyration (r)	0.78	cm	1.20	cm
Axis 2-2				
Moment of Inertia (I)	5.94	cm <sup>4</sup>	11.87	cm <sup>4</sup>
Section Modulus (S)	2.88	cm <sup>3</sup>	5.75	cm <sup>3</sup>
Radius of Gyration (r)	1.53	cm	1.53	cm

### Notes:

\* Load limited by spot weld shear.

\*\* KL/r > 200

NR = Not Recommended.

- Beam loads are given in total uniform load (W Lbs) not uniform load (w lbs/ft or w lbs/in).
- Beam loads are based on a simple span and assumed to be adequately laterally braced. Unbraced spans can reduce beam load carrying capacity. Refer to Page 62 for reduction factors for unbraced lengths.
- For pierced channel, multiply beam loads by the following factor:  
 "KO" Series .....95%                      "T" Series .....85%  
 "HS" Series .....90%                      "SL" Series .....85%  
 "WT" Series .....85%
- Deduct channel weight from the beam loads.
- For concentrated midspan point loads, multiply beam loads by 50% and the corresponding deflection by 80%. For other load conditions refer to page 18.
- All beam loads are for bending about Axis 1-1.

1 1/8" Channel  
 Telestrut  
 Nuts & Hardware  
 General Fittings  
 Pipe/Conduit Supports  
 Electrical Fittings  
 Concrete Inserts  
 Unipier®



1 1/8" Channel  
 Telestrut  
 Nuts & Hardware  
 General Fittings  
 Supports  
 Pipe/Conduit  
 Electrical Fittings  
 Inserts  
 Concrete  
 Solar  
 Unipier®

**P4000**

**HG PG GR**

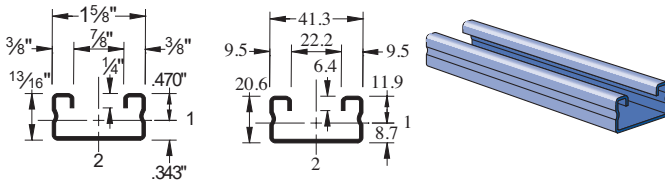

Ww/100 Ft: 83 Lbs (123 kg/100 m)  
 Allowable Moment 1,230 In-Lbs (140 N•m)  
 16 Gauge Nominal Thickness .060" (1.5mm)

**P4001**

**GR PG**

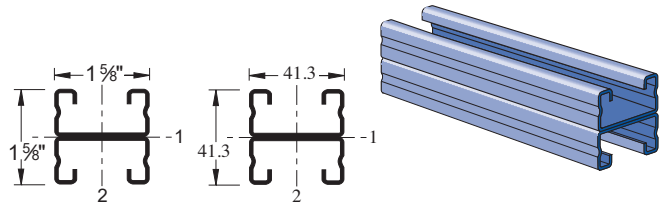

Ww/100 Ft: 166 Lbs (246 kg/100 m)  
 Allowable Moment 3,210 In-Lbs (360 N•m)  
 16 Gauge Nominal Thickness .060" (1.5mm)

**P4003**

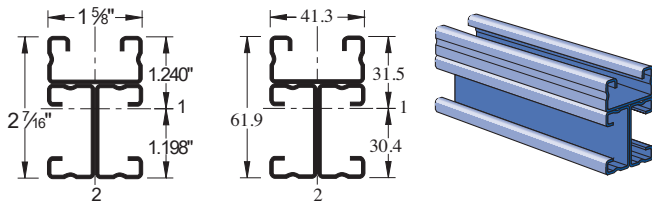

Ww/100 Ft: 248 Lbs (370 kg/100 m)  
 Allowable Moment 8,600 In-Lbs (970 N•m)  
 16 Gauge Nominal Thickness .060" (1.5mm)

**P4004**

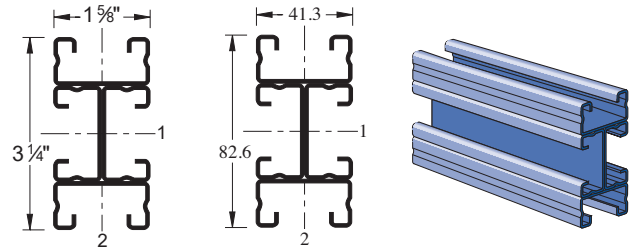

Ww/100 Ft: 331 Lbs (493 kg/100 m)  
 Allowable Moment 13,650 In-Lbs (1,540 N•m)  
 16 Gauge Nominal Thickness .060" (1.5mm)

**P4000 HS**

**GR PG**

9/16" (14.3) Dia. Holes  
 1 7/8" (47.6) on Center

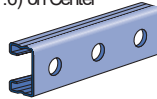

Ww/100 Ft: 79 Lbs (118 kg/100 m)

**P4000 T**

**GR PG**

Slots are  
 1 1/8" (28.6) x 9/16" (14.3)  
 2" (50.8) on Center

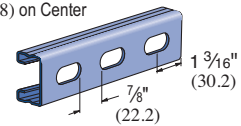

Ww/100 Ft: 79 Lbs (118 kg/100 m)

**P4000 SL**

**GR PG**

Slots are  
 3" (76.2) x 1 3/32" (10.3)  
 4" (101.6) on Center

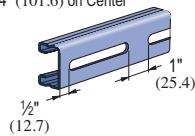

Ww/100 Ft: 79 Lbs (118 kg/100 m)

**P4000 WT**

**DF GR HG PG PL**

Slots are  
 2" (50.8) x 1 1/16" (17.5)  
 3" (76.2) on Center

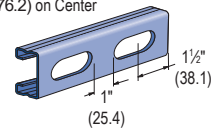

Ww/100 Ft: 79 Lbs (118 kg/100 m)

**CHANNEL NUTS (REFER TO PAGES 73,74 FOR DETAILS)**

**SEE PAGE 73, 74**



P4006-0832  
 P4006-1024  
 P4006-1420  
 P4007  
 P4008  
 P4009  
 P4010



P4010T



P4012  
 P4023



P3006-0832  
 P3006-1024  
 P3006-1420  
 P3007  
 P3008  
 P3009  
 P3013



P3016-0632  
 P3016-0832  
 P3016-1024  
 P3016-1420

Channel Finishes: PL, GR, HG, PG, ZD; Standard Lengths: 10' & 20'

**P4000 & P4001 Channels**

**P4000 - BEAM LOADING**

Span In	Max Allowable Uniform Load Lbs	Defl. at Uniform Load In	Uniform Loading at Deflection		
			Span/180 Lbs	Span/240 Lbs	Span/360 Lbs
24	410	0.11	410	370	250
36	270	0.24	220	170	110
48	200	0.43	120	90	60
60	160	0.67	80	60	40
72	140	1.01	60	40	30
84	120	1.38	40	30	20
96	100	1.72	30	20	20
108	90	2.20	20	20	10
120	80	2.68	20	10	10

**P4001 - BEAM LOADING**

Span In	Max Allowable Uniform Load Lbs	Defl. at Uniform Load In	Uniform Loading at Deflection		
			Span/180 Lbs	Span/240 Lbs	Span/360 Lbs
24	810*	0.05	810*	810*	810*
36	710	0.14	710	710	500
48	540	0.25	540	430	280
60	430	0.40	360	270	180
72	360	0.57	250	190	130
84	310	0.78	190	140	90
96	270	1.02	140	110	70
108	240	1.29	110	80	60
120	210	1.54	90	70	50
144	180	2.29	60	50	30

**P4000 - COLUMN LOADING**

Unbraced Height In	Maximum Allowable Load at Slot Face Lbs	Maximum Column Load Applied at C.G.			
		K = 0.65 Lbs	K = 0.80 Lbs	K = 1.0 Lbs	K = 1.2 Lbs
24	1,630	4,670	4,290	3,780	3,310
36	1,450	3,840	3,310	2,460	1,730
48	1,160	3,030	2,190	1,400	970
60	870	2,120	1,400	900	**
72	670	1,470	970	**	**

**P4001 - COLUMN LOADING**

Unbraced Height In	Maximum Allowable Load at Slot Face Lbs	Maximum Column Load Applied at C.G.			
		K = 0.65 Lbs	K = 0.80 Lbs	K = 1.0 Lbs	K = 1.2 Lbs
24	2,830	10,390	10,000	9,470	8,960
36	2,740	9,530	8,960	7,870	6,700
48	2,590	8,620	7,480	5,910	4,440
60	2,340	7,380	5,910	4,090	2,840
72	2,020	6,110	4,440	2,840	1,970
84	1,700	4,880	3,260	2,090	**
96	1,440	3,780	2,500	**	**
108	1,230	2,990	1,970	**	**

**P4000/P4001 - ELEMENTS OF SECTION**

Parameter	P4000		P4001	
Area of Section	0.244	In <sup>2</sup>	0.487	In <sup>2</sup>
Axis 1-1				
Moment of Inertia (I)	0.023	In <sup>4</sup>	0.104	In <sup>4</sup>
Section Modulus (S)	0.049	In <sup>3</sup>	0.128	In <sup>3</sup>
Radius of Gyration (r)	0.306	In	0.462	In
Axis 2-2				
Moment of Inertia (I)	0.092	In <sup>4</sup>	0.183	In <sup>4</sup>
Section Modulus (S)	0.113	In <sup>3</sup>	0.225	In <sup>3</sup>
Radius of Gyration (r)	0.613	In	0.613	In

Notes:

\* Load limited by spot weld shear.

\*\* KL/r > 200

NR = Not Recommended.

- Beam loads are given in total uniform load (W Lbs) not uniform load (w lbs/ft or w lbs/in).
- Beam loads are based on a simple span and assumed to be adequately laterally braced. Unbraced spans can reduce beam load carrying capacity. Refer to Page 62 for reduction factors for unbraced lengths.
- For pierced channel, multiply beam loads by the following factor:  
"KO" Series .....95%                      "T" Series .....85%  
"HS" Series .....90%                      "SL" Series .....85%  
"WT" Series .....85%
- Deduct channel weight from the beam loads.
- For concentrated midspan point loads, multiply beam loads by 50% and the corresponding deflection by 80%. For other load conditions refer to page 18.
- All beam loads are for bending about Axis 1-1.

1 1/8" Channel  
Telestrut  
Nuts & Hardware  
General Fittings  
Pipe/Conduit Supports  
Electrical Fittings  
Concrete Inserts  
Solar  
Unipier®



1 1/8" Channel

Telestrut

Nuts & Hardware

General Fittings

Pipe/Conduit Supports

Electrical Fittings

Concrete Inserts

Solar

Unipier®

**P4000 - BEAM LOADING (METRIC)**

Span mm	Max Allowable Uniform Load kN	Defl. at Uniform Load mm	Uniform Loading at Deflection		
			Span/180 kN	Span/240 kN	Span/360 kN
600	1.9	3	1.9	1.7	1.2
750	1.5	4	1.5	1.1	0.7
1,000	1.1	8	0.8	0.6	0.4
1,250	0.9	12	0.5	0.4	0.3
1,500	0.8	17	0.4	0.3	0.2
1,750	0.6	23	0.3	0.2	0.1
2,000	0.5	29	0.2	0.1	0.1
2,500	0.4	47	0.1	0.1	NR
3,000	0.4	65	0.1	0.1	NR

**P4001 - BEAM LOADING (METRIC)**

Span mm	Max Allowable Uniform Load kN	Defl. at Uniform Load mm	Uniform Loading at Deflection		
			Span/180 kN	Span/240 kN	Span/360 kN
600	3.6*	1	3.6*	3.6*	3.6*
750	3.6*	2	3.6*	3.6*	3.3
1,000	2.9	4	2.9	2.8	1.9
1,250	2.3	7	2.3	1.8	1.2
1,500	2.0	10	1.6	1.2	0.8
1,750	1.6	13	1.2	0.9	0.6
2,000	1.5	17	0.9	0.7	0.5
2,500	1.2	27	0.6	0.4	0.3
3,000	1.0	39	0.4	0.3	0.2
3,500	0.8	54	0.3	0.2	0.1

**P4000 - COLUMN LOADING (METRIC)**

Unbraced Height mm	Maximum Al- lowable Load at Slot Face kN	Maximum Column Load Applied at C.G.			
		K = 0.65 kN	K = 0.80 kN	K = 1.0 kN	K = 1.2 kN
600	7.2	20.9	19.2	17.0	14.9
750	6.9	19.1	17.0	14.4	11.3
1,000	6.1	16.1	13.3	9.2	6.5
1,250	5.0	13.0	9.2	5.9	4.1
1,500	4.0	9.7	6.5	4.1	**
1,750	3.2	7.2	4.7	**	**

**P4001 - COLUMN LOADING (METRIC)**

Unbraced Height mm	Maximum Allowable Load at Slot Face kN	Maximum Column Load Applied at C.G.			
		K = 0.65 kN	K = 0.80 kN	K = 1.0 kN	K = 1.2 kN
600	12.6	46.3	44.6	42.3	40.0
750	12.4	44.5	42.3	39.5	35.4
1,000	12.1	41.3	38.2	32.6	26.9
1,250	11.4	37.8	32.6	25.4	18.8
1,500	10.5	33.3	26.9	18.8	13.0
1,750	9.4	28.6	21.3	13.8	9.6
2,000	8.1	24.1	16.5	10.5	**
2,250	7.1	19.8	13.0	8.4	**
2,500	6.2	16.0	10.5	**	**
2,750	5.4	13.2	8.7	**	**

**P4000/P4001 - ELEMENTS OF SECTION (METRIC)**

Parameter	P4000		P4001	
Area of Section	1.57	cm <sup>2</sup>	3.14	cm <sup>2</sup>
Axis 1-1				
Moment of Inertia (I)	0.95	cm <sup>4</sup>	4.32	cm <sup>4</sup>
Section Modulus (S)	0.80	cm <sup>3</sup>	2.09	cm <sup>3</sup>
Radius of Gyration (r)	0.78	cm	1.17	cm
Axis 2-2				
Moment of Inertia (I)	3.81	cm <sup>4</sup>	7.62	cm <sup>4</sup>
Section Modulus (S)	1.85	cm <sup>3</sup>	3.69	cm <sup>3</sup>
Radius of Gyration (r)	1.56	cm	1.56	cm

Notes:

\* Load limited by spot weld shear.

\*\* KL/r > 200

NR = Not Recommended.

- Beam loads are given in total uniform load (WLbs) not uniform load (w lbs/ft or w lbs/in).
- Beam loads are based on a simple span and assumed to be adequately laterally braced. Unbraced spans can reduce beam load carrying capacity. Refer to Page 62 for reduction factors for unbraced lengths.
- For pierced channel, multiply beam loads by the following factor:  
 "KO" Series ..... 95%                      "T" Series ..... 85%  
 "HS" Series ..... 90%                      "SL" Series ..... 85%  
 "WT" Series ..... 85%
- Deduct channel weight from the beam loads.
- For concentrated midspan point loads, multiply beam loads by 50% and the corresponding deflection by 80%. For other load conditions refer to page 18.
- All beam loads are for bending about Axis 1-1.

**P4100 & P4101 Channels**

**P4100**

DF GR PG

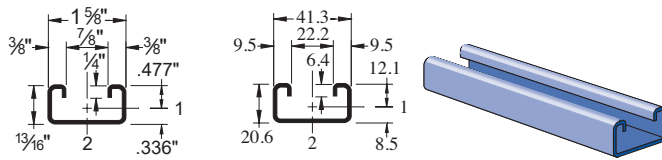

W/100 Ft: 98 Lbs (147 kg/100 m)  
Allowable Moment 1,360 In-Lbs (150 N·m)  
14 Gauge Nominal Thickness .075" (1.9mm)

**P4101**

DF GR PG

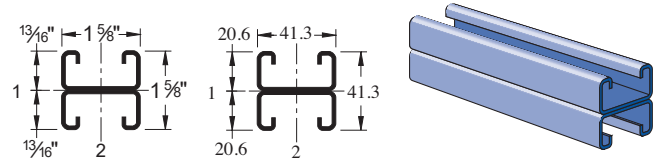

W/100 Ft: 197 Lbs (293 kg/100 m)  
Allowable Moment 3,610 In-Lbs (410 N·m)  
14 Gauge Nominal Thickness .075" (1.9mm)

**P4100 HS**

GR PG

5/16" (14.3) Dia. Holes  
1 7/8" (47.6) on Center

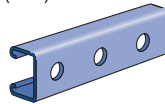

W/100 Ft: 87 Lbs (129 kg/100 m)

**P4100 T**

DF GR PG

Slots are  
1 1/8" (28.6) x 9/16" (14.3)  
2" (50.8) on Center

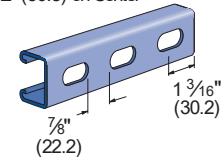

W/100 Ft: 87 Lbs (129 kg/100 m)

**P4100 SL**

GR PG

Slots are  
3" (76.2) x 1 3/32" (10.3)  
4" (101.6) on Center

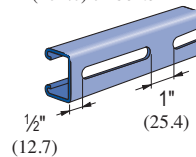

W/100 Ft: 87 Lbs (129 kg/100 m)

**P4100 WT**

DF GR HG PG PL

Slots are  
2" (50.8) x 1 1/16" (17.5)  
3" (76.2) on Center

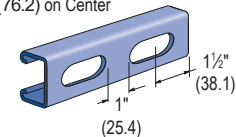

W/100 Ft: 87 Lbs (129 kg/100 m)

**P4101 T**

Slots are  
1 1/8" (28.6) x 9/16" (14.3)  
2" (50.8) on Center

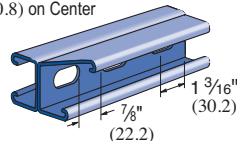

W/100 Ft: 174 Lbs (259 kg/100 m)

**P4101 WT**

DF GR HG PG PL

Slots are  
2" (50.8) x 1 1/16" (17.5)  
3" (76.2) on Center

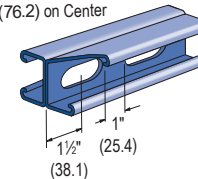

W/100 Ft: 174 Lbs (259 kg/100 m)

**CHANNEL NUTS (REFER TO PAGES 73,74 FOR DETAILS)**

SEE PAGE 73, 74



P4006-0832  
P4006-1024  
P4006-1420  
P4007  
P4008  
P4009  
P4010



P4010T



P4012  
P4023



P3006-0832  
P3006-1024  
P3006-1420  
P3007  
P3008  
P3009  
P3013



P3016-0632  
P3016-0832  
P3016-1024  
P3016-1420

Channel Finishes: DF, PL, GR, HG, PG, ZD; Standard Lengths: 10' & 20'



1 1/8" Channel

Telestrut

Nuts & Hardware

General Fittings

Pipe/Conduit Supports

Electrical Fittings

Concrete Inserts

Solar

Unipier®

**P4100 - BEAM LOADING**

Span In	Max Allowable Uniform Load Lbs	Defl. at Uniform Load In	Uniform Loading at Deflection		
			Span/180 Lbs	Span/240 Lbs	Span/360 Lbs
24	450	0.11	450	420	280
36	300	0.24	250	190	130
48	230	0.44	140	110	70
60	180	0.67	90	70	50
72	150	0.96	60	50	30
84	130	1.32	50	30	20
96	110	1.67	40	30	20
108	100	2.16	30	20	10
120	90	2.67	20	20	10
144	80	4.09	20	NR	NR
168	60	4.88	NR	NR	NR
192	60	7.28	NR	NR	NR
216	50	8.64	NR	NR	NR
240	50	11.85	NR	NR	NR

**P4101 - BEAM LOADING**

Span In	Max Allowable Uniform Load Lbs	Defl. at Uniform Load In	Uniform Loading at Deflection		
			Span/180 Lbs	Span/240 Lbs	Span/360 Lbs
24	1,090*	0.06	1,090*	1,090*	1,090*
36	800	0.14	800	800	570
48	600	0.25	600	480	320
60	480	0.39	410	310	200
72	400	0.57	280	210	140
84	340	0.76	210	160	100
96	300	1.00	160	120	80
108	270	1.29	130	90	60
120	240	1.57	100	80	50
144	200	2.26	70	50	40
168	170	3.05	50	40	30
192	150	4.02	40	NR	NR
216	130	4.96	NR	NR	NR
240	120	6.28	NR	NR	NR

**P4100 - COLUMN LOADING**

Unbraced Height In	Maximum Allowable Load at Slot Face Lbs	Maximum Column Load Applied at C.G.			
		K = 0.65 Lbs	K = 0.80 Lbs	K = 1.0 Lbs	K = 1.2 Lbs
24	1,840	5,610	5,210	4,570	3,850
36	1,640	4,660	3,850	2,800	1,960
48	1,310	3,490	2,480	1,590	1,100
60	1,000	2,400	1,590	**	**
72	770	1,670	1,100	**	**

**P4101 - COLUMN LOADING**

Unbraced Height In	Maximum Allowable Load at Slot Face Lbs	Maximum Column Load Applied at C.G.			
		K = 0.65 Lbs	K = 0.80 Lbs	K = 1.0 Lbs	K = 1.2 Lbs
24	3,240	12,370	11,950	11,370	10,540
36	3,120	11,470	10,540	9,160	7,720
48	2,940	10,090	8,680	6,770	4,980
60	2,680	8,560	6,770	4,590	3,190
72	2,310	7,010	4,980	3,190	2,220
84	1,950	5,530	3,660	2,340	**
96	1,650	4,250	2,800	**	**
108	1,410	3,360	2,220	**	**

**P4100/P4101 - ELEMENTS OF SECTION**

Parameter	P4100		P4101	
Area of Section	0.290	In <sup>2</sup>	0.579	In <sup>2</sup>
Axis 1-1				
Moment of Inertia (I)	0.026	In <sup>4</sup>	0.117	In <sup>4</sup>
Section Modulus (S)	0.054	In <sup>3</sup>	0.143	In <sup>3</sup>
Radius of Gyration (r)	0.298	In	0.449	In
Axis 2-2				
Moment of Inertia (I)	0.107	In <sup>4</sup>	0.214	In <sup>4</sup>
Section Modulus (S)	0.132	In <sup>3</sup>	0.264	In <sup>3</sup>
Radius of Gyration (r)	0.609	In	0.608	In

Notes:

\* Load limited by spot weld shear.

\*\* KL/r > 200

NR = Not Recommended.

- Beam loads are given in total uniform load (WLbs) not uniform load (w lbs/ft or w lbs/in).
- Beam loads are based on a simple span and assumed to be adequately laterally braced. Unbraced spans can reduce beam load carrying capacity. Refer to Page 62 for reduction factors for unbraced lengths.
- For pierced channel, multiply beam loads by the following factor:  
 "KO" Series ..... 95%                      "T" Series ..... 85%  
 "HS" Series ..... 90%                      "SL" Series ..... 85%  
 "WT" Series ..... 85%
- Deduct channel weight from the beam loads.
- For concentrated midspan point loads, multiply beam loads by 50% and the corresponding deflection by 80%. For other load conditions refer to page 18.
- All beam loads are for bending about Axis 1-1.

## P4100 & P4101 Channels

### P4100 - BEAM LOADING (METRIC)

Span mm	Max Allowable Uniform Load kN	Defl. at Uniform Load mm	Uniform Loading at Deflection		
			Span/180 kN	Span/240 kN	Span/360 kN
600	2.0	3	2.0	2.0	1.3
750	1.6	4	1.6	1.2	0.8
1,000	1.2	7	0.9	0.7	0.4
1,250	1.0	11	0.6	0.4	0.3
1,500	0.8	16	0.4	0.3	0.2
1,750	0.7	23	0.3	0.2	0.1
2,000	0.6	30	0.2	0.2	0.1
2,500	0.5	46	0.1	0.1	0.1
3,000	0.4	65	0.1	0.1	NR

### P4101 - BEAM LOADING (METRIC)

Span mm	Max Allowable Uniform Load kN	Defl. at Uniform Load mm	Uniform Loading at Deflection		
			Span/180 kN	Span/240 kN	Span/360 kN
600	4.8*	1	4.8*	4.8*	4.8*
750	4.4	2	4.4	4.4	3.7
1,000	3.2	4	3.2	3.2	2.1
1,250	2.6	7	2.6	2.0	1.3
1,500	2.2	10	1.9	1.4	0.9
1,750	1.9	13	1.4	1.0	0.7
2,000	1.6	17	1.1	0.8	0.5
2,500	1.3	27	0.7	0.5	0.4
3,000	1.1	38	0.5	0.4	0.2
3,500	0.9	53	0.4	0.3	0.2

### P4100 - COLUMN LOADING (METRIC)

Unbraced Height mm	Maximum Allowable Load at Slot Face kN	Maximum Column Load Applied at C.G.			
		K = 0.65 kN	K = 0.80 kN	K = 1.0 kN	K = 1.2 kN
600	8.2	25.1	23.3	20.6	17.4
750	7.8	23.2	20.6	16.6	12.8
1,000	6.9	19.3	15.3	10.5	7.3
1,250	5.6	15.0	10.5	6.7	4.7
1,500	4.5	11.0	7.3	4.7	**
1,750	3.6	8.1	5.3	**	**

### P4101 - COLUMN LOADING (METRIC)

Unbraced Height mm	Maximum Allowable Load at Slot Face kN	Maximum Column Load Applied at C.G.			
		K = 0.65 kN	K = 0.80 kN	K = 1.0 kN	K = 1.2 kN
600	14.4	55.1	53.3	50.8	47.2
750	14.2	53.2	50.8	46.3	41.2
1,000	13.7	49.4	44.7	37.8	30.8
1,250	13.0	44.2	37.8	29.1	21.1
1,500	12.0	38.7	30.8	21.1	14.6
1,750	10.7	33.0	24.2	15.5	10.8
2,000	9.3	27.4	18.5	11.9	**
2,250	8.1	22.2	14.6	9.4	**

### P4100/P4101 - ELEMENTS OF SECTION (METRIC)

Parameter	P4100	P4101
Area of Section	1.87 cm <sup>2</sup>	3.74 cm <sup>2</sup>
Axis 1-1		
Moment of Inertia (I)	1.07 cm <sup>4</sup>	4.85 cm <sup>4</sup>
Section Modulus (S)	0.88 cm <sup>3</sup>	2.35 cm <sup>3</sup>
Radius of Gyration (r)	0.76 cm	1.14 cm
Axis 2-2		
Moment of Inertia (I)	4.46 cm <sup>4</sup>	8.93 cm <sup>4</sup>
Section Modulus (S)	2.16 cm <sup>3</sup>	4.32 cm <sup>3</sup>
Radius of Gyration (r)	1.55 cm	1.55 cm

#### Notes:

\* Load limited by spot weld shear.

\*\* KL/r > 200

NR = Not Recommended.

- Beam loads are given in total uniform load (W Lbs) not uniform load (w lbs/ft or w lbs/in).
- Beam loads are based on a simple span and assumed to be adequately laterally braced. Unbraced spans can reduce beam load carrying capacity. Refer to Page 62 for reduction factors for unbraced lengths.
- For pierced channel, multiply beam loads by the following factor:  

"KO" Series .....	95%	"T" Series .....	85%
"HS" Series .....	90%	"SL" Series .....	85%
"WT" Series .....	85%		
- Deduct channel weight from the beam loads.
- For concentrated midspan point loads, multiply beam loads by 50% and the corresponding deflection by 80%. For other load conditions refer to page 18.
- All beam loads are for bending about Axis 1-1.



1 5/8" Channel

Telestrut

Nuts & Hardware

General Fittings

Pipe/Conduit Supports

Electrical Fittings

Concrete Inserts

Solar

Unipier®

**P4400**

GR PG

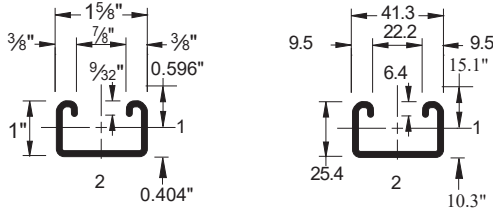
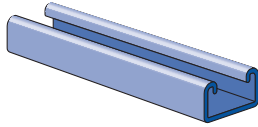

W/100 Ft: 144 Lbs (210 kg/100 m)  
Allowable Moment 2,300 In-Lbs (260 N•m)  
12 Gauge Nominal Thickness .105" (2.7mm)

**P4401**

GR PG

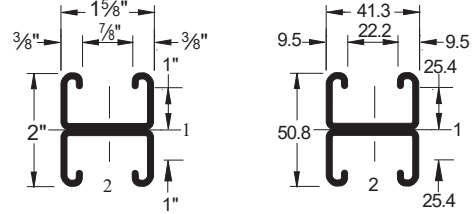
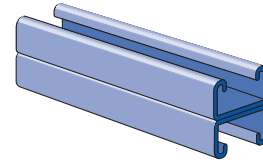

W/100 Ft: 289 Lbs (430 kg/100 m)  
Allowable Moment 6,410 In-Lbs (725 N•m)  
12 Gauge Nominal Thickness .105" (2.7mm)

**P4400 HS**

GR PG

9/16" (14.3) Dia. Holes  
1 7/8" (47.6) on Center

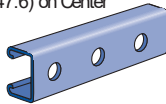

W/100 Ft: 136 Lbs (201 kg/100 m)

**P4400 T**

GR PG

Slots are  
1 1/8" (28.6) x 9/16" (14.3)  
2" (50.8) on Center

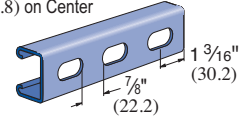

W/100 Ft: 136 Lbs (201 kg/100 m)

**P4400 SL**

GR PG

Slots are  
3" (76.2) x 1 3/32" (10.3)  
4" (101.6) on Center

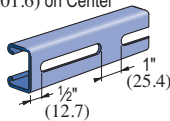

W/100 Ft: 136 Lbs (201 kg/100 m)

**P4400 WT**

DF GR HG PG PL

Slots are  
2" (50.8) x 1 1/16" (17.5)  
3" (76.2) on Center

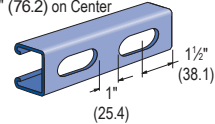

W/100 Ft: 136 Lbs (201 kg/100 m)

**CHANNEL NUTS** (REFER TO PAGES 73,74 FOR DETAILS)

SEE PAGE 73, 74



P4006-0832  
P4006-1024  
P4006-1420  
P4007  
P4008  
P4009  
P4010



P4010T



P4012  
P4023



P3006-0832  
P3006-1024  
P3006-1420  
P3007  
P3008  
P3009  
P3013



P3016-0632  
P3016-0832  
P3016-1024  
P3016-1420

Channel Finishes: PL, GR, HG, PG, ZD; Standard Lengths: 10' & 20'



# P4400 & P4401 Channels

## P4400 - BEAM LOADING

Span In	Max Allowable Uniform Load Lbs	Defl. at Uniform Load In	Uniform Loading at Deflection		
			Span/180 Lbs	Span/240 Lbs	Span/360 Lbs
24	770	0.09	770	770	580
36	510	0.20	510	390	260
48	380	0.35	290	220	150
60	310	0.56	190	140	90
72	260	0.80	130	100	60
84	220	1.08	90	70	50
96	190	1.39	70	50	40
108	170	1.78	60	40	30
120	150	2.15	50	30	20
144	130	3.22	30	20	20

## P4401 - BEAM LOADING

Span In	Max Allowable Uniform Load Lbs	Defl. at Uniform Load In	Uniform Loading at Deflection		
			Span/180 Lbs	Span/240 Lbs	Span/360 Lbs
24	2,140*	0.05	2,140*	2,140*	2,140*
36	1,420	0.11	1,420	1,420	1,240
48	1,070	0.20	1,070	1,040	700
60	850	0.32	850	670	450
72	710	0.46	620	460	310
84	610	0.63	450	340	230
96	530	0.81	350	260	170
108	470	1.03	280	210	140
120	430	1.29	220	170	110
144	360	1.86	150	120	80
168	310	2.54	110	90	60
192	270	3.31	90	70	NR
216	240	4.19	70	NR	NR
240	210	5.03	60	NR	NR

## P4400 - COLUMN LOADING

Unbraced Height In	Maximum Allowable Load at Slot Face Lbs	Maximum Column Load Applied at C.G.			
		K = 0.65 Lbs	K = 0.80 Lbs	K = 1.0 Lbs	K = 1.2 Lbs
24	2,620	8,280	7,760	7,140	6,580
36	2,470	7,210	6,580	5,310	4,030
48	2,180	6,200	4,870	3,280	2,280
60	1,770	4,760	3,280	2,100	**
72	1,420	3,450	2,280	**	**
84	1,150	2,530	1,670	**	**
96	**	1,940	**	**	**

## P4401 - COLUMN LOADING

Unbraced Height In	Maximum Allowable Load at Slot Face Lbs	Maximum Column Load Applied at C.G.			
		K = 0.65 Lbs	K = 0.80 Lbs	K = 1.0 Lbs	K = 1.2 Lbs
24	4,720	18,310	17,840	17,300	16,760
36	4,640	17,360	16,760	15,260	13,610
48	4,470	16,280	14,720	12,460	10,170
60	4,230	14,590	12,460	9,610	6,980
72	3,930	12,750	10,170	6,980	4,840
84	3,520	10,880	7,990	5,130	3,560
96	3,070	9,050	6,130	3,920	**
108	2,690	7,340	4,840	3,100	**
120	2,360	5,940	3,920	**	**

## P4400/P4401 - ELEMENTS OF SECTION

Parameter	P4400		P4401	
Area of Section	0.424	In <sup>2</sup>	0.849	In <sup>2</sup>
Axis 1-1				
Moment of Inertia (I)	0.053	In <sup>4</sup>	0.255	In <sup>4</sup>
Section Modulus (S)	0.092	In <sup>3</sup>	0.255	In <sup>3</sup>
Radius of Gyration (r)	0.354	In	0.548	In
Axis 2-2				
Moment of Inertia (I)	0.161	In <sup>4</sup>	0.322	In <sup>4</sup>
Section Modulus (S)	0.198	In <sup>3</sup>	0.396	In <sup>3</sup>
Radius of Gyration (r)	0.616	In	0.616	In

### Notes:

\* Load limited by spot weld shear.

\*\* KL/r > 200

NR = Not Recommended.

- Beam loads are given in total uniform load (W Lbs) not uniform load (w lbs/ft or w lbs/in).
- Beam loads are based on a simple span and assumed to be adequately laterally braced. Unbraced spans can reduce beam load carrying capacity. Refer to Page 62 for reduction factors for unbraced lengths.
- For pierced channel, multiply beam loads by the following factor:  
 "KO" Series .....95%                      "T" Series .....85%  
 "HS" Series .....90%                      "SL" Series .....85%  
 "WT" Series .....85%
- Deduct channel weight from the beam loads.
- For concentrated midspan point loads, multiply beam loads by 50% and the corresponding deflection by 80%. For other load conditions refer to page 18.
- All beam loads are for bending about Axis 1-1.



**P4400 - BEAM LOADING (METRIC)**

Span mm	Max Allowable Uniform Load kN	Defl. at Uniform Load mm	Uniform Loading at Deflection		
			Span/180 kN	Span/240 kN	Span/360 kN
600	3.5	2.2	3.5	3.5	2.7
750	2.8	3.4	2.8	2.6	1.7
1000	2.1	6.0	2.0	1.5	1.0
1250	1.7	9.3	1.3	1.0	0.6
1500	1.4	13.4	0.9	0.6	0.5
1750	1.2	18.6	0.6	0.5	0.3
2000	1.0	23.6	0.5	0.4	0.2
2500	0.9	38.1	0.3	0.2	0.1
3000	0.7	55.5	0.2	0.2	0.1
3500	0.6	71.6	0.2	0.1	0.1

**P4401 - BEAM LOADING (METRIC)**

Span mm	Max Allowable Uniform Load kN	Defl. at Uniform Load mm	Uniform Loading at Deflection		
			Span/180 kN	Span/240 kN	Span/360 kN
600	9.7	1.2	9.7	9.7	9.7
750	7.9	2.0	7.9	7.9	7.9
1000	5.9	3.5	5.9	5.9	4.7
1250	4.7	5.5	4.7	4.5	3.0
1500	3.9	7.9	3.9	3.1	2.1
1750	3.4	10.6	3.1	2.3	1.5
2000	2.9	14.0	2.4	1.8	1.2
2500	2.4	21.8	1.5	1.1	0.8
3000	2.0	31.2	1.0	0.8	0.5
3500	1.7	42.6	0.8	0.6	0.4
4000	1.5	56.7	0.6	0.5	0.3
4500	1.3	70.9	0.5	0.4	0.2
5000	1.2	87.2	0.4	0.3	NR
6000	1.0	127.5	0.3	NR	NR

**P4400 - COLUMN LOADING (METRIC)**

Unbraced Height mm	Maximum Allowable Load at Slot Face kN	Maximum Column Load Applied at C.G.			
		K = 0.65 kN	K = 0.80 kN	K = 1.0 kN	K = 1.2 kN
600	11.9	37.7	35.4	32.6	30.1
750	11.6	35.2	32.6	29.5	24.5
1000	10.9	31.5	27.9	21.3	15.3
1250	9.7	27.4	21.3	14.2	9.8
1500	8.2	22.1	15.3	9.8	**
1750	6.8	17.1	11.3	7.2	**
2000	5.7	13.1	8.6	**	**
2500	**	8.4	**	**	**

**P4401 - COLUMN LOADING (METRIC)**

Unbraced Height mm	Maximum Allowable Load at Slot Face kN	Maximum Column Load Applied at C.G.			
		K = 0.65 kN	K = 0.80 kN	K = 1.0 kN	K = 1.2 kN
600	21.4	83.2	81.1	78.7	76.4
750	21.2	81.0	78.7	75.4	69.8
1000	20.9	77.7	73.6	65.8	57.3
1250	20.2	73.1	65.8	55.2	44.5
1500	19.3	66.8	57.3	44.5	32.7
1750	18.2	60.0	48.8	34.6	24.0
2000	16.8	53.1	40.5	26.4	18.4
2500	13.6	39.5	26.4	16.9	**
3000	10.9	27.9	18.4	**	**

**P4400/P4401 - ELEMENTS OF SECTION (METRIC)**

Parameter	P4100	P4101
Area of Section	2.74 cm <sup>2</sup>	5.48 cm <sup>2</sup>
Axis 1-1		
Moment of Inertia (I)	2.21 cm <sup>4</sup>	10.61 cm <sup>4</sup>
Section Modulus (S)	1.51 cm <sup>3</sup>	4.18 cm <sup>3</sup>
Radius of Gyration (r)	0.90 cm	1.39 cm
Axis 2-2		
Moment of Inertia (I)	6.70 cm <sup>4</sup>	13.40 cm <sup>4</sup>
Section Modulus (S)	3.24 cm <sup>3</sup>	6.49 cm <sup>3</sup>
Radius of Gyration (r)	1.57 cm	1.57 cm

Notes:

\* Load limited by spot weld shear.

\*\* KL/r > 200

NR = Not Recommended.

- Beam loads are given in total uniform load (WLbs) not uniform load (w lbs/ft or w lbs/in).
- Beam loads are based on a simple span and assumed to be adequately laterally braced. Unbraced spans can reduce beam load carrying capacity. Refer to Page 62 for reduction factors for unbraced lengths.
- For pierced channel, multiply beam loads by the following factor:  
"KO" Series ..... 95%                      "T" Series ..... 85%  
"HS" Series ..... 90%                      "SL" Series ..... 85%  
"WT" Series ..... 85%
- Deduct channel weight from the beam loads.
- For concentrated midspan point loads, multiply beam loads by 50% and the corresponding deflection by 80%. For other load conditions refer to page 18.
- All beam loads are for bending about Axis 1-1.

**P4520 & P4521 Channels**

**P4520**

**GR PG**

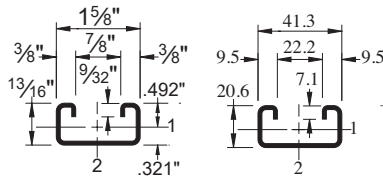
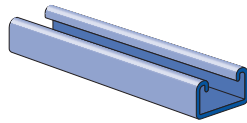

Wt/100 Ft: 131 Lbs (190 kg/100 m)  
Allowable Moment 1,615 In-Lbs (183 N·m)  
12 Gauge Nominal Thickness .105" (2.7mm)

**P4521**

**GR PG**

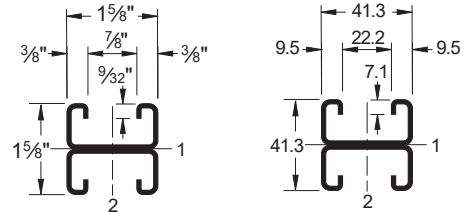
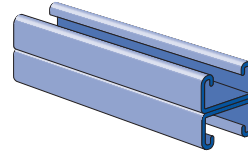

Wt/100 Ft: 262 Lbs (390 kg/100 m)  
Allowable Moment 4,540 In-Lbs (513 N·m)  
12 Gauge Nominal Thickness .105" (2.7mm)

**P4520 HS**

**GR PG**

5/16" (14.3) Dia. Holes  
1 7/8" (47.6) on Center

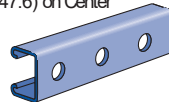

Wt/100 Ft: 120 Lbs (177 kg/100 m)

**P4520 T**

**GR PG**

Slots are  
1 1/8" (28.6) x 9/16" (14.3)  
2" (50.8) on Center

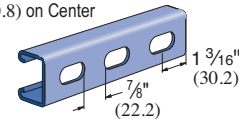

Wt/100 Ft: 120 Lbs (177 kg/100 m)

**P4520 SL**

**GR PG**

Slots are  
3" (76.2) x 1 3/32" (10.3)  
4" (101.6) on Center

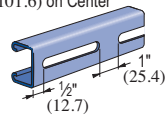

Wt/100 Ft: 118 Lbs (175 kg/100 m)

**P4520 WT**

**DF GR HG PG PL**

Slots are  
2" (50.8) x 1 1/16" (17.5)  
3" (76.2) on Center

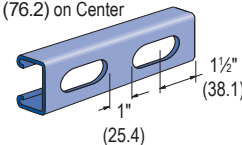

Wt/100 Ft: 120 Lbs (177 kg/100 m)

**CHANNEL NUTS (REFER TO PAGES 73,74 FOR DETAILS)**

**SEE PAGE 73, 74**



P4006-0832  
P4006-1024  
P4006-1420  
P4007  
P4008  
P4009  
P4010



P4010T



P4012  
P4023



P3006-0832  
P3006-1024  
P3006-1420  
P3007  
P3008  
P3009  
P3013



P3016-0632  
P3016-0832  
P3016-1024  
P3016-1420

Channel Finishes: PL, GR, HG, PG, ZD; Standard Lengths: 10' & 20'



1 1/8" Channel

Telestrut

Nuts & Hardware

General Fittings

Pipe/Conduit Supports

Electrical Fittings

Concrete Inserts

Solar

Unipier®

**P4520 - BEAM LOADING**

Span In	Max Allowable Uniform Load Lbs	Defl. at Uniform Load In	Uniform Loading at Deflection		
			Span/180 Lbs	Span/240 Lbs	Span/360 Lbs
24	540	0.11	540	510	340
36	360	0.24	300	220	150
48	270	0.43	170	130	80
60	220	0.68	110	80	50
72	180	0.96	70	60	40
84	150	1.27	60	40	30
96	130	1.65	40	30	20
108	120	2.16	30	20	20
120	110	2.72	30	20	NR
144	90	3.84	20	NR	NR

**P4521 - BEAM LOADING**

Span In	Max Allowable Uniform Load Lbs	Defl. at Uniform Load In	Uniform Loading at Deflection		
			Span/180 Lbs	Span/240 Lbs	Span/360 Lbs
24	1,510	0.06	1,510	1,510	1,510
36	1,010	0.14	1,010	1,010	710
48	760	0.25	760	600	400
60	610	0.40	510	380	260
72	500	0.56	360	270	180
84	430	0.77	260	200	130
96	380	1.01	200	150	100
108	340	1.29	160	120	80
120	300	1.56	130	100	60
144	250	2.25	90	70	40
168	220	3.14	70	50	NR
192	190	4.05	50	NR	NR
216	170	5.16	NR	NR	NR
240	150	6.24	NR	NR	NR

**P4520 - COLUMN LOADING**

Unbraced Height In	Maximum Allowable Load at Slot Face Lbs	Maximum Column Load Applied at C.G.			
		K = 0.65 Lbs	K = 0.80 Lbs	K = 1.0 Lbs	K = 1.2 Lbs
24	2,250	7,480	6,800	5,820	4,810
36	1,980	5,950	4,810	3,380	2,350
48	1,580	4,310	2,970	1,900	**
60	1,210	2,880	1,900	**	**
72	950	2,000	**	**	**

**P4521 - COLUMN LOADING**

Unbraced Height In	Maximum Allowable Load at Slot Face Lbs	Maximum Column Load Applied at C.G.			
		K = 0.65 Lbs	K = 0.80 Lbs	K = 1.0 Lbs	K = 1.2 Lbs
24	4,140	16,490	15,980	14,970	13,810
36	3,980	15,100	13,810	11,910	9,940
48	3,730	13,190	11,260	8,650	6,270
60	3,390	11,090	8,650	5,780	4,010
72	2,950	8,970	6,270	4,010	2,790
84	2,510	6,980	4,610	2,950	**
96	2,130	5,340	3,530	**	**
108	1,820	4,220	2,790	**	**
120	**	3,420	**	**	**

**P4520/P4521 - ELEMENTS OF SECTION**

Parameter	P4400		P4401	
Area of Section	0.384	In <sup>2</sup>	0.770	In <sup>2</sup>
Axis 1-1				
Moment of Inertia (I)	0.031	In <sup>4</sup>	0.146	In <sup>4</sup>
Section Modulus (S)	0.064	In <sup>3</sup>	0.180	In <sup>3</sup>
Radius of Gyration (r)	0.283	In	0.436	In
Axis 2-2				
Moment of Inertia (I)	0.138	In <sup>4</sup>	0.277	In <sup>4</sup>
Section Modulus (S)	0.170	In <sup>3</sup>	0.340	In <sup>3</sup>
Radius of Gyration (r)	0.599	In	0.599	In

Notes:

\* Load limited by spot weld shear.

\*\* KL/r > 200

NR = Not Recommended.

- Beam loads are given in total uniform load (WLbs) not uniform load (w lbs/ft or w lbs/in).
- Beam loads are based on a simple span and assumed to be adequately laterally braced. Unbraced spans can reduce beam load carrying capacity. Refer to Page 62 for reduction factors for unbraced lengths.
- For pierced channel, multiply beam loads by the following factor:  
 "KO" Series ..... 95%                      "T" Series ..... 85%  
 "HS" Series ..... 90%                      "SL" Series ..... 85%  
 "WT" Series ..... 85%
- Deduct channel weight from the beam loads.
- For concentrated midspan point loads, multiply beam loads by 50% and the corresponding deflection by 80%. For other load conditions refer to page 18.
- All beam loads are for bending about Axis 1-1.

# P4520 & P4521 Channels

## P4520 - BEAM LOADING (METRIC)

Span mm	Max Allowable Uniform Load kN	Defl. at Uniform Load mm	Uniform Loading at Deflection		
			Span/180 kN	Span/240 kN	Span/360 kN
600	2.5	2.6	2.5	2.4	1.6
750	2.0	4.1	2.0	1.5	1.0
1000	1.5	7.3	1.1	0.9	0.6
1250	1.2	11.3	0.7	0.5	0.4
1500	1.0	16.5	0.5	0.4	0.3
1750	0.9	22.6	0.4	0.3	0.2
2000	0.7	28.4	0.3	0.2	0.1
2500	0.6	45.0	0.2	0.1	0.1
3000	0.5	65.8	0.1	0.1	NR
3500	0.4	85.5	0.1	0.1	NR

## P4521 - BEAM LOADING (METRIC)

Span mm	Max Allowable Uniform Load kN	Defl. at Uniform Load mm	Uniform Loading at Deflection		
			Span/180 kN	Span/240 kN	Span/360 kN
600	7.0	1.6	7.0	7.0	7.0
750	5.6	2.4	5.6	5.6	4.8
1000	4.2	4.3	4.2	4.0	2.7
1250	3.4	6.7	3.4	2.6	1.7
1500	2.8	9.6	2.4	1.8	1.2
1750	2.4	13.3	1.8	1.3	0.9
2000	2.1	17.2	1.4	1.0	0.7
2500	1.7	27.0	0.9	0.6	0.5
3000	1.4	39.1	0.6	0.5	0.3
3500	1.2	52.0	0.5	0.3	0.2
4000	1.0	68.7	0.3	0.3	0.2
4500	0.9	85.1	0.3	0.2	NR
5000	0.8	105.0	0.2	NR	NR
6000	0.7	151.2	NR	NR	NR

## P4520 - COLUMN LOADING (METRIC)

Unbraced Height mm	Maximum Allowable Load at Slot Face kN	Maximum Column Load Applied at C.G.			
		K = 0.65 kN	K = 0.80 kN	K = 1.0 kN	K = 1.2 kN
600	10.3	34.1	31.1	26.8	22.2
750	9.7	30.9	26.8	21.1	15.8
1000	8.5	24.9	19.3	12.8	8.9
1250	6.9	18.9	12.8	8.2	**
1500	5.6	13.5	8.9	**	**
1750	4.6	9.9	6.5	**	**

## P4521 - COLUMN LOADING (METRIC)

Unbraced Height mm	Maximum Allowable Load at Slot Face kN	Maximum Column Load Applied at C.G.			
		K = 0.65 kN	K = 0.80 kN	K = 1.0 kN	K = 1.2 kN
600	18.8	74.9	72.8	68.3	63.1
750	18.5	72.5	68.3	61.8	54.7
1000	17.8	66.2	59.5	49.8	40.1
1250	16.8	58.9	49.8	37.8	27.0
1500	15.5	51.1	40.1	27.0	18.8
1750	14.0	43.1	31.1	19.9	13.8
2000	12.2	35.5	23.8	15.2	**
2500	9.3	23.0	15.2	**	**
3000	**	16.0	**	**	**

## P4520/P4521 - ELEMENTS OF SECTION (METRIC)

Parameter	P4100	P4101
Area of Section	2.48 cm <sup>2</sup>	4.97 cm <sup>2</sup>
Axis 1-1		
Moment of Inertia (I)	1.29 cm <sup>4</sup>	6.08 cm <sup>4</sup>
Section Modulus (S)	1.05 cm <sup>3</sup>	2.95 cm <sup>3</sup>
Radius of Gyration (r)	0.72 cm	1.11 cm
Axis 2-2		
Moment of Inertia (I)	5.74 cm <sup>4</sup>	11.53 cm <sup>4</sup>
Section Modulus (S)	2.79 cm <sup>3</sup>	5.57 cm <sup>3</sup>
Radius of Gyration (r)	1.52 cm	1.53 cm

Notes:

\* Load limited by spot weld shear.

\*\* KL/r > 200

NR = Not Recommended.

- Beam loads are given in total uniform load (W Lbs) not uniform load (w lbs/ft or w lbs/in).
- Beam loads are based on a simple span and assumed to be adequately laterally braced. Unbraced spans can reduce beam load carrying capacity. Refer to Page 62 for reduction factors for unbraced lengths.
- For pierced channel, multiply beam loads by the following factor:  
 "KO" Series .....95%                      "T" Series .....85%  
 "HS" Series .....90%                      "SL" Series .....85%  
 "WT" Series .....85%
- Deduct channel weight from the beam loads.
- For concentrated midspan point loads, multiply beam loads by 50% and the corresponding deflection by 80%. For other load conditions refer to page 18.
- All beam loads are for bending about Axis 1-1.

1 1/8" Channel  
 Telestrut  
 Nuts & Hardware  
 General Fittings  
 Pipe/Conduit Supports  
 Electrical Fittings  
 Concrete Inserts  
 Solar  
 Unipier®



1 5/8" Channel

Telestrut

Nuts & Hardware

General Fittings

Pipe/Conduit Supports

Electrical Fittings

Concrete Inserts

Solar

Unipier®

**P5000**

DF GR PL PG

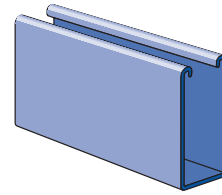
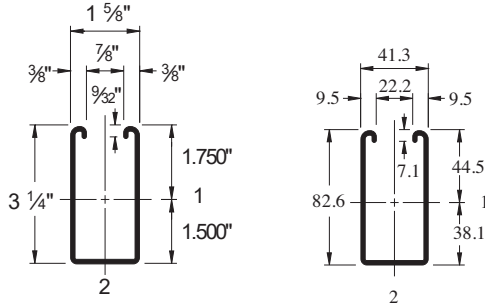

W/100 Ft: 305 Lbs (454 kg/100 m)  
Allowable Moment 15,770 In-Lbs (1,780 N·m)  
12 Gauge Nominal Thickness .105" (2.7mm)

**P5001**

DF GR PG

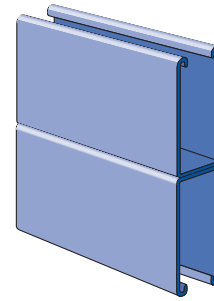
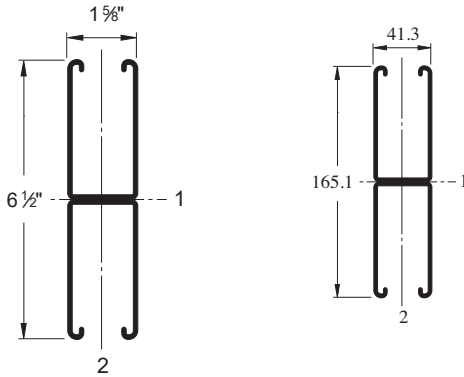

W/100 Ft: 610 Lbs (907 kg/100 m)  
Allowable Moment 48,180 In-Lbs (5,440 N·m)  
12 Gauge Nominal Thickness .105" (2.7mm)

**P5000 HS**

GR PG

**P5000 KO**

GR PG

9/16" (14.3) Dia. Holes  
1 1/8" (47.6) on Center

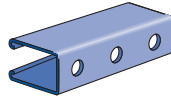

W/100 Ft: 300 Lbs (446 kg/100 m)

7/8" (22.2) Knockouts  
6" (152.4) on Center

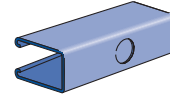

W/100 Ft: 305 Lbs (454 kg/100 m)

**P5000 SL**

GR PG

**P5000 T**

DF GR PG

**P5000 WT**

DF GR HG PG PL

Slots are  
3" (76.2) x 1 1/2" (10.3)  
4" (101.6) on Center

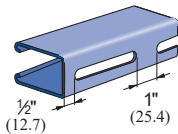

W/100 Ft: 300 Lbs (446 kg/100 m)

Slots are  
1 1/8" (28.6) x 9/16" (14.3)  
2" (50.8) on Center

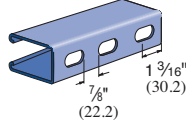

W/100 Ft: 300 Lbs (446 kg/100 m)

Slots are  
2" (50.8) x 1 1/16" (17.5)  
3" (76.2) on Center

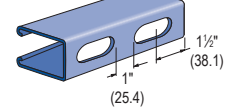

W/100 Ft: 300 Lbs (446 kg/100 m)

**CHANNEL NUTS** (REFER TO PAGES 73,74 FOR DETAILS)

SEE PAGE 73, 74

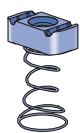

P5506-0832  
P5506-1024  
P5506-1420  
P5507  
P5508  
P5509  
P5510



P1006T1420  
P1008T  
P1010T



P1012  
P1023  
P1024



P3006-0832  
P3006-1024  
P3006-1420  
P3007  
P3008  
P3009  
P3010



P3016-0632  
P3016-0832  
P3016-1024  
P3016-1420

Channel Finishes: DF, PL, GR, HG, PG, ZD; Standard Lengths: 10' & 20'

# P5000 & P5001 Channels

## P5000 - BEAM LOADING

Span In	Max Allowable Uniform Load Lbs	Defl. at Uniform Load In	Uniform Loading at Deflection		
			Span/180 Lbs	Span/240 Lbs	Span/360 Lbs
24	5,260	0.03	5,260	5,260	5,260
36	3,500	0.07	3,500	3,500	3,500
48	2,630	0.12	2,630	2,630	2,630
60	2,100	0.18	2,100	2,100	1,920
72	1,750	0.26	1,750	1,750	1,330
84	1,500	0.36	1,500	1,470	980
96	1,310	0.47	1,310	1,120	750
108	1,170	0.59	1,170	890	590
120	1,050	0.73	960	720	480
144	880	1.06	670	500	330
168	750	1.43	490	370	240
192	660	1.88	370	280	190
216	580	2.35	300	220	150
240	530	2.95	240	180	120

## P5001 - BEAM LOADING

Span In	Max Allowable Uniform Load Lbs	Defl. at Uniform Load In	Uniform Loading at Deflection		
			Span/180 Lbs	Span/240 Lbs	Span/360 Lbs
24	6,890*	0.01	6,890*	6,890*	6,890*
36	6,890*	0.02	6,890*	6,890*	6,890*
48	6,890*	0.05	6,890*	6,890*	6,890*
60	6,420	0.10	6,420	6,420	6,420
72	5,350	0.14	5,350	5,350	5,350
84	4,590	0.19	4,590	4,590	4,590
96	4,020	0.25	4,020	4,020	4,020
108	3,570	0.32	3,570	3,570	3,360
120	3,210	0.39	3,210	3,210	2,720
144	2,680	0.57	2,680	2,680	1,890
168	2,290	0.77	2,290	2,080	1,390
192	2,010	1.01	2,010	1,590	1,060
216	1,780	1.27	1,680	1,260	840
240	1,610	1.58	1,360	1,020	680

## P5000 - COLUMN LOADING

Unbraced Height In	Maximum Allowable Load at Slot Face Lbs	Maximum Column Load Applied at C.G.			
		K = 0.65 Lbs	K = 0.80 Lbs	K = 1.0 Lbs	K = 1.2 Lbs
24	5,650	16,870	15,180	12,850	10,600
36	4,690	13,140	10,600	7,650	5,660
48	3,560	9,550	6,860	4,790	3,660
60	2,730	6,680	4,790	3,450	2,710
72	2,160	4,980	3,660	2,710	2,170
84	1,760	3,950	2,960	2,240	1,820
96	1,500	3,270	2,500	1,930	1,580
108	1,310	2,800	2,170	1,690	1,390
120	1,170	2,450	1,930	1,510	**
144	980	1,980	1,580	**	**
168	850	1,670	1,340	**	**

## P5001 - COLUMN LOADING

Unbraced Height In	Maximum Allowable Load at Slot Face Lbs	Maximum Column Load Applied at C.G.			
		K = 0.65 Lbs	K = 0.80 Lbs	K = 1.0 Lbs	K = 1.2 Lbs
24	10,670	39,230	38,030	36,210	34,240
36	10,350	36,450	34,240	31,200	28,260
48	9,940	33,220	30,200	26,430	23,190
60	9,290	29,950	26,430	22,470	19,380
72	8,560	26,880	23,190	19,380	16,450
84	7,860	24,140	20,520	17,040	12,090
96	7,220	21,790	18,370	13,330	9,250
108	6,600	19,790	16,450	10,530	7,310
120	5,760	18,130	13,330	8,530	**
144	4,390	14,020	9,250	**	**
168	3,420	10,300	6,800	**	**

## P5000/P5001 - ELEMENTS OF SECTION

Parameter	P5000		P5001	
Area of Section	0.897	In <sup>2</sup>	1.793	In <sup>2</sup>
Axis 1-1				
Moment of Inertia (I)	1.098	In <sup>4</sup>	6.227	In <sup>4</sup>
Section Modulus (S)	0.627	In <sup>3</sup>	1.916	In <sup>3</sup>
Radius of Gyration (r)	1.107	In	1.864	In
Axis 2-2				
Moment of Inertia (I)	0.433	In <sup>4</sup>	0.866	In <sup>4</sup>
Section Modulus (S)	0.533	In <sup>3</sup>	1.066	In <sup>3</sup>
Radius of Gyration (r)	0.695	In	0.695	In

Notes:

\* Load limited by spot weld shear.

\*\* KL/r > 200

NR = Not Recommended.

- Beam loads are given in total uniform load (W Lbs) not uniform load (w lbs/ft or w lbs/in).
- Beam loads are based on a simple span and assumed to be adequately laterally braced. Unbraced spans can reduce beam load carrying capacity. Refer to Page 62 for reduction factors for unbraced lengths.
- For pierced channel, multiply beam loads by the following factor:  
 "KO" Series ..... 95%                      "T" Series ..... 85%  
 "HS" Series ..... 90%                      "SL" Series ..... 85%  
 "WT" Series ..... 85%
- Deduct channel weight from the beam loads.
- For concentrated midspan point loads, multiply beam loads by 50% and the corresponding deflection by 80%. For other load conditions refer to page 18.
- All beam loads are for bending about Axis 1-1.



1 1/8" Channel

Telestrut

Nuts & Hardware

General Fittings

Pipe/Conduit Supports

Electrical Fittings

Concrete Inserts

Solar

Unipier®

**P5000 - BEAM LOADING (METRIC)**

Span mm	Max Allowable Uniform Load kN	Defl. at Uniform Load mm	Uniform Loading at Deflection		
			Span/180 kN	Span/240 kN	Span/360 kN
600	23.8	1	23.8	23.8	23.8
750	19.0	1	19.0	19.0	19.0
1,000	14.2	2	14.2	14.2	14.2
1,250	11.4	3	11.4	11.4	11.4
1,500	9.5	5	9.5	9.5	8.8
1,750	8.1	6	8.1	8.1	6.5
2,000	7.1	8	7.1	7.1	4.9
2,500	5.7	12	5.7	4.8	3.2
3,000	4.8	18	4.4	3.3	2.2
3,500	4.1	25	3.2	2.4	1.6
4,000	3.6	32	2.5	1.9	1.2
4,500	3.2	40	2.0	1.5	1.0
5,000	2.8	50	1.6	1.2	0.8
6,000	2.4	71	1.1	0.8	0.5

**P5001 - BEAM LOADING (METRIC)**

Span mm	Max Allowable Uniform Load kN	Defl. at Uniform Load mm	Uniform Loading at Deflection		
			Span/180 kN	Span/240 kN	Span/360 kN
600	30.6 *	0	30.6 *	30.6 *	30.6 *
750	30.6 *	0	30.6 *	30.6 *	30.6 *
1,000	30.6 *	1	30.6 *	30.6 *	30.6 *
1,250	30.6 *	1	30.6 *	30.6 *	30.6 *
1,500	29.0	2	29.0	29.0	29.0
1,750	24.9	3	24.9	24.9	24.9
2,000	21.8	4	21.8	21.8	21.8
2,500	17.4	7	17.4	17.4	17.4
3,000	14.5	10	14.5	14.5	12.5
3,500	12.5	13	12.5	12.5	9.2
4,000	10.9	17	10.9	10.5	7.0
4,500	9.7	22	9.7	8.3	5.6
5,000	8.7	27	8.7	6.8	4.5
6,000	7.2	39	6.2	4.7	3.1

**P5000 - COLUMN LOADING (METRIC)**

Unbraced Height mm	Maximum Allowable Load at Slot Face kN	Maximum Column Load Applied at C.G.			
		K = 0.65 kN	K = 0.80 kN	K = 1.0 kN	K = 1.2 kN
600	25.2	75.5	68.1	58.0	48.0
750	23.5	67.5	58.0	45.7	35.0
1,000	19.4	53.7	41.9	29.3	21.8
1,250	15.4	41.0	29.3	20.5	15.7
1,500	12.4	30.5	21.8	15.7	12.3
1,750	10.2	23.8	17.3	12.8	10.2
2,000	8.5	19.3	14.4	10.8	8.7
2,250	7.3	16.3	12.3	9.4	7.6
2,500	6.5	14.1	10.8	8.3	6.9
2,750	5.8	12.4	9.6	7.5	6.2

**P5001 - COLUMN LOADING (METRIC)**

Unbraced Height mm	Maximum Allowable Load at Slot Face kN	Maximum Column Load Applied at C.G.			
		K = 0.65 kN	K = 0.80 kN	K = 1.0 kN	K = 1.2 kN
600	47.5	174.9	169.7	161.7	153.2
750	46.8	169.2	161.7	150.9	139.8
1,000	45.6	158.2	147.2	132.6	118.8
1,250	44.0	146.3	132.6	115.6	101.2
1,500	41.6	134.3	118.8	101.2	87.4
1,750	38.9	122.9	106.6	89.4	76.8
2,000	36.3	112.5	96.2	80.0	61.2
2,250	33.9	103.2	87.4	69.6	48.4
2,500	31.6	95.0	80.0	56.4	39.1
2,750	29.3	87.8	72.9	46.6	32.4

**P5000/P5001 - ELEMENTS OF SECTION (METRIC)**

Parameter	P5000	P5001
Area of Section	5.78 cm <sup>2</sup>	11.57 cm <sup>2</sup>
Axis 1-1		
Moment of Inertia (I)	45.70 cm <sup>4</sup>	259.17 cm <sup>4</sup>
Section Modulus (S)	10.28 cm <sup>3</sup>	31.40 cm <sup>3</sup>
Radius of Gyration (r)	2.81 cm	4.73 cm
Axis 2-2		
Moment of Inertia (I)	18.02 cm <sup>4</sup>	36.04 cm <sup>4</sup>
Section Modulus (S)	8.73 cm <sup>3</sup>	17.46 cm <sup>3</sup>
Radius of Gyration (r)	1.77 cm	1.77 cm

Notes:

\* Load limited by spot weld shear.

\*\* KL/r > 200

NR = Not Recommended.

- Beam loads are given in total uniform load (WLbs) not uniform load (w lbs/ft or w lbs/in).
- Beam loads are based on a simple span and assumed to be adequately laterally braced. Unbraced spans can reduce beam load carrying capacity. Refer to Page 62 for reduction factors for unbraced lengths.
- For pierced channel, multiply beam loads by the following factor:  
 "KO" Series ..... 95%                      "T" Series ..... 85%  
 "HS" Series ..... 90%                      "SL" Series ..... 85%  
 "WT" Series ..... 85%
- Deduct channel weight from the beam loads.
- For concentrated midspan point loads, multiply beam loads by 50% and the corresponding deflection by 80%. For other load conditions refer to page 18.
- All beam loads are for bending about Axis 1-1.



**P5500 & P5501 Channels**

**P5500**

**GR PG**

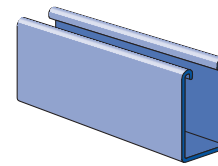
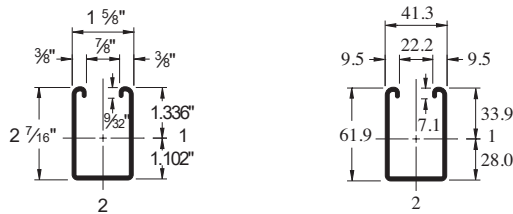

W/100 Ft: 247 Lbs (367 kg/100 m)  
Allowable Moment 9,820 In-Lbs (1,110 N·m)  
12 Gauge Nominal Thickness .105" (2.7mm)

**P5501**

**GR PG**

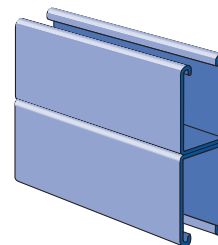
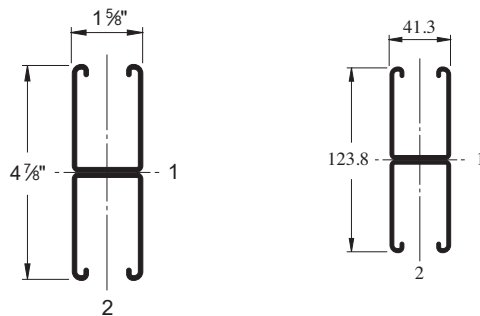

W/100 Ft: 494 Lbs (734 kg/100 m)  
Allowable Moment 28,940 In-Lbs (3,270 N·m)  
12 Gauge Nominal Thickness .105" (2.7mm)

**P5500 HS**

**GR PG**

**P5500 KO**

**GR PG**

**P5500 SL**

**GR PG**

9/16" (14.3) Dia. Holes  
1 7/8" (47.6) on Center

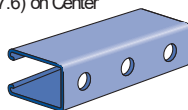

W/100 Ft: 242 Lbs (360 kg/100 m)

7/8" (22.2) Knockouts  
6" (152.4) on Center

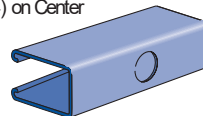

W/100 Ft: 247 Lbs (368 kg/100 m)

Slots are  
3" (76.2) x 13/32" (10.3)  
4" (101.6) on Center

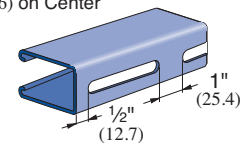

W/100 Ft: 242 Lbs (360 kg/100 m)

**P5500 T**

**GR PG**

**P5500 WT**

**DF GR HG PG PL**

Slots are  
1 1/8" (28.6) x 9/16" (14.3)  
2" (50.8) on Center

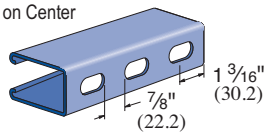

W/100 Ft: 242 Lbs (360 kg/100 m)

Slots are  
2" (50.8) x 1 1/16" (17.5)  
3" (76.2) on Center

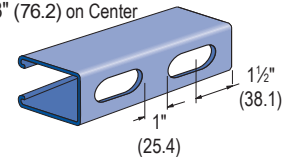

W/100 Ft: 242 Lbs (360 kg/100 m)

**CHANNEL NUTS** (REFER TO PAGES 73,74 FOR DETAILS)

**SEE PAGE 73, 74**

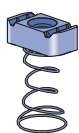

P5506-0832  
P5506-1024  
P5506-1420  
P5507  
P5508  
P5509  
P5510



P1006T1420  
P1008T  
P1010T



P1012  
P1023  
P1024



P3006-0832  
P3006-1024  
P3006-1420  
P3007  
P3008  
P3009  
P3010



P3016-0632  
P3016-0832  
P3016-1024  
P3016-1420

Channel Finishes: PL, GR, HG, PG, ZD; Standard Lengths: 10' & 20'



1 1/8" Channel

Telestrut

Nuts & Hardware

General Fittings

Pipe/Conduit Supports

Electrical Fittings

Concrete Inserts

Solar

Unipier®

**P5500 - BEAM LOADING**

Span In	Max Allowable Uniform Load Lbs	Defl. at Uniform Load In	Uniform Loading at Deflection		
			Span/180 Lbs	Span/240 Lbs	Span/360 Lbs
24	3,270	0.04	3,270	3,270	3,270
36	2,180	0.09	2,180	2,180	2,180
48	1,640	0.15	1,640	1,640	1,420
60	1,310	0.24	1,310	1,310	910
72	1,090	0.34	1,090	950	630
84	940	0.47	930	700	470
96	820	0.61	710	530	360
108	730	0.78	560	420	280
120	650	0.95	460	340	230
144	550	1.39	320	240	160
168	470	1.89	230	170	120
192	410	2.46	180	130	90
216	360	3.07	140	110	70
240	330	3.86	110	90	60

**P5501 - BEAM LOADING**

Span In	Max Allowable Uniform Load Lbs	Defl. at Uniform Load In	Uniform Loading at Deflection		
			Span/180 Lbs	Span/240 Lbs	Span/360 Lbs
24	5,220*	0.01	5,220*	5,220*	5,220*
36	5,220*	0.04	5,220*	5,220*	5,220*
48	4,820	0.08	4,820	4,820	4,820
60	3,860	0.13	3,860	3,860	3,860
72	3,220	0.19	3,220	3,220	3,220
84	2,760	0.26	2,760	2,760	2,500
96	2,410	0.34	2,410	2,410	1,920
108	2,140	0.42	2,140	2,140	1,510
120	1,930	0.52	1,930	1,840	1,230
144	1,610	0.76	1,610	1,280	850
168	1,380	1.03	1,250	940	630
192	1,210	1.35	960	720	480
216	1,070	1.70	760	570	380
240	960	2.09	610	460	310

**P5500 - COLUMN LOADING**

Unbraced Height In	Maximum Allowable Load at Slot Face Lbs	Maximum Column Load Applied at C.G.			
		K = 0.65 Lbs	K = 0.80 Lbs	K = 1.0 Lbs	K = 1.2 Lbs
24	4,640	13,840	12,570	10,840	9,190
36	3,970	11,050	9,190	7,030	5,370
48	3,180	8,420	6,390	4,620	3,630
60	2,550	6,250	4,620	3,450	2,780
72	2,120	4,790	3,630	2,780	2,260
84	1,810	3,890	3,010	2,330	1,910
96	1,580	3,290	2,580	2,020	1,650
108	1,400	2,860	2,260	1,770	1,440
120	1,270	2,530	2,020	1,580	**
144	1,060	2,070	1,650	**	**
168	920	1,750	1,380	**	**

**P5501 - COLUMN LOADING**

Unbraced Height In	Maximum Allowable Load at Slot Face Lbs	Maximum Column Load Applied at C.G.			
		K = 0.65 Lbs	K = 0.80 Lbs	K = 1.0 Lbs	K = 1.2 Lbs
24	8,580	31,810	30,880	29,520	28,100
36	8,350	29,700	28,100	26,000	24,070
48	8,080	27,390	25,330	22,910	20,940
60	7,720	25,170	22,910	20,510	17,170
72	7,270	23,190	20,940	17,170	12,700
84	6,780	21,510	18,740	13,430	9,330
96	6,130	20,110	15,630	10,290	7,150
108	5,450	17,750	12,700	8,130	5,650
120	4,800	15,260	10,290	6,590	**
144	3,760	10,830	7,150	**	**
168	2,970	7,950	5,250	**	**

**P5500/P5501 - ELEMENTS OF SECTION**

Parameter	P5500		P5501	
Area of Section	0.726	In <sup>2</sup>	1.452	In <sup>2</sup>
Axis 1-1				
Moment of Inertia (I)	0.522	In <sup>4</sup>	2.805	In <sup>4</sup>
Section Modulus (S)	0.390	In <sup>3</sup>	1.151	In <sup>3</sup>
Radius of Gyration (r)	0.848	In	1.390	In
Axis 2-2				
Moment of Inertia (I)	0.334	In <sup>4</sup>	0.669	In <sup>4</sup>
Section Modulus (S)	0.411	In <sup>3</sup>	0.823	In <sup>3</sup>
Radius of Gyration (r)	0.679	In	0.679	In

Notes:

\* Load limited by spot weld shear.

\*\* KL/r > 200

NR = Not Recommended.

- Beam loads are given in total uniform load (WLbs) not uniform load (w lbs/ft or w lbs/in).
- Beam loads are based on a simple span and assumed to be adequately laterally braced. Unbraced spans can reduce beam load carrying capacity. Refer to Page 62 for reduction factors for unbraced lengths.
- For pierced channel, multiply beam loads by the following factor:  
 "KO" Series ..... 95%                      "T" Series ..... 85%  
 "HS" Series ..... 90%                      "SL" Series ..... 85%  
 "WT" Series ..... 85%
- Deduct channel weight from the beam loads.
- For concentrated midspan point loads, multiply beam loads by 50% and the corresponding deflection by 80%. For other load conditions refer to page 18.
- All beam loads are for bending about Axis 1-1.

# P5500 & P5501 Channels

## P5500 - BEAM LOADING (METRIC)

Span mm	Max Allowable Uniform Load kN	Defl. at Uniform Load mm	Uniform Loading at Deflection		
			Span/180 kN	Span/240 kN	Span/360 kN
600	14.8	1	14.8	14.8	14.8
750	11.8	1	11.8	11.8	11.8
1,000	8.9	3	8.9	8.9	8.9
1,250	7.1	4	7.1	7.1	6.1
1,500	5.9	6	5.9	5.9	4.2
1,750	5.1	8	5.1	4.6	3.1
2,000	4.5	10	4.5	3.5	2.4
2,500	3.6	16	3.0	2.3	1.5
3,000	3.0	24	2.1	1.6	1.1
3,500	2.5	32	1.6	1.2	0.8
4,000	2.2	42	1.2	0.9	0.6
4,500	2.0	53	0.9	0.7	0.4
5,000	1.8	66	0.8	0.6	0.4
6,000	1.5	94	0.5	0.4	0.3

## P5501 - BEAM LOADING (METRIC)

Span mm	Max Allowable Uniform Load kN	Defl. at Uniform Load mm	Uniform Loading at Deflection		
			Span/180 kN	Span/240 kN	Span/360 kN
600	23.2 *	0	23.2 *	23.2 *	23.2 *
750	23.2 *	1	23.2 *	23.2 *	23.2 *
1,000	23.2 *	1	23.2 *	23.2 *	23.2 *
1,250	20.9	2	20.9	20.9	20.9
1,500	17.4	3	17.4	17.4	17.4
1,750	14.9	4	14.9	14.9	14.9
2,000	13.1	6	13.1	13.1	12.7
2,500	10.5	9	10.5	10.5	8.1
3,000	8.7	13	8.7	8.5	5.6
3,500	7.5	18	7.5	6.2	4.1
4,000	6.5	23	6.3	4.8	3.2
4,500	5.8	29	5.0	3.7	2.5
5,000	5.2	36	4.1	3.0	2.0
6,000	4.4	52	2.8	2.1	1.4

## P5500 - COLUMN LOADING (METRIC)

Unbraced Height mm	Maximum Allowable Load at Slot Face kN	Maximum Column Load Applied at C.G.			
		K = 0.65 kN	K = 0.80 kN	K = 1.0 kN	K = 1.2 kN
600	20.7	61.9	56.4	48.8	41.6
750	19.6	55.9	48.8	39.8	31.9
1,000	16.7	45.7	37.0	27.4	21.0
1,250	13.8	36.4	27.4	19.9	15.7
1,500	11.5	28.5	21.0	15.7	12.6
1,750	9.8	22.6	17.1	13.0	10.6
2,000	8.6	18.9	14.5	11.2	9.1
2,250	7.6	16.2	12.6	9.8	8.0
2,500	6.9	14.2	11.2	8.7	7.2
2,750	6.2	12.7	10.1	7.9	6.4

## P5501 - COLUMN LOADING (METRIC)

Unbraced Height mm	Maximum Allowable Load at Slot Face kN	Maximum Column Load Applied at C.G.			
		K = 0.65 kN	K = 0.80 kN	K = 1.0 kN	K = 1.2 kN
600	38.2	141.5	137.4	131.3	125.0
750	37.1	132.1	125.0	115.6	107.1
1,000	35.9	121.8	112.7	101.9	93.1
1,250	34.3	112.0	101.9	91.2	76.4
1,500	32.3	103.2	93.1	76.4	56.5
1,750	30.2	95.7	83.4	59.7	41.5
2,000	27.3	89.5	69.5	45.8	31.8
2,500	24.2	79.0	56.5	36.2	25.1
3,000	21.3	67.9	45.8	29.3	**
3,500	16.7	48.2	31.8	**	**
4,000	13.2	35.4	23.3	**	**

## P5500/P5501 - ELEMENTS OF SECTION (METRIC)

Parameter	P5500	P5501
Area of Section	4.68 cm <sup>2</sup>	9.37 cm <sup>2</sup>
Axis 1-1		
Moment of Inertia (I)	21.71 cm <sup>4</sup>	116.76 cm <sup>4</sup>
Section Modulus (S)	6.40 cm <sup>3</sup>	18.86 cm <sup>3</sup>
Radius of Gyration (r)	2.15 cm	3.53 cm
Axis 2-2		
Moment of Inertia (I)	13.91 cm <sup>4</sup>	27.83 cm <sup>4</sup>
Section Modulus (S)	6.74 cm <sup>3</sup>	13.48 cm <sup>3</sup>
Radius of Gyration (r)	1.72 cm	1.72 cm

### Notes:

\* Load limited by spot weld shear.

\*\* KL/r > 200

NR = Not Recommended.

- Beam loads are given in total uniform load (W Lbs) not uniform load (w lbs/ft or w lbs/in).
- Beam loads are based on a simple span and assumed to be adequately laterally braced. Unbraced spans can reduce beam load carrying capacity. Refer to Page 62 for reduction factors for unbraced lengths.
- For pierced channel, multiply beam loads by the following factor:  
"KO" Series .....95%                      "T" Series .....85%  
"HS" Series .....90%                      "SL" Series .....85%  
"WT" Series .....85%
- Deduct channel weight from the beam loads.
- For concentrated midspan point loads, multiply beam loads by 50% and the corresponding deflection by 80%. For other load conditions refer to page 18.
- All beam loads are for bending about Axis 1-1.



1 5/8" Channel

Telestrut

Nuts & Hardware

General Fittings

Pipe/Conduit Supports

Electrical Fittings

Concrete Inserts

Solar

Unipier®

**P1184 P**

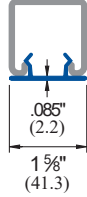
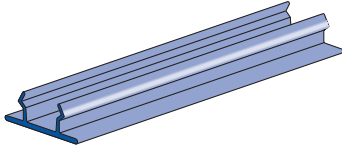

Material: Paintable PVC  
Color: Green, Grey  
Standard length: 10' (3m)

W/100 Ft: 11 Lbs (16.5 kg/100 m)

**P3184**

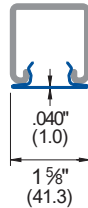
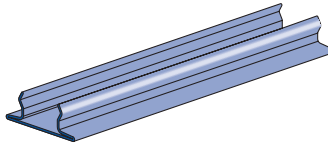

Finish: GR, PG, PL  
Standard length: 10' (3m)

W/100 Ft: 47 Lbs (69.9 kg/100 m)

**P3184 F**

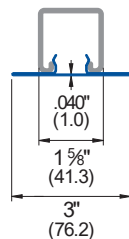
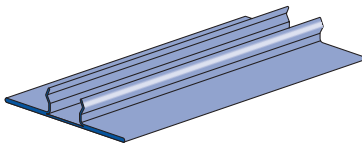

Finish: GR, PG, PL  
Standard length: 16' (4.9m)

W/100 Ft: 90 Lbs (134 kg/100 m)

**P3184 P**

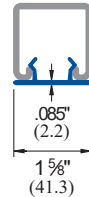
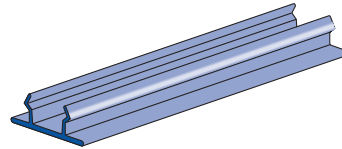

Material : G.E. Noryl® Plastic  
Color: Green, Grey and White  
Standard length: 10' (3m)

W/100 Ft: 9.4 Lbs (14.0 kg/100 m)

**P3712 P**

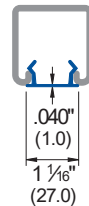
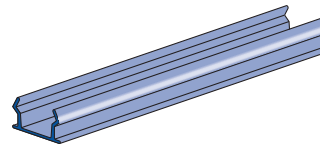

Material: Plastic  
Color: Black  
Standard length: 10' (3m)  
Note: Use with P3170, P3270, and P3370 series concrete insert.

W/100 Ft: 5.4 Lbs (8.0 kg/100 m)

**End Caps and Frame Caps**

**P1280** EG

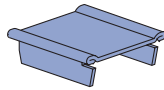

Use with P1000  
Material: .060" (1.5)

Wt/100 pcs: 11 Lbs (5.0 Kg.)

**P2407, P3280, P3380** END CAPS EG

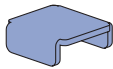

Part Number	Fits Channel	Wt/100 pcs Lbs (kg)
P2407	P1000	10 4.5
P3280	P3000	8 3.6
P3380*	P3300	5 2.3

**P1280 A, P2280 A**

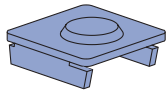

Material: .075" (1.9)

Part Number	Use With Channel	Wt/100 pcs Lbs (kg)
P1280A	P1000	11 5.0
P2280A	P2000	11 5.0

**P1180, P2280, P4280, P5280, P5580** EG

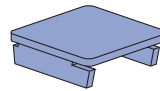

Material: .075" (1.9)

Part Number	Use With Channel	Wt/100 pcs Lbs (kg)
P1180	P1100	12 5.4
P2280	P2000	11 5.0
P4280	P4000	5 2.3
P5280	P5000	22 10.0
P5580	P5500	17 7.7

**P2859** FRAME CAPS GY WH

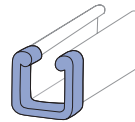

\* Add color suffix:  
GR - Green  
WH - White  
GY - Grey  
"A" series frame caps available

Part Number*	Use With Channel	Wt/100 pcs Lbs (kg)
P2859-10	P1000	12 5.4
P2859-11	P1001	12 5.4
P2859-12	P3300	5 2.3
P2859-13	P5000	22 10.0
P2859-14	P5500	17 7.7

**P2860** PLASTIC WHITE END CAPS VY

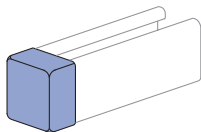

**P2860-10**

Use with P1000, P1100, P2000 channels & P9000 Telestrut.  
Wt/100 pcs 3.4 Lbs (1.5 kg)

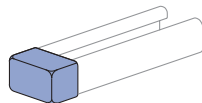

**P2860-33**

Use with P3300 channel.  
Wt/100 pcs 2.5 Lbs (1.1 kg)

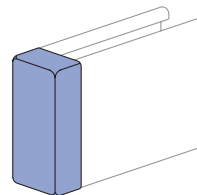

**P2860-50**

Use with P5000 & P1001 channels.  
Wt/100 pcs 5 Lbs (2.3 kg)

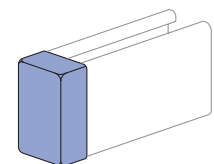

**P2860-55**

Use with P5500 channel.  
Wt/100 pcs 4.7 Lbs (2.1 kg)

1 1/8" Channel  
Telestrut  
Nuts & Hardware  
General Fittings  
Pipe/Conduit Supports  
Electrical Fittings  
Concrete Inserts  
Solar  
Unipier®



**LATERAL BRACING LOAD REDUCTION CHARTS**

Span		Single Channel											Double Channel										
Ft. (m)	In. (cm)	P1000	P1100	P2000	P3000	P3300	P4000	P4100	P4400	P4520	P5000	P5500	P1001	P1101	P2001	P3001	P3301	P4001	P4101	P4401	P4521	P5001	P5501
2 (0.61)	24 (61)	1.00	1.00	1.00	1.00	1.00	1.00	1.00	1.00	1.00	0.98	0.99	1.00	1.00	1.00	1.00	1.00	1.00	1.00	1.00	1.00	1.00	1.00
3 (0.91)	36 (91)	0.94	0.89	0.88	0.96	1.00	0.94	0.98	1.00	1.00	0.85	0.89	1.00	1.00	1.00	1.00	1.00	1.00	1.00	1.00	1.00	1.00	1.00
4 (1.22)	48 (122)	0.88	0.78	0.75	0.91	1.00	0.88	0.94	0.98	1.00	0.70	0.77	1.00	0.98	0.98	1.00	1.00	0.98	1.00	1.00	1.00	0.97	0.98
5 (1.52)	60 (152)	0.82	0.68	0.61	0.88	0.98	0.83	0.91	0.96	1.00	0.55	0.67	0.97	0.93	0.92	0.98	1.00	0.93	0.96	1.00	1.00	0.90	0.93
6 (1.83)	72 (183)	0.78	0.59	0.48	0.84	0.97	0.79	0.89	0.94	0.98	0.44	0.58	0.93	0.87	0.85	0.95	0.97	0.88	0.92	0.97	0.97	0.83	0.87
7 (2.13)	84 (213)	0.75	0.52	0.41	0.82	0.96	0.75	0.86	0.92	0.97	0.38	0.51	0.89	0.82	0.78	0.92	0.95	0.83	0.89	0.95	0.95	0.76	0.81
8 (2.44)	96 (244)	0.71	0.47	0.35	0.79	0.94	0.72	0.84	0.91	0.96	0.33	0.46	0.85	0.76	0.71	0.88	0.92	0.79	0.85	0.92	0.92	0.68	0.76
9 (2.74)	108 (274)	0.69	0.43	0.32	0.77	0.93	0.69	0.82	0.89	0.95	0.30	0.42	0.81	0.70	0.64	0.85	0.90	0.74	0.81	0.90	0.90	0.61	0.70
10 (3.05)	120 (305)	0.66	0.40	0.29	0.75	0.92	0.66	0.80	0.87	0.94	0.28	0.40	0.78	0.65	0.57	0.82	0.87	0.69	0.78	0.87	0.87	0.54	0.64
12 (3.66)	144 (366)	0.61	0.36	0.25	0.70	0.89	0.60	0.76	0.84	0.91	0.24	0.36	0.70	0.54	0.45	0.76	0.82	0.60	0.71	0.82	0.83	0.43	0.53
14 (4.27)	168 (427)	0.55	0.32	0.23	0.66	0.86	0.55	0.73	0.81	0.89	0.22	0.32	0.63	0.45	0.38	0.70	0.78	0.51	0.64	0.77	0.78	0.35	0.45
16 (4.88)	192 (488)	0.51	0.30	0.21	0.62	0.84	0.50	0.69	0.78	0.87	0.21	0.30	0.56	0.39	0.32	0.64	0.73	0.44	0.57	0.72	0.73	0.30	0.39
18 (5.49)	216 (549)	0.47	0.28	0.19	0.58	0.81	0.47	0.65	0.75	0.84	0.19	0.28	0.49	0.34	0.28	0.58	0.68	0.39	0.50	0.67	0.68	0.27	0.34
20 (6.10)	240 (610)	0.44	0.26	0.18	0.54	0.78	0.43	0.61	0.72	0.82	0.18	0.26	0.44	0.31	0.25	0.52	0.63	0.35	0.45	0.62	0.63	0.24	0.30

**BEARING LOADS ON UNISTRUT CHANNEL**

Channel	Bearing Length 1 1/8" (41 mm) Maximum Allowable Loads Lbs (kN)		Bearing Length 1 1/8" (41 mm) Maximum Allowable Loads Lbs (kN)		Bearing Length 3/4" (82 mm) Maximum Allowable Loads Lbs (kN)	
	P1000	6,700 29.80	3,100 13.79	7,700 34.25		
P1100	3,500 15.57	1,700 7.56	4,000 17.79			
P2000	2,500 11.12	1,200 5.34	3,000 13.34			
P3000	6,700 29.80	3,200 14.23	7,700 34.25			
P3300	6,800 30.25	3,200 14.23	7,800 34.70			
P4000	2,600 11.57	1,200 5.34	3,000 13.34			
P4100	3,500 15.57	1,800 8.01	4,100 18.24			
P4400	7,300 32.47	3,400 15.12	8,400 37.37			
P4520	7,300 32.47	3,400 15.12	8,400 37.37			
P5000	6,500 28.91	3,000 13.34	7,500 33.36			
P5500	6,600 29.36	3,100 13.79	7,600 33.81			

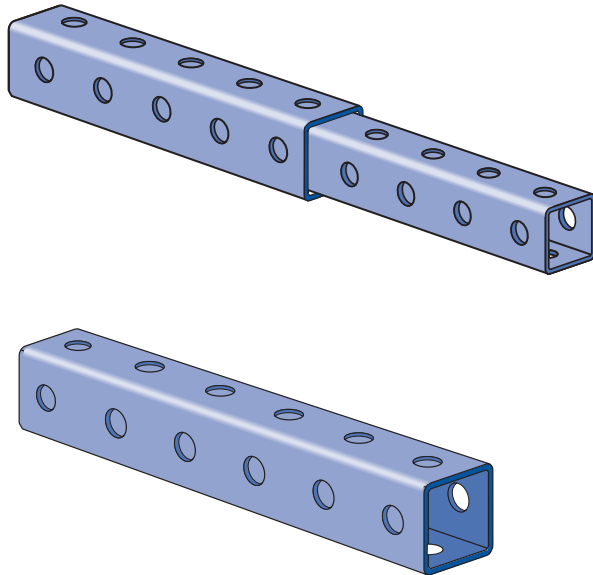

Telescoping Tube..... 65-67

Specialized Fittings..... 68

Connection Methods..... 69

Post Bases..... 68-69

Cutting Chart..... 70

**MATERIAL**

TELESTRUT is accurately and carefully cold formed to size from low-carbon strip steel.

**STEEL: PLAIN**

12 Ga. (2.7 mm), ASTM A1011 SS GR 33.

**STEEL: PRE-GALVANIZED**

12 Ga. (2.7 mm), ASTM A653 GR 33.

**FINISHES**

Telestrut is available in:

- Plain (PL)
- Pre-Galvanized (PG)
- Green powder coat (GR)

Fittings are available in:

- Green Powder Coat (GR), conforming to commercial standards for Powder Coating
- Electro-galvanized (EG), conforming to ASTM B633 Type III SC1
- Hot-dipped Galvanized (HG), conforming to ASTM A153
- Plain (PL)

**DIMENSIONS**

Imperial dimensions are illustrated in inches. Metric dimensions are shown in parenthesis or as noted. Unless noted, all metric dimensions are in millimeters and rounded to one decimal place.

**DESIGN BOLT TORQUE**

BOLT SIZE	¼"-20	⅝"-18	⅜"-16	½"-13	⅝"-11	¾"-10
Rec. Torque Ft/Lbs (Nm)	6 (8)	11 (15)	19 (26)	50 (68)	100 (136)	125 (170)
Max Torque Ft/Lbs (Nm)	7 (9)	15 (20)	25 (34)	70 (95)	125 (170)	135 (183)

**DESIGN LOAD**

Load tables and charts are constructed to be in accordance with the SPECIFICATION FOR THE DESIGN OF COLD-FORMED STEEL STRUCTURAL MEMBERS 2007 EDITION published by the AMERICAN IRON AND STEEL INSTITUTE USING ASD METHOD.

Type of Load	Safety Factor to Yield Strength
Beam Loads	1.67
Column Load	1.80



1 1/8" Channel

Telestrut

Nuts & Hardware

General Fittings

Pipe/Conduit Supports

Electrical Fittings

Concrete Inserts

Solar

Unipier®

**Telestrut Telescoping Tubing**

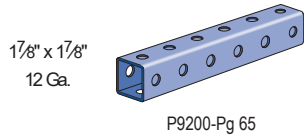
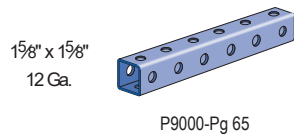

**Special Fittings and Post Bases for Telestrut Telescoping Tubing**

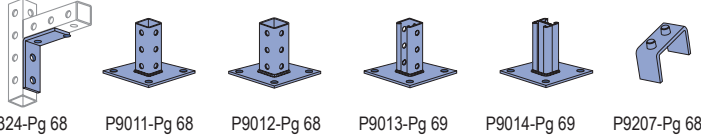

**Standard 1 1/8" – Flat Plate Fittings**

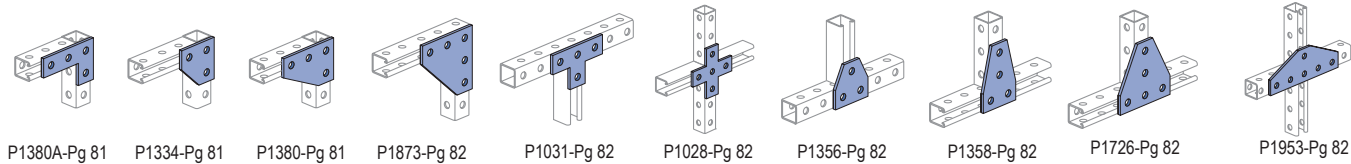
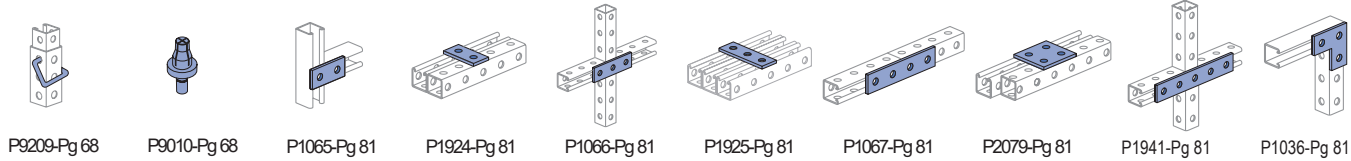

**Standard 1 1/8" – Ninety Degree Fittings**

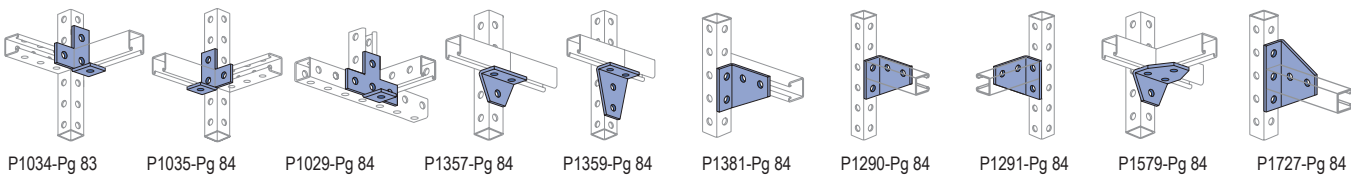
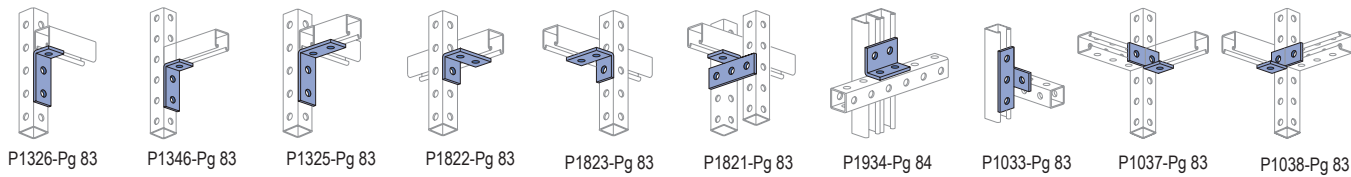
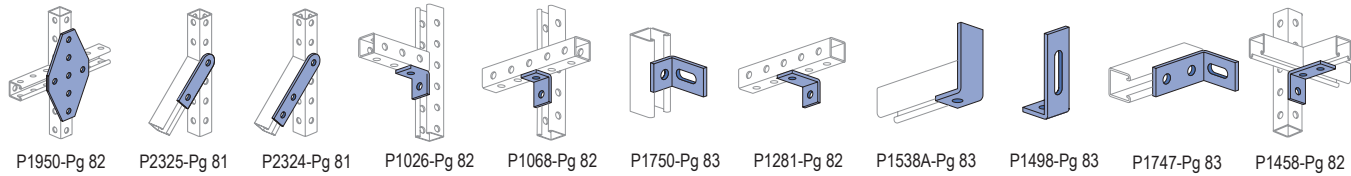

**Standard 1 1/8" – "Z" and "U" Shape Fittings**

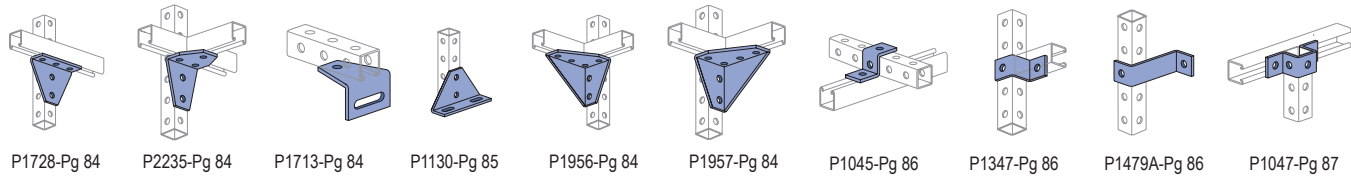

**Standard 1 1/8" – Wing Shape Fittings**

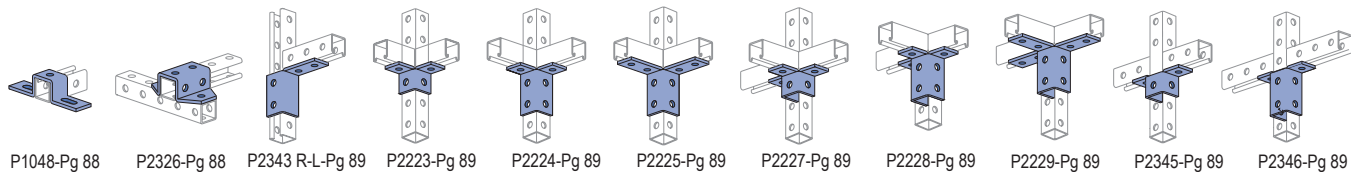



**Telestrut Pictorial Index**

**Standard 1 5/8" Metal Framing – Wing Shape Fittings**

**Standard 1 5/8" – Misc. Fittings**

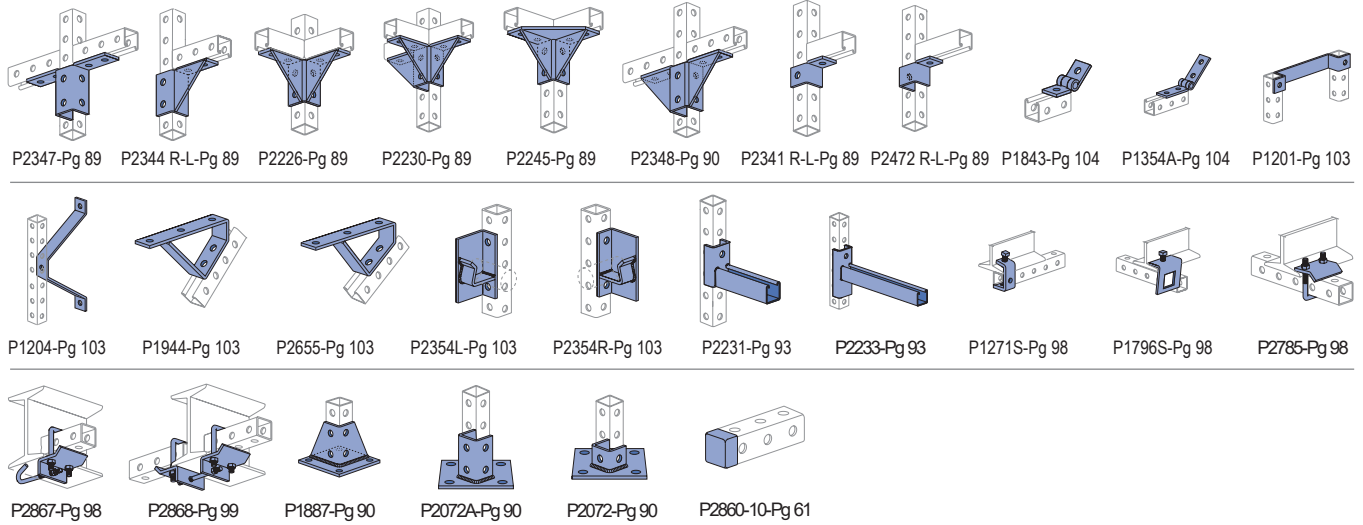

Many of the standard metal framing components are compatible with the Telestrut telescoping tubing. Refer to the appropriate page in other sections of the catalog for information on the particular fittings shown here.

**P9000**

**GR PG**

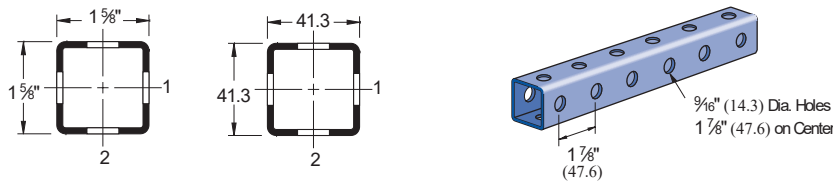

W/100 Ft: 188 Lbs (279 kg/100 m)  
Allowable Moment 5,140 In-Lbs (580 N·m)  
12 Gauge Nominal Thickness .105" (2.7mm)

**P9200**

**GR PG**

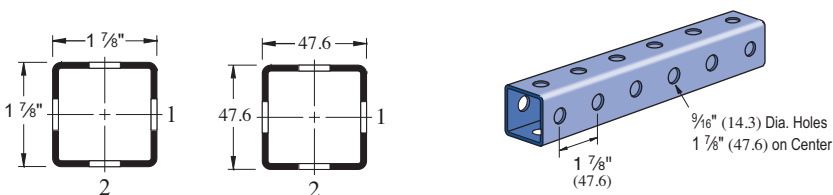

W/100 Ft: 223 Lbs (331 kg/100 m)  
Allowable Moment 7,480 In-Lbs (850 N·m)  
12 Gauge Nominal Thickness .105" (2.7mm)

**TELESTRUT'S TELESCOPING POWER**

Telestrut can be combined with metal framing channel

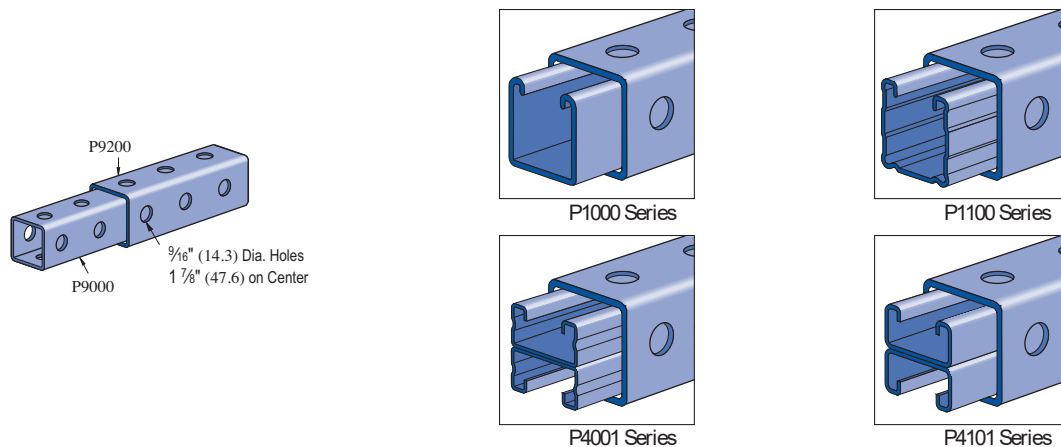

Note: Will not telescope with GR or HG finish



1 1/8" Channel

Telestrut

Nuts & Hardware

General Fittings

Pipe/Conduit Supports

Electrical Fittings

Concrete Inserts

Solar

Unipier®

**P9000 - BEAM LOADING**

Span In	Max Allowable Uniform Load Lbs	Defl. at Uniform Load In	Uniform Loading at Deflection		
			Span/180 Lbs	Span/240 Lbs	Span/360 Lbs
24	1,710	0.06	1,710	1,710	1,710
36	1,140	0.14	1,140	1,140	810
48	860	0.25	860	680	450
60	690	0.40	580	440	290
72	570	0.57	400	300	200
84	490	0.77	300	220	150
96	430	1.01	230	170	110
108	380	1.27	180	130	90
120	340	1.56	150	110	70
144	290	2.30	100	80	50
168	240	3.02	70	60	40
192	210	3.95	60	40	NR
216	190	5.09	40	NR	NR
240	170	6.24	40	NR	NR

**P9200 - BEAM LOADING**

Span In	Max Allowable Uniform Load Lbs	Defl. at Uniform Load In	Uniform Loading at Deflection		
			Span/180 Lbs	Span/240 Lbs	Span/360 Lbs
24	2,490	0.05	2,490	2,490	2,490
36	1,660	0.12	1,660	1,660	1,350
48	1,250	0.22	1,250	1,140	760
60	1,000	0.34	980	730	490
72	830	0.49	680	510	340
84	710	0.67	500	370	250
96	620	0.87	380	290	190
108	550	1.10	300	230	150
120	500	1.37	240	180	120
144	420	1.98	170	130	80
168	360	2.70	120	90	60
192	310	3.47	100	70	50
216	280	4.47	80	60	NR
240	250	5.47	60	50	NR

**P9000 - COLUMN LOADING**

Unbraced Height In	Maximum Allowable Load at Slot Face Lbs	Maximum Column Load Applied at C.G.			
		K = 0.65 Lbs	K = 0.80 Lbs	K = 1.0 Lbs	K = 1.2 Lbs
24	3,640	8,730	8,570	8,330	8,040
36	3,540	8,360	8,040	7,530	6,950
48	3,400	7,880	7,340	6,530	5,660
60	3,210	7,290	6,530	5,440	4,360
72	2,990	6,640	5,660	4,360	3,160
84	2,730	5,940	4,790	3,340	2,320
96	2,430	5,220	3,940	2,560	1,780
108	2,110	4,520	3,160	2,020	1,400
120	1,820	3,840	2,560	1,640	**
144	1,390	2,690	1,780	**	**

**P9200 - COLUMN LOADING**

Unbraced Height In	Maximum Allowable Load at Slot Face Lbs	Maximum Column Load Applied at C.G.			
		K = 0.65 Lbs	K = 0.80 Lbs	K = 1.0 Lbs	K = 1.2 Lbs
24	4,620	11,120	10,980	10,740	10,460
36	4,530	10,770	10,460	9,950	9,370
48	4,390	10,300	9,760	8,940	8,030
60	4,220	9,720	8,940	7,800	6,590
72	4,000	9,050	8,030	6,590	5,180
84	3,750	8,320	7,080	5,410	3,890
96	3,460	7,560	6,110	4,290	2,980
108	3,140	6,770	5,180	3,390	2,360
120	2,790	5,990	4,290	2,750	1,910
144	2,170	4,510	2,980	1,910	**
168	1,720	3,320	2,190	**	**

**P9000/P9200 - ELEMENTS OF SECTION**

Parameter	P9000		P9200	
Area of Section	0.387	In <sup>2</sup>	0.489	In <sup>2</sup>
Axis 1-1				
Moment of Inertia (I)	0.166	In <sup>4</sup>	0.279	In <sup>4</sup>
Section Modulus (S)	0.205	In <sup>3</sup>	0.297	In <sup>3</sup>
Radius of Gyration (r)	0.655	In	0.755	In
Axis 2-2				
Moment of Inertia (I)	0.166	In <sup>4</sup>	0.279	In <sup>4</sup>
Section Modulus (S)	0.205	In <sup>3</sup>	0.297	In <sup>3</sup>
Radius of Gyration (r)	0.655	In	0.755	In

Notes:

\* Load limited by spot weld shear.

\*\* KL/r > 200

NR = Not Recommended.

1. Beam loads are given in total uniform load (W Lbs) not uniform load (w lbs/ft or w lbs/in).
4. Deduct Telestrut weight from the beam loads.
5. For concentrated midspan point loads, multiply beam loads by 50% and the corresponding deflection by 80%. For other load conditions refer to page 18.

# P9000 & P9200 Telestrut Channels

## P9000 - BEAM LOADING (METRIC)

Span mm	Max Allowable Uniform Load kN	Defl. at Uniform Load mm	Uniform Loading at Deflection		
			Span/180 kN	Span/z0 kN	Span/360 kN
600	7.7	2	7.7	7.7	7.7
750	6.2	2	6.2	6.2	5.3
1,000	4.7	4	4.7	4.5	3.0
1,250	3.7	7	3.7	2.9	1.9
1,500	3.1	10	2.7	2.0	1.3
1,750	2.7	13	2.0	1.5	1.0
2,000	2.3	17	1.5	1.1	0.8
2,500	1.9	27	1.0	0.7	0.5
3,000	1.6	39	0.7	0.5	0.3
3,500	1.3	53	0.5	0.4	0.3
4,000	1.2	68	0.4	0.3	0.2
4,500	1.0	86	0.3	0.2	0.1
5,000	0.9	108	0.2	0.2	NR
6,000	0.8	151	0.2	NR	NR

## P9200 - BEAM LOADING (METRIC)

Span mm	Max Allowable Uniform Load kN	Defl. at Uniform Load mm	Uniform Loading at Deflection		
			Span/180 kN	Span/240 kN	Span/360 kN
600	11.3	1	11.3	11.3	11.3
750	9.0	2	9.0	9.0	8.9
1,000	6.8	4	6.8	6.8	5.0
1,250	5.4	6	5.4	4.8	3.2
1,500	4.5	8	4.5	3.3	2.2
1,750	3.9	11	3.3	2.4	1.6
2,000	3.4	15	2.5	1.9	1.2
2,500	2.7	23	1.6	1.2	0.8
3,000	2.3	34	1.1	0.8	0.6
3,500	1.9	45	0.8	0.6	0.4
4,000	1.7	60	0.6	0.5	0.3
4,500	1.5	76	0.5	0.4	0.3
5,000	1.3	92	0.4	0.3	0.2
6,000	1.1	132	0.3	0.2	NR

## P9000 - COLUMN LOADING (METRIC)

Unbraced Height mm	Maximum Allowable Load at Slot Face kN	Maximum Column Load Applied at C.G.			
		K = 0.65 kN	K = 0.80 kN	K = 1.0 kN	K = 1.2 kN
600	16.2	38.9	38.2	37.1	35.9
750	16.0	38.2	37.1	35.5	33.7
1,000	15.6	36.7	35.0	32.3	29.4
1,250	15.0	34.8	32.3	28.6	24.6
1,500	14.4	32.6	29.4	24.6	19.8
1,750	13.6	30.3	26.2	20.6	15.3
2,000	12.7	27.8	23.0	16.8	11.7
2,250	11.7	25.2	19.8	13.3	9.3
2,500	10.5	22.6	16.8	10.8	7.5
2,750	9.3	20.0	14.0	8.9	6.2

## P9200 - COLUMN LOADING (METRIC)

Unbraced Height mm	Maximum Allowable Load at Slot Face kN	Maximum Column Load Applied at C.G.			
		K = 0.65 kN	K = 0.80 kN	K = 1.0 kN	K = 1.2 kN
600	20.6	49.5	48.9	47.9	46.6
750	20.4	48.8	47.9	46.3	44.4
1,000	20.0	47.4	45.7	43.1	40.1
1,250	19.5	45.6	43.1	39.3	35.1
1,500	18.8	43.5	40.1	35.1	29.9
1,750	18.1	41.1	36.8	30.7	24.6
2,000	17.2	38.5	33.4	26.3	19.7
2,250	16.2	35.7	29.9	22.1	15.6
2,500	15.1	32.9	26.3	18.2	12.6
2,750	13.9	30.1	23.0	15.0	10.4

## P9000/P9200 - ELEMENTS OF SECTION (METRIC)

Parameter	P9000		P9200	
Area of Section	2.50	cm <sup>2</sup>	3.16	cm <sup>2</sup>
Axis 1-1				
Moment of Inertia (I)	6.92	cm <sup>4</sup>	11.61	cm <sup>4</sup>
Section Modulus (S)	3.35	cm <sup>3</sup>	4.87	cm <sup>3</sup>
Radius of Gyration (r)	1.66	cm	1.92	cm
Axis 2-2				
Moment of Inertia (I)	6.92	cm <sup>4</sup>	11.61	cm <sup>4</sup>
Section Modulus (S)	3.35	cm <sup>3</sup>	4.87	cm <sup>3</sup>
Radius of Gyration (r)	1.66	cm	1.92	cm

### Notes:

\* Load limited by spot weld shear.

\*\* KL/r > 200

NR = Not Recommended.

1. Beam loads are given in total uniform load (WLbs) not uniform load (w lbs/ft or w lbs/in).
4. Deduct Telestrut weight from the beam loads.
5. For concentrated midspan point loads, multiply beam loads by 50% and the corresponding deflection by 80%. For other load conditions refer to page 18.



1 1/8" Channel

Telestrut

Nuts & Hardware

General Fittings

Pipe/Conduit Supports

Electrical Fittings

Concrete Inserts

Solar

Unipier®

**P9010**

**MULTI-GRIP RIVET**

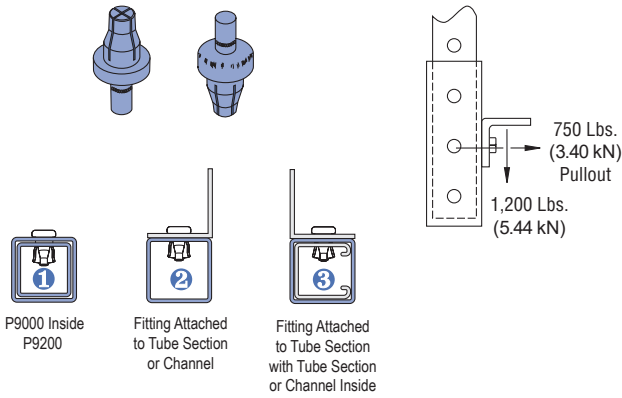

W/100 pcs: 10 Lbs (4.5 kg)

**P9209**

**GRAVITY PIN**

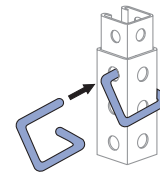

W/100 pcs: 47 Lbs (21.3 kg)

**P9207**

**CUTTING ALIGNMENT GAUGE**

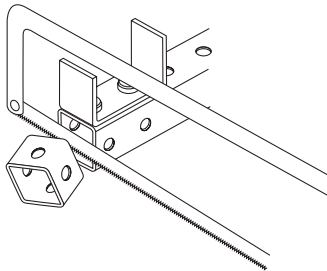
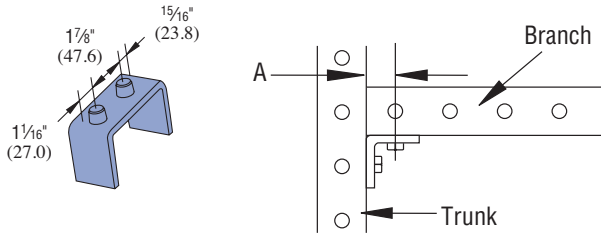

The cutting alignment guide ensures correct cutting of branch members when used with fittings to make connections. Refer to the table of page 70 for the appropriate value for "A" for cutting.

**P9324**

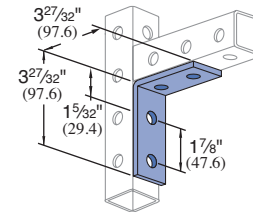

W/100 pcs: 78 Lbs (35.0 kg)

**P9011**

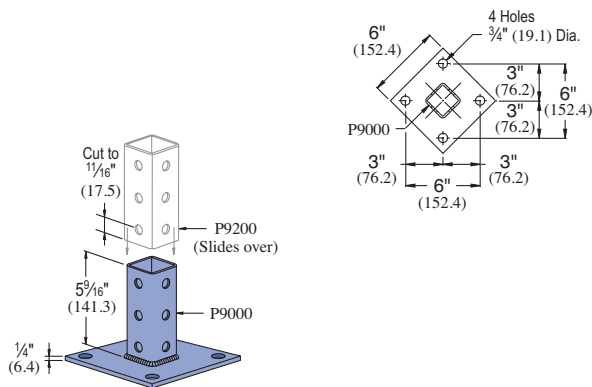

W/100 pcs: 332 Lbs (150.7 kg)

**P9012**

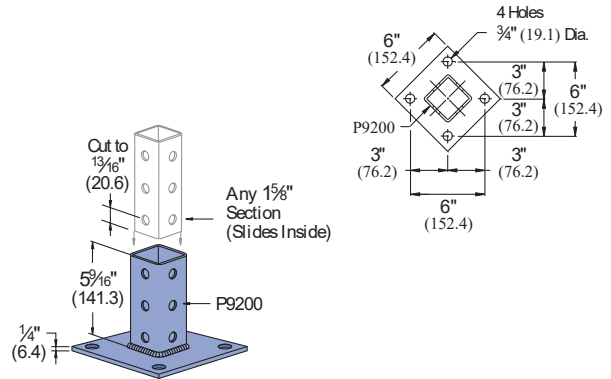

W/100 pcs: 340 Lbs (154 kg)

Standard Dimensions for 1 1/8" (41.3mm) width series channel fittings (Unless Otherwise Shown on Drawing)

Hole Diameter: 9/16" (14mm); Hole Spacing - From End: 1 9/16" (21mm); Hole Spacing - On Center: 1 7/8" (48mm); Width: 1 1/8" (41.3mm); Thickness: 1/4" (6mm)

**Post Bases & Telestrut Connection Methods**

**P9014**

**EG, GR**

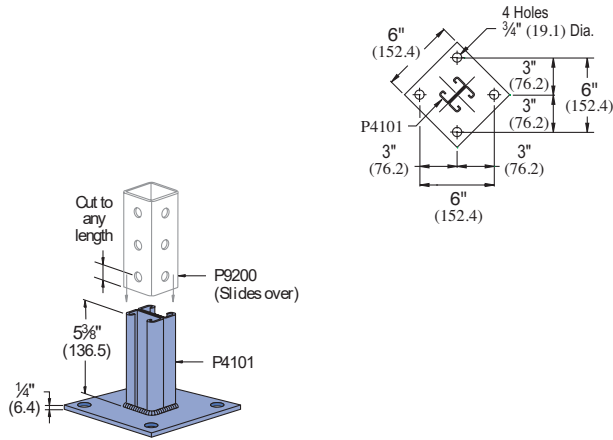

Wt/100 pcs: 303 Lbs (137.5 kg)

**PREFERRED THREE-PIECE ASSEMBLY**

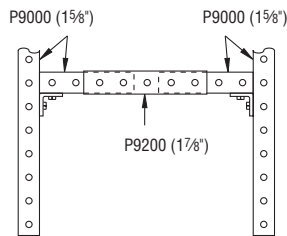

In most applications, telescoping assemblies should be made from three sections of Telestrut material. The simplest construction utilizes a center section of 1 7/8" material (P9200) into which a 1 5/8" member (P9000) is telescoped from each end. In this way, all intersecting verticals and horizontals are formed from 1 5/8" members assuring maximum compatibility and ease of assembly

**TWO-PIECE ASSEMBLY**

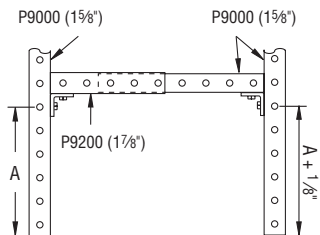

Two-piece telescoping assemblies can be used, but special cutting of one or both telescoping members is needed to achieve proper alignment of fittings at the intersecting connections.

In addition, the right-angle members to which telescoping pieces are attached must be cut according to the illustration at right to insure smooth movement of telescoping members.

**P9013**

**EG, GR**

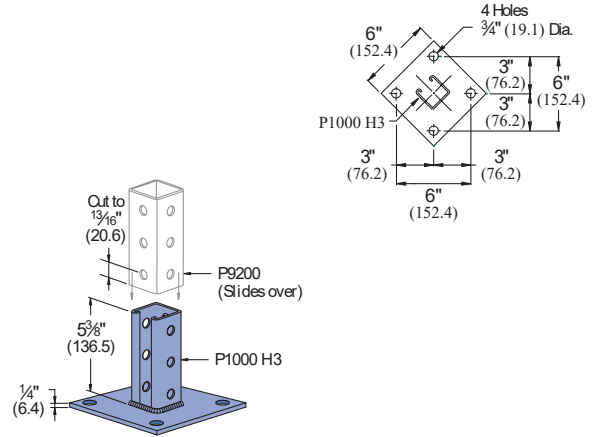

Wt/100 pcs: 318 Lbs (144.7 kg)

**ALTERNATE THREE-PIECE ASSEMBLY**

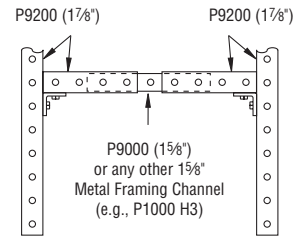

A similar technique is to use a center 1 5/8" center member (P9000) which can be telescoped into 1 7/8" members used at both ends. With this method, all intersecting connections should be formed from compatible 1 7/8" members.

**CHANNEL NUT CONNECTION – INFINITE ADJUSTMENT**

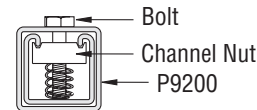

Any of the 1 5/8" (41.3 mm) channel can be connected to the P9000 using standard channel nuts.

**THROUGH-BOLT CONNECTION – INCREMENTAL ADJUSTMENT**

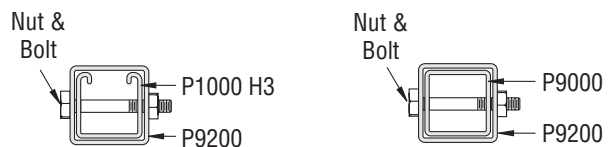

Standard Dimensions for 1 5/8" (41.3mm) width series channel fittings (Unless Otherwise Shown on Drawing)

Hole Diameter: 3/16" (14mm); Hole Spacing - From End: 1 3/16" (21mm); Hole Spacing - On Center: 1 7/8" (48mm); Width: 1 5/8" (41.3mm); Thickness: 1/4" (6mm)



**CUTTING CHART**

Fitting	1/8" (41.3) Branch		1/8" (47.6) Branch	
	Trunk 1/8" (41.3)	Trunk 1/8" (47.6)	Trunk 1/8" (41.3)	Trunk 1/8" (47.6)
P1026	A	A	A	B
P1028	A	A	A	B
P1029	†	†	†	†
P1031	A	A	A	B
P1033	B	A	A	B
P1034	†	†	†	†
P1035	A	†	†	†
P1036	A	A	A	B
P1037	†	†	†	†
P1038	†	†	†	†
P1045	†	†	†	†
P1047	†	†	†	†
P1048	†	†	†	†
P1049	†	†	†	†
P1050	†	†	†	†
P1065	A	A	A	B
P1066	A	A	A	B
P1068	C	NR	NR	NR
P1130	A	A	A	C
P1131	A	A	A	C
P1290	A	NR	NR	NR
P1291	A	NR	NR	NR
P1325	A	NR	NR	NR
P1326	C	NR	NR	NR
P1334	A	A	A	B
P1346	A	A	A	B
P1347	C	NR	NR	NR
P1354	D	D	D	D
P1356	A	A	A	B
P1357	A	NR	NR	NR
P1358	A	A	A	B
P1359	A	NR	NR	NR
P1380	A	A	A	B
P1380 A	A	A	A	B
P1381	†	†	†	†
P1382	†	†	†	†
P1458	A	NR	NR	NR
P1498	†	†	†	†
P1499	†	†	†	†
P1538 A	C	A	A	C
P1538 B	C	A	A	C
P1538 C	C	A	A	C
P1538 D	C	A	A	C
P1579	A	NR	NR	NR
P1713	†	†	†	†

Fitting	1/8" (41.3) Branch		1/8" (47.6) Branch	
	Trunk 1/8" (41.3)	Trunk 1/8" (47.6)	Trunk 1/8" (41.3)	Trunk 1/8" (47.6)
P1726	A	A	A	B
P1727	B	NR	NR	NR
P1728	†	†	†	†
P1747	†	†	†	†
P1750	†	†	†	†
P1821	†	†	†	†
P1822	†	†	†	†
P1823	†	†	†	†
P1843	D	D	D	D
P1873	†	†	†	†
P1834	†	NR	NR	NR
P1941	A	A	A	B
P1950	A	A	A	B
P1953	A	A	A	B
P1956	†	†	†	†
P1957	†	†	†	†
P2223	A	NR	A	NR
P2224	A	NR	A	NR
P2225	A	NR	A	NR
P2226	A	NR	A	NR
P2227	A	NR	A	NR
P2228	A	NR	A	NR
P2229	A	NR	A	NR
P2230	A	NR	A	NR
P2235	A	NR	NR	NR
P2245	A	NR	A	NR
P2324	E	NR	NR	F
P2325	E	A	A	F
P2326	E	NR	NR	F
P2341 R-L	A	NR	A	NR
P2343 R-L	A	NR	A	NR
P2344 R-L	A	NR	A	NR
P2345	A	NR	A	NR
P2346	A	NR	A	NR
P2347	A	NR	A	NR
P2348	A	NR	A	NR
P2472 R-L	C	NR	A	NR
P2815	C	NR	NR	NR
P2815 D	C	NR	NR	NR
P9324	G	G	G	G
P9325	A	A	A	A
P9484	A	A	A	A

This table shows the value for "A" when using the specified fitting to connect the branch and trunk. Sizes "A" and "B" can be cut with the cutting alignment gauge (P9207). Other sizes require special cutting. Those marked NR are not recommended.

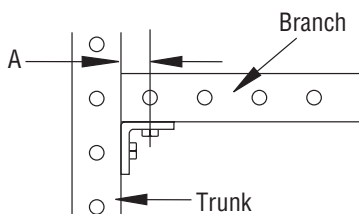

**Legend**

Designator	"A" In (mm)
A	1/16" 27.0
B	15/16" 23.8
C	13/16" 20.6
D	1/4" 31.8
E	9/16" * 15.9

Designator	"A" In (mm)
F	7/16" * 11.1
G	15/32" 29.4
NR	Not Recommended
†	Special Cutting Req'd (See part dwg)

# NUTS & HARDWARE

Channel Nuts With Springs .....	73
Channel Nuts Without Springs .....	73
Top Retainer Nuts .....	73
Stud Nuts .....	74
Hardware .....	74-76

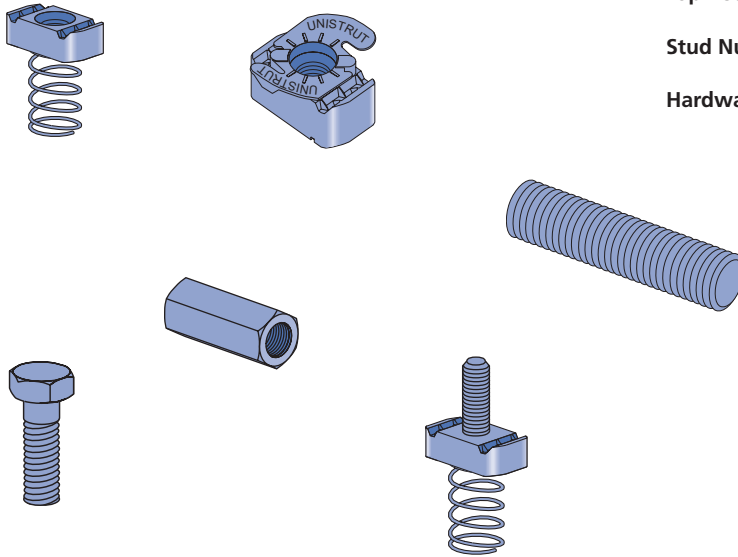

## MATERIAL

Unistrut channel nuts are manufactured from mild steel cold rolled coil, and after stamping and machining operations are completed, they are case hardened, assuring positive biting action into the inturned edge of the Unistrut channel.

Screws conform to SAE J429 GR 2 (exceeds ASTM A307). Proof Load 55KSI, Tensile Load 74 KSI

Bolt Size	Channel Nut ASTM
1/4" & 5/16"	A1011 SS GR33
3/8", 7/16" & 1/2"	A576 GR1015 Modified
5/8" & 3/4"	A36 or A675 GR60
7/8"	A36

## FINISHES

All Channel nuts are available in:

Electro-galvanized (EG), conforming to ASTM B633 type III SC1

Hot-dipped galvanized (HG), conforming to ASTM A153

Plain (PL)

Unistrut Defender™ (DF), conforming to ASTM A1059

Hardware items such as Hex Nuts bolts and washers are Electro-Galvanized (EG), ASTM B633 Type III SC1 finish, unless otherwise noted.

Many hardware items are also available in stainless steel. Consult factory for ordering information.

## THREADS

Unistrut nuts and bolts are manufactured to meet the Unified Screw Thread standard, ANSI B1.1, coarse series (UNC) class 2.

## DESIGN BOLT TORQUE

BOLT SIZE	1/4"-20	5/16"-18	3/8"-16	1/2"-13	5/8"-11	3/4"-10
Rec. Torque Ft/Lbs ( <i>Nm</i> )	6 (8)	11 (15)	19 (26)	50 (68)	100 (136)	125 (170)
Max Torque Ft/Lbs ( <i>Nm</i> )	7 (9)	15 (20)	25 (34)	70 (95)	125 (170)	135 (183)

## DIMENSIONS

Imperial dimensions are illustrated in inches. Metric dimensions are shown in parenthesis or as noted.

Unless noted, all metric dimensions are in millimeters and rounded to one decimal place.

Many Unistrut nuts, bolts and hardware items are also available in standard metric dimensions. Consult factory for ordering information.



**Channel Nuts With Spring**

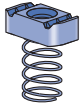

P1006 - P1010  
Pg 73

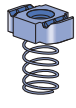

P1012S - P1024S  
Pg 73



P4006 - P4010  
Pg 73



P5506 - P5510  
Pg 73

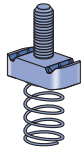

P2378 - P2382  
Pg 74

**Channel Nuts Without Spring**



P3016  
Pg 73



P3006 - P3013  
Pg 73



P1012 - P1024  
Pg 73



P4012 - P4023  
Pg 73



P1006T - P1010T, P4010T  
Pg 73

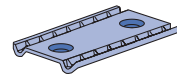

P4908  
Pg 73



P1016  
Pg 73

**Hardware**



HHCS  
Pg 74



HFMS  
Pg 74



HRMS  
Pg 74



HSHS  
Pg 74



HCSS  
Pg 74



HSQN  
Pg 75



HHXN  
Pg 75



HFLW  
Pg 75



HLKW  
Pg 75

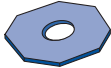

HOCW  
Pg 76

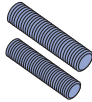

HTHR  
Pg 75



HRCN  
Pg 75



P2486  
Pg 76



P2485  
Pg 76



P2485K  
Pg 76

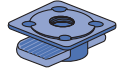

K1062 - K1064  
Pg 76

**MAXIMUM ALLOWABLE PULL-OUT AND SLIP LOADS**

Channel	Channel Nut Size-Thread	Gauge	Allowable Pull-Out Strength Lbs (kN)	Resistance to Slip Lbs (kN)	Torque Ft-Lbs (N•m)
P1000 P3000 P4400 P4526 P5000 P5500	7/8" - 9	12	2,500	1,700	*125
			11.12	7.56	170
	3/4" - 10	12	2,500	1,700	*125
			11.12	7.56	170
	5/8" - 11	12	2,500	1,500	*100
			11.12	6.67	135
	1/2" - 13	12	2,000	1,500	50
			8.90	6.67	70
7/16" - 14	12	1,400	1,000	35	
		6.23	4.45	50	
3/8" - 16	12	1,000	800	19	
		4.45	3.56	25	
5/16" - 18	12	800	500	11	
		3.56	2.22	15	
1/4" - 20	12	600	300	6	
		2.67	1.33	8	
P3300	1/2" - 13	12	1,500	1,500	50
			6.67	6.67	70
	3/8" - 16	12	1,000	800	19
			4.45	3.56	25
5/16" - 18	12	800	500	11	
		3.56	2.22	15	
1/4" - 20	12	600	300	6	
		2.67	1.33	8	

Channel	Channel Nut Size-Thread	Gauge	Allowable Pull-Out Strength Lbs (kN)	Resistance to Slip Lbs (kN)	Torque Ft-Lbs (N•m)
P1100 & P4100	1/2" - 13	14	1,400	1,000	50
			6.23	4.45	70
	3/8" - 16	14	1,000	750	19
			4.45	3.34	25
5/16" - 18	14	800	400	11	
		3.56	1.78	15	
1/4" - 20	14	600	300	6	
		2.67	1.33	8	
P2000 & P4000	1/2" - 13	16	1,000	1,000	50
			4.45	4.54	70
	3/8" - 16	16	1,000	750	19
			4.45	3.34	25
5/16" - 18	16	800	400	11	
		3.56	1.78	15	
1/4" - 20	16	600	300	6	
		2.67	1.33	8	

\* May require 3/8" or 1/2" thick fitting.

Nut design loads include a minimum safety factor of 3.

Note: Refer to the Channel Nut Selection Chart on the following two pages for the part number.



## CHANNEL NUT WITH SPRING

EG, HG

	Part Number	Nut Size Thread	Wt/100 pcs Lbs (kg)	Use With
	P1006-0832	#8 -32	7 (3.2)	P1000, P1100, P2000, P3000
P1006-1024	#10 -24	7 (3.2)		
P1006-1420	¼" -20	7 (3.2)		
P1007	⅝" -18	6 (2.7)		
P1008	⅜" -16	10 (4.5)		
P1009	⅞" -14	9 (4.1)		
P1010	½" -13	12 (5.4)		

	Part Number	Nut Size Thread	Wt/100 pcs Lbs (kg)	Use With
	P1012S	⅝" -11	21 (9.5)	P1000, P1100, P2000, P3000
P1023S	¾" -10	21 (9.5)		
P1024S	⅞" -9	21 (9.5)		

	Part Number	Nut Size Thread	Wt/100 pcs Lbs (kg)	Use With
	P4006-0832	#8 -32	7 (3.2)	P3300, P4000, P4400, P4520, P4100
P4006-1024	#10 -24	7 (3.2)		
P4006-1420	¼" -20	7 (3.2)		
P4007	⅝" -18	6 (2.7)		
P4008	⅜" -16	9 (4.1)		
P4009	⅞" -14	9 (4.1)		
P4010	½" -13	8 (3.6)		

	Part Number	Nut Size Thread	Wt/100 pcs Lbs (kg)	Use With
	P5506-0832	#8 -32	7 (3.2)	P5000, P5500
P5506-1024	#10 -24	7 (3.2)		
P5506-1420	¼" -20	7 (3.2)		
P5507	⅝" -18	6 (2.7)		
P5508	⅜" -16	10 (4.5)		
P5509	⅞" -14	10 (4.5)		
P5510	½" -13	12 (5.4)		

## CHANNEL NUT WITHOUT SPRING

EG, HG

	Part Number	Nut Size Thread	Wt/100 pcs Lbs (kg)	Use With
	P3016-0632	#6 -32	2 (0.9)	Any Channel
P3016-0832	#8 -32	2 (0.9)		
P3016-1024	#10 -24	4 (1.8)		
P3016-1420	¼" -20	4 (1.8)		

	Part Number	Nut Size Thread	Wt/100 pcs Lbs (kg)	Use With
	P3006-0832	#8 -32	6 (2.7)	Any Channel
P3006-1024	#10 -24	6 (2.7)		
P3006-1420	¼" -20	6 (2.7)		
P3007	⅝" -18	6 (2.7)		
P3008	⅜" -16	9 (4.1)		

	Part Number	Nut Size Thread	Wt/100 pcs Lbs (kg)	Use With
	P3010	½" -13	11 (5.0)	Any Channel Except P3300, P4000, P4400, P4520, P4100
P3013	½" -13	8 (3.6)		

	Part Number	Nut Size Thread	Wt/100 pcs Lbs (kg)	Use With
	P1012	⅝" -11	20 (9.1)	Any Channel Except P3300, P4000, P4400, P4520, P4100
P1023	¾" -10	20 (9.1)		
P1024	⅞" -9	20 (9.1)		

	Part Number	Nut Size Thread	Wt/100 pcs Lbs (kg)	Use With
	P4012	⅝" -11	11 (5.0)	P3300, P4000, P4400, P4520, P4100
P4023	¾" -10	11 (5.0)		

	Part Number	Nut Size Thread	Wt/100 pcs Lbs (kg)	Use With
	P1006T1420	¼" -20	7 (3.2)	Any Channel
P1008T	⅜" -16	10 (4.5)		

	Part Number	Nut Size Thread	Wt/100 pcs Lbs (kg)	Use With
	P1010T	½" -13	12 (5.4)	Any Channel Except P3300, P4000, P4400, P4520, P4100
P4010T	½" -13	8 (3.6)		

	Part Number	Nut Size Thread	Wt/100 pcs Lbs (kg)	Use With
	P4908	⅜" -16	17.5 (7.9)	Any Channel
Double Conveyor Adjusting Nut				

	Part Number	Nut Size Thread	Wt/100 pcs Lbs (kg)	Use With
	P1016	⅜" -16	17.5 (7.9)	Any "T" Slotted Channel
Missing Link Multi-Purpose Strut Fastener				

1 1/8" Channel

Telestrut

Nuts & Hardware

General Fittings

Pipe/Conduit Supports

Electrical Fittings

Concrete Inserts

Solar

Unipier®



**CHANNEL STUD NUT WITH SPRING**

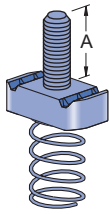

All Stud Nut grooves are serrated.

Part No.	Thread	"A" Stud In (mm)	Wt/100 pcs Lbs (kg)	Use With P1000, P1100, P2000, P3000
P2378-1	1/4" - 20	1 (25.4)	8 (3.6)	
P2378-2		1 1/4 (31.8)	9 (4.1)	
P2378-3		1 1/2 (38.1)	9 (4.1)	
P2379-1	5/16" - 18	1 (25.4)	12 (5.4)	
P2379-2		1 1/4 (31.8)	12 (5.4)	
P2379-3		1 1/2 (38.1)	13 (5.9)	
P2380-1	3/8" - 16	1 (25.4)	13 (5.9)	
P2380-2		1 1/4 (31.8)	13 (5.9)	
P2380-3		1 1/2 (38.1)	13 (5.9)	
P2380-4		1 3/4 (44.5)	15 (6.8)	

Part No.	Thread	"A" Stud In (mm)	Wt/100 pcs Lbs (kg)	Use With P1000, P1100, P2000, P3000
P2380-5	3/8" - 16	2 (50.8)	16 (7.3)	
P2380-6		2 1/4 (57.2)	16 (7.3)	
P2381-2	1/2" - 13	1 (25.4)	14 (6.4)	
P2381-3		1 1/4 (31.8)	15 (6.8)	
P2381-4		1 1/2 (38.1)	17 (7.7)	
P2381-5		1 3/4 (44.5)	18 (8.2)	
P2381-6		2 (50.8)	19 (8.6)	
P2381-7		2 1/4 (57.2)	20 (9.1)	
P2382-2	5/8" - 11	1 1/4 (31.8)	18 (8.2)	
P2382-3		1 1/2 (38.1)	20 (9.1)	

**HEX HEAD CAP SCREWS**

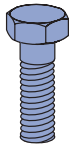

Part No.	Size	Wt/100 pcs Lbs (kg)
HHCS025044EG	1/4" x 7/16"	1.0 (0.5)
HHCS025075EG	1/4" x 3/4"	1.3 (0.6)
HHCS025150EG	1/4" x 1 1/2"	2.6 (1.2)
HHCS031125EG	5/16" x 1 1/4"	3.6 (1.6)
HHCS037075EG	3/8" x 3/4"	4.0 (1.8)
HHCS037087EG	3/8" x 7/8"	4.4 (2.0)
HHCS037100EG	3/8" x 1"	4.5 (2.0)
HHCS037125EG	3/8" x 1 1/4"	5.3 (2.4)
HHCS037150EG	3/8" x 1 1/2"	6.0 (2.7)
HHCS037200EG	3/8" x 2"	7.6 (3.4)
HHCS037225EG	3/8" x 2 1/4"	8.4 (3.8)
HHCS037250EG	3/8" x 2 1/2"	9.2 (4.2)
HHCS050094EG	1/2" x 1 5/16"	9.1 (4.1)
HHCS050119EG	1/2" x 1 3/16"	10.2 (4.6)
HHCS050125EG	1/2" x 1 1/4"	11.0 (5.0)
HHCS050150EG	1/2" x 1 1/2"	11.6 (5.3)
HHCS050175EG	1/2" x 1 3/4"	13.1 (5.9)
HHCS050200EG	1/2" x 2"	14.6 (6.6)
HHCS050225EG	1/2" x 2 1/4"	16 (7.3)
HHCS050250EG	1/2" x 2 1/2"	17.5 (7.9)

**HEX SLOTTED MACHINE SCREWS**



Part No.	Size	Wt/100 pcs Lbs (kg)
HSHS025050EG	1/4" x 1/2"	1.4 (0.6)
HSHS025062EG	1/4" x 5/8"	1.5 (0.7)
HSHS025075EG	1/4" x 3/4"	1.7 (0.8)
HSHS031100EG	5/16" x 1"	2.6 (1.2)
HSHS031125EG	5/16" x 1 1/4"	3.0 (1.4)
HSHS031150EG	5/16" x 1 1/2"	3.4 (1.5)
HSHS037125EG	3/8" x 1 1/4"	5.3 (2.4)

**FLAT HEAD MACHINE SCREWS**



Part No.	Size	Wt/100 pcs Lbs (kg)
HFMS025062EG	1/4" x 5/8"	1.2 (0.5)
HFMS031100EG	5/16" x 1"	2.6 (1.2)
HFMS050100EG	1/2" x 1"	9.3 (4.2)

**CONE POINT SET SCREWS**



Part No.	Size	Wt/100 pcs Lbs (kg)
HCSS025100EG	1/4" x 1"	2.8 (1.3)
HCSS031150EG	5/16" x 1 1/2"	3.9 (1.8)
HCSS037150EG	3/8" x 1 1/2"	4.5 (2.0)
HCSS037200EG	3/8" x 2"	6.1 (2.8)
HCSS050150EG	1/2" x 1 1/2"	8.5 (3.9)
HCSS050200EG	1/2" x 2"	11.4 (5.2)
HCSS062150EG	5/8" x 1 1/2"	14.5 (6.6)
HCSS062200EG	5/8" x 2"	23.0 (10.4)

**ROUND HEAD MACHINE SCREWS**



Part No.	Size	Wt/100 pcs Lbs (kg)
HRMS025050EG	1/4" x 1/2"	1 (0.5)
HRMS025075EG	1/4" x 3/4"	1.2 (0.5)
HRMS025100EG	1/4" x 1"	1.5 (0.7)
HRMS031100EG	5/16" x 1"	2.6 (1.2)
HRMS031125EG	5/16" x 1 1/4"	3.0 (1.4)
HRMS037100EG	3/8" x 1"	4.1 (1.9)
HRMS037125EG	3/8" x 1 1/4"	4.7 (2.1)
HRMS037150EG	3/8" x 1 1/2"	5.3 (2.4)

**Hardware**

**SQUARE NUTS**



Part No.	Size	Wt/100 pcs Lbs (kg)
HSQN025EG	1/4"	0.9 (0.4)
HSQN031EG	5/16"	1.6 (0.7)
HSQN037EG	3/8"	2.7 (1.2)
HSQN050EG	1/2"	5.8 (2.6)
HSQN062EG	5/8"	10.7 (4.9)
HSQN075EG	3/4"	15.4 (6.9)
HSQN087EG	7/8"	24.9 (11.3)
HSQN100EG	1"	36.3 (16.5)

**HEXAGON NUTS**



Part No.	Size	Wt/100 pcs Lbs(kg)
HHXN025EG	1/4"	0.6 (0.3)
HHXN031EG	5/16"	1.2 (0.5)
HHXN037EG	3/8"	1.6 (0.7)
HHXN050EG	1/2"	4.8 (2.2)
HHXN062EG	5/8"	7.3 (3.3)
HHXN075EG	3/4"	11.9 (5.4)
HHXN087EG	7/8"	19.0 (8.6)
HHXN100EG	1"	28.3 (12.8)

**FLAT WASHERS**



Part No.	Size	Wt/100 pcs Lbs(kg)
HFLW025EG	1/4"	0.8 (0.4)
HFLW031EG	5/16"	1.0 (0.5)
HFLW037EG	3/8"	1.5 (0.7)
HFLW050EG	1/2"	3.5 (1.6)
HFLW062EG	5/8"	7.7 (3.5)
HFLW075EG	3/4"	11.0 (5.0)
HFLW087EG	7/8"	15.3 (6.9)
HFLW100EG	1"	18.8 (8.5)

**STEEL THREADED ROD**

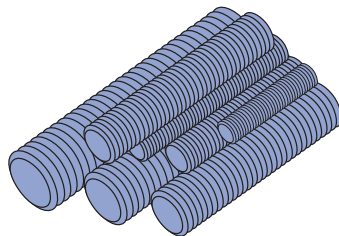

Standard Length 12' (3.7m)

Low Carbon Steel Grade 1006 - 1010  
F<sub>y</sub> = 36,000 psi minimum  
F<sub>t</sub> = 58,000 psi minimum

Part No.	Size	Wt/100 Ft. Lbs (kg)
HTHR025	1/4" x 20	13 (5.9)
HTHR031	5/16" x 18	20 (9.1)
HTHR037	3/8" x 16	30 (13.6)
HTHR044	7/16" x 14	30 (13.6)
HTHR050	1/2" x 13	53 (24.0)
HTHR062	5/8" x 11	84 (38.1)
HTHR075	3/4" x 10	124 (56.2)
HTHR087	7/8" x 9	170 (77.1)
HTHR100	1" x 8	223 (101.2)

**LOCK WASHERS**



Part No.	Size	Wt/100 pcs Lbs (kg)
HLKW025EG	1/4"	0.25 (0.1)
HLKW031EG	5/16"	0.41 (0.2)
HLKW037EG	3/8"	0.63 (0.3)
HLKW050EG	1/2"	1.32 (0.60)
HLKW062EG	5/8"	2.20 (1.0)
HLKW075EG	3/4"	3.80 (1.7)
HLKW087EG	7/8"	6.00 (2.7)
HLKW100EG	1"	8.80 (4.0)

**LOAD CARRYING CAPACITY OF THREADED HOT ROLLED STEEL  
CONFORMING TO ASTM A575 AND A576**

Threaded Rod Loads for Piping Applications (based on MSS SP-58)		
Nominal Dia.	Root Area In <sup>2</sup> (mm <sup>2</sup> )	Max. Safe Load at 650° F (343° C) Lbs (kN)
3/8"	0.068 (43.9)	730 (3.25)
1/2"	0.126 (81.3)	1,350 (6.01)
5/8"	0.202 (130.3)	2,160 (9.61)
3/4"	0.302 (194.8)	3,230 (14.37)
7/8"	0.419 (270.3)	4,480 (19.93)
1"	0.552 (356.1)	5,900 (26.24)

Threaded Rod Loads for Structural Applications (Based on AISC, Steel Construction Manual, ASD, 14th Edition. Per AISC, Allowed Tensile Stress = 0.33 * F <sub>u</sub> )		
Nominal Dia.	Nominal Area In <sup>2</sup> (mm <sup>2</sup> )	Allowed Tension Load Lbs (kN)
1/4"	0.049 (31.6)	930 (4.14)
3/8"	0.110 (71.0)	2,110 (9.39)
1/2"	0.150 (96.8)	2,870 (12.77)
3/4"	0.196 (126.5)	3,750 (16.68)
5/8"	0.307 (198.2)	5,870 (26.11)
3/4"	0.442 (285.4)	8,450 (37.59)
7/8"	0.601 (388.0)	11,500 (51.15)
1"	0.785 (506.8)	15,030 (66.86)

**STEEL COUPLER NUTS**

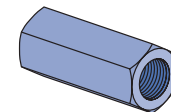

Part Number	Size	Length In (mm)	Wt/100 pcs Lbs (kg)
HRCN025	1/4" - 20	7/8" (22.2)	1.9 (0.9)
HRCN031	5/16" - 18	1 1/4" (44.5)	7.5 (3.4)
HRCN037	3/8" - 16	1 3/4" (44.5)	9.0 (4.1)
HRCN044	7/16" - 14	1 3/4" (44.5)	10.4 (4.7)
HRCN050	1/2" - 13	1 3/4" (44.5)	10.0 (4.5)
HRCN062	5/8" - 11	2 1/8" (54.0)	18.0 (8.2)
HRCN075	3/4" - 10	2 1/4" (57.2)	28.0 (12.7)
HRCN087	7/8" - 9	2 1/2" (63.5)	55.0 (24.9)
HRCN100	1" - 8	2 3/4" (69.9)	73.0 (33.1)



1 1/8" Channel

Telestrut

Nuts & Hardware

General Fittings

Pipe/Conduit Supports

Electrical Fittings

Concrete Inserts

Solar

Unipier®

**SLOT ADAPTER™**

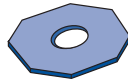
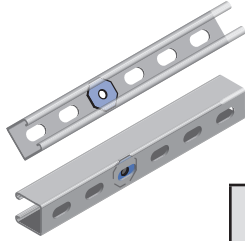

Part No.	Bolt Size	Wt/100 pcs Lbs (kg)
HOCW025	1/4" (6.4)	1 (0.5)
HOCW037	3/8" (9.5)	1.5 (0.7)

**KWIK WASHER™**

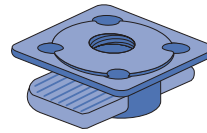

Overhead installation with one hand.  
Available in zinc plated and hot dip galvanized

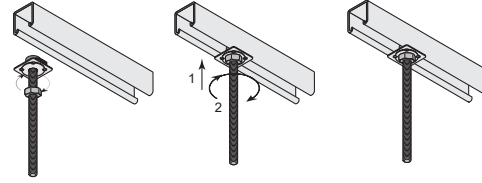

**P2486 SEISMIC ROD STIFFENER**

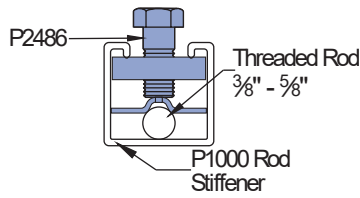
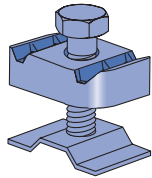

W/100 pcs: 16 Lbs (7.3 kg)

Part No.	Size In (mm)	Load Lbs (kN)	Wt/100 pcs Lbs (kg)
K1062	1/4" (6.4)	250 (1.11)	1.2 (0.5)
K1063	3/8" (9.5)	610 (2.71)	2.6 (1.2)
K1064	1/2" (12.7)	1,130 (5.03)	9.3 (4.2)

**P2485 CRADLE CLIP**

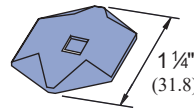

Cradle clip only, order other items separately.

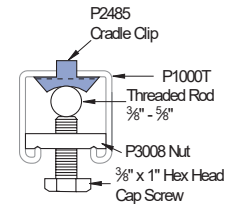

**P2485K**

**SEISMIC CRADLE CLIP ASSEMBLY**

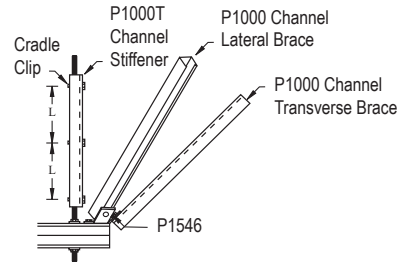
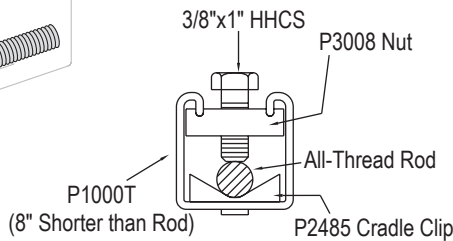
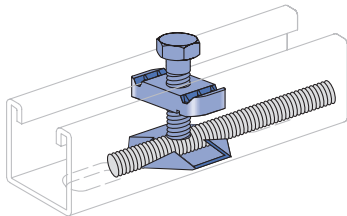

W/100 pcs: 3.0 Lbs (1.4 kg)

**P2485 & P2486 – SPACING CHART**

Rod Size In (mm)	Root Area In <sup>2</sup> (mm <sup>2</sup> )	Radius of Gyration In (mm)	Design Load Lbs (kN)	.....Rod Stiffener Clip Spacing (L).....			
				Rod Stress @100% 10,700 PSI In (mm)	Rod Stress @75% 8,025 PSI In (mm)	Rod Stress @50% 5,350 PSI In (mm)	Rod Stress @35% 3,745 PSI In (mm)
3/8	0.068	0.074	730	9	11	13	15
9.5	49.5	1.99	3.25	228.6	279.4	330.2	381.0
1/2	0.126	0.100	1,350	12	14	17	21
12.7	72.4	2.40	6.01	304.8	355.6	431.8	533.4
5/8	0.202	0.127	2,160	15	18	22	26
15.9	138.3	3.32	9.61	381.0	457.2	558.8	660.4

- Notes:
1. Minimum Tensile Stress is 50,000 psi (345MPa)
  2. Working Stress is 10,700 psi (73.9 MPa) – Same as for Tension
  3. Compression Will Only Occur During a Seismic Event
  4. Compression Requires the Use of Rod Stiffeners
  5. KL/r = 200 When Rod Stress is at 35%

Refer to seismic bracing systems catalog for more detailed information.

# GENERAL FITTINGS

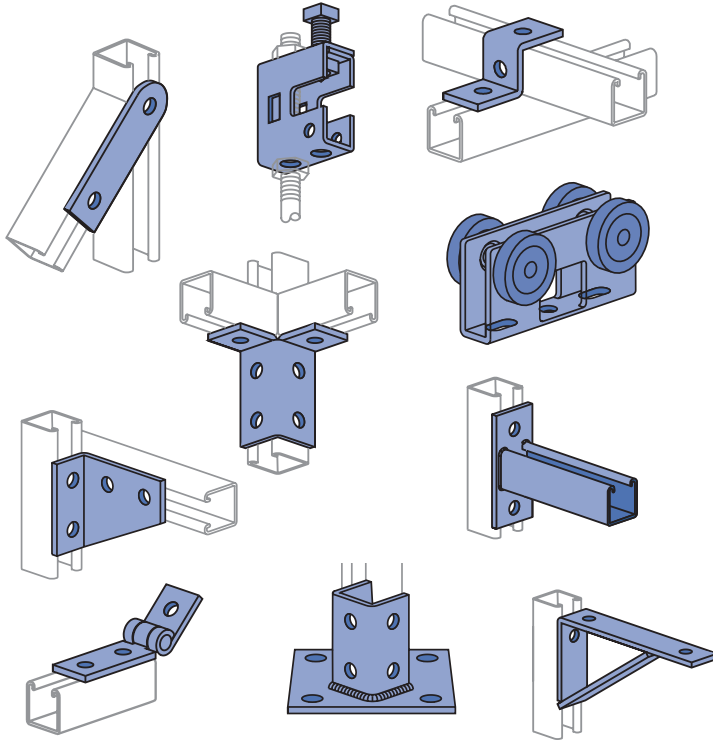

Flat Plate Fittings .....	81 - 82
Ninety Degree Fittings.....	82 - 85
Angular Fittings .....	85
"Z" Shape Fittings .....	86
"U" Shape Fittings .....	87 - 88
Wing Shape Fittings .....	89 - 90
Post Bases .....	90
Brackets .....	90 - 93
Brace Fittings.....	94
Beam Clamps.....	95 - 101
Trolleys.....	102
Special Application Fittings.....	103 - 104
Seismic Retrofit Fittings.....	104 - 106

## MATERIAL

Fittings, unless noted, are made from hot-rolled, pickled and oiled steel plates, bar, strip or coil, and conform to one or more of the following specifications: ASTM specifications A575, A576, A635, A1011 SS GR 33, A1011 HSLAS GR 45 or A36. All fittings meet or exceed physical properties of ASTM A1011 GR 33. The pickling of the steel produces a smooth surface free from scale.

Many fittings are also available in stainless steel, aluminum and fiberglass. Consult factory for ordering information.

## FINISHES

Fittings are available in:

Green Powder Coat (GR), conforming to commercial standards for Powder Coating

Electro-galvanized (EG), conforming to ASTM B633 Type III SC1;

Hot-dipped galvanized (HG), conforming to ASTM A123 or A153 and

Plain (PL)

Unistrut Defender (DF), conforming to ASTM A1059 or A1046

## APPLICATION

All parts drawings illustrate only one application of each fitting. In most cases many other applications are possible. The channels shown in the illustrations are P1000, 1 $\frac{1}{8}$ " square, except where noted otherwise.

All  $\frac{9}{16}$ " diameter holes use  $\frac{1}{2}$ " x  $\frac{15}{16}$ " hex head cap screws and  $\frac{1}{2}$ " nuts – P1010, P3010, P4010 or P5510 – depending on the channel used. Nuts and bolts are not included with the fitting and must be ordered separately.

## DESIGN BOLT TORQUE

BOLT SIZE	$\frac{1}{4}$ "-20	$\frac{5}{16}$ "-18	$\frac{3}{8}$ "-16	$\frac{1}{2}$ "-13	$\frac{5}{8}$ "-11	$\frac{3}{4}$ "-10
Rec. Torque Ft/Lbs (N•m)	6 (8)	11 (15)	19 (26)	50 (68)	100 (136)	125 (170)
Max Torque Ft/Lbs (N•m)	7 (9)	15 (20)	25 (34)	70 (95)	125 (170)	135 (183)

## SET SCREW TORQUE

BOLT SIZE	$\frac{1}{4}$ "-20	$\frac{3}{8}$ "-16	$\frac{1}{2}$ "-13	$\frac{5}{8}$ "-11	$\frac{3}{4}$ "-10	$\frac{7}{8}$ "-9
Set Screw Torque In/Lbs (N•m)	40 (4)	60 (7)	125 (14)	250 (28)	400 (44.5)	665 (75)

Note: Caution should be taken not to overtighten the set screw

## DIMENSIONS

Imperial dimensions are illustrated in inches. Metric dimensions are shown in parenthesis or as noted. Unless noted, all metric dimensions are in millimeters and rounded to one decimal place.

## DESIGN LOAD

Design load data, where shown, is based on the ultimate strength of the connection with a safety factor of 2.5, unless otherwise noted.

## BEAM CLAMPS

Clamps are designed to be used with W, M, S and HP Shape beams, Standard C and Miscellaneous MC Channels, Angles and Structural Tees. Clamps must be used in pairs mounted in opposite directions where indicated. For beam clamps with HG finish, standard hardware is EG finish. For optional stainless steel hardware, please contact the factory for availability.



1 1/8" Channel

Telestrut

Nuts & Hardware

General Fittings

Pipe/Conduit Supports

Electrical Fittings

Concrete Inserts

Solar

Unipier®

**Flat Plate Fittings**

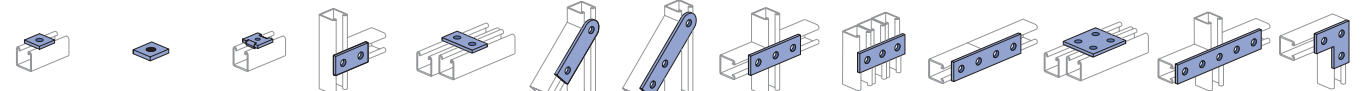

P1062-Pg 81 P1959-Pg 81 P2862-Pg 81 P1065-Pg 81 P1924-Pg 81 P2325-Pg 81 P2324-Pg 81 P1066-Pg 81 P1925-Pg 81 P1067-Pg 81 P2079-Pg 81 P1941-Pg 81 P1036-Pg 81

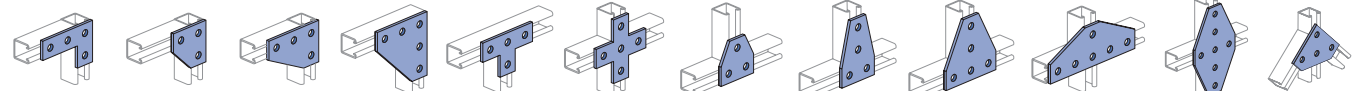

P1380 A-Pg 81 P1334-Pg 81 P1380-Pg 81 P1873-Pg 82 P1031-Pg 82 P1028-Pg 82 P1356-Pg 82 P1358-Pg 82 P1726-Pg 82 P1953-Pg 82 P1950-Pg 82 P1962-Pg 82

**Angle Fittings**

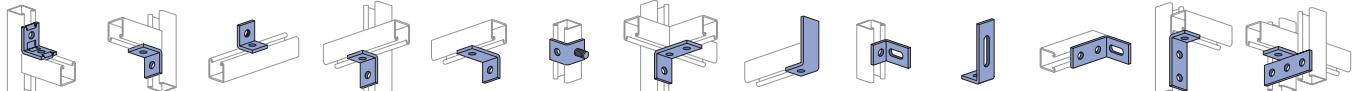

P2626-Pg 82 P1026-Pg 82 P1723-Pg 82 P1068-Pg 82 P1281-Pg 82 P1315-Pg 82 P1458-Pg 82 P1538A-Pg 83 P1750-Pg 83 P1498-Pg 83 P1747-Pg 83 P1326-Pg 83 P1821-Pg 83

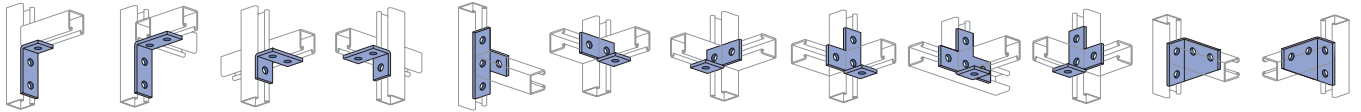

P1346-Pg 83 P1325-Pg 83 P1822-Pg 83 P1823-Pg 83 P1033-Pg 83 P1037-Pg 83 P1038-Pg 83 P1034-Pg 83 P1029-Pg 84 P1035-Pg 84 P1290-Pg 84 P1291-Pg 84

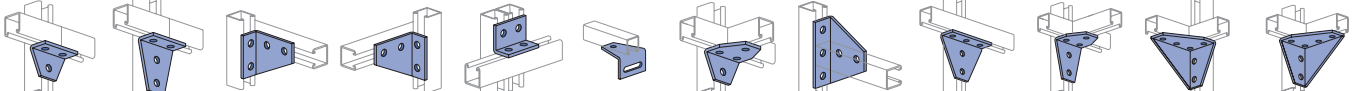

P1357-Pg 84 P1359-Pg 84 P1381-Pg 84 P1382-Pg 84 P1934-Pg 84 P1713-Pg 84 P1579-Pg 84 P1727-Pg 84 P1728-Pg 84 P2235-Pg 84 P1956-Pg 84 P1957-Pg 84

**"Z" Shape Fittings**

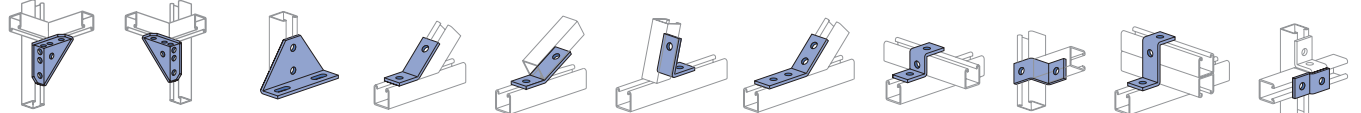

P2484-Pg 85 P2484W-Pg 85 P1130-Pg 85 P1546-Pg 85 P2101-Pg 85 P1186-Pg 85 P2260-Pg 85 P1045-Pg 86 P1347-Pg 86 P1453-Pg 86 P1454-Pg 86

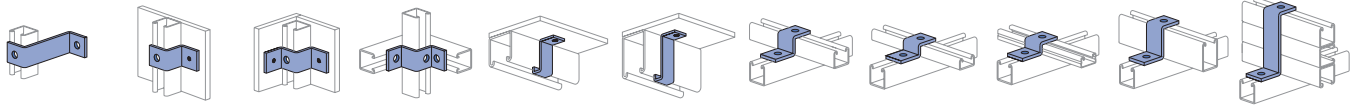

P1479A-Pg 86 P1730-Pg 86 P1734-Pg 86 P1736-Pg 86 P2360-Pg 86 P5560-Pg 86 P3045-Pg 86 P3345, P612-Pg 86 P4045-Pg 86 P5545-Pg 86 P2469-Pg 86

**"U" Shape Fittings**

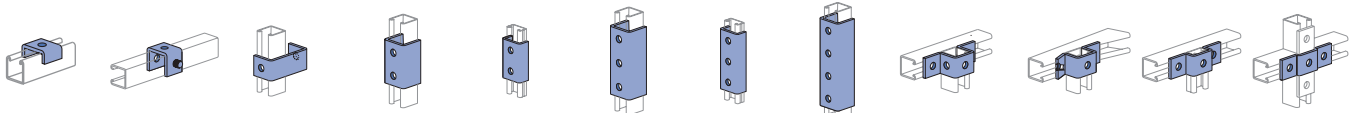

P2800-Pg 87 P1320-Pg 87 P1363A-Pg 87 P1376-Pg 87 P4376-Pg 87 P1376A-Pg 87 P4376A-Pg 87 P1377-Pg 87 P1047-Pg 87 P3047, P976-Pg 87 P4047-Pg 87 P1455-Pg 87

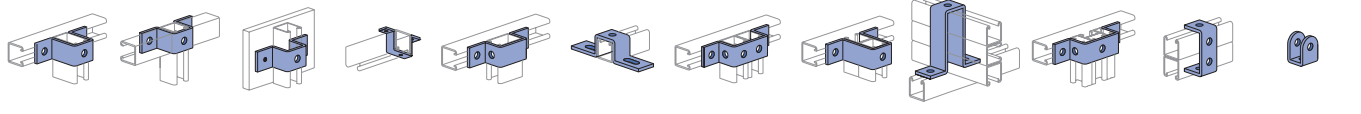

P5547-Pg 87 P1383-Pg 88 P1732-Pg 88 P2237-Pg 88 P5543-Pg 88 P1048-Pg 88 P1043A-Pg 88 P1737-Pg 88 P2473-Pg 88 P4043-Pg 88 P1044-Pg 88 P1973-Pg 88



P2326-Pg 88 P2328-Pg 88 P2329-Pg 88

**General Fittings Pictorial Index**

1 1/8" Channel  
Telestrut  
Nuts & Hardware  
General Fittings  
Pipe/Conduit Supports  
Electrical Fittings  
Concrete Inserts  
Solar  
Unipier®

**Wing Shape Fittings**

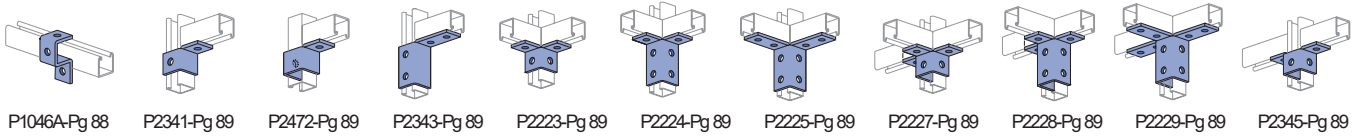

**Post Bases**



**Brackets and Brace Fittings**

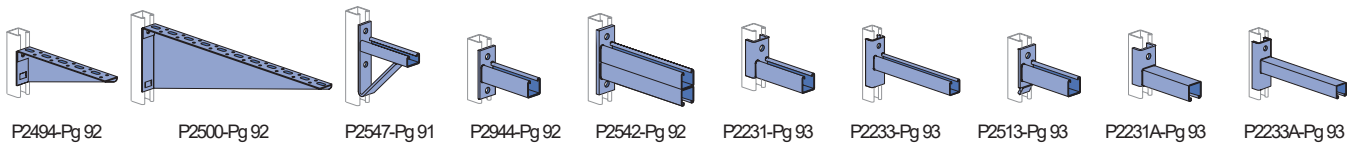
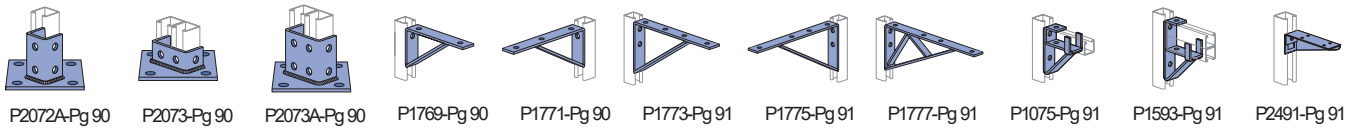

**Beam Clamps**

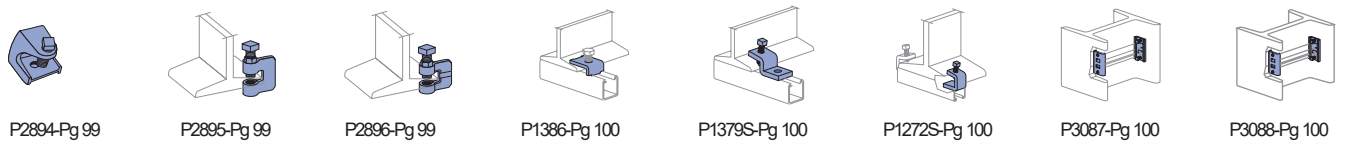
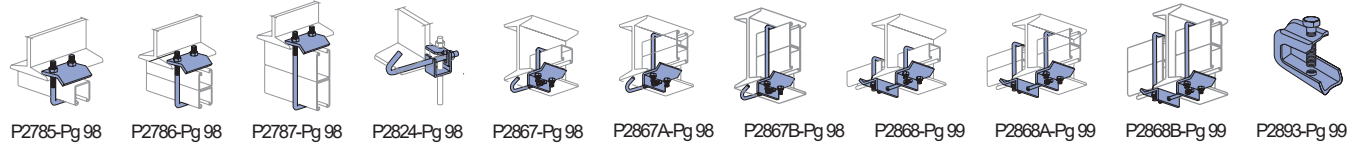
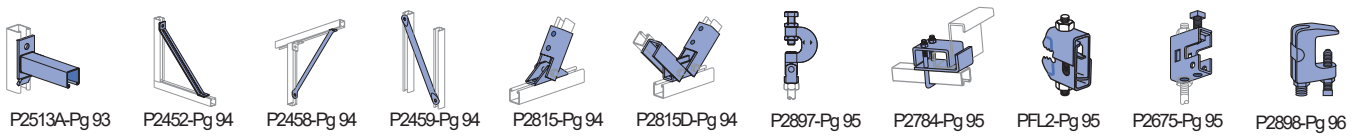

**Trolley Assemblies**

**Special Applications Fittings**

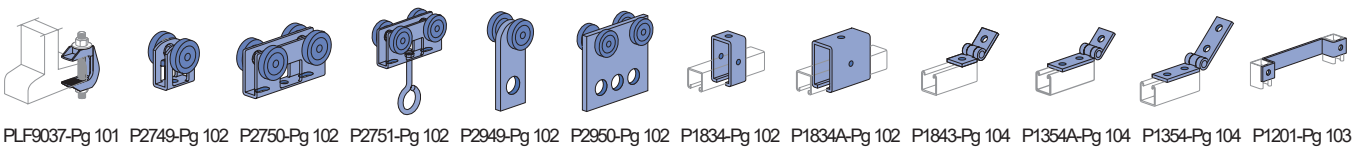

**Seismic Retrofit Fittings**

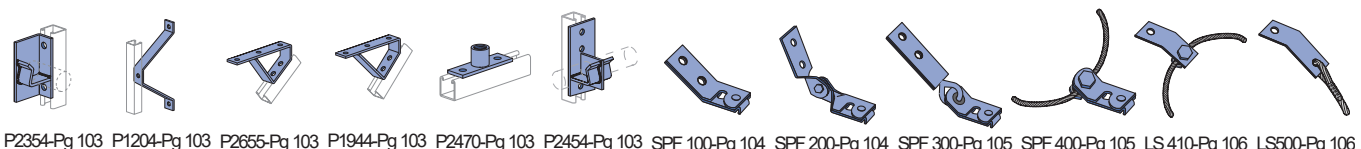



**DESIGN LOAD DATA FOR TYPICAL UNISTRUT CHANNEL CONNECTIONS**

90° Fittings (When used in position shown)

1 1/8" Channel

Telestrut

Nuts & Hardware

General Fittings

Pipe/Conduit Supports

Electrical Fittings

Concrete Inserts

Solar

Unipier®

		Channel Thickness		
Load – P1026		12 ga.	14 ga.	16 ga.
	Lbs	1,500	1,000	750
	kN	6.67	4.45	3.34

		Channel Thickness		
Load – P2484		12 ga.	14 ga.	16 ga.
	Lbs	3,000	2,000	1,500
	kN	13.34	8.90	6.67

		Channel Thickness		
Load – P1026		12 ga.	14 ga.	16 ga.
	Lbs	1,000	650	500
	kN	4.45	2.89	2.22

		Channel Thickness		
Load – P1068		12 ga.	14 ga.	16 ga.
	Lbs	500	500	500
	kN	2.22	2.22	2.22

		Channel Thickness		
Load – P1325, P2235		12 ga.	14 ga.	16 ga.
	Lbs	2,000	2,000	1,500
	kN	8.90	8.90	6.67

		Channel Thickness		
Load – P1326		12 ga.	14 ga.	16 ga.
	Lbs	500	500	500
	kN	2.22	2.22	2.22

		Channel Thickness		
Load – P1458, P1579		12 ga.	14 ga.	16 ga.
	Lbs	1,500	1,000	1,000
	kN	6.67	4.45	4.45

		Channel Thickness		
Load – P1346		12 ga.	14 ga.	16 ga.
	Lbs	1,200	1,200	1,000
	kN	5.34	5.34	4.45

		Channel Thickness		
Load – P1346		12 ga.	14 ga.	16 ga.
	Lbs	2,000	1,500	900
	kN	8.90	6.67	4.00

		Channel Thickness		
Load – P1065		12 ga.	14 ga.	16 ga.
	Lbs	1,000	800	600
	kN	4.45	3.56	2.67

- Note:
- (1) Both ends of beams supported.
  - (2) Load data is based on P1010 nut and 1/2" bolt.
  - (3) Safety factor = 2 1/2 based on ultimate strength of connection.



**Flat Plate Fittings**

**P1062, P1063, P1064, P1964, P2471, P2490** DF, EG, GR, HG

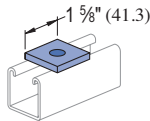

Part No.	Bolt Size	Hole Size	W/100 pcs Lbs (kg)
P1062	5/16"	1 1/32"	18 (8.2)
P1063	3/8"	7/16"	18 (8.2)
P1064	1/2"	9/16"	17 (7.7)
P1964	5/8"	1 1/16"	16 (7.3)
P2471	3/4"	1 3/16"	15 (6.8)
P2490	7/8"	1 5/16"	14 (6.4)

**P1959, P1960, P1961** EG, GR, HG

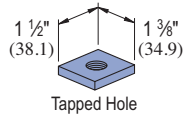

Part Number	U.S. Std. Thd Size	W/100 pcs Lbs (kg)
P1959	3/8" - 16	21 (9.5)
P1960	1/2" - 13	20 (9.1)
P1961	5/8" - 11	19 (8.6)

Material: 3/8" (9.5 mm) thick

**P2862, 2863, 2864** DF, EG, GR, HG

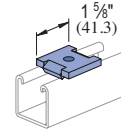

Part Number	Bolt Size	Hole Size	W/100 pcs Lbs (kg)
P2862	5/16"	1 1/32"	18 (8.2)
P2863	3/8"	7/16"	18 (8.2)
P2864	1/2"	9/16"	17 (7.7)

**P1065** DF, EG, GR, HG

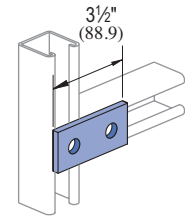

W/100 pcs: 38 Lbs (17.2 kg)

**P1924** EG, GR, HG

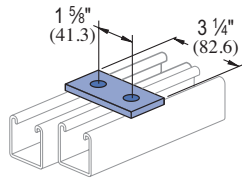

W/100 pcs: 35 Lbs (15.9 kg)

**P2325** EG, GR, HG

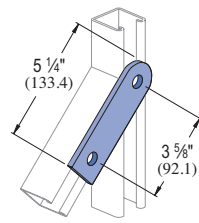

W/100 pcs: 55 Lbs (24.9 kg)

**P2324** DF, EG, GR, HG

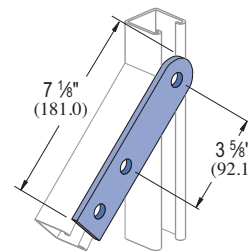

W/100 pcs: 75 Lbs (34.0 kg)

**P1066** DF, EG, GR, HG

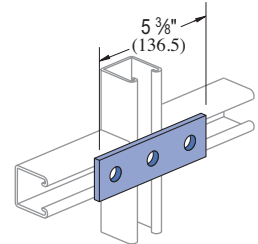

W/100 pcs: 56 Lbs (25.4 kg)

**P1925** EG, GR, HG

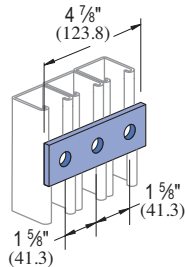

W/100 pcs: 50 Lbs (22.7 kg)

**P1067** EG, GR, HG

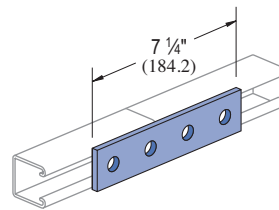

W/100 pcs: 78 Lbs (35.4 kg)

**P2079** EG, GR, HG

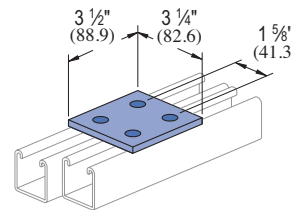

W/100 pcs: 73 Lbs (33.1 kg)

**P1941** EG, GR, HG

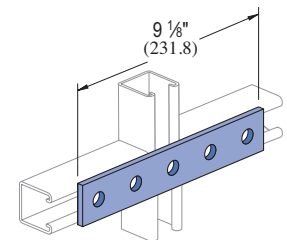

W/100 pcs: 94 Lbs (42.6 kg)

**P1036** DF, EG, GR, HG

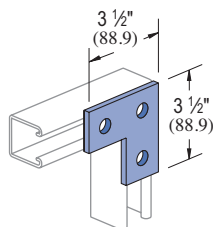

W/100 pcs: 58 Lbs (26.3 kg)

**P1380 A** DF, EG, GR, HG

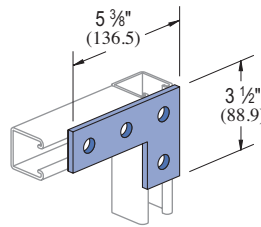

W/100 pcs: 80 Lbs (36.3 kg)

**P1334** EG, GR, HG

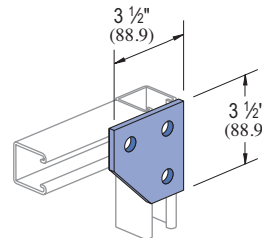

W/100 pcs: 70 Lbs (31.8 kg)

**P1380** EG, GR, HG

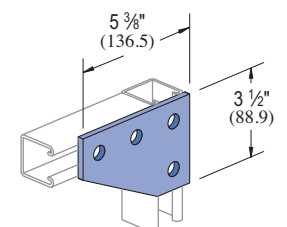

W/100 pcs: 105 Lbs (47.6 kg)

Standard Dimensions for 1 5/8" (41.3mm) width series channel fittings (Unless Otherwise Shown on Drawing)

Hole Diameter: 5/16" (14.3mm); Hole Spacing - From End: 1 5/16" (20.6mm); Hole Spacing - On Center: 1 5/8" (47.6mm); Width: 1 5/8" (41.3mm); Thickness: 1/4" (6.4mm) with steel meeting or exceeding ASTM A1011 SS GR 33, or 0.220" (5.6mm) with steel meeting or exceeding ASTM A1011 HSLAS GR 45



1 1/8" Channel

Telestrut

Nuts & Hardware

General Fittings

Pipe/Conduit Supports

Electrical Fittings

Concrete Inserts

Solar

Unipier®

**P1873** EG, GR, HG

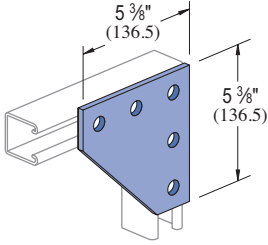

Wt/100 pcs: 150 Lbs (68.0 kg)

**P1031** DF, EG, GR, HG

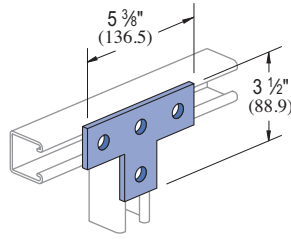

Wt/100 pcs: 80 Lbs (36.3 kg)

**P1028** DF, EG, GR, HG

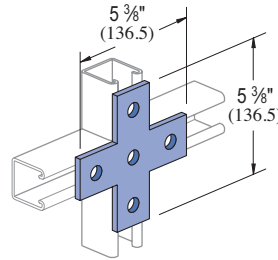

Wt/100 pcs: 105 Lbs (47.6 kg)

**P1356** EG, GR, HG

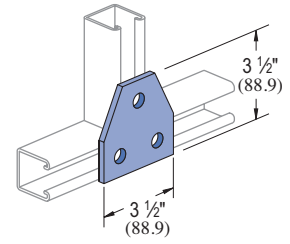

Wt/100 pcs: 70 Lbs (31.8 kg)

**P1358** EG, GR, HG

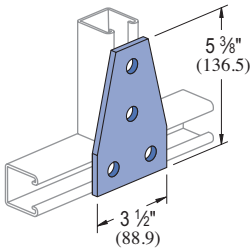

Wt/100 pcs: 105 Lbs (47.6 kg)

**P1726** EG, GR, HG

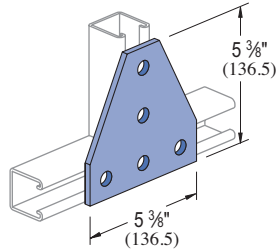

Wt/100 pcs: 148 Lbs (67.1 kg)

**P1953** EG, GR, HG

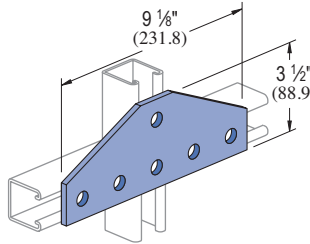

Wt/100 pcs: 176 Lbs (79.8 kg)

**P1950** EG, GR, HG

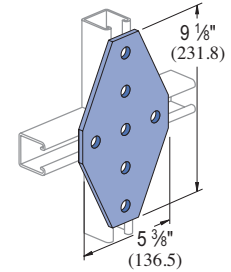

Wt/100 pcs: 240 Lbs (108.9 kg)

**P1962** EG, GR, HG

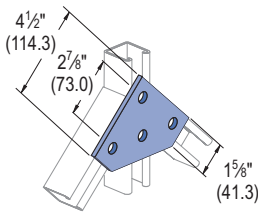

Wt/100 pcs: 112 Lbs (50.8 kg)

**P2626** EG, GR, HG

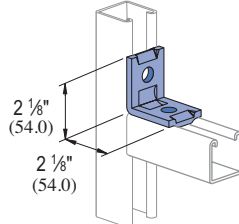

Wt/100 pcs: 40 Lbs (18.1 kg)

**P1026** DF, EG, GR, HG

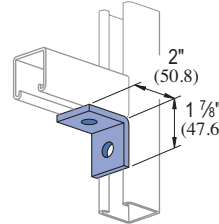

Wt/100 pcs: 38 Lbs (17.2 kg)

**P1723** EG, GR, HG

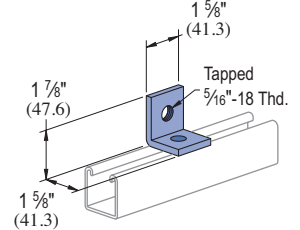

Wt/100 pcs: 34 Lbs (15.4 kg)

**P1068** DF, EG, GR, HG

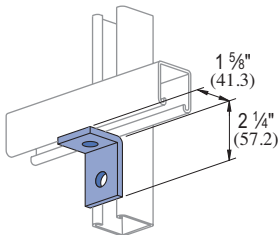

Wt/100 pcs: 38 Lbs (17.2 kg)

**P1281, P1282, P1283** EG, GR, HG

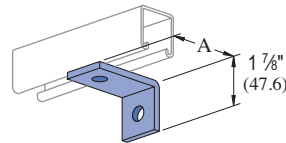

Part No.	"A" In (mm)	Wt/100 pcs Lbs (kg)
P1281	3	49
P1282	3 1/2	54
P1283	4	61
	101.6	27.7

**P1315** EG, GR, HG

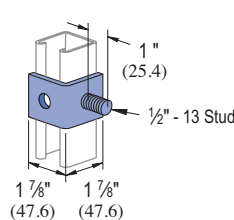

Wt/100 pcs: 45 Lbs (20.4 kg)

**P1458** EG, GR, HG

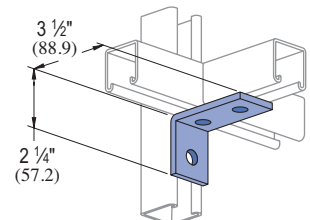

Wt/100 pcs: 58 Lbs (26.3 kg)

Standard Dimensions for 1 1/8" (41.3mm) width series channel fittings (Unless Otherwise Shown on Drawing)

Hole Diameter: 9/16" (14.3mm); Hole Spacing - From End: 1/16" (20.6mm); Hole Spacing - On Center: 1 1/8" (47.6mm); Width: 1 5/8" (41.3mm); Thickness: 1/4" (6.4mm) with steel meeting or exceeding ASTM A1011 SS GR 33, or 0.220" (5.6mm) with steel meeting or exceeding ASTM A1011 HSLAS GR 45

**Ninety Degree Angle Fittings**

**P1538A THRU P1538D**

EG, GR, HG

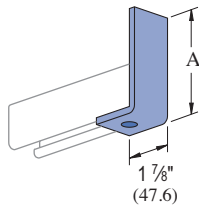

Part Number	"A" In (mm)	Wt/100 pcs Lbs (kg)
P1538A	3/8 98.4	61 27.7
P1538B	5/8 149.2	84 38.1
P1538C	7/8 200.0	107 48.5
P1538D	9/8 250.8	130 59.0

**P1498, P1499**

DF, EG, GR, HG

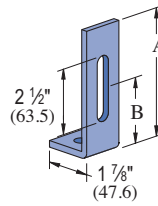

Part Number	"A" In (mm)	"B" In (mm)	Wt/100 pcs Lbs (kg)
P1498	4/8 123.8	2 1/2 63.5	65 29.5
P1499	6/8 174.6	4 1/2 114.3	85 38.6

**P1750**

EG, GR, HG

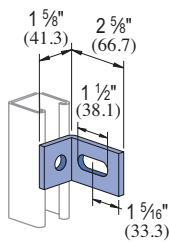

Wt/100 pcs: 38 Lbs (17.2 kg)

**P1747**

EG, GR, HG

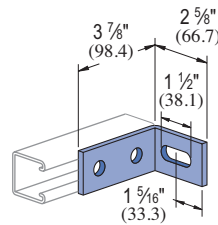

Wt/100 pcs: 66 Lbs (29.9 kg)

**P1326**

EG, GR, HG

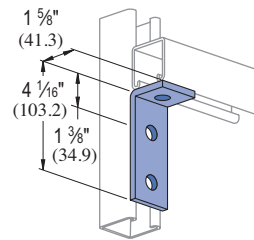

Wt/100 pcs: 58 Lbs (26.3 kg)

**P1821**

EG, GR, HG

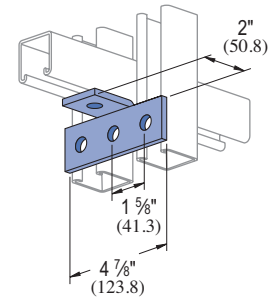

Wt/100 pcs: 71 Lbs (32.2 kg)

**P1346**

EG, GR, HG

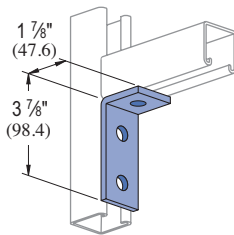

Wt/100 pcs: 58 Lbs (26.3 kg)

**P1325**

EG, GR, HG

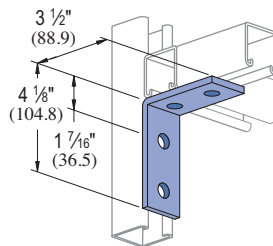

Wt/100 pcs: 78 Lbs (35.4 kg)

**P1822**

EG, GR, HG

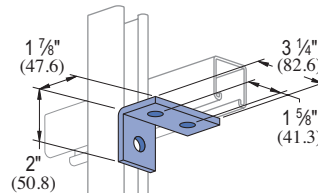

Wt/100 pcs: 55 Lbs (24.9 kg)

**P1823**

EG, GR, HG

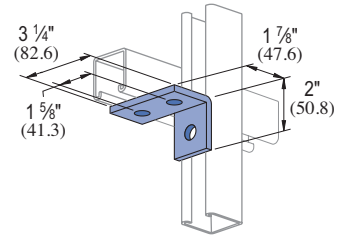

Wt/100 pcs: 55 Lbs (24.9 kg)

**P1033**

EG, GR, HG

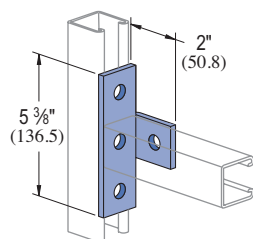

Wt/100 pcs: 80 Lbs (36.3 kg)

**P1037**

EG, GR, HG

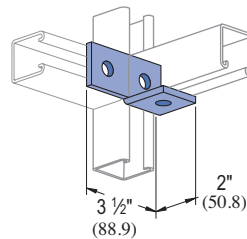

Wt/100 pcs: 58 Lbs (26.3 kg)

**P1038**

EG, GR, HG

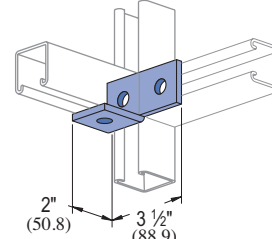

Wt/100 pcs: 58 Lbs (26.3 kg)

**P1034**

EG, GR, HG

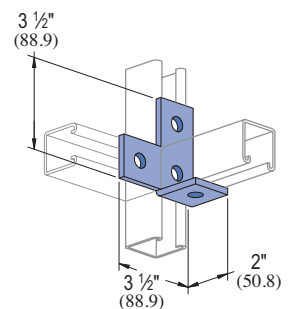

Wt/100 pcs: 80 Lbs (36.3 kg)

Standard Dimensions for 1 5/8" (41.3mm) width series channel fittings (Unless Otherwise Shown on Drawing)

Hole Diameter: 5/16" (14.3mm); Hole Spacing - From End: 1 3/16" (20.6mm); Hole Spacing - On Center: 1 7/8" (47.6mm); Width: 1 5/8" (41.3mm); Thickness: 1/4" (6.4mm) with steel meeting or exceeding ASTM A1011 SS GR 33, or 0.220" (5.6mm) with steel meeting or exceeding ASTM A1011 HSLAS GR 45



1 1/8" Channel

Telestrut

Nuts & Hardware

General Fittings

Pipe/Conduit Supports

Electrical Fittings

Concrete Inserts

Solar

Unipier®

**P1029** EG, GR, HG

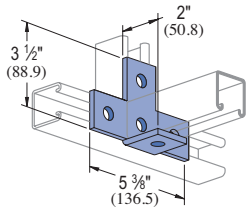

WW/100 pcs: 105 Lbs (47.6 kg)

**P1035** EG, GR, HG

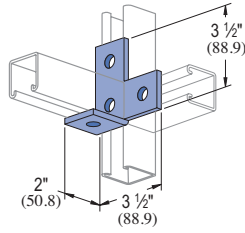

WW/100 pcs: 80 Lbs (36.3 kg)

**P1290** EG, GR, HG

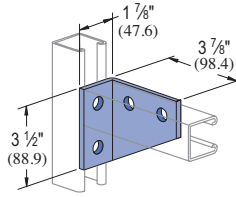

WW/100 pcs: 101 Lbs (45.8 kg)

**P1291** EG, GR, HG

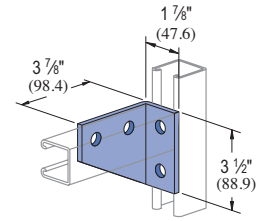

WW/100 pcs: 101 Lbs (45.8 kg)

**P1357** EG, GR, HG

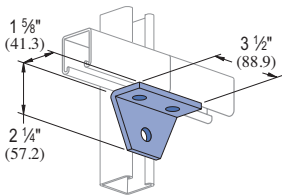

WW/100 pcs: 70 Lbs (31.8 kg)

**P1359** EG, GR, HG

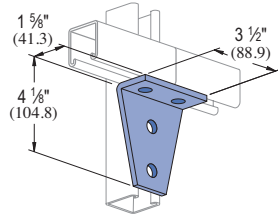

WW/100 pcs: 105 Lbs (47.6 kg)

**P1381** EG, GR, HG

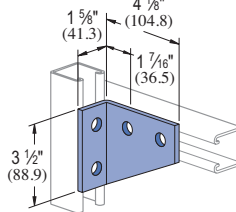

WW/100 pcs: 105 Lbs (47.6 kg)

**P1382** EG, GR, HG

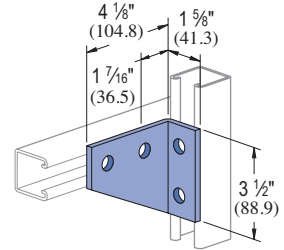

WW/100 pcs: 105 Lbs (47.6 kg)

**P1934**

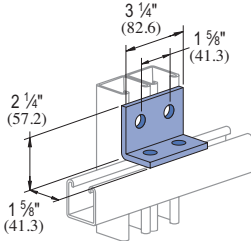

WW/100 pcs: 75 Lbs (34.0 kg)

**P1713**

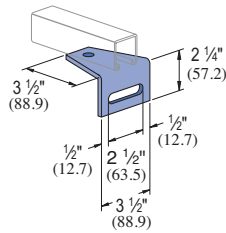

WW/100 pcs: 97 Lbs (44.0 kg)

**P1579**

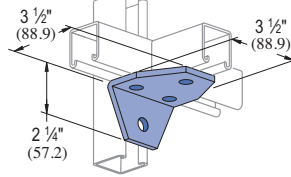

WW/100 pcs: 103 Lbs (46.7 kg)

**P1727**

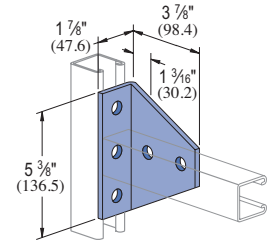

WW/100 pcs: 154 Lbs (69.9 kg)

**P1728**

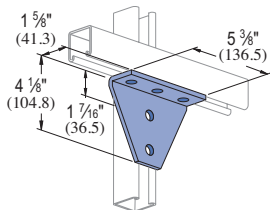

WW/100 pcs: 154 Lbs (69.9 kg)

**P2235**

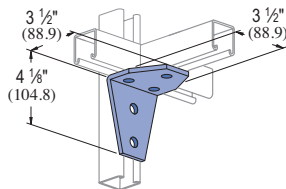

WW/100 pcs: 135 Lbs (61.2 kg)

**P1956**

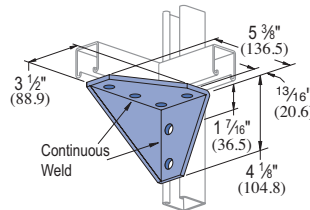

WW/100 pcs: 230 Lbs (104.3 kg)

**P1957** EG, GR, HG

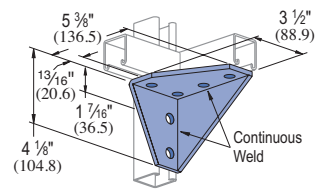

WW/100 pcs: 230 Lbs (104.3 kg)

Standard Dimensions for 1 1/8" (41.3mm) width series channel fittings (Unless Otherwise Shown on Drawing)

Hole Diameter: 9/16" (14.3mm); Hole Spacing - From End: 1 5/8" (20.6mm); Hole Spacing - On Center: 1 7/8" (47.6mm); Width: 1 5/8" (41.3mm); Thickness: 1/4" (6.4mm) with steel meeting or exceeding ASTM A1011 SS GR 33, or 0.220" (5.6mm) with steel meeting or exceeding ASTM A1011 HSLAS GR 45

**Ninety Degree Angle & Angular Fittings**

**P2484** [DF, EG, GR, HG]

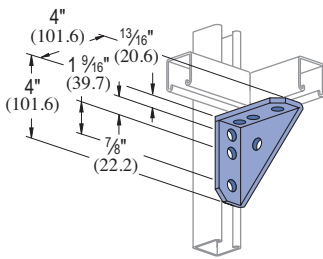

W/100 pcs: 134 Lbs (60.8 kg)

**P2484W** [EG, GR, HG]

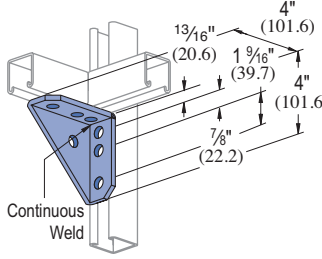

W/100 pcs: 134 Lbs (60.8 kg)

**P1130, P1131** [EG, GR, HG]

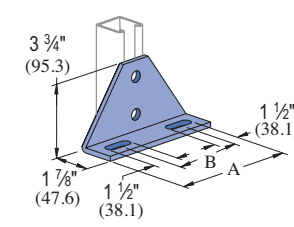

Part Number	"A" In (mm)	"B" In (mm)	W/100 pcs Lbs (kg)
P1130	6 <sup>5</sup> / <sub>16</sub> 168.3	4 101.6	190 86.2
P1131	8 <sup>5</sup> / <sub>16</sub> 219.1	6 152.4	242 109.8

**P1546, P2094 THRU P2100** [DF, EG, GR, HG]

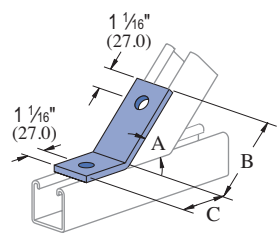

Part No.	"A" Degree (rad)	"B" In (mm)	"C" In (mm)
P2094	82 <sup>1</sup> / <sub>2</sub> ° 1.44	3 <sup>9</sup> / <sub>16</sub> 90.5	1 <sup>1</sup> / <sub>16</sub> 42.9
P2095	75° 1.31	3 <sup>9</sup> / <sub>16</sub> 90.5	1 <sup>1</sup> / <sub>16</sub> 42.9
P2096	67 <sup>1</sup> / <sub>2</sub> ° 1.18	3 <sup>1</sup> / <sub>2</sub> 88.9	1 <sup>3</sup> / <sub>4</sub> 44.5
P2097	60° 1.05	3 <sup>3</sup> / <sub>8</sub> 85.7	1 <sup>1</sup> / <sub>8</sub> 47.6
P2098	52 <sup>1</sup> / <sub>2</sub> ° 0.92	3 <sup>1</sup> / <sub>4</sub> 82.6	2 <sup>1</sup> / <sub>16</sub> 52.4
P1546	45° 0.79	3 76.2	2 <sup>9</sup> / <sub>16</sub> 58.7
P2099	37 <sup>1</sup> / <sub>2</sub> ° 0.65	3 <sup>1</sup> / <sub>2</sub> 88.9	1 <sup>3</sup> / <sub>16</sub> 46.0
P2100	37 <sup>1</sup> / <sub>2</sub> ° 0.65	2 <sup>1</sup> / <sub>16</sub> 68.3	2 <sup>5</sup> / <sub>8</sub> 66.7

W/100 pcs: 58 Lbs (26.3 kg)

**P2101 THRU P2104** [EG, GR, HG]

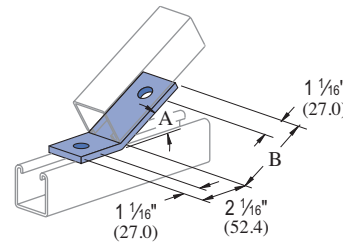

Part No.	"A" Degree (rad)	"B" In (mm)
P2101	30° 0.52	3 <sup>1</sup> / <sub>4</sub> 82.6
P2102	22 <sup>1</sup> / <sub>2</sub> ° 0.39	3 <sup>3</sup> / <sub>16</sub> 84.1
P2103	15° 0.26	3 <sup>5</sup> / <sub>16</sub> 84.1
P2104	7 <sup>1</sup> / <sub>2</sub> ° 0.13	3 <sup>3</sup> / <sub>16</sub> 84.1

W/100 pcs: 58 Lbs (26.3 kg)

**P1186, P2105 THRU P2110** [DF, EG, GR, HG]

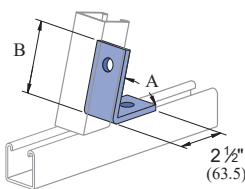

Part Number	"A" Degree (rad)	"B" In (mm)
P2105	82 <sup>1</sup> / <sub>2</sub> ° 1.44	3 <sup>1</sup> / <sub>4</sub> 82.6
P2106	75° 1.31	3 <sup>1</sup> / <sub>4</sub> 82.6
P2107	67 <sup>1</sup> / <sub>2</sub> ° 1.18	3 <sup>9</sup> / <sub>16</sub> 81.0
P2108	60° 1.05	3 <sup>3</sup> / <sub>8</sub> 81.0
P2109	52 <sup>1</sup> / <sub>2</sub> ° 0.92	3 <sup>1</sup> / <sub>2</sub> 79.4
P1186	45° 0.79	3 <sup>1</sup> / <sub>8</sub> 79.4
P2110	37 <sup>1</sup> / <sub>2</sub> ° 0.65	3 <sup>1</sup> / <sub>16</sub> 77.8

W/100 pcs: 58 Lbs (26.3 kg)

**P2260 THRU P2270** [DF, EG, GR, HG]

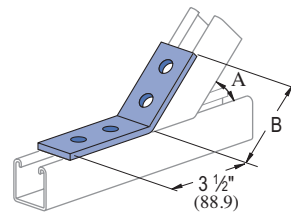

Part Number	"A" Degree (rad)	"B" In (mm)
P2270	82 <sup>1</sup> / <sub>2</sub> ° 1.44	3 <sup>5</sup> / <sub>8</sub> 92.1
P2269	75° 1.31	3 <sup>3</sup> / <sub>8</sub> 92.1
P2268	67 <sup>1</sup> / <sub>2</sub> ° 1.18	3 <sup>5</sup> / <sub>8</sub> 92.1
P2267	60° 1.05	3 <sup>1</sup> / <sub>16</sub> 93.7
P2266	52 <sup>1</sup> / <sub>2</sub> ° 0.92	3 <sup>1</sup> / <sub>16</sub> 93.7
P2265	45° 0.79	3 <sup>1</sup> / <sub>16</sub> 93.7
P2264	37 <sup>1</sup> / <sub>2</sub> ° 0.65	3 <sup>1</sup> / <sub>16</sub> 93.7
P2263	30° 0.52	3 <sup>1</sup> / <sub>16</sub> 93.7
P2262	22 <sup>1</sup> / <sub>2</sub> ° 0.39	3 <sup>3</sup> / <sub>4</sub> 95.3
P2261	15° 0.26	3 <sup>3</sup> / <sub>4</sub> 95.3
P2260	7 <sup>1</sup> / <sub>2</sub> ° 0.13	3 <sup>3</sup> / <sub>4</sub> 95.3

W/100 pcs: 78 Lbs (35.4 kg)

Standard Dimensions for 1<sup>1</sup>/<sub>8</sub>" (41.3mm) width series channel fittings (Unless Otherwise Shown on Drawing)  
 Hole Diameter: 9<sup>1</sup>/<sub>16</sub>" (14.3mm); Hole Spacing - From End: 1<sup>3</sup>/<sub>16</sub>" (20.6mm); Hole Spacing - On Center: 1<sup>7</sup>/<sub>8</sub>" (47.6mm); Width: 1<sup>1</sup>/<sub>8</sub>" (41.3mm); Thickness: 1<sup>1</sup>/<sub>4</sub>" (6.4mm) with steel meeting or exceeding ASTMA1011 SS GR 33, or 0.220" (5.6mm) with steel meeting or exceeding ASTMA1011 HSLAS GR 45



1 1/8" Channel

Telestrut

Nuts & Hardware

General Fittings

Pipe/Conduit Supports

Electrical Fittings

Concrete Inserts

Solar

Unipier®

**P1045** DF, EG, GR, HG

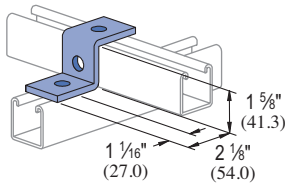

Wt/100 pcs: 55 Lbs (24.9 kg)

**P1347** EG, GR, HG

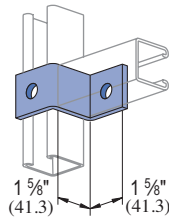

Wt/100 pcs: 55 Lbs (24.9 kg)

**P1453** EG, GR, HG

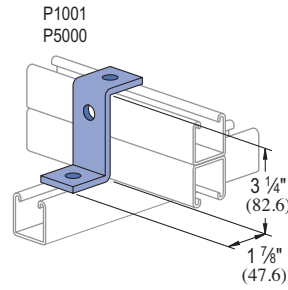

Wt/100 pcs: 70 Lbs (31.8 kg)

**P1454** EG, GR, HG

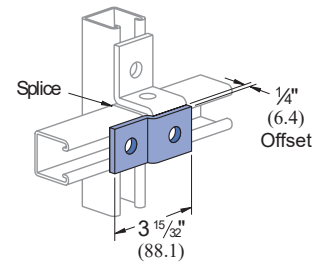

Wt/100 pcs: 38 Lbs (17.2 kg)

**P1479A THRU P1479E**

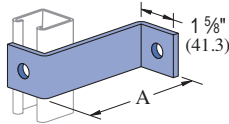

Part Number	"A" In (mm)	Wt/100 pcs Lbs (kg)
P1479A	4 (101.6)	81 (36.7)
P1479B	5 (127.0)	92 (41.7)
P1479C	6 (152.4)	104 (47.2)
P1479D	7 (177.8)	115 (52.2)
P1479E	8 (203.2)	127 (57.6)

**P1730**

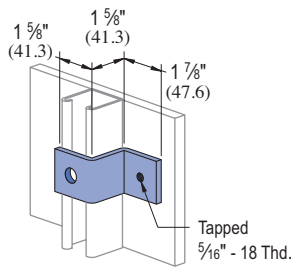

Wt/100 pcs: 54 Lbs (24.5 kg)

**P1734**

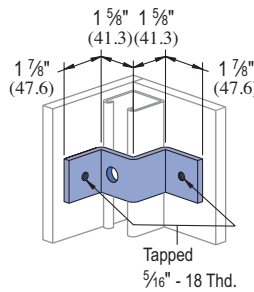

Wt/100 pcs: 70 Lbs (31.8 kg)

**P1736**

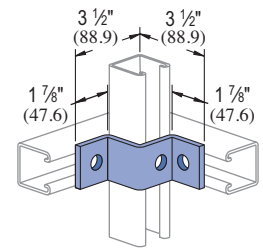

Wt/100 pcs: 70 Lbs (31.8 kg)

**P2360**

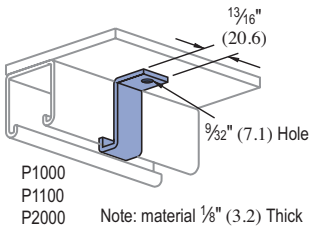

Wt/100 pcs: 9 Lbs (4.1 kg)

**P5560**

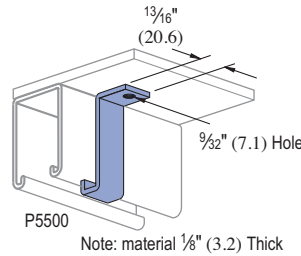

Wt/100 pcs: 11 Lbs (5.0 kg)

**P3045** EG, GR, HG

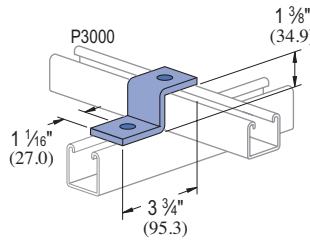

Wt/100 pcs: 53 Lbs (24.0 kg)

**P612** EG, GR, HG

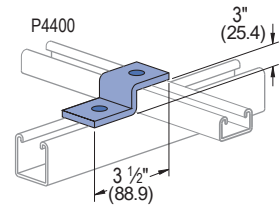

Wt/100 pcs: 47 Lbs (21.3 kg)

**P3345** EG, GR, HG

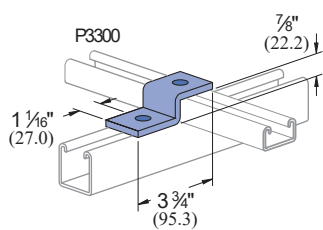

Wt/100 pcs: 47 Lbs (21.3 kg)

**P4045** EG, GR, HG

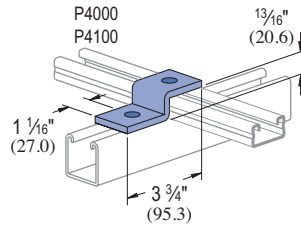

Wt/100 pcs: 47 Lbs (21.3 kg)

**P5545** EG, GR, HG

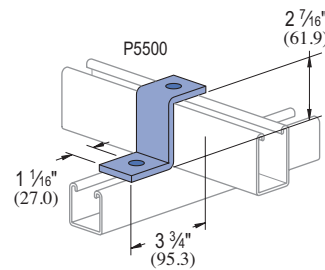

Wt/100 pcs: 67 Lbs (30.4 kg)

**P2469**

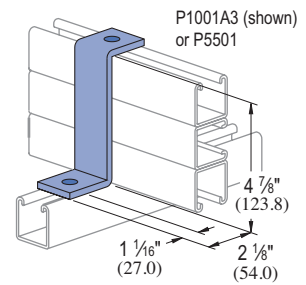

Wt/100 pcs: 93 Lbs (42.2 kg)

Standard Dimensions for 1 1/8" (41.3mm) width series channel fittings (Unless Otherwise Shown on Drawing)  
 Hole Diameter: 9/16" (14.3mm); Hole Spacing - From End: 1 3/16" (20.6mm); Hole Spacing - On Center: 1 7/8" (47.6mm); Width: 1 5/8" (41.3mm); Thickness: 1/4" (6.4mm) with steel meeting or exceeding ASTM A1011 SS GR 33, or 0.220" (5.6mm) with steel meeting or exceeding ASTM A1011 HSLAS GR 45

**"U" Shape Fittings**

**P2800**

**EG, GR, HG**

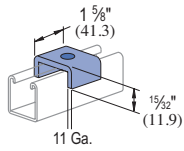

Part Number	Bolt Size (in)	Hole Size (in)	W/100 pcs Lbs (kg)
P2800-25	1/4"	9/32"	14 6.4
P2800-37	3/8"	7/16"	14 6.4
P2800-50	1/2"	9/16"	13 5.9
P2800-62	5/8"	1 1/16"	13 5.9
P2800-75	3/4"	1 3/16"	13 5.9

**P1363A THRU P1363E**

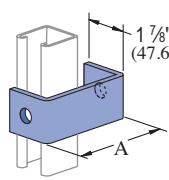

Part Number	"A" In (mm)	W/100 pcs Lbs (kg)
P1363A	4	78
P1363B	101.6	35.4
P1363C	5	89
P1363D	127.0	40.4
P1363E	6	101
	152.4	45.8
	7	112
	177.8	50.8
	8	124
	203.2	56.2

**P1320**

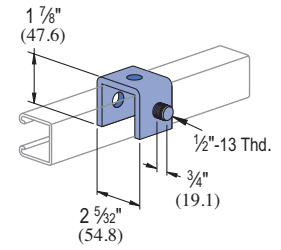

W/100 pcs: 63 Lbs (28.6 kg)

**P1376**

**EG, GR, HG**

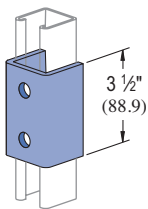

W/100 pcs: 128 Lbs (58.1 kg)

**P4376**

**EG, GR, HG**

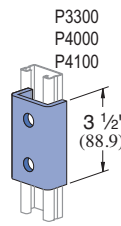

W/100 pcs: 85 Lbs (38.6 kg)

**P1376A**

**EG, GR, HG**

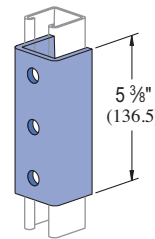

W/100 pcs: 197 Lbs (89.4 kg)

**P4376A**

**EG, GR, HG**

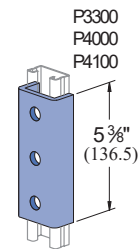

W/100 pcs: 130 Lbs (59.0 kg)

**P1377, P4377, P5077, P5577**

**EG, GR, HG**

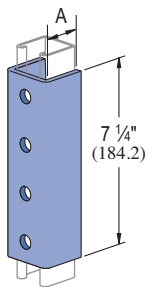

Part Number	For Use With	"A" in (mm)	W/100 pcs Lbs (kg)
P1377	P1000, P1100, P2000	1 9/16 39.7	265 120
P4377	P3300, P4000, P4100	1 9/16 23.8	176 80
P5077	P5000	3 9/16 81.0	390 177
P5577	P5500	2 3/8 60.3	310 141

**P1047**

**DF, EG, GR, HG**

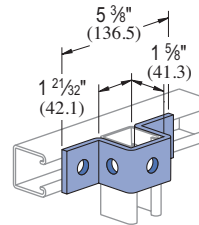

W/100 pcs: 88 Lbs (39.9 kg)

**P3047**

**EG, GR, HG**

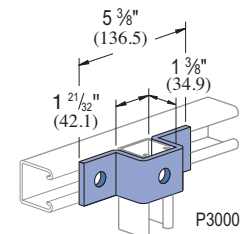

W/100 pcs: 84 Lbs (38.1 kg)

**P976**

**P4047**

**EG, GR, HG**

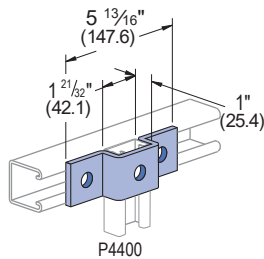

W/100 pcs: 71 Lbs (32.2 kg)

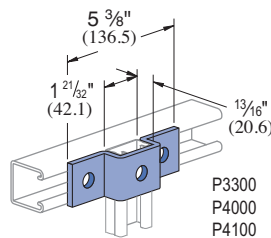

W/100 pcs: 71 Lbs (32.2 kg)

**P1455**

**EG, GR, HG**

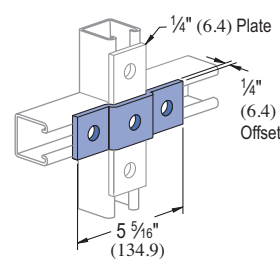

W/100 pcs: 58 Lbs (26.3 kg)

**P5547**

**EG, GR, HG**

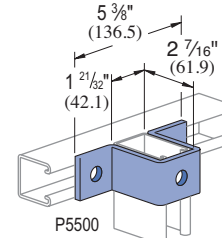

W/100 pcs: 108 Lbs (49.0 kg)

Standard Dimensions for 1 5/8" (41.3mm) width series channel fittings (Unless Otherwise Shown on Drawing)

Hole Diameter: 9/16" (14.3mm); Hole Spacing - From End: 1 3/16" (20.6mm); Hole Spacing - On Center: 1 7/8" (47.6mm); Width: 1 5/8" (41.3mm); Thickness: 1/4" (6.4mm) with steel meeting or exceeding ASTM A1011 SS GR 33, or 0.220" (5.6mm) with steel meeting or exceeding ASTM A1011 HSLAS GR 45



1 1/8" Channel

Telestrut

Nuts & Hardware

General Fittings

Pipe/Conduit Supports

Electrical Fittings

Concrete Inserts

Solar

Unipier®

**P1383** EG, GR, HG

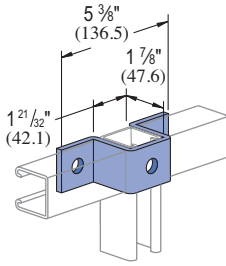

Wt/100 pcs: 95 Lbs (43.1 kg)

**P1732** EG, GR, HG

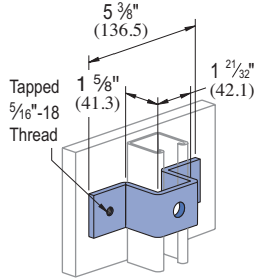

Wt/100 pcs: 88 Lbs (39.9 kg)

**P2237** EG, GR, HG

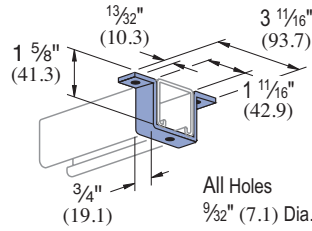

Material: 1/8" (3.2) thick.

Wt/100 pcs: 18 Lbs (8.2 kg)

**P5543** EG, GR, HG

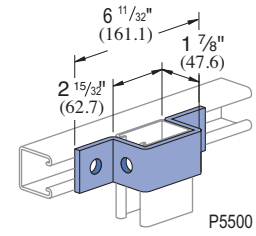

P5500

Wt/100 pcs: 97 Lbs (44.0 kg)

**P1048, P1049, P1050**

DF, EG, GR, HG

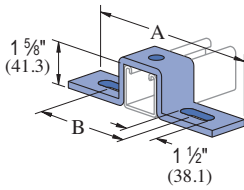

Part Number	"A" In (mm)	"B" In (mm)	Wt/100 pcs Lbs (kg)
P1048	7 1/4 184.2	4 1/8 104.8	105 47.6
P1049	8 1/2 215.9	5 1/8 136.5	120 54.4
P1050	10 3/8 263.5	7 1/4 184.2	130 59.0

**P1043A** EG, GR, HG

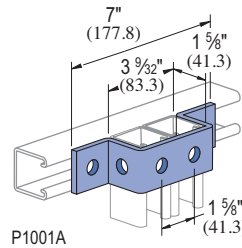

P1001A

Wt/100 pcs: 105 Lbs (47.6 kg)

**P1737** EG, GR, HG

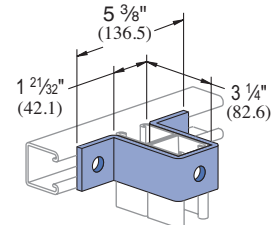

P1001 (shown), P1101, P2001, P4004 or P5000

Wt/100 pcs: 128 Lbs (58.1 kg)

**P2473** EG, GR, HG

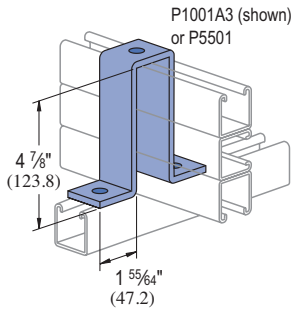

P1001A3 (shown) or P5501

Wt/100 pcs: 197 Lbs (89.4 kg)

**P4043** EG, GR, HG

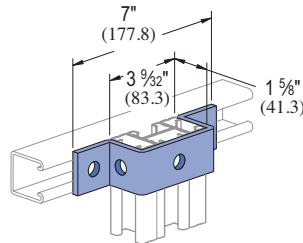

P4004 (shown), P1001, P1101, P2001, or P5000

Wt/100 pcs: 106 Lbs (48.1 kg)

**P1044** EG, GR, HG

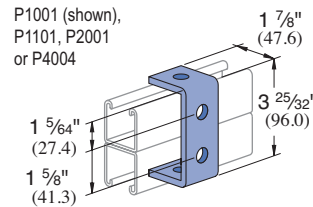

P1001 (shown), P1101, P2001 or P4004

Wt/100 pcs: 70 Lbs (31.8 kg)

**P1973** EG, GR, HG

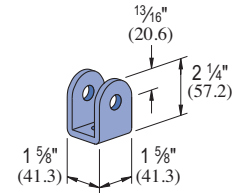

Wt/100 pcs: 53 Lbs (24.0 kg)

**P2326** EG, GR, HG

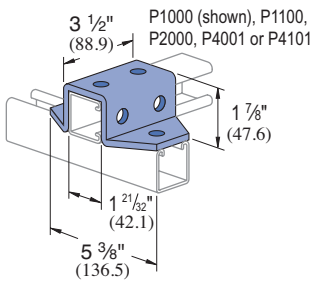

P1000 (shown), P1100, P2000, P4001 or P4101

Wt/100 pcs: 171 Lbs (77.6 kg)

**P2328**

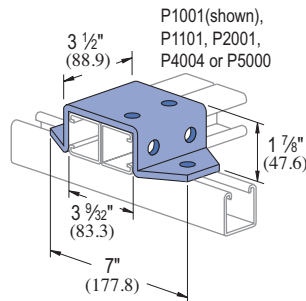

P1001 (shown), P1101, P2001, P4004 or P5000

Wt/100 pcs: 209 Lbs (94.8 kg)

**P2329**

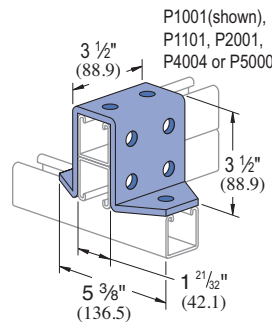

P1001 (shown), P1101, P2001, P4004 or P5000

Wt/100 pcs: 257 Lbs (116.6 kg)

**P1046A** EG, GR, HG

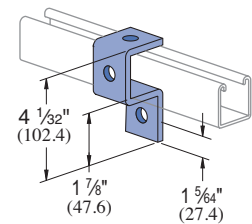

Wt/100 pcs: 76 Lbs (34.5 kg)

Standard Dimensions for 1 1/8" (41.3mm) width series channel fittings (Unless Otherwise Shown on Drawing)

Hole Diameter: 9/16" (14.3mm); Hole Spacing - From End: 1/16" (20.6mm); Hole Spacing - On Center: 1 1/8" (47.6mm); Width: 1 1/8" (41.3mm); Thickness: 1/4" (6.4mm) with steel meeting or exceeding ASTM A1011 SS GR.33, or 0.220" (5.6mm) with steel meeting or exceeding ASTM A1011 HSLAS GR.45



**Wing Shape Fittings**

**P2341 R-L** EG, GR, HG

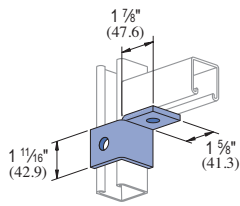

R - As shown  
L - Opposite hand

W/100 pcs: 60 Lbs (27.2 kg)

**P2224** EG, GR, HG

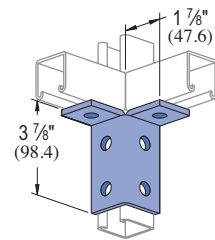

W/100 pcs: 115 Lbs (52.2 kg)

**P2229** EG, GR, HG

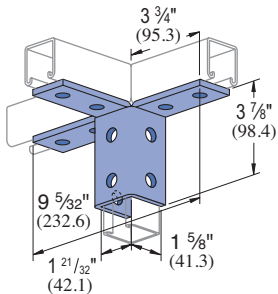

W/100 pcs: 230 Lbs (104.3 kg)

**P2344 R-L** EG, GR, HG

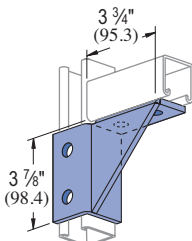

R - As shown  
L - Opposite hand

W/100 pcs: 176 Lbs (79.8 kg)

**P2472 R-L** EG, GR, HG

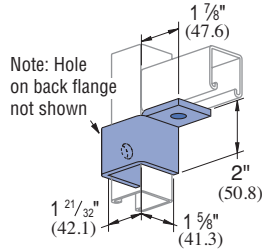

R - As shown  
L - Opposite hand

W/100 pcs: 75 Lbs (34.0 kg)

**P2225** EG, GR, HG

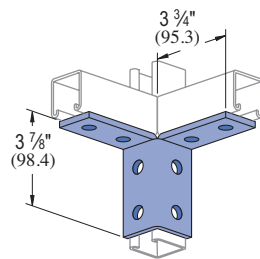

W/100 pcs: 155 Lbs (70.3 kg)

**P2345** EG, GR, HG

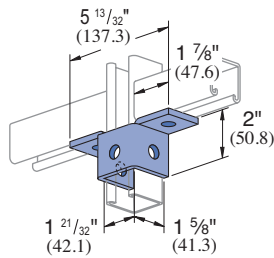

W/100 pcs: 93 Lbs (42.2 kg)

**P2226** EG, GR, HG

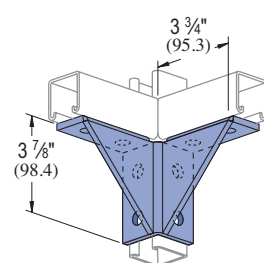

W/100 pcs: 217 Lbs (98.4 kg)

**P2343 R-L**

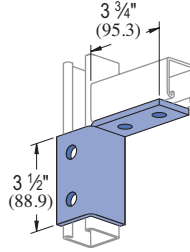

R - As shown  
L - Opposite hand

W/100 pcs: 119 Lbs (54.0 kg)

**P2227** EG, GR, HG

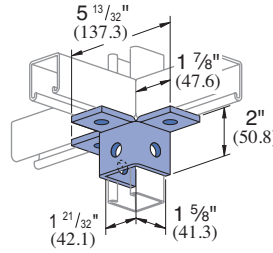

W/100 pcs: 113 Lbs (51.3 kg)

**P2346** EG, GR, HG

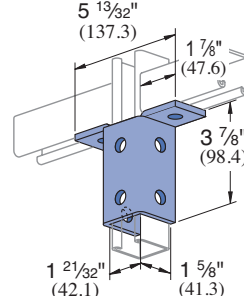

W/100 pcs: 150 Lbs (68.0 kg)

**P2230** EG, GR, HG

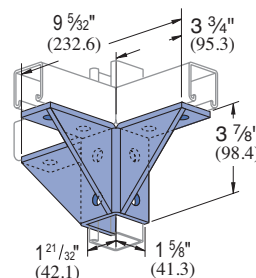

W/100 pcs: 310 Lbs (140.6 kg)

**P2223** EG, GR, HG

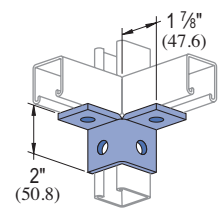

R - As shown  
L - Opposite hand

W/100 pcs: 76 Lbs (34.5 kg)

**P2228** EG, GR, HG

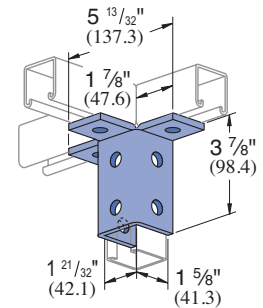

W/100 pcs: 177 Lbs (80.3 kg)

**P2347** EG, GR, HG

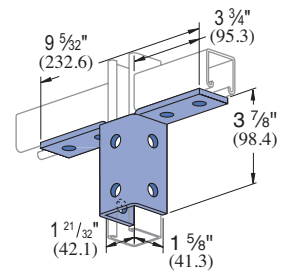

W/100 pcs: 193 Lbs (87.5 kg)

**P2245** EG, GR, HG

Fitting notched for continuous vertical.

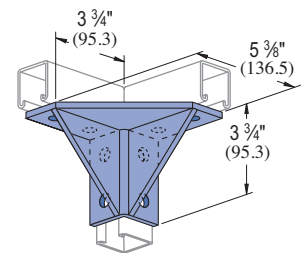

W/100 pcs: 315 Lbs (142.9 kg)

Standard Dimensions for 1 5/8" (41.3mm) width series channel fittings (Unless Otherwise Shown on Drawing)

Hole Diameter: 9/16" (14.3mm); Hole Spacing - From End: 1 3/16" (20.6mm); Hole Spacing - On Center: 1 7/8" (47.6mm); Width: 1 5/8" (41.3mm); Thickness: 1/4" (6.4mm) with steel meeting or exceeding ASTM A1011 SS GR 33, or 0.220" (5.6mm) with steel meeting or exceeding ASTM A1011 HSLAS GR 45



1 1/8" Channel

Telestrut

Nuts & Hardware

General Fittings

Pipe/Conduit Supports

Electrical Fittings

Concrete Inserts

Solar

Unipier®

**P2348** EG, GR, HG

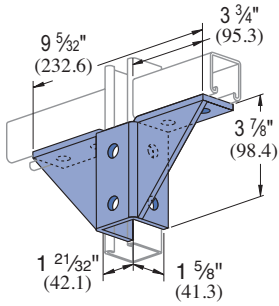

W/100 pcs: 274 Lbs (124.3 kg)

**P2453** EG, GR, HG

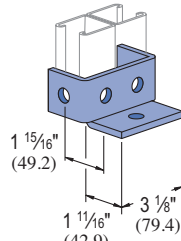

W/100 pcs: 116 Lbs (52.6 kg)

**P1887** EG, GR, HG

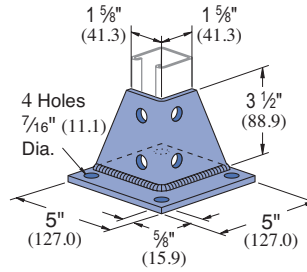

W/100 pcs: 297 Lbs (134.8 kg)

**P2941, P2942** EG, GR, HG

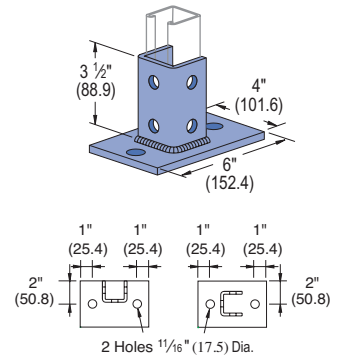

W/100 pcs: 358 Lbs (162.4 kg)

**P2072, P2072 SQ** EG, GR, HG

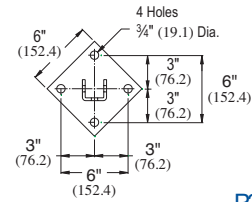
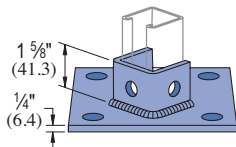

**P2072**

W/100 pcs: 307 Lbs (139.3 kg)

**P2072A, P2072A SQ** DF, EG, GR, HG

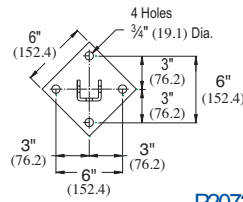
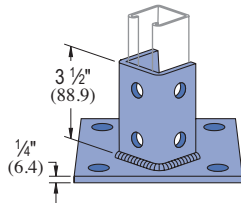

**P2072A**

W/100 pcs: 373 Lbs (169.2 kg)

**P2073, P2073 SQ** EG, GR, HG

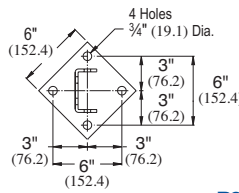
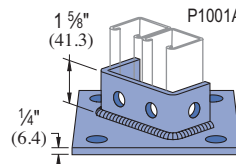

**P2073**

W/100 pcs: 325 Lbs (147.4 kg)

**P2073A, P2073A SQ** EG, GR, HG

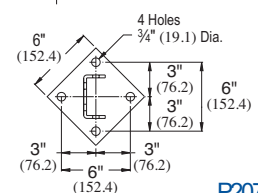
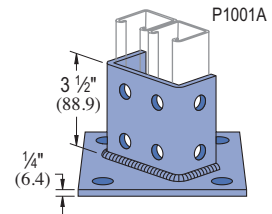

**P2073A**

W/100 pcs: 408 Lbs (185.1 kg)

**P1769** EG, GR

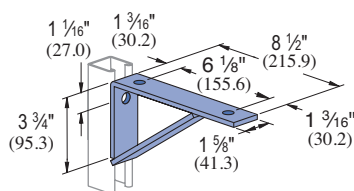

Material: 1/4" (6.4) thick steel.

W/100 pcs: 174 Lbs (78.9 kg)

Part No.	Gauge	Vertical Channel	Uniform Design Load
		Lbs (kN)	Lbs (kN)
P1000	12	800	3.56
P1100	14	600	2.67
P2000	16	400	1.81

Safety Factor 2 1/2

**P1771** EG, GR

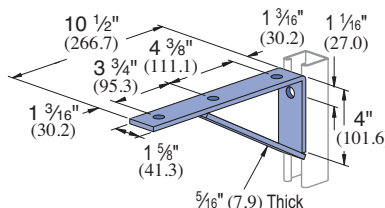

Material: 1/4" (6.4) thick steel.

W/100 pcs: 206 Lbs (93.4 kg)

Part No.	Gauge	Vertical Channel	Uniform Design Load
		Lbs (kN)	Lbs (kN)
P1000	12	800	3.56
P1100	14	600	2.67
P2000	16	400	1.81

Safety Factor 2 1/2

Standard Dimensions for 1 1/8" (41.3mm) width series channel fittings (Unless Otherwise Shown on Drawing)

Hole Diameter: 9/16" (14.3mm); Hole Spacing - From End: 1/16" (20.6mm); Hole Spacing - On Center: 1 1/8" (47.6mm); Width: 1 1/8" (41.3mm); Thickness: 1/4" (6.4mm) with steel meeting or exceeding ASTM A1011 SS GR 33, or 0.220" (5.6mm) with steel meeting or exceeding ASTM A1011 HSLAS GR 45

**Brackets**

**P1773**

EG, GR

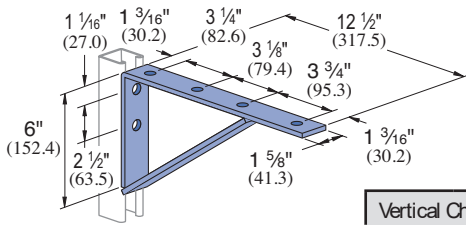

Material: 1/4" (6.4) thick steel.

Part No.	Gauge	Vertical Channel	Uniform Design Load Lbs (kN)
P1000	12	12	900 (4.00)
P1100	14	14	800 (3.56)
P2000	16	16	450 (2.04)

Safety Factor 2½

W/100 pcs: 264 Lbs (119.7 kg)

**P1775**

EG, GR

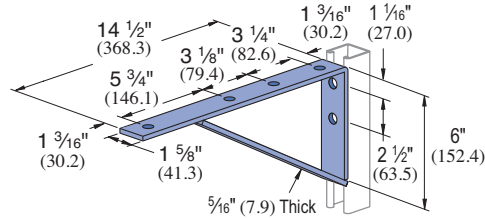

Material: 1/4" (6.4) thick steel.

Part No.	Gauge	Vertical Channel	Uniform Design Load Lbs (kN)
P1000	12	12	900 (4.00)
P1100	14	14	800 (3.56)
P2000	16	16	450 (2.04)

Safety Factor 2½

W/100 pcs: 295 Lbs (133.8 kg)

**P1075**

EG, GR

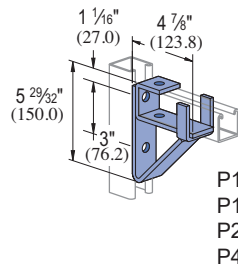

Material: 1/4" (6.4) thick steel.

Part No.	Gauge	Vertical Channel	Allowable Moment* In-Lbs (N•M)
P1000	12	12	5,100 (576)
P1100	14	14	4,400 (497)
P2000	16	16	3,200 (362)

Safety Factor 2½

\* Allowable moment for fitting only. Channel may determine overall capacity.

W/100 pcs: 229 Lbs (103.9 kg)

**P1593**

EG, GR

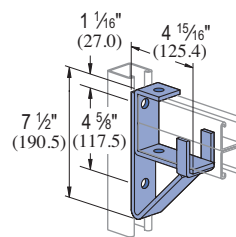

Material: 1/4" (6.4) thick steel.

Part No.	Gauge	Vertical Channel	Allowable Moment* In-Lbs (N•M)
P1000	12	12	13,000
P1100	14	14	9,100
P2000	16	16	6,500

Safety Factor 2½

W/100 pcs: 272 Lbs (123.4 kg)

\* Allowable moment for fitting only. Channel may determine overall capacity.

**P1777**

EG, GR

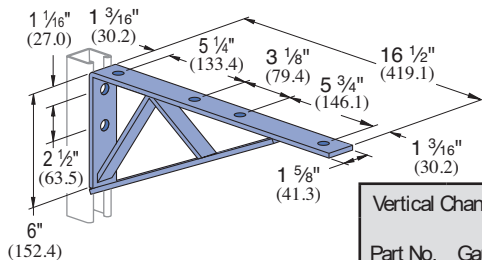

Material: 1/4" (6.4) thick steel.

Part No.	Gauge	Vertical Channel	Uniform Design Load Lbs (kN)
P1000	12	12	1,200 (5.44)
P1100	14	14	900 (4.00)
P2000	16	16	600 (2.67)

Safety Factor 2½

W/100 pcs: 385 Lbs (174.6 kg)

**P2547 THRU P2551**

**CABLE TRAY BRACKET**

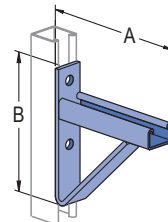

Part Number	"A" In (mm)	"B" In (mm)	W/100 pcs Lbs (kg)	Uniform Load* Lbs (kN)
P2547	15	8¾	420	1,000
P2548	21	8¾	628	1,000
P2549	27	11¼	860	900
P2550	33	11¼	1010	900
P2551	39	16	1257	800

**P2491 R-L THRU P2493 R-L**

EG, GR

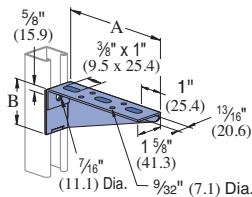

R - As shown; L - Opposite hand

Material : 12 Gauge Steel.

Part No.	Gauge	Vertical Channel	Uniform Design Load Lbs (kN)
P1000	12	12	300 (1.33)
P1100	14	14	250 (1.11)
P2000	16	16	200 (.89)

Safety Factor - 2½

Part Number	Stamped Ident. No.	"A" In (mm)	"B" In (mm)	W/100 pcs Lbs (kg)
P2491 R-L	121892 R-L	6	1½/16	67
P2492 R-L	121893 R-L	8	2¼/16	92
P2493 R-L	121894 R-L	10	2½/16	120

Standard Dimensions for 1½" (41.3mm) width series channel fittings (Unless Otherwise Shown on Drawing)

Hole Diameter: 5/16" (14.3mm); Hole Spacing - From End: 1¾" (20.6mm); Hole Spacing - On Center: 1½" (47.6mm); Width: 1½" (41.3mm); Thickness: ¼" (6.4mm) with steel meeting or exceeding ASTM A1011 SS GR 33, or 0.220" (5.6mm) with steel meeting or exceeding ASTM A1011 HSLAS GR 45



**P2494 R-L THRU P2499 R-L**

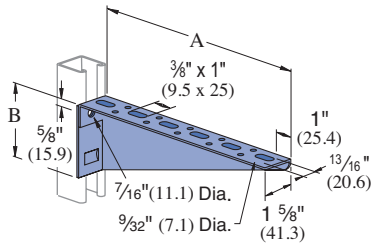

Vertical Channel Part No.	Gauge	Uniform Design Load Lbs (kN)
P1000	12	300 (1.33)
P1100	14	250 (1.11)
P2000	16	200 (.89)

Safety Factor - 2 1/2

Part Number	Stamped Ident. No.	"A" In (mm)	"B" In (mm)	Wt/100 pcs Lbs (kg)
P2494 R-L	121895 R-L	12	3 7/16	152
		304.8	87.3	68.9
P2495 R-L	121896 R-L	14	3 9/16	173
		355.6	100.0	78.5
P2496 R-L	121897 R-L	16	4 1/16	223
		406.4	112.7	101.2
P2497 R-L	121898 R-L	18	4 5/16	266
		457.2	125.4	120.7
P2498 R-L	121899 R-L	20	5 1/16	308
		508.0	138.1	139.7
P2499 R-L	121900 R-L	22	5 9/16	355
		558.8	150.8	161.0

Material : 12 Gauge Steel.  
R - As shown; L - Opposite hand

**P2500 R-L THRU P2503 R-L**

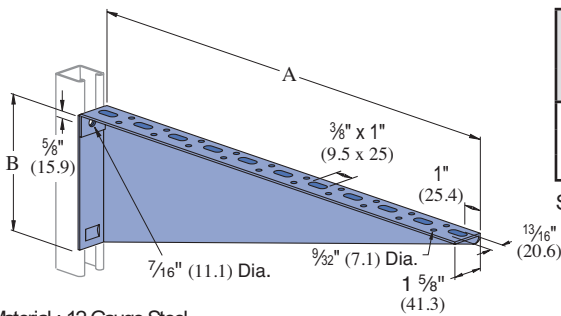

Vertical Channel Part No.	Gauge	Uniform Design Load Lbs (kN)
P1000	12	300 (1.33)
P1100	14	250 (1.11)
P2000	16	200 (.89)

Safety Factor - 2 1/2

Part Number	Stamped Ident. No.	"A" In (mm)	"B" In (mm)	Wt/100 pcs Lbs (kg)
P2500 R-L	121901 R-L	24	6 7/16	400
		609.6	164	181.4
P2501 R-L	121902 R-L	26	6 9/16	445
		660	176	201.8
P2502 R-L	121903 R-L	28	7 1/16	493
		711	189	223.6
P2503 R-L	121904 R-L	30	7 5/16	545
		762.0	202	247.2

Material : 12 Gauge Steel.  
R - As shown; L - Opposite hand

**P2944, P2945, P2946, P2947**

**EG, GR, HG**

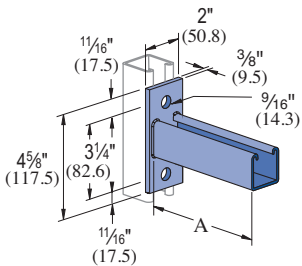

Part Number	"A" In (mm)	Wt/100 pcs Lbs (kg)	Uniform Load* Lbs (kN)
P2944	6	185	1200
	152.4	84	5.34
P2945	12	293	600
	304.8	133	2.67
P2946	18	401	400
	457.2	182	1.78
P2947	24	509	300
	609.6	231	1.33

Safety Factor 2 1/2  
\* Mounted on 12 Ga. Channel

**P2542 THRU P2546**

**EG, GR, HG**

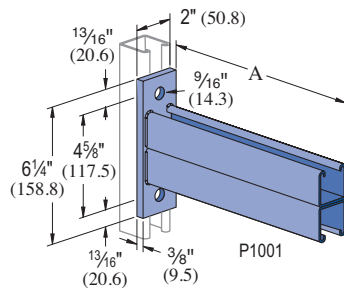

Safety Factor - 2 1/2

Part Number	"A" In (mm)	Wt/100 pcs Lbs (kg)	Vertical Channel Part No.	Gauge	Uniform Design Load Lbs (kN)
P2542	12	502	P1000	12	2,000 (8.90)
			P1100	14	1,400 (6.23)
			P2000	16	1,000 (4.45)
P2543	18	692	P1000	12	1,300 (5.78)
			P1100	14	900 (4.00)
			P2000	16	650 (2.89)
P2544	24	882	P1000	12	1,000 (4.45)
			P1100	14	700 (3.11)
			P2000	16	500 (2.22)
P2545	30	1,072	P1000	12	800 (3.56)
			P1100	14	560 (2.49)
			P2000	16	400 (1.78)
P2546	36	1,262	P1000	12	650 (2.89)
			P1100	14	450 (2.00)
			P2000	16	320 (1.42)

Standard Dimensions for 1 1/8" (41.3mm) width series channel fittings (Unless Otherwise Shown on Drawing)

Hole Diameter: 9/16" (14.3mm); Hole Spacing - From End: 1 3/16" (20.6mm); Hole Spacing - On Center: 1 7/8" (47.6mm); Width: 1 5/8" (41.3mm); Thickness: 1/4" (6.4mm) with steel meeting or exceeding ASTM A1011 SS GR 33, or 0.220" (5.6mm) with steel meeting or exceeding ASTM A1011 HSLAS GR 45

**Brackets**

**P2231, P2232**

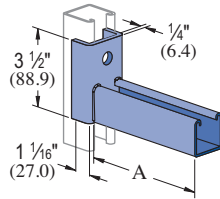

Part Number	"A" In (mm)	Wt/100 pcs Lbs (kg)	Vertical Channel Part No.	Vertical Channel Gauge	Uniform Design Load Lbs (kN)
P2231	6 152.4	191 86.6	P1000	12	1,600 (7.12)
			P1100	14	1,200 (5.34)
			P2000	16	800 (3.56)
P2232	12 304.8	292 132.4	P1000	12	800 (3.56)
			P1100	14	600 (2.67)
			P2000	16	400 (1.78)

Safety Factor - 2½

**P2231A, P2232A**

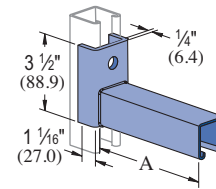

Part Number	"A" In (mm)	Wt/100 pcs Lbs (kg)	Vertical Channel Part No.	Vertical Channel Gauge	Uniform Design Load Lbs (kN)
P2231A	6 152.4	191 86.6	P1000	12	1,600 (7.12)
			P1100	14	1,200 (5.34)
			P2000	16	800 (3.56)
P2232A	12 304.8	292 132.4	P1000	12	800 (3.56)
			P1100	14	600 (2.67)
			P2000	16	400 (1.78)

Safety Factor - 2½

**P2233, P2234**

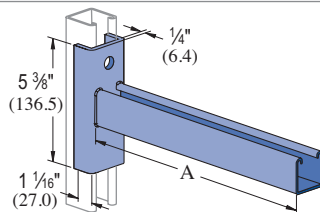

Part Number	"A" In (mm)	Wt/100 pcs Lbs (kg)	Vertical Channel Part No.	Vertical Channel Gauge	Uniform Design Load Lbs (kN)
P2233	18 457.2	436 197.8	P1000	12	600 (2.67)
			P1100	14	450 (2.00)
			P2000	16	300 (1.33)
P2234	24 609.6	536 243.1	P1000	12	450 (2.00)
			P1100	14	330 (1.47)
			P2000	16	220 (.98)

Safety Factor - 2½

**P2233A, P2234A**

GR, HG

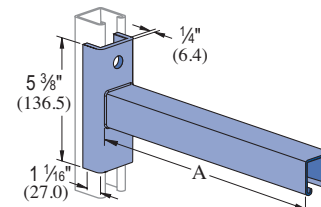

Part Number	"A" In (mm)	Wt/100 pcs Lbs (kg)	Vertical Channel Part No.	Vertical Channel Gauge	Uniform Design Load Lbs (kN)
P2233A	18 457.2	436 197.8	P1000	12	600 (2.67)
			P1100	14	450 (2.00)
			P2000	16	300 (1.33)
P2234A	24 609.6	536 243.1	P1000	12	450 (2.00)
			P1100	14	330 (1.47)
			P2000	16	220 (.98)

Safety Factor - 2½

**P2513 THRU P2516**

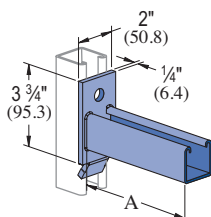

When installed in inverted position use 60% of loads shown.

Safety Factor 2½

Part Number	"A" In (mm)	Wt/100 pcs Lbs (kg)	Vertical Channel Part No.	Vertical Channel Gauge	Uniform Design Load Lbs (kN)
P2513	6 152.4	161 73.0	P1000	12	1,200 (5.34)
			P1100	14	800 (3.56)
			P2000	16	600 (2.67)
P2514	12 304.8	261 118.4	P1000	12	600 (2.67)
			P1100	14	400 (1.78)
			P2000	16	300 (1.33)
P2515	18 457.2	361 163.7	P1000	12	400 (1.78)
			P1100	14	270 (1.20)
			P2000	16	200 (.89)
P2516	24 609.6	461 209.1	P1000	12	300 (1.33)
			P1100	14	200 (.89)
			P2000	16	150 (.67)

**P2513A THRU P2516A**

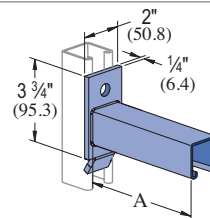

When installed in inverted position use 60% of loads shown.

Safety Factor 2½

Part Number	"A" In (mm)	Wt/100 pcs Lbs (kg)	Vertical Channel Part No.	Vertical Channel Gauge	Uniform Design Load Lbs (kN)
P2513A	6 152.4	161 73.0	P1000	12	1,200 (5.34)
			P1100	14	800 (3.56)
			P2000	16	600 (2.67)
P2514A	12 304.8	261 118.4	P1000	12	600 (2.67)
			P1100	14	400 (1.78)
			P2000	16	300 (1.33)
P2515A	18 457.2	361 163.7	P1000	12	400 (1.78)
			P1100	14	270 (1.20)
			P2000	16	200 (.89)
P2516A	24 609.6	461 209.1	P1000	12	300 (1.33)
			P1100	14	200 (.89)
			P2000	16	150 (.67)

Standard Dimensions for 1½" (41.3mm) width series channel fittings (Unless Otherwise Shown on Drawing)

Hole Diameter: 5/16" (14.3mm); Hole Spacing - From End: 13/16" (20.6mm); Hole Spacing - On Center: 1 1/8" (47.6mm); Width: 1 5/8" (41.3mm); Thickness: 1/4" (6.4mm)



1 1/8" Channel

Telestrut

Nuts & Hardware

General Fittings

Pipe/Conduit Supports

Electrical Fittings

Concrete Inserts

Solar

Unipier®

**P2815 ADJUSTABLE BRACE FITTING** EG GR

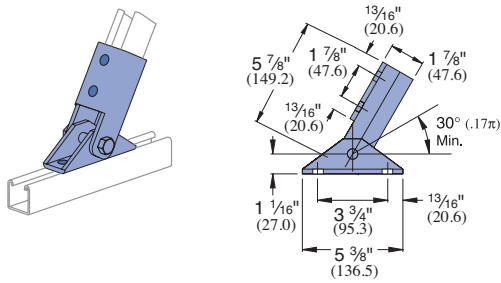

W/100 pcs: 307 Lbs (139.3 kg)

**P2815D ADJUSTABLE BRACE FITTING**

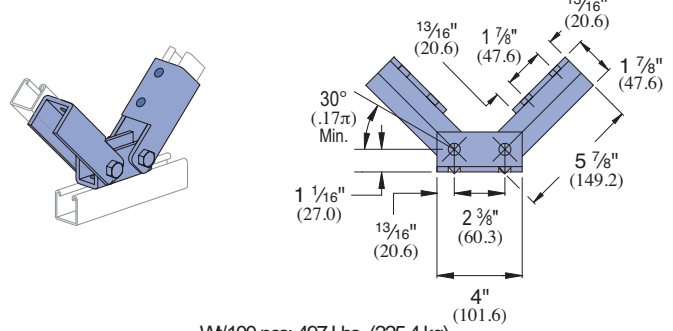

W/100 pcs: 497 Lbs (225.4 kg)

**P2452 KNEE BRACE** EG GR

**P2458-18 THRU P2458-36**

**TUBULAR KNEE BRACES**

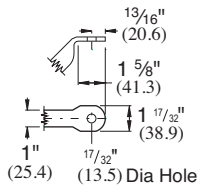
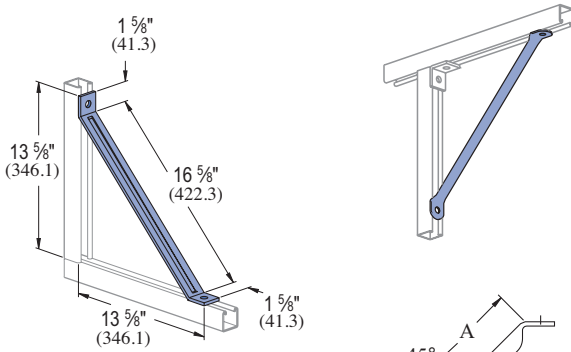

Part Number	"A" In (mm)	W/100 pcs Lbs (kg)
P2458-18	18	146
	457.2	66.2
P2458-24	24	186
	609.6	84.4
P2458-30	30	227
	762.0	103.0
P2458-36	36	267
	914.4	121.1

Design Axial Load  
1200 Lbs (5.34 kN)

Material: 1/4" (6.4) thick steel.

W/100 pcs: 277 Lbs (125.6 kg)

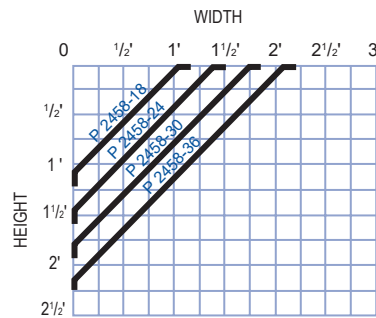

Design Loads  
Compression = 1500 Lbs (6.67 kN)  
Tension = 300 Lbs (1.33 kN)

**P2459-36 THRU P2459-96**

**TUBULAR BACK BRACES** EG GR

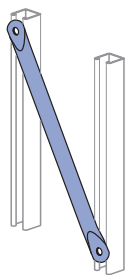

1. The vertical lines of the graph correspond to the center to center line dimension of the uprights.
2. Along this vertical line locate the (maximum usable) horizontal bracing height line.
3. The arc line that intersects the point formed by the intersection of the two lines, indicates the brace required.
4. 30° - 60° maximum, minimum brace angles are indicated for maximum effect.

Part Number	"A" In (mm)	W/100 pcs Lbs (kg)
P2459-36	36	255
	914.4	115.7
P2459-42	42	296
	1,066.8	134.3
P2459-48	48	336
	1,219.2	152.4
P2459-54	54	377
	1,371.6	171.0
P2459-60	60	418
	1,524.0	189.6
P2459-72	72	499
	1,828.8	226.3
P2459-84	84	580
	2,133.6	263.1
P2459-96	96	661
	2,438.4	299.8

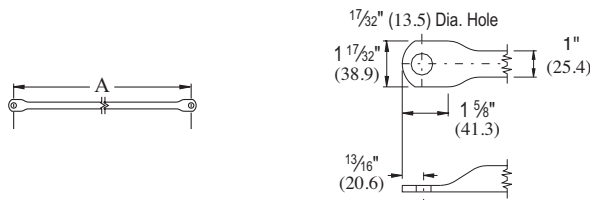
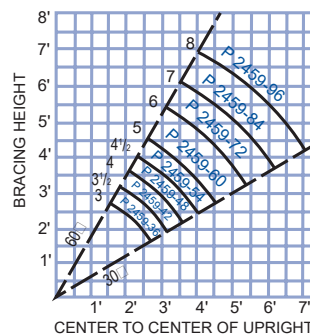

Standard Dimensions for 1 1/8" (41.3mm) width series channel fittings (Unless Otherwise Shown on Drawing)

Hole Diameter: 9/16" (14.3mm); Hole Spacing - From End: 13/16" (20.6mm); Hole Spacing - On Center: 1 7/8" (47.6mm); Width: 1 5/8" (41.3mm); Thickness: 1/4" (6.4mm) with steel meeting or exceeding ASTM A1011 SS GR 33, or 0.220" (5.6mm) with steel meeting or exceeding ASTM A1011 HSLAS GR 45

**Beam Clamps**

**P2897**

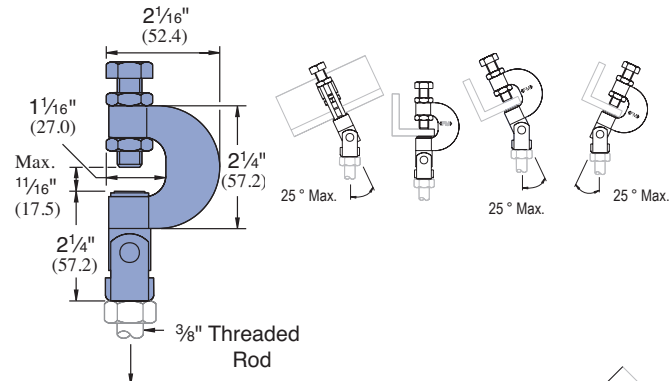

Design Load (Safety Factor of 4)  
(angles ≤ 25°) - 550 Lbs (2.45 kN)  
(angles > 25°) - 330 Lbs (1.47 kN)

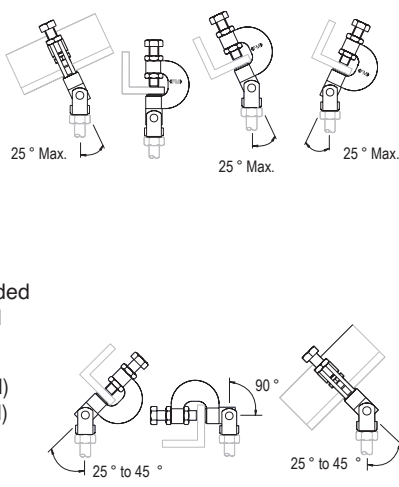

Safety Factor 4

Torque: 13 Ft-Lbs (18 N·m)

W/100 pcs: 33 Lbs (15.0 kg)

**P2784**

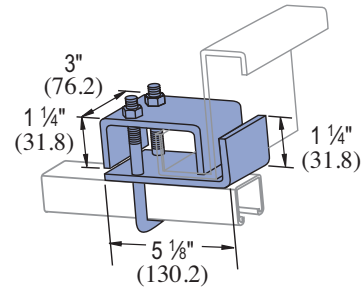

Part Number	For Use With	Load Lbs (kN)	W/100 pcs Lbs (kg)
P2784-1	P1000, P1100, P2000	1,200 5.34	175 79.3
P2784-2	P1001, P1101, P2001	1,200 5.34	179 81.1
P2784-3	P5001, P5501	1,200 5.34	180 81.5

**P2675**

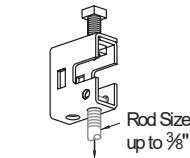
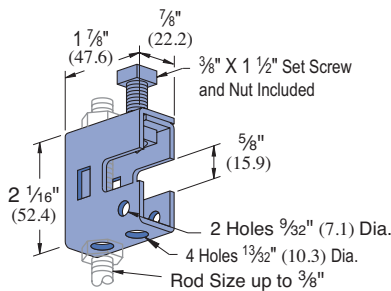

Design Load  
250 Lbs (1.11 kN)

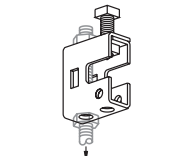

Design Load  
150 Lbs (.67 kN)

Clamp Materials: .105" (2.7) thick steel.  
Clamp P2675 is designed for light duty rod suspension.  
It also may be used with P3016-1024 or P3016-1420 nut as illustrated above for mounting insulators, etc.

W/100 pcs: 33 Lbs (15.0 kg)

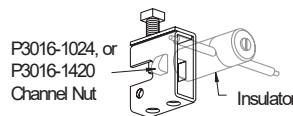

**P8000, P8001 – JUNIOR DUCTILE IRON TOP BEAM CLAMP**

**Material:** 3/8" and 1/2" rod sizes

**Finish:** Plain (PL) and Electro-Galvanized (EG)

**Function:** Structural attachment to top or bottom of metal beams, purlins, channel, or angle iron

**Features:**

- Set screw made of hardened steel
- Complies with Federal Specification A-A192A (Type 19) and MSS SP-69 (Type 19)



Part No. Plain & EG	Rod Size	Max Load Top Lbs*	Max Load Bottom Lbs*	Weight Lbs	W
P8000	3/8	500	250	0.33	7/8
P8001	1/2	950	760	0.34	1 1/16

NOTE: \*Max load may exceed allowable load for threaded rod size shown.

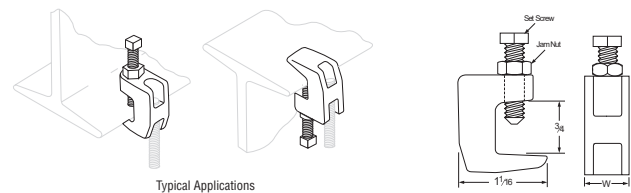

Note: When used for mechanical supports, load capacities of brackets, fittings and other supporting elements should be in compliance with the American Standard Code for Pressure Piping. Clamps are designed to be used with W, M, S & HP Shape beams, Standard C & Misc. MC Channels, Angles & Structural Tees. Clamps must be used in pairs where indicated. For beam clamps with HG finish, standard hardware is EG finish. For optional stainless steel hardware, please contact the factory for availability.

1 5/8" Channel  
Telestrut  
Nuts & Hardware  
General Fittings  
Pipe/Conduit Supports  
Electrical Fittings  
Concrete Inserts  
Solar  
Unipier®



**P2676**

**EG GR**

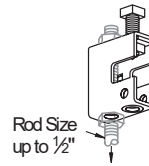
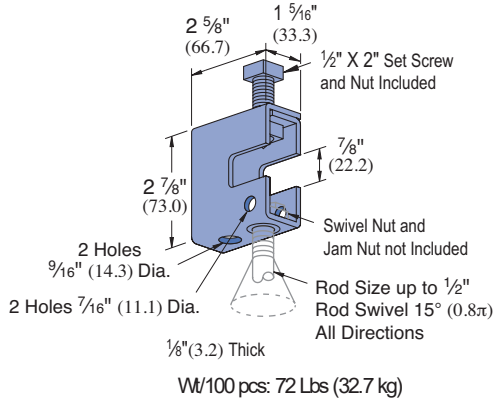

Design Load  
300 Lbs (1.33 kN)



Design Load  
500 Lbs (2.22 kN)

Clamp P2676 provides a means of rod suspension where a free swing of up to 15° (0.8π) is required. Clamp will accommodate 1/4" (6.4), 3/8" (9.5), or 1/2" (12.7) rods. Order swivel nuts P2679-4, -6, or -8 as required. Clamp may also be used with P2677 as illustrated in application drawings.

Clamp Materials: 1/8" (3.2) thick steel. Not available in SS or ST.

**P2898**

**UNIVERSAL BEAM CLAMP EG**

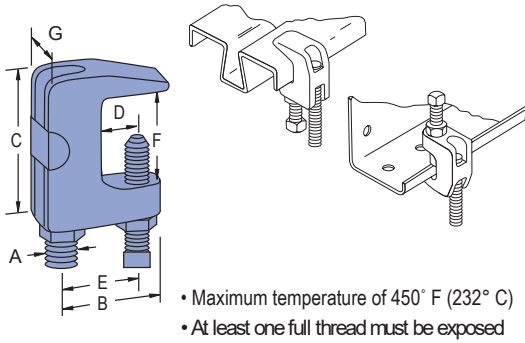

	A In	B In (mm)	C In (mm)	D In (mm)	E In (mm)	F In (mm)	G In (mm)	Max Load Lbs (kN)	W/100 pcs Lbs (kg)
P2898-37	3/8	1 25.4	1 1/2 38.1	1/2 12.7	1 25.4	3/4 19.1	7/8 22.2	400 1.78	33 15.0
P2898-50	1/2	1 5/16 25.4	1 1/2 38.1	1/2 12.7	1 25.4	3/4 19.1	7/8 22.2	500 2.22	33 15.0
P2898-62	5/8	1 1/2 38.1	1 1/2 38.1	1/2 12.7	1 25.4	3/4 19.1	1 25.4	600 2.67	22 10.0
P2898-75	3/4	1 7/8 47.6	1 3/4 44.5	5/8 15.9	1 1/8 34.9	1 25.4	1 1/4 31.8	800 3.56	88 40.0
P2898-87	7/8	2 50.8	1 3/4 44.5	5/8 15.9	1 1/2 38.1	1 25.4	1 1/4 31.8	1,200 5.34	79 35.9

**P2899**

**WIDE THROAT BEAM CLAMP EG**

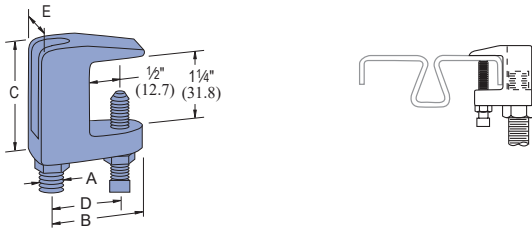

• Maximum temperature of 450° F (232° C)

	Rod Size					Max. Load	W/100 pcs
	A in	B In (mm)	C In (mm)	D In (mm)	E In (mm)	Lbs (kN)	Lbs (kg)
P2899-37	3/8	1 1/8 41.3	2 50.8	1 25.4	7/8 22.2	400 1.78	28 12.7
P2899-50	1/2	1 5/8 41.3	2 50.8	1 25.4	7/8 22.2	500 2.22	34 15.4
P2899-62	5/8	1 3/4 44.5	2 1/4 57.2	1 1/4 31.8	1 25.4	600 2.67	66 30.0
P2899-75	3/4	1 7/8 47.6	2 3/8 60.3	1 3/8 34.9	1 1/4 31.8	800 3.56	83 37.7

**P2682**

**EG**

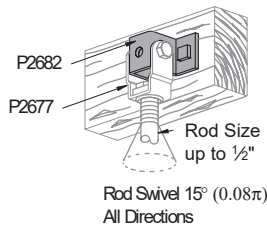
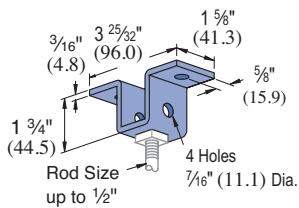

Hanger devis for up to 1/2" (12.7) rod suspension from wood ceilings. May also be used with P2677 as illustrated in application drawings.

W/100 pcs: 55 Lbs (24.9 kg)

**P2677**

**EG**

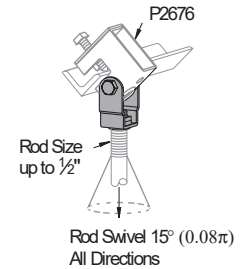
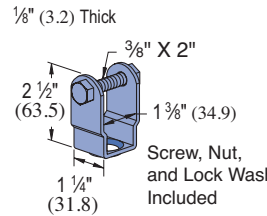

Clevis hanger to be used with P2676 or P2682 to provide angle adjustment and 15° (0.08π) free swing for up to 1/2" (12.7) rod suspension. Order swivel nuts P2679-4, -6, or -8 as required.

Design Load  
500 Lbs (2.22 kN)

W/100 pcs: 30 Lbs (13.6 kg)

**P2679-4, -6 & -8**

**SWIVEL NUT EG**

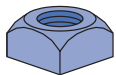

Part No.	Thread Size	W/100 pcs Lbs (kg)
P2679-4	1/4"-20	4 (1.8)
P2679-6	3/8"-16	5 (2.3)
P2679-8	1/2"-13	6 (2.7)

• Use w/P2676 and P2677.  
• Order size as required.

Note: When used for mechanical supports, load capacities of brackets, fittings and other supporting elements should be in compliance with the American Standard Code for Pressure Piping. Clamps are designed to be used with W, M, S & HP Shape beams, Standard C & Misc. MC Channels, Angles & Structural Tees. Clamps must be used in pairs where indicated. For beam clamps with HG finish, standard hardware is EG finish. For optional stainless steel hardware, please contact the factory for availability.



**Beam Clamps**

**P2674**

EG GR

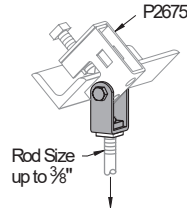
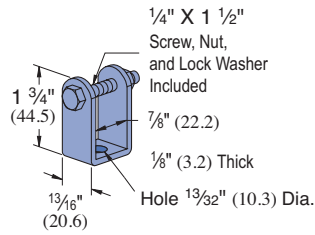

Clevis hanger to be used with P2675 to provide angle adjustment for up to 3/8" rod suspension as illustrated.

**Design Load**  
250 Lbs (1.11 kN)

Wt/100 pcs: 17 Lbs (7.7 kg)

**P1640**

EG GR

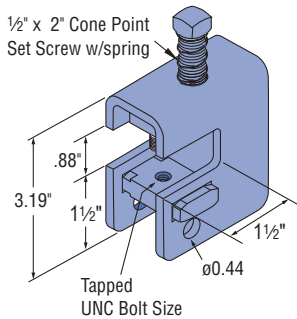

Part Number	Thread Size
P1640-025	1/4"-20
P1640-037	3/8"-16
P1640-050	1/2"-13

**P2398S, P2401S, P2403S, P2405S**

EG GR

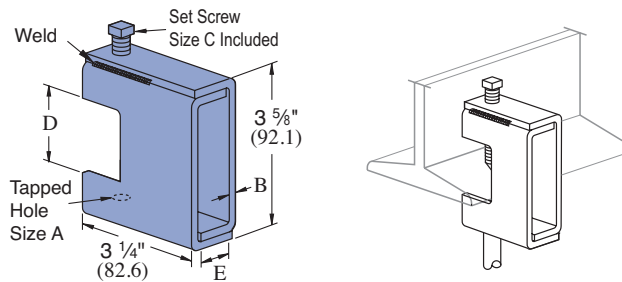

Weld is not continuous it is either 1/4" (31.8) - 1/4" (44) long or 2 spot welds. All welds are on the top and bottom.

For beams between 3/4" (19.1) to 1 1/8" (41.3) thick flanges.

Part Number	"A" In	"B" In (mm)	"C" In	"D" In (mm)	"E" In (mm)	Wt/100 pcs Lbs (kg)	Design Load Lbs (kN)
P2398S	1/4 - 20	3/8	3/8 x 2	1 1/2	7/8	109	800
		3.2		42.1	22.2	49.4	3.56
P2401S	3/8 - 16	3/16	1/2 x 2	1 1/16	29/32	156	1,300
		4.8		42.9	23.0	70.8	5.78
P2403S	1/2 - 13	1/4	1/2 x 2	1 1/16	15/16	201	1,900
		6.4		42.9	23.8	91.2	8.45
P2405S	5/8 - 11	5/16	5/8 x 2	1 1/16	15/16	311	2,400
		7.9		42.9	33.3	141.1	10.68

**P1648S THRU P1653S**

EG GR

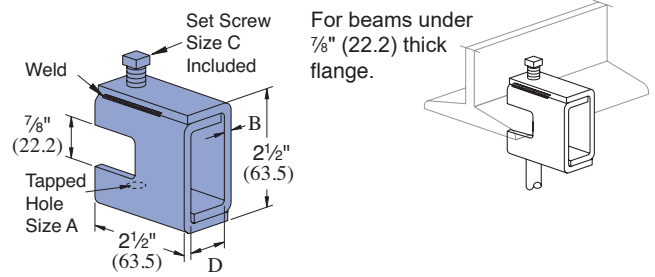

For beams under 7/8" (22.2) thick flange.

Weld is not continuous it is either 1/4" (31.8) - 1/4" (44.5) long or 2 spot welds. All welds are on the top and bottom.

Part Number	"A" In	"B" In (mm)	"C" In	"D" In (mm)	Wt/100 pcs Lbs (kg)	Design Load Lbs (kN)
P1648S	1/4 - 20	3/8	3/8 x 1 1/2	7/8	67	650
		3.2		22.2	30.4	2.89
P1649S	5/16 - 18	1/8	3/8 x 1 1/2	7/8	67	650
		3.2		22.2	30.4	2.89
P1650S	3/8 - 16	3/16	1/2 x 1 1/2	15/16	100	1,100
		4.8		23.8	45.4	4.89
P1651S	1/2 - 13	1/4	1/2 x 1 1/2	15/16	130	1,600
		6.4		23.8	59.0	7.12
P1652S	5/8 - 11	5/16	5/8 x 1 1/2	15/16	160	2,400
		7.9		33.3	72.6	10.68
P1653S	3/4 - 10	5/16	5/8 x 1 1/2	15/16	160	2,400
		7.9		33.3	72.6	10.68

**P1654A THRU P1661A**

RETAINER STRAP EG GR

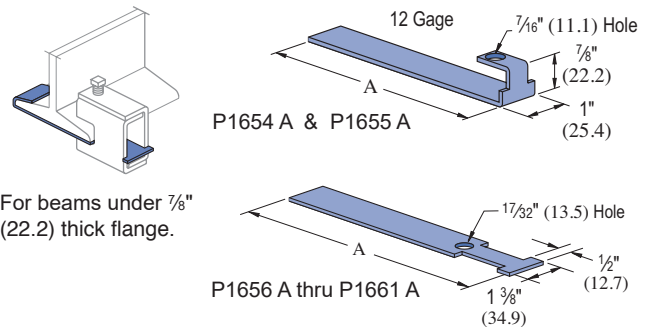

For beams under 7/8" (22.2) thick flange.

Strap Part Number	Flange Width In (mm)	"A" In (mm)	Wt/100 pcs Lbs (kg)	Beam Clamp Used With
P1654A	6	7	25	P2675
	152.4	177.8	11.3	
P1655A	9	10	34	P2675
	228.6	254.0	15.4	
P1656A	6	9	35	P1648 S Thru P1651 S, P2398S, P2401S & P2403S
P1657A	9	12	47	
P1658A	12	15	59	
	304.8	381.0	26.8	
P1659A	6	9	33	P2676
	152.4	228.6	15.0	
P1660A	9	12	45	P2676
	228.6	304.8	20.4	
P1661A	12	15	57	P2676
	304.8	381.0	25.9	

Note: When used for mechanical supports, load capacities of brackets, fittings and other supporting elements should be in compliance with the American Standard Code for Pressure Piping. Clamps are designed to be used with W, M, S & HP Shape beams, Standard C & Misc. MC Channels, Angles & Structural Tees. Clamps must be used in pairs where indicated. For beam clamps with HG finish, standard hardware is EG finish. For optional stainless steel hardware, please contact the factory for availability.



1 1/8" Channel

Telestrut

Nuts & Hardware

General Fittings

Pipe/Conduit Supports

Electrical Fittings

Concrete Inserts

Solar

**P1271S** **DF, EG, GR, HG**

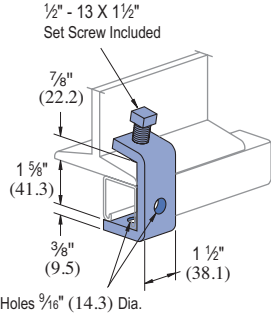

Note: Requires P1010 Channel Nut and bolt.

Design Load Each  
500 Lbs (2.22 kN)  
Use in Pairs Only

Wt/100 pcs: 95 Lbs (43.1 kg)

**P1796S** **EG GR HG**

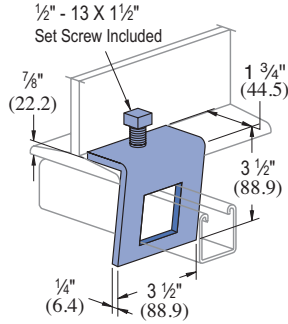

Design Load Each  
500 Lbs (2.22 kN)  
Use in Pairs Only

Wt/100 pcs: 91 Lbs (41.3 kg)

**P2824-6,-9,-12** **EG GR HG**

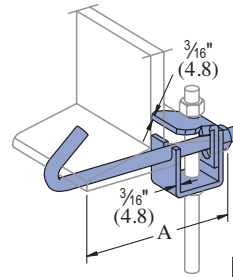

For use with Beams up to 3/4" (19.1) max flange thickness

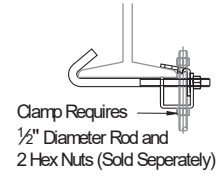

Part Number	"A" In (mm)	Wt/100 pcs Lbs (kg)	Design Load Lbs (kN)
P2824-6	2 1/2 - 6	125	500
	63.5 - 152.4	56.7	2.22
P2824-9	5 1/2 - 9	140	500
	139.7 - 228.6	63.5	2.22
P2824-12	8 1/2 - 12	171	500
	215.9 - 304.8	77.6	2.22

**P2785** **DF, EG, GR, HG**

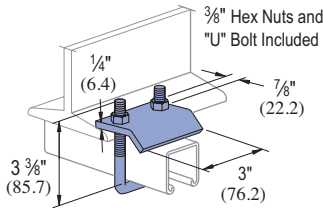

• For use with Beams up to 3/4" (19.1) Flanges and with Channels P1000, P1100, P2000, P3000, P3300, P3301, P4000, P4001, P4100, and P4101.

Design Load Each  
1000 Lbs (4.45 kN)  
Use in Pairs Only

Wt/100 pcs: 83 Lbs (37.6 kg)

**P2786** **DF, EG, GR, HG**

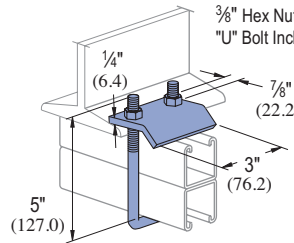

• For use with Beams up to 3/4" (19.1) Flanges and with Channels P1001, P1101, P2001, P3001, P5000, and P5500.

Design Load Each  
1000 Lbs (4.45 kN)  
Use in Pairs Only

Wt/100 pcs: 92 Lbs (41.7 kg)

**P2787** **DF, EG, HG**

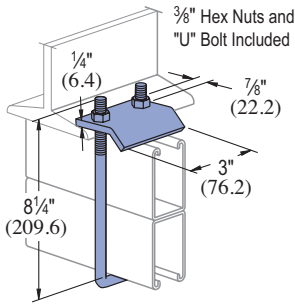

• For use with Beams up to 3/4" (19.1) Flanges and with Channels P5001 and P5501.

Design Load Each  
1000 Lbs (4.45 kN)  
Use in Pairs Only

Wt/100 pcs: 112 Lbs (50.8 kg)

**P2867** **EG GR HG**

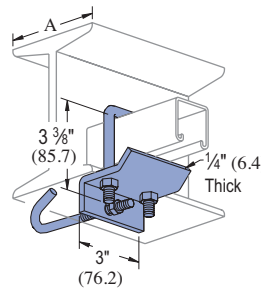

Part Number	Beam Size "A"	Wt/100 pcs Lbs (kg)
P2867	4"-6"	142 (64.4)
P2867-9	6"-9"	151 (68.5)
P2867-12	9"-12"	160 (72.6)
P2867-15	12"-15"	170 (77.1)
P2867-18	15"-18"	179 (81.2)

• Includes: "J" Bolt, "U" Bolt and Hex Nuts.  
• For use with Channels P1000, P1100, P2000, P3000, P3300, P3301, P4000, P4001, P4100, and P4101.

**P2867A** **EG GR HG**

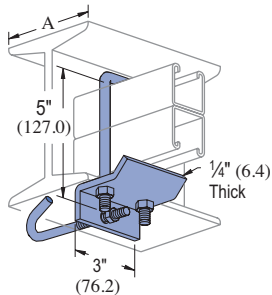

Part Number	Beam Size "A"	Wt/100 pcs Lbs (kg)
P2867A	4"-6"	151 (68.5)
P2867A-9	6"-9"	157 (71.2)
P2867A-12	9"-12"	166 (75.3)
P2867A-15	12"-15"	176 (79.8)
P2867A-18	15"-18"	185 (83.9)

• Includes: "J" Bolt, "U" Bolt and Hex Nuts.  
• For use with Channel P1001, P1101, P2001, P3001, P5000, and P5500.

**P2867B** **EG GR HG**

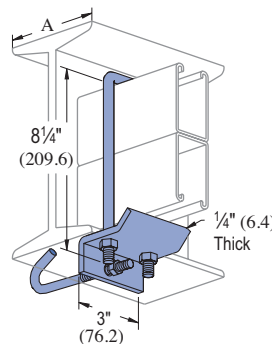

Part Number	Beam Size "A"	Wt/100 pcs Lbs (kg)
P2867B	4"-6"	161 (73.0)
P2867B-9	6"-9"	167 (75.7)
P2867B-12	9"-12"	176 (79.8)
P2867B-15	12"-15"	186 (84.4)
P2867B-18	15"-18"	195 (88.5)

• Includes: "J" Bolt, "U" Bolt and Hex Nuts.  
• For use with Channel P5001, and P5501.

Note: When used for mechanical supports, load capacities of brackets and fittings should be in compliance with the American Standard Code for Pressure Piping. Clamps are designed to be used with W, M, S & HP Shape beams, Standard C & Misc. MC Channels, Angles & Structural Tees. Clamps must be used in pairs where indicated. For beam clamps with HG finish, standard hardware is EG finish. For optional stainless steel hardware, please contact the factory for availability.

**Beam Clamps**

**P2868**

EG GR HG

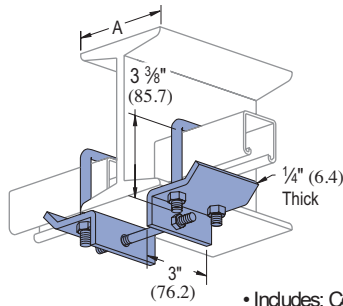

Part Number	Beam Size "A"	W/100 pcs Lbs (kg)
P2868	4"-6"	282 (127.9)
P2868-9	6"-9"	289 (131.1)
P2868-12	9"-12"	296 (134.3)
P2868-15	12"-15"	304 (137.9)
P2868-18	15"-18"	311 (141.1)

- Includes: Center Rod, "U" Bolts and Hex Nuts.
- For use with Channels P1000, P1100, P2000, P3000, P3300, P3301, P4000, P4001, P4100, and P4101.

**P2868A**

EG GR HG

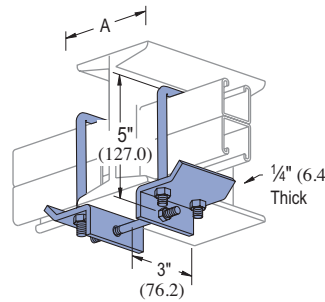

Part Number	Beam Size "A"	W/100 pcs Lbs (kg)
P2868A	4"-6"	300 (136.1)
P2868A-9	6"-9"	307 (139.3)
P2868A-12	9"-12"	314 (142.2)
P2868A-15	12"-15"	322 (146.1)
P2868A-18	15"-18"	329 (149.2)

- Includes: Center Rod, "U" Bolts and Hex Nuts.
- For use with Channels P1001, P1101, P2001, P3001, P5000, and P5500.

**P2868B**

EG GR HG

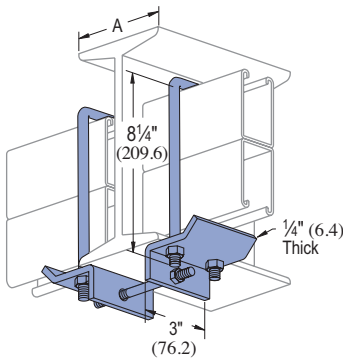

Part Number	Beam Size "A"	W/100 pcs Lbs (kg)
P2868B	4"-6"	320 (145.1)
P2868B-9	6"-9"	327 (148.3)
P2868B-12	9"-12"	334 (151.5)
P2868B-15	12"-15"	342 (155.1)
P2868B-18	15"-18"	349 (153.3)

- Includes: Center Rod, "U" Bolts and Hex Nuts.
- For use with Channels P5001, and P5501.

**P2894**

EG

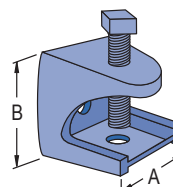

Material: Malleable Iron  
7/8" Maximum Flange Thickness  
Note: Tapped Hole on Top and Bottom

Part Number	Rod Size In	"A" In (mm)	"B" In (mm)	Load Ratings Lbs (kN)	W/100 pcs Lbs (kg)
P2894-25	1/4	1 1/8	1 1/4	150	23
		28.6	31.8	.67	10.4
P2894-37	3/8	2	2	350	95
		50.8	50.8	1.56	43.1
P2894-50	1/2	2 5/8	2 1/2	400	195
		66.7	63.5	1.78	88.5

**P2893**

EG

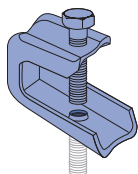

Material: Steel  
Use With: 1/4" rod  
Load Rating: 75 lbs. (.33 kN)

W/100 pcs: 14 lbs. (6.4 kg)

**P2895**

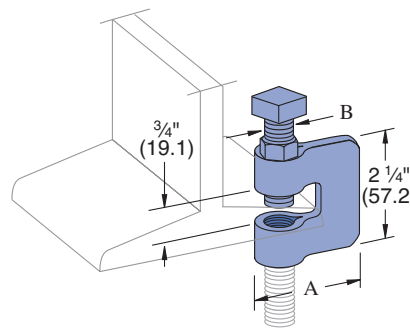

Material: Steel

Part Number	Rod Size In	"A" In (mm)	"B" In (mm)	Load Ratings Lbs (kN)	W/100 pcs Lbs (kg)
P2895-37	3/8	2 5/16	3/8	330	35
		58.7	9.5	1.47	15.9
P2895-50	1/2	2 1/4	1/2	380	41
		57.2	12.7	1.69	18.6
P2895-62	5/8	2 3/8	5/8	450	67
		60.3	15.9	2.00	30.4
P2895-75	3/4	2 1/4	1/2	500	72
		57.2	12.7	2.22	32.7

**P2896**

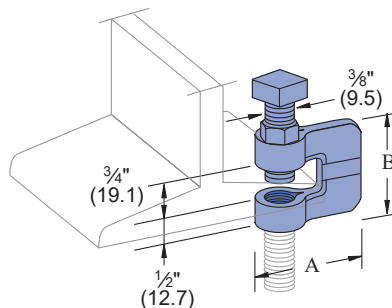

Material: Malleable Iron,  
Steel Set Screw

Part Number	Rod Size In	"A" In (mm)	"B" In (mm)	Load Ratings Lbs (kN)	W/100 pcs Lbs (kg)
P2896-37	3/8	1 1/16	1 1/4	400	38
		42.9	44.5	1.78	17.2
P2896-50	1/2	1 3/32	1 1/4	400	52
		43.7	44.5	1.78	23.6
P2896-62	5/8	1 5/16	2	450	68
		49.2	50.8	2.00	30.8
P2896-75	3/4	2 1/32	2	600	128
		51.6	50.8	2.67	58.1

Note: When used for mechanical supports, load capacities of brackets, fittings and other supporting elements should be in compliance with the American Standard Code for Pressure Piping. Clamps are designed to be used with W, M, S & HP Shape beams, Standard C & Misc. MC Channels, Angles & Structural Tees. Clamps must be used in pairs where indicated. For beam clamps with HG finish, standard hardware is EG finish. For optional stainless steel hardware, please contact the factory for availability.



**P1386**

DF, EG, GR, HG

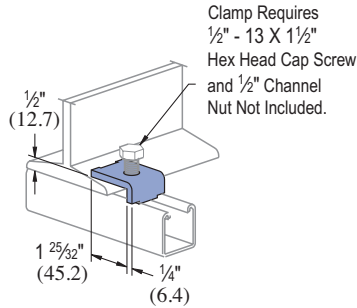

Clamp Requires 1/2" - 13 X 1 1/2" Hex Head Cap Screw and 1/2" Channel Nut Not Included.

Channel Style	Design Load Each (Use in Pairs Only) Lbs (kN)
P1000	600 2.67
P1100	500 2.22
P2000	450 2.00

W/100 pcs: 27 Lbs (12.2 kg)

**P1379S**

EG GR HG

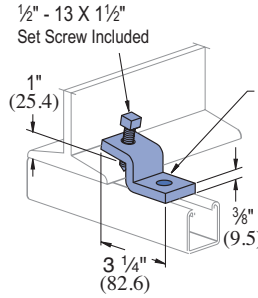

Clamp Requires 1/2" x 1 3/16" Hex Head Cap Screw and 1/2" Channel Nut Not Included.

Channel Style	Design Load Each (Use in Pairs Only) Lbs (kN)
P1000	600 2.67
P1100	500 2.22
P2000	450 2.00

W/100 pcs: 75 Lbs (34.0kg)

**P1272S, P1985S, P1986S**

EG GR HG

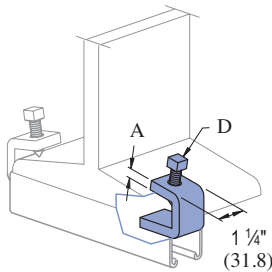

Part Number	"A" In (mm)	Flange Thickness In (mm)	"D" Set Screw Included	W/100 pcs Lbs (kg)	Design Load Per Pair (Use in Pairs Only) Lbs (kN)
P1272S	1/4	Up to 3/4	3/8-16 x 1 1/2	39	450
	6.4	Up to 19.1		17.7	2.00
P1985S	3/8	Up to 3/4	1/2-13 x 1 1/2	62	1,000
	9.5	Up to 19.1		28.1	4.45
P1986S	3/8	7/8 to 2	1/2-13 x 1 1/2	74	900
	9.5	22.2 - 50.8		33.6	4.00

**P3087**

COLUMN INSERT

EG

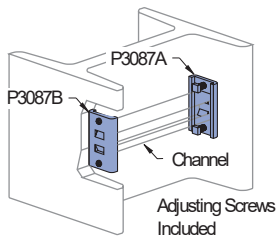

Channel Part Number	Design Pull Out Load Lbs (kN)	Design Slip Load Lbs (kN)
P1000	1,000 4.45	800 3.56
P1100	700 3.34	500 2.22
P2000	500 2.22	300 1.33

Safety factor of 3.

- Adjusting Screws Included.
- Unistrut channel not included.
- Part number P3087 consists of:
  - (1) piece P3087A,
  - (1) piece P3087B and
  - (2) set screws, 3/8" Dia.

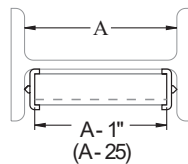

W/100 pcs: 136 Lbs (61.7 kg)

**P3088**

COLUMN INSERT

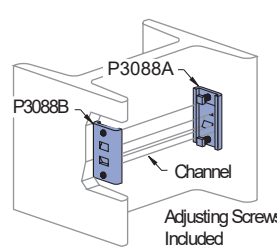

Channel Part Number	Design Pull Out Load Lbs (kN)	Design Slip Load Lbs (kN)
P3300	1,000 4.45	800 3.56
P4100	700 3.11	500 2.22
P4000	500 2.22	300 1.33

Safety factor of 3.

- Adjusting Screws Included.
- Unistrut channel not included.
- Part number P3088 consists of:
  - (1) piece P3088A,
  - (1) piece P3088B and
  - (2) set screws, 3/8" Dia.

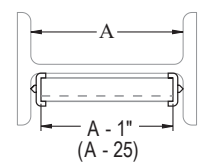

W/100 pcs: 120 Lbs (54.4 kg)

Note: When used for mechanical supports, load capacities of brackets, fittings and other supporting elements should be in compliance with the American Standard Code for Pressure Piping. Clamps are designed to be used with W, M, S & HP Shape beams, Standard C & Misc. MC Channels, Angles & Structural Tees. Clamps must be used in pairs where indicated. For beam clamps with HG finish, standard hardware is EG finish. For optional stainless steel hardware, please contact the factory for availability.

**Beam Clamps**

**PFL050T**

**FLANGE CLAMP**

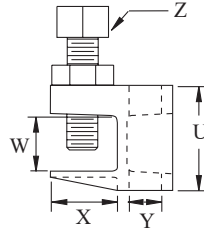
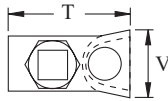
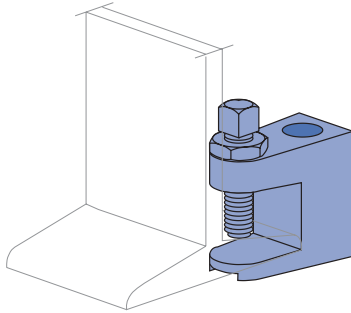

Safety Factor: 4

Part Number	Type of Hole	Rod Size	"Z" Set Screw Size	Wt/100 pcs Lbs (kg)	Max. Allowable Load Lbs (kN)
PFL050	Clear	1/2"	3/8"	40 (18.1)	700 (3.11)
PFL050T	Tapped	1/2"	3/8"	40 (18.1)	700 (3.11)

Material: Malleable Iron.

Cup point set screw and lock nut included.

Set Screw Torque = 6 Ft-Lb  
Lock Nut Torque = 16 Ft-Lb

Part Number	Dimensions					
	"T" In (mm)	"U" In (mm)	"V" In (mm)	"W" In (mm)	"X" In (mm)	"Y" In (mm)
PFL050	2 50.8	1 23/32 43.7	1 25.4	29/32 23.0	1 1/32 27.8	9/16 14.3
PFL050T	2 50.8	1 23/32 43.7	1 25.4	29/32 23.0	1 1/32 27.8	1/2 Tapped Hole

**PLF3075**

**FLANGE CLAMP**

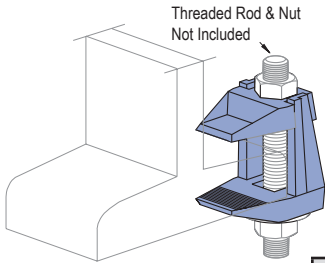

Threaded Rod & Nut  
Not Included

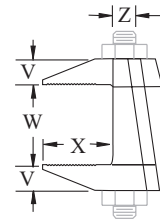
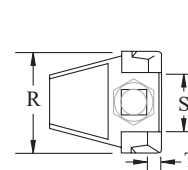

Safety Factor: 4

Material: Malleable Iron.

Part Number	Rod Size	Wt/100 pcs Lbs (kg)	Max. Allowable Load Lbs (kN)	Torque Ft-Lbs
PLF3050	1/2"	91 41	450 2.00	29
PLF3062	5/8"	186 84	900 4.00	69
PLF3075	3/4"	334 152	1,350 6.01	130

Part Number	Dimensions					
	"X" In (mm)	"W" In (mm)	"V" In (mm)	"T" In (mm)	"R" In (mm)	"S" In (mm)
PLF3050	1 3/8 34.9	0 - 1 1/16 0 - 39.7	1/2 12.7	1 1/32 8.7	1 5/16 49.2	1 1/32 29.4
PLF3062	1 13/16 46.0	0 - 2 3/16 0 - 55.6	5/8 15.9	1/2 12.7	2 1/32 59.5	1 1/16 36.5
PLF3075	2 3/16 55.6	0 - 1 3/4 0 - 44.5	3/4 19.1	5/8 15.9	3 76.2	1 3/4 44.5

**PLF9037 THRU PLF9100**

**FLANGE CLAMP**

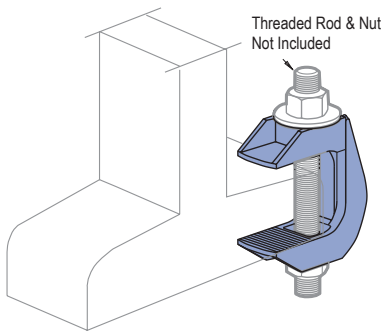

Threaded Rod & Nut  
Not Included

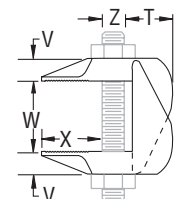
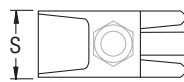

Part Number	Rod Size	Wt/100 pcs Lbs (kg)	Max. Allowable Load Lbs (kN)	Torque Ft-Lbs	"X"	"W"	"V"	"T"	"S"
					In (mm)	In (mm)	In (mm)	In (mm)	In (mm)
PLF9037	3/8"	55 24.9	440 1.96	15	1 25.4	3/4 - 1 1/16 19.1 - 42.9	1/2 12.7	3/4 19.1	1 25.4
PLF9050	1/2"	122 55.3	630 2.80	29	1 1/8 34.9	1 - 2 3/8 25.4 - 60.3	2 1/32 16.7	1 5/16 23.8	1 3/16 30.2
PLF9062	5/8"	200 90.7	1,260 5.60	69	1 1/16 42.9	1 1/8 - 2 3/4 28.6 - 69.9	1 3/16 20.6	1 1/8 28.6	1 3/8 34.9
PLF9075	3/4"	367 166.5	1,880 8.36	131	2 50.8	1 1/4 - 3 1/4 31.8 - 82.6	1 25.4	1 3/8 34.9	1 3/4 44.5
PLF9100	1"	1,101 499.4	3,150 14.01	173	3 76.2	1 3/4 - 3 3/4 44.9 - 95.3	1 1/2 38.1	2 3/16 55.6	2 1/2 63.5

Material: Malleable Iron.

Safety Factor: 4

Note: When used for mechanical supports, load capacities of brackets, fittings and other supporting elements should be in compliance with the American Standard Code for Pressure Piping. Clamps are designed to be used with W, M, S & HP Shape beams, Standard C & Misc. MC Channels, Angles & Structural Tees. Clamps must be used in pairs where indicated. For beam clamps with HG finish, standard hardware is EG finish. For optional stainless steel hardware, please contact the factory for availability.



1 1/8" Channel

Telestrut

Nuts & Hardware

General Fittings

Pipe/Conduit Supports

Electrical Fittings

Concrete Inserts

Solar

Unipier®

**P1834 CHANNEL TROLLEY SUPPORT**

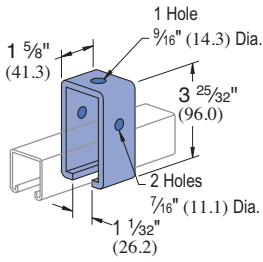

Requires 3/8" x 2 1/2" Bolt and 3/8" Nut (not included)

<b>Design Load</b>
1200 Lbs (5.34 kN)

Wt/100 pcs: 102 Lbs (46.3 kg)

**P1834A CHANNEL TROLLEY SUPPORT**

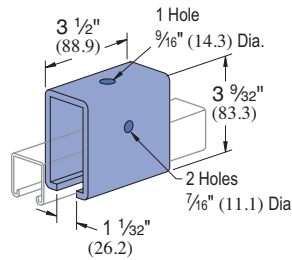

Requires 3/8" x 2 1/2" Bolt and 3/8" Nut (not included)

<b>Design Load</b>
2500 Lbs (11.12 kN)

Wt/100 pcs: 220 Lbs (99.8 kg)

**P2749, P2749N†**

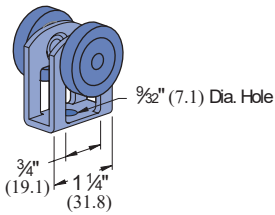

Clevis Material: 12 gauge.

\*Wheel bearings are stainless steel, and should not be lubricated.

† "N" indicates acetal wheels.

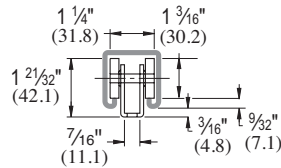

Part Number	Design Load Lbs (kN)	Wt/100 pcs Lbs (kg)
P2749	50 .22	21 9.5
P2749N	10 .04	13 5.9

**P2751, P2751 N†**

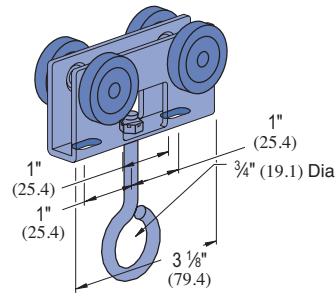

Clevis Material: 12 gauge.

\*Wheel bearings are stainless steel, and should not be lubricated.

† "N" indicates acetal wheels.

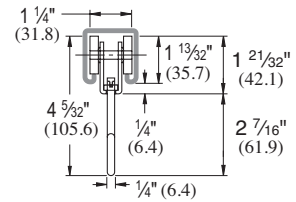

Part Number	Design Load Lbs (kN)	Wt/100 pcs Lbs (kg)
P2751	100 .44	63 28.6
P2751N	20 .09	40 18.1

**P2750, P2750N†**

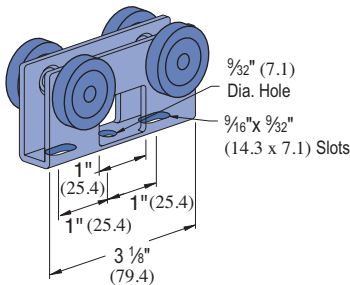

Clevis Material: 12 gauge.

\*Wheel bearings are stainless steel, and should not be lubricated.

† "N" indicates acetal wheels.

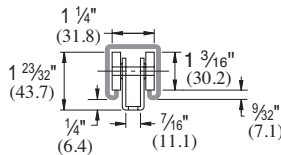

Part Number	Design Load Lbs (kN)	Wt/100 pcs Lbs (kg)
P2750	100 .44	55 24.9
P2750N	20 .09	32 14.5

**P2950**

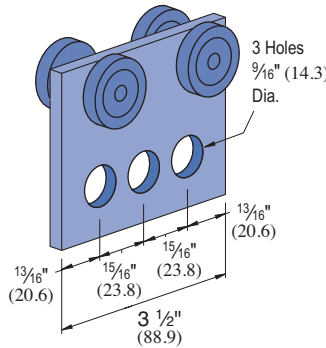

Wheel bearings are stainless steel. Do not lubricate.

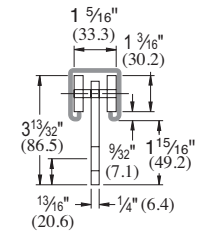

Design Load In P1000		
FPM	RPM	Lbs (kN)
180	600	300
90	300	450
30	100	600
		2.67

**P2949**

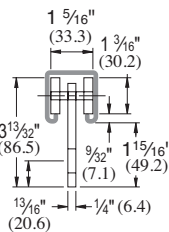
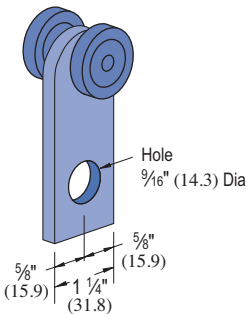

Design Load In P1000		
FPM	RPM	Lbs (kN)
180	600	150
		.67
90	300	225
		1.00
30	100	437
		1.94

Wheel bearings are stainless steel. Do not lubricate.

Wt/100 pcs: 46 Lbs (20.9 kg)

Wt/100 pcs: 110 Lbs (49.9 kg)

Standard Dimensions for 1 1/8" (41.3mm) width series channel fittings (Unless Otherwise Shown on Drawing)

Hole Diameter: 9/16" (14.3mm); Hole Spacing - From End: 1/16" (20.6mm); Hole Spacing - On Center: 1 1/8" (47.6mm); Width: 1 1/8" (41.3mm); Thickness: 1/4" (6.4mm) with steel meeting or exceeding ASTM A1011 SS GR 33, or 0.220" (5.6mm) with steel meeting or exceeding ASTM A1011 HSLAS GR 45

**Special Application Fittings**

**P2354 R-L, P2355 R-L**

**REEL RACK SUPPORTS FOR 1 1/4" & 2" PIPE**

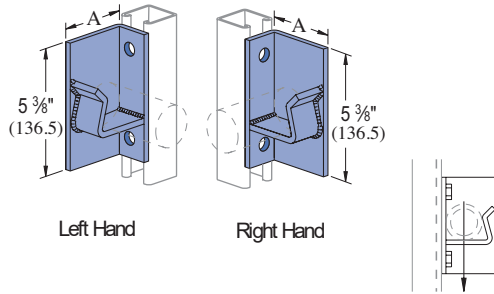

Vertical Channel Part No.	Gauge	Max. Allowable Load Lbs (kN)
P1000	12	3,000 (13.34)
P1100	14	2,000 (8.90)
P2000	16	2,000 (8.90)

Part Number	"A" In (mm)	Std. Pipe Size In (mm)	W/100 pcs Lbs (kg)
P2354 R-L	3	1 1/4	220
	76.2	31.8	99.8
P2355 R-L	3 3/8	2	252
	92.1	50.8	114.3

**P1204 THRU P1208**

**WALL LADDER BRACKET**

**P2454**

**DOUBLE PIPE AXLE SUPPORT**

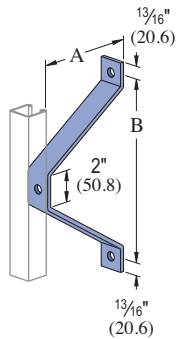

Part Number	"A" In (mm)	"B" In (mm)	W/100 pcs Lbs (kg)
P1204	2 3/8	6	113
	60.3	152.4	51.3
P1205	4 3/8	8	164
	111.1	203.2	74.4
P1206	6 3/8	10	216
	161.9	254.0	98.0
P1207	8 3/8	12	267
	212.7	304.8	121.1
P1208	10 3/8	14	318
	263.5	355.6	144.2

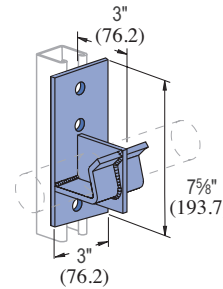

Load Rating 4,000 Lbs (17.79 kN)  
For 1 1/4" (31.8) Standard Pipe

W/100 pcs: 310 Lbs (140.6 kg)

**P1201, P1202, P1203**

**LADDER RUNG**

**P2470-50, -75, -100**

**PIPE COUPLING FITTING**

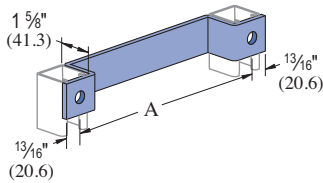

Part Number	"A" In (mm)	W/100 pcs Lbs (kg)
P1201	12	186
	304.8	84.4
P1202	15	221
	381.0	100.2
P1203	18	254
	457.2	115.2

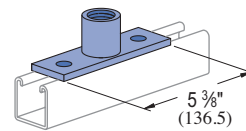

Pipe Coupling		
Part Number	Size In	W/100 pcs Lbs (kg)
P2470-50	1/2	77 (34.9)
P2470-75	3/4	93 (42.2)
P2470-100	1	103 (46.7)

**P1944**

**45° (.25π) STAIR TREAD SUPPORT**

**P2655**

**37 1/2° (.21π) STAIR TREAD SUPPORT**

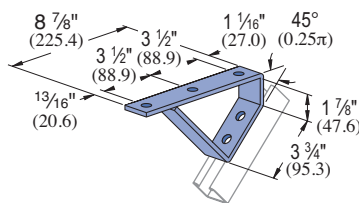

W/100 pcs: 220 Lbs (99.8 kg)

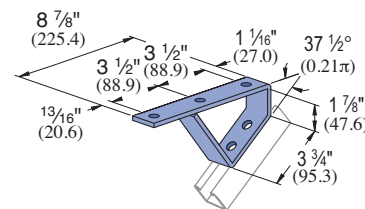

W/100 pcs: 213 Lbs (96.6 kg)

Standard Dimensions for 1 5/8" (41.3mm) width series channel fittings (Unless Otherwise Shown on Drawing)

Hole Diameter: 3/16" (14.3mm); Hole Spacing - From End: 13/16" (20.6mm); Hole Spacing - On Center: 1 7/8" (47.6mm); Width: 1 5/8" (41.3mm); Thickness: 1/4" (6.4mm) with steel meeting or exceeding ASTM A1011 SS GR 33, or 0.220" (5.6mm) with steel meeting or exceeding ASTM A1011 HSLAS GR 45



1 1/8" Channel

Telestrut

Nuts & Hardware

General Fittings

Pipe/Conduit Supports

Electrical Fittings

Concrete Inserts

Solar

Unipier®

**P1843** ADJ. HINGE CONNECTION **EG GR**

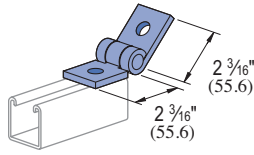

W/100 pcs: 68 Lbs (30.8 kg)

**P1354A** ADJ. HINGE CONNECTION **EG GR**

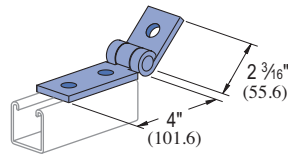

W/100 pcs: 89 Lbs (40.4 kg)

**P1354** ADJ. HINGE CONNECTION **EG GR**

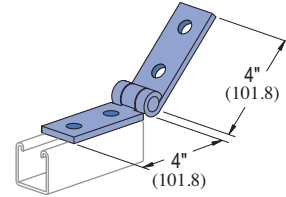

W/100 pcs: 109 Lbs (49.4 kg)

**SPF® 100**

**SEISMIC PIVOT FITTINGS**

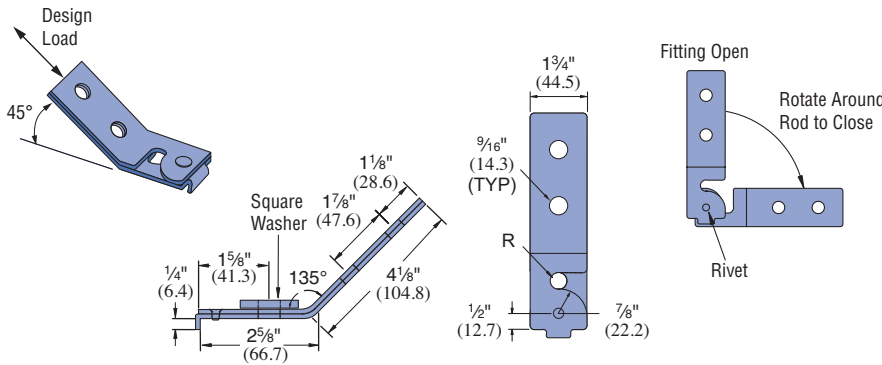

Part Number	Rod Size In (mm)	"R" - Hole Diameter In (mm)	Design Load Lbs (KN)
SPF 100-037	3/8 9.5	7/16 11.1	1,400 6.23
SPF 100-050	1/2 12.7	9/16 14.3	2,100 9.34
SPF 100-062	5/8 15.9	1 1/16 17.5	2,100 9.34
SPF 100-075	3/4 19.1	1 3/16 20.6	2,400 10.68

Safety Factor = 3  
FINISH  
Electro-galvanized (EG), conforming to ASTM B633 Type III SC1.

Notes:

1. Design load is limited to slip capacity of a channel nut at hole "R".
2. Allowable loads have been determined by the manufacturers testing, analysis and technical specifications.
3. For retrofit application, engineer of record must verify.
4. Square washer provided with fitting.
5. When a hanger rod is thru-bolted (in lieu of channel nut installation), higher transverse loads may be transmitted due to the higher allowed rod shear loads compared to channel nut slip values. This higher load may be used with verification through engineering calculations.

**SPF® 200**

**ADJUSTABLE SEISMIC PIVOT FITTINGS**

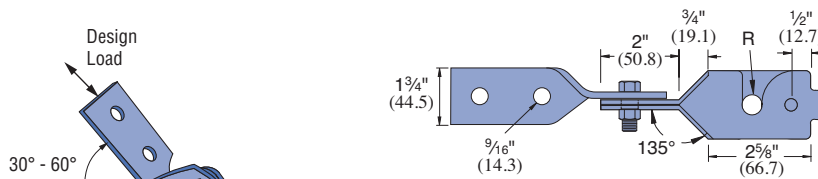

FINISH  
Electro-galvanized (EG), conforming to ASTM B633 Type III SC1.

Part Number	Rod Size In (mm)	"R" - Hole Diameter In (mm)	Design Load Lbs (KN)
SPF 200-037	3/8 9.5	7/16 11.1	1,400 6.23
SPF 200-050	1/2 12.7	9/16 14.3	2,100 9.34
SPF 200-062	5/8 15.9	1 1/16 17.5	2,100 9.34
SPF 200-075	3/4 19.1	1 3/16 20.6	2,400 10.68

Safety Factor = 3.0

Notes:

1. Design load is limited to slip capacity of a channel nut at hole "R".
2. Allowable loads have been determined by the manufacturers testing, analysis and technical specifications at 45° from horizontal.
3. For retrofit application, engineer of record must verify.
4. Square washer provided with fitting.
5. When a hanger rod is thru-bolted (in lieu of channel nut installation), higher transverse loads may be transmitted due to the higher allowed rod shear loads compared to channel nut slip values. This higher load may be used with verification through engineering calculations.

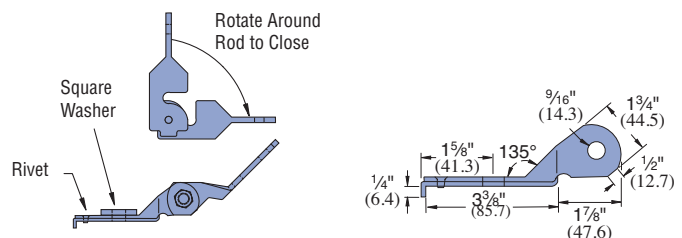



SPF® 300

SEISMIC PIVOT FITTINGS

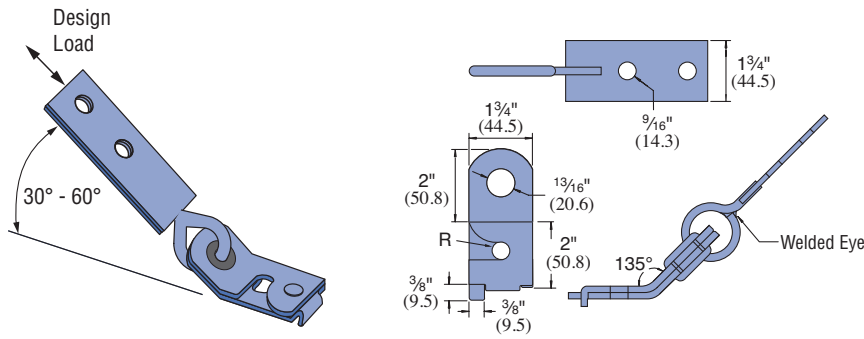

Part Number	Rod Size In (mm)	"R" - Hole Diameter In (mm)	Design Load Lbs (kN)
SPF 300-037	3/8 (9.5)	7/16 (11.1)	1,400 (6.23)
SPF 300-050	1/2 (12.7)	9/16 (14.3)	2,100 (9.34)
SPF 300-062	5/8 (15.9)	1 1/16 (17.5)	2,100 (9.34)
SPF 300-075	3/4 (19.1)	1 3/16 (20.6)	2,400 (10.68)

Safety Factor = 3.0  
 FINISH  
 Electro-galvanized (EG), conforming to ASTM B633 Type III SC1.

Notes:

1. Design load is limited to slip capacity of a channel nut at hole "R".
2. Allowable loads have been determined by the manufacturers testing, analysis and technical specifications at 45° from horizontal.
3. For retrofit application, engineer of record must verify.
4. Square washer provided with fitting.
5. When a hanger rod is thru-bolted (in lieu of channel nut installation), higher transverse loads may be transmitted due to the higher allowed rod shear loads compared to channel nut slip values. This higher load may be used with verification through engineering calculations.



SPF® 400

SEISMIC PIVOT FITTINGS

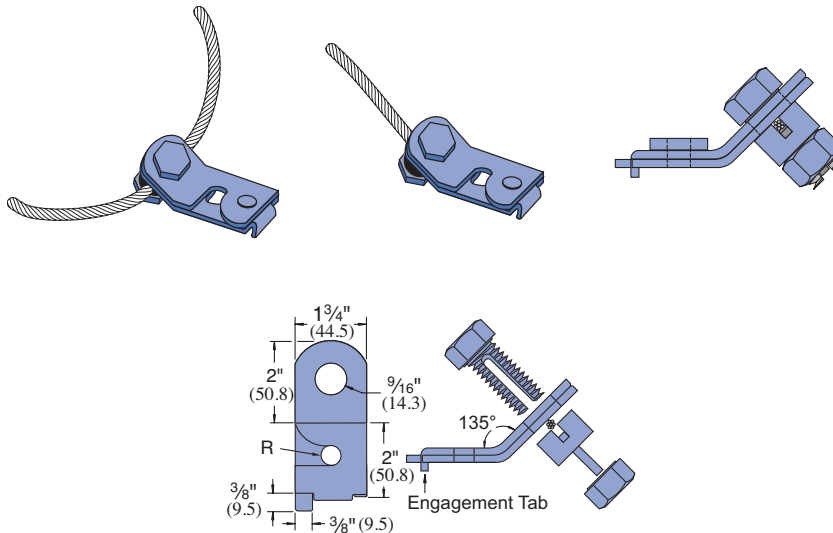

Part Number	Rod Size In (mm)	"R" - Hole Diameter In (mm)
SPF 400-037	3/8 (9.5)	7/16 (11.1)
SPF 400-050	1/2 (12.7)	9/16 (14.3)
SPF 400-062	5/8 (15.9)	1 1/16 (17.5)
SPF 400-075	3/4 (19.1)	1 3/16 (20.6)

FINISH  
 Electro-galvanized (EG), conforming to ASTM B633 Type III SC1.

Wire Rope Diameter In (mm)	Horizontal Design Load		
	4-Way Splayed		Single Cable Transverse
	Transverse lbs (kN)	Longitudinal lbs (kN)	lbs (kN)
3/16	1050	1116	650
4.8	4.67	4.96	2.89

Notes:

1. Allowable loads have been determined by the manufacturers testing, analysis and technical specifications.
2. Galvanized wire rope, 7 x 19 IWSC, RHRL (Prestretched).
3. Torque on nut/spacer: 50 ft-lbs.
4. Safety Factor of 3 for prestretched cable..

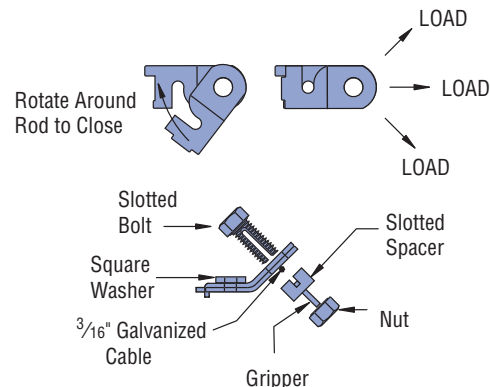



**SEISMIC PIVOT FITTINGS**

**LS 410**

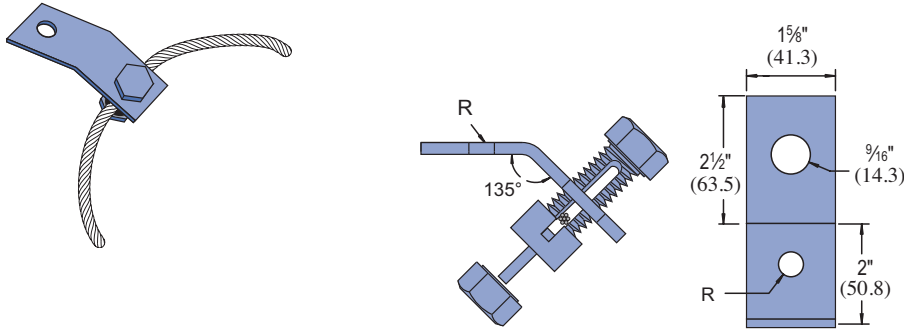

Part Number	Anchor Size In (mm)	"R" - Hole Diameter In (mm)
LS 410-037	3/8 9.5	7/16 11.1
LS 410-050	1/2 12.7	9/16 14.3
LS 410-062	5/8 15.9	1 1/16 17.5
LS 410-075	3/4 19.1	1 3/16 20.6

**FINISH**  
Electro-galvanized (EG), conforming to ASTM B633 Type III SC1.

- Note:
1. Allowable loads have been determined by the manufacturers testing, analysis and technical specifications.
  2. For retrofit application, engineer of record must verify.
  3. Torque on nut/spacer: 50 ft-lbs.
  4. Square washer provided with fitting.
  5. Loads are the same as the SPF 400

**LS 500**

**SEISMIC PIVOT FITTINGS**

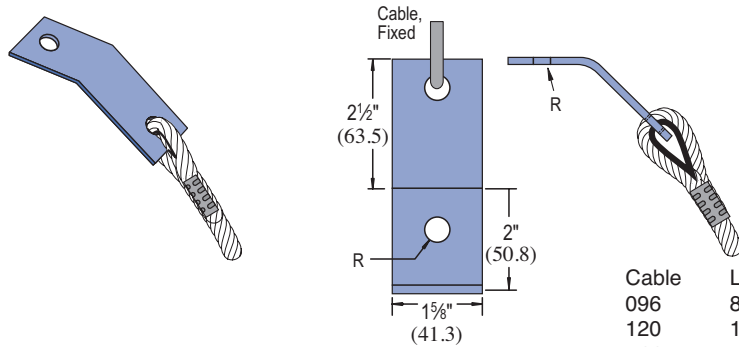

Cable	Length
096	8' (2.4M)
120	10' (3.0M)
144	12' (3.6M)
180	15' (4.5M)
240	20' (6.1M)
300	25' (7.6M)
360	30' (9.1M)
480	40' (12.2M)

**Example**  
LS500-037-096

┌ Cable Length  
├ Anchor Size  
└ Fitting Number

Part Number	Anchor Size In (mm)	"R" - Hole Diameter In (mm)
LS 500-037	3/8 9.5	7/16 11.1
LS 500-050	1/2 12.7	9/16 14.3
LS 500-062	5/8 15.9	1 1/16 17.5
LS 500-075	3/4 19.1	1 3/16 20.6

**FINISH**  
Electro-galvanized (EG), conforming to ASTM B633 Type III SC1.

- Note:
1. Allowable loads have been determined by the manufacturers testing, analysis and technical specifications.
  2. For retrofit application, engineer of record must verify.
  3. Square washer provided with fitting.
  4. Loads are the same as the SPF 400

# PIPE/CONDUIT SUPPORTS

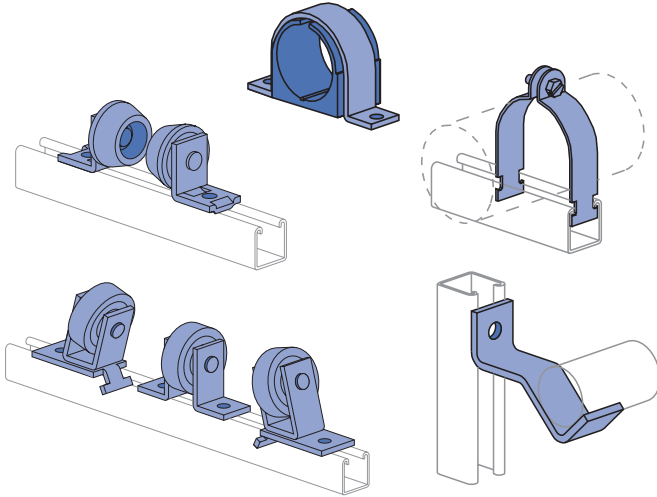

Pipe/Conduit Clamps .....	108 - 111
Unicushion® .....	112
Pipe & Tubing (Cush-A-Clamp®) Clamps .....	113 - 115
Pipe & Tubing (Cush-A-Grip® & Cush-A-Therm™) Clamps.....	116
Pipe Hangers .....	117
Pipe Rollers.....	117 - 119
Pipe Brackets .....	119
Reference Tables .....	120 - 126

## MATERIAL

Unistrut pipe clamps, unless noted, are punch-press made from hot-rolled, pickled and oiled steel plates, strip, bar or coil, and conform to one or more of the following specifications: ASTM A1008, A575, A576, A635, A1011 SS GR 33, A1011 HSLAS GR 45, A1046 or A36. The fitting steel also meets the or exceeds the physical properties of ASTM A1011 GR 33. The pickling of the steel produces a smooth surface free from scale.

Many items are also available in stainless steel, aluminum and fiberglass.

Consult factory for ordering information.

## FINISHES

Pipe supports are available in:

- Electro-galvanized (EG), conforming to ASTM B633 Type III SC1
- Hot-dipped galvanized (HG), conforming to ASTM A123 or A153 (hardware)
- Green Powder Coat (GR), conforming to commercial standards for Powder Coating, and plain (PL)
- Unistrut Defender (DF), conforming to ASTM A1059 or A1046

## APPLICATION

Unistrut pipe clamps, pipe hangers, brackets and rollers are designed for the support of electrical and mechanical services. Supports to meet nearly every requirement can be attained using Unistrut Metal Framing components.

## DIMENSIONS

Imperial dimensions are illustrated in inches. Metric dimensions are shown in parenthesis or as noted. Unless noted, all metric dimensions are in millimeters and rounded to one decimal place.

## DESIGN BOLT TORQUE

BOLT SIZE	¼"-20	⅝"-18	¾"-16	½"-13	⅝"-11	¾"-10
Rec. Torque Ft/Lbs (N•m)	6 (8)	11 (15)	19 (26)	50 (68)	100 (136)	125 (170)
Max Torque Ft/Lbs (N•m)	7 (9)	15 (20)	25 (34)	70 (95)	125 (170)	135 (183)

Note: When tightening ¼" screws used with a two piece pipe clamp, a torque of 5 foot pounds (60 inch-pounds) should be used.

## DESIGN LOAD

Design load data, where shown, is based on the ultimate strength of the connection with a safety factor of 5.0, unless otherwise noted.

When used for mechanical supports, load capacities of brackets, fittings and other supporting elements should be in compliance with the American Standard Code for Pressure Piping.

**Pipe Clamps In Special Materials (P1109, P1211, P1425, P2024 Series)**

Material/Finish	Part Number Suffix	Pipe Clamp Material / Finish	Fasteners (Screw & Nut) Material / Finish	Example
Electro-galvanized	EG	EG	EG	P1109 EG
Hot-dipped galvanized	HG	HG	SS	P1109 HG
Unistrut Defender	DF	DF	DF	P1109 DF
Stainless Steel Type 304	SS	SS	SS	P1109 SS
Stainless Steel Type 316	ST	ST	SS	P1109 ST
Aluminum	AL	AL	AL	P1109 AL
Copper Coated	CC	CC	CC	P1109 CC
Everdur	E EG	EG	E	P1109E EG



1 1/8" Channel

Telestrut

Nuts & Hardware

General Fittings

Pipe/Conduit Supports

Electrical Fittings

Concrete Inserts

Solar

Unipier®

**Pipe & Conduit Clamps**

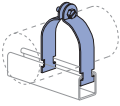

P1109 - Pg 108

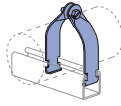

P1211 - Pg 109

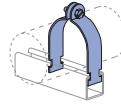

P1425 - Pg 109

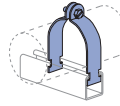

P2024 - Pg 110

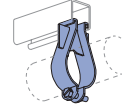

P1563 - Pg 109

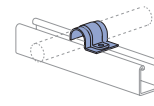

P2008 - Pg 109

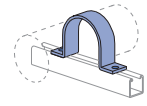

P2558 - Pg 110

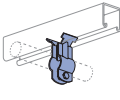

P3409 - Pg 111

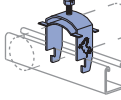

MU025 - Pg 111

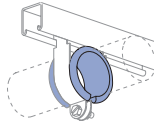

P2600 - Pg 112

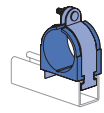

004T008 - Pg 113

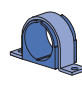

004M007 - Pg 114

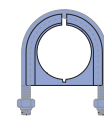

UB1/2PA - Pg 115

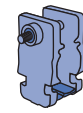

OG-10 - Pg 116

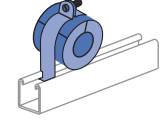

PUX3834 - Pg 116

**Pipe Rollers**

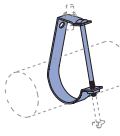

J1205 - Pg 117

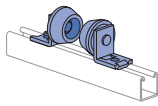

P2474 - Pg 117

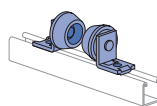

P2474-1 - Pg 118

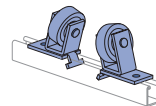

P2475 - Pg 118

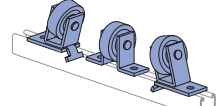

P2476 - Pg 119

**Pipe Brackets**

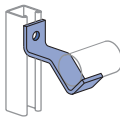

P2481 - Pg 119

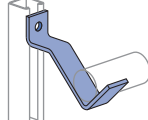

P2482 - Pg 119

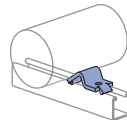

P2243 - Pg 119

**P1109 THRU P1126**

**PIPE CLAMPS FOR RIGID STEEL CONDUIT**

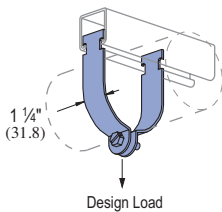

Part No.	Conduit Size In	O.D. Size In (mm)	Thickness Gauge (mm)	Wt/100 pcs Lbs (kg)	Design Load Lbs (kN)
P1109	3/8	0.675 17.1	16 1.5	10 4.5	400 1.78
P1111	1/2	0.840 21.3	16 1.5	11 5.0	400 1.78
P1112	3/4	1.050 26.7	14 1.9	15 6.8	600 2.67
P1113	1	1.315 33.4	14 1.9	17 7.7	600 2.67
P1114	1 1/4	1.660 42.2	14 1.9	19 8.6	600 2.67
P1115	1 1/2	1.900 48.3	12 2.7	29 13.2	800 3.56
P1117	2	2.375 60.3	12 2.7	34 15.4	800 3.56

Part No.	Conduit Size In	O.D. Size In (mm)	Thickness Gauge (mm)	Wt/100 pcs Lbs (kg)	Design Load Lbs (kN)
P1118	2 1/2	2.875 73.0	12 2.7	40 18.1	800 3.56
P1119	3	3.500 88.9	12 2.7	47 21.3	800 3.56
P1120	3 1/2	4.000 101.6	11 3.0	62 28.1	1,000 4.45
P1121	4	4.500 114.3	11 3.0	67 30.4	1,000 4.45
P1123	5	5.563 141.3	11 3.0	80 36.3	1,000 4.45
P1124	6	6.625 168.3	10 3.4	102 46.3	1,000 4.45
P1126	8	8.625 219.1	10 3.4	130 59.0	1,000 4.45

Slotted hex head screw and nut included

**Pipe & Conduit Clamps**

**P1425 THRU P1431**

**PIPE CLAMPS FOR THIN WALL CONDUIT (E.M.T.)**

DF EG HG

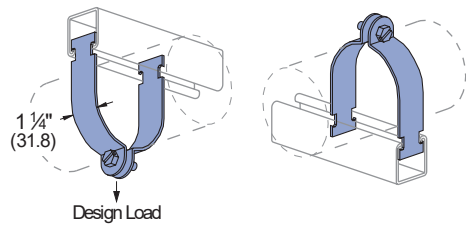

Slotted hex head screw and nut included

Part No.	Conduit Size In (mm)	O.D. Size In (mm)	Thickness Gauge (mm)	Wt/100 pcs Lbs (kg)	Design Load Lbs (kN)
P1425	3/8 9.5	0.577 14.7	16 1.5	9 4.1	400 1.78
P1426	1/2 12.7	0.706 17.9	16 1.5	11 5.0	400 1.78
P1427	3/4 19.1	0.922 23.4	16 1.5	12 5.4	400 1.78
P1428	1 25.4	1.163 29.5	14 1.9	15 6.8	600 2.67
P1429	1 1/4 31.8	1.510 38.4	14 1.9	18 8.2	600 2.67
P1430	1 1/2 38.1	1.740 44.2	12 2.7	29 13.2	800 3.56
P1431	2 50.8	2.197 55.8	12 2.7	33 15.0	800 3.56
P1118	2 1/2 63.5	2.875 73.0	12 2.7	40 18.1	800 3.56
P1119	3 76.2	3.500 88.9	12 2.7	47 21.3	800 3.56
P1120	3 1/2 88.9	4.000 101.6	11 3.0	62 28.1	1,000 4.45
P1121	4 101.6	4.500 114.3	11 3.0	67 30.4	1,000 4.45

**P1211 THRU P1217**

**UNIVERSAL CLAMPS FOR RIGID OR THINWALL CONDUIT**

DF EG HG

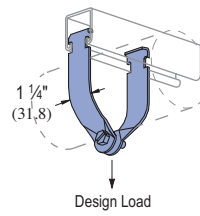

Design Load

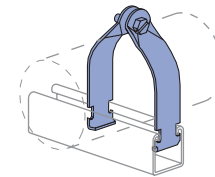

Slotted hex head screw and nut included

Part No.	Conduit Size In (mm)	Thickness Gauge (mm)	Wt/100 pcs Lbs (kg)	Design Load Lbs (kN)
P1211	1/2 12.7	16 1.5	10 4.5	400 1.78
P1212	3/4 19.1	16 1.5	11 5.0	400 1.78
P1213	1 25.4	16 1.5	12 5.4	400 1.78
P1214	1 1/4 31.8	14 1.9	18 8.2	600 2.67
P1215	1 1/2 38.1	14 1.9	20 9.1	600 2.67
P1217	2 50.8	14 1.9	22 10.0	600 2.67
P1118	2 1/2 63.5	12 2.7	40 18.1	800 3.56
P1119	3 76.2	12 2.7	47 21.3	800 3.56
P1120	3 1/2 88.9	11 3.0	62 28.1	1,000 4.45
P1121	4 101.6	11 3.0	67 30.4	1,000 4.45

**P1563 THRU P1573**

**PARALLEL CLAMPS FOR RIGID CONDUIT AND PIPE**

EG

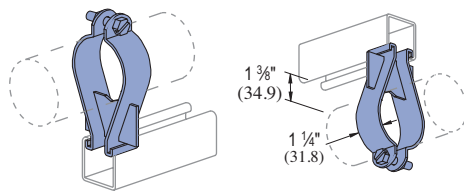

Slotted hex head screw and nut included.

Finish: Electro-galvanized.

Part No.	Pipe Size In (mm)	O.D. Size In (mm)	Thickness Gauge (mm)	Wt/100 pcs Lbs (kg)
P1563	3/8 9.5	0.675 17.1	14 1.9	27 12.2
P1564	1/2 12.7	0.840 21.3	14 1.9	29 13.2
P1565	3/4 19.1	1.050 26.7	14 1.9	30 13.6
P1566	1 25.4	1.315 33.4	14 1.9	31 14.1
P1567	1 1/4 31.8	1.660 42.2	14 1.9	38 17.2
P1568	1 1/2 38.1	1.900 48.3	12 2.7	40 18.1
P1569	2 50.8	2.375 60.3	12 2.7	47 21.3
P1570	2 1/2 63.5	2.875 73.0	12 2.7	66 29.9
P1571	3 76.2	3.500 88.9	12 2.7	78 35.4
P1572	3 1/2 88.9	4.000 101.6	12 2.7	87 39.5
P1573	4 101.6	4.500 114.3	12 2.7	90 40.8

**P2008 THRU P2020 ONE HOLE CLAMP FOR O.D. TUBING**

EG HG

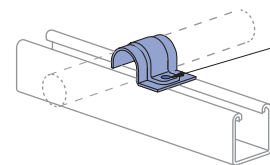

1/4" X 3/4" Round Head Machine Screw and Channel Nut Not Included

Part No.	O.D. Tube Size In (mm)	Thickness Gauge (mm)	Wt/100 pcs Lbs (kg)
P2008	1/4 6.4	16 1.5	4 1.8
P2009	5/16 7.9	16 1.5	5 2.3
P2010	3/8 9.5	16 1.5	5 2.3
P2012	1/2 12.7	16 1.5	6 2.7
P2014	5/8 15.9	14 1.9	8 3.6
P2016	3/4 19.1	14 1.9	9 4.1
P2018	7/8 22.2	14 1.9	10 4.5
P2020	1 25.4	14 1.9	11 5.0

1 1/8" Channel  
Telestrut  
Nuts & Hardware  
General Fittings  
Pipe/Conduit Supports  
Electrical Fittings  
Concrete Inserts  
Solar  
Unipier®



**P2024 THRU P2070-84**

**PIPE CLAMPS FOR O.D. TUBING** EG HG

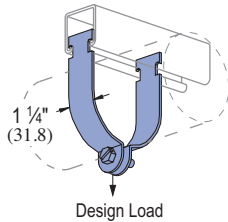
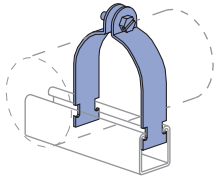

Slotted hex head screw and nut included

- P2024 - P2029 16 ga.
- P2030 - P2035 14 ga.
- P2037 - P2052 12 ga.
- P2053 - P2066 11 ga.
- P2067 - P2070-84 10 ga.

Part Number	O.D. Size In (mm)	Wt/100 pcs Lbs (kg)	Design Load Lbs (kN)
P2024	¼ (6.4)	8 (3.6)	400 (1.78)
P2025	⅜ (9.5)	8 (3.6)	
P2026	½ (12.7)	9 (4.1)	
P2027	⅝ (15.9)	10 (4.5)	
P2028	¾ (19.1)	11 (5.0)	
P2029	7⁄8 (22.2)	12 (5.4)	
P2030	1 (25.4)	14 (6.4)	600 (2.67)
P2031	1⅛ (28.6)	15 (6.8)	
P2032	1¼ (31.8)	16 (7.3)	
P2033	1⅝ (34.9)	17 (7.7)	
P2034	1½ (38.1)	18 (8.2)	
P2035	1⅞ (41.3)	19 (8.6)	
P1430	1¾ (44.5)	29 (13.2)	800 (3.56)
P2037	1⅞ (47.6)	28 (12.7)	
P2038	2 (50.8)	31 (14.1)	
P2039	2ⅈ (54.0)	32 (14.5)	
P2040	2¼ (57.2)	33 (15)	
P1117	2⅝ (60.3)	34 (15.4)	
P2042	2½ (63.5)	35 (15.9)	
P2043	2⅞ (66.7)	37 (16.8)	
P2044	2¾ (69.9)	38 (17.2)	
P1118	2⅞ (73.0)	40 (18.1)	
P2046	3 (76.2)	41 (18.6)	
P2047	3ⅈ (79.4)	43 (19.5)	
P2048	3¼ (82.6)	45 (20.4)	
P2049	3⅝ (85.7)	46 (20.9)	
P1119	3½ (88.9)	47 (21.3)	
P2051	3⅞ (92.1)	56 (25.4)	1000 (4.45)
P2052	3¾ (95.3)	58 (26.3)	
P2053	3⅞ (98.4)	60 (27.2)	
P1120	4 (101.6)	62 (28.1)	
P2055	4ⅈ (104.8)	62 (28.1)	
P2056	4¼ (108.0)	64 (29.0)	
P2057	4⅞ (111.1)	66 (29.9)	
P1121	4½ (114.3)	67 (30.4)	
P2059	4⅞ (117.5)	70 (31.8)	
P2060	4¾ (120.7)	72 (32.7)	

Part Number	O.D. Size In (mm)	Wt/100 pcs Lbs (kg)	Design Load Lbs (kN)
P2061	4⅞ (123.8)	73 (33.1)	1000 (4.45)
P2062	5 (127.0)	74 (33.6)	
P2063	5ⅈ (130.2)	76 (34.5)	
P2064	5¼ (133.4)	77 (34.9)	
P2065	5⅝ (136.5)	78 (35.4)	
P2066	5½ (140.0)	79 (35.8)	
P2067	5⅞ (142.9)	88 (39.9)	
P2068	5¾ (146.1)	90 (40.8)	
P2069	5⅞ (149.2)	92 (41.7)	
P2070	6 (152.4)	94 (42.6)	
P2070-61	6ⅈ (155.6)	96 (43.5)	
P2070-62	6¼ (158.8)	98 (44.5)	
P2070-63	6⅞ (161.9)	99 (44.9)	
P2070-64	6½ (165.1)	100 (45.4)	
P1124	6⅞ (168.3)	102 (46.3)	
P2070-66	6¾ (171.5)	104 (47.2)	
P2070-67	6⅞ (174.6)	106 (48.1)	
P2070-70	7 (177.8)	108 (49.0)	
P2070-71	7ⅈ (181.0)	110 (49.9)	
P2070-72	7¼ (184.2)	112 (50.8)	
P2070-73	7⅞ (187.3)	114 (51.7)	
P2070-74	7½ (190.5)	116 (52.6)	
P2070-75	7⅞ (193.7)	117 (53.1)	
P2070-76	7¾ (196.9)	119 (54.0)	
P2070-77	7⅞ (200.0)	121 (54.9)	
P2070-80	8 (203.2)	123 (55.8)	
P2070-81	8ⅈ (206.4)	125 (56.7)	
P2070-82	8¼ (209.6)	126 (57.2)	
P2070-83	8⅞ (212.7)	128 (58.1)	
P2070-84	8½ (215.9)	129 (58.5)	
P1126	8⅞ (219.1)	130 (59.0)	

**P2558-5 THRU P2558-60**

**SINGLE PIECE PIPE STRAP** EG GR HG

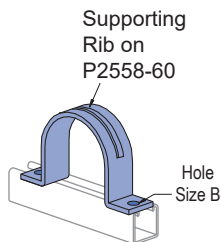
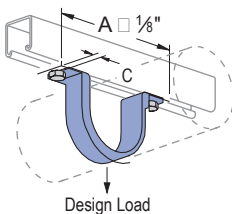

Hardware sold separately.

Part No.	Nom. Pipe Size In	A In (mm)	"B" In (mm)	C In (mm)	Thickness In (mm)	Wt/100 pcs Lbs (kg)	Design Load Lbs (kN)
P2558-05	½	2⅞ 73.0	7.1	11.1	3.2	23 10.4	500 2.22
P2558-07	¾	3⅞ 79.4				26 11.8	
P2558-10	1	3⅞ 85.7				31 14.1	
P2558-12	1¼	3¾ 95.3	35 15.9				
P2558-15	1½	3⅞ 98.4	39 17.7				
P2558-20	2	5¼ 146.1	7⅞ 11.1	1⅞ 17.5	¼ 6.4	94 42.6	
P2558-25	2½	6¼ 158.8				114 51.7	
P2558-30	3	6⅞ 174.6				133 60.3	
P2558-35	3½	7⅞ 187.3				152 68.9	
P2558-40	4	7⅞ 200.0				176 79.8	
P2558-50	5	9 228.6				198 89.8	
P2558-60	6	10 254.0				225 102.1	

**Pipe & Conduit Clamps**

P3409 THRU P3417

STAND-OFF PIPE CLAMPS **EG HG**

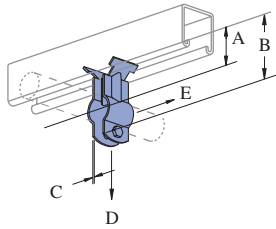

Hardware included.  
Finish: Electro-galvanized.  
Pipe Clamp 1¼" Wide

Part No.	Pipe Size In (mm)	O.D. Size In (mm)	Load "D" Lbs (kN)	Load "E" Lbs (kN)	A In (mm)	B In (mm)	C Gauge (mm)	Wt/100 pcs Lbs (kg)
P3409	¾	0.675	100	25	1⅞	2⅞	14	14
	9.5	17.1	0.44	0.11	28.6	54.0	1.9	6.4
P3411	½	0.840	150	35	1¼	2⅞	14	15
	12.7	21.3	0.67	0.16	31.8	58.7	1.9	6.8
P3412	¾	1.050	175	40	1⅞	2⅞	14	19
	19.1	26.7	0.78	0.18	33.3	63.5	1.9	8.6
P3413	1	1.315	200	50	1½	2¾	14	22
	25.4	33.4	0.89	0.22	38.1	69.9	1.9	10.0
P3414	1¼	1.660	300	70	1⅞	3¼	12	34
	31.8	42.2	1.33	0.31	42.9	82.6	2.7	15.4
P3415	1½	1.900	400	80	1¾	3½	11	49
	38.1	48.3	1.78	0.36	44.5	88.9	3.0	22.2
P3417	2	2.375	500	120	2	4	10	55
	50.8	60.3	2.22	0.53	50.8	101.6	3.4	24.9

Safety factor of 5

MU025 THRU MU400

MUSTANG UNIVERSAL ONE-PIECE PIPE, CONDUIT (GRC, EMT & IMC) AND TUBING CLAMPS **EG**

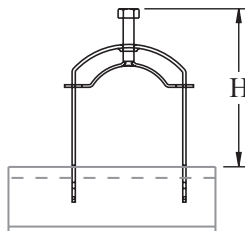
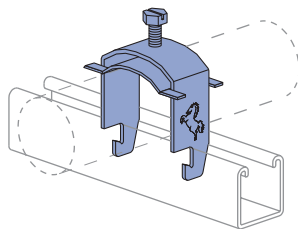

Finish: Electro-galvanized.  
Clamps are 14 ga.

Part No.	Nominal Trade Size	Trade Size O.D.		Height Above Channel "H"	
	In (mm)	Min In (mm)	Max In (mm)	Min In (mm)	Max In (mm)
MU025	¼	0.375	0.5	1¼	2
	6.4	9.5	13.7	44.5	50.8
MU037	¾	0.5	0.7	1⅞	2⅞
	9.5	12.7	17.1	47.6	54.0
MU050	½	0.63	0.84	2	2¼
	12.7	15.9	21.3	50.8	57.2
MU075	¾	0.88	1.05	2¼	2½
	19.1	22.2	26.7	57.2	63.5
MU100	1	1.13	1.32	2⅞	2¾
	25.4	28.6	33.4	60.3	69.9
MU125	1¼	1.38	1.66	2¾	3⅞
	31.8	34.9	42.2	69.9	79.4
MU150	1½	1.63	1.90	3	3⅞
	38.1	41.3	48.3	76.2	85.7
MU200	2	2.13	2.38	3⅞	3⅞
	50.8	54.0	60.3	85.7	98.4
MU250	2½	2.63	2.88	4¼	4⅞
	63.5	66.7	73.0	108.0	117.5
MU300	3	3.13	3.50	4⅞	5⅞
	76.2	79.4	88.9	123.8	136.5
MU350	3½	3.63	4.00	5¼	5⅞
	88.9	92.1	101.6	133.4	149.2
MU400	4	4.13	4.50	5¾	6⅞
	101.6	104.8	114.3	146.1	161.9



**P2600**

**UNICUSHION®: ISOLATION MATERIAL**

W/Carton: 2.5 Lbs (1.1 kg)

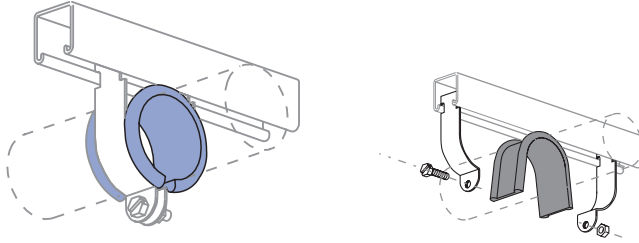

- 25 feet per carton.
- Cut to length as shown in chart below.

**UNICUSHION FEATURES**

- Shock absorption
- Protection from corrosion and abrasion
- Allowance for expansion and contraction in pipe diameter
- Sound and vibration isolation
- Stability in use from - 50° F (-47° C) to + 350°F (+177° C)
- Flexible elastomer material
- Will not support combustion

**UNICUSHION® CLAMP SELECTION GUIDE**

**EMT CONDUIT**

Nominal Size	Use with Clamp	UNICUSHION Length In (mm)
3/8"	P1426	1 1/4 (44.5)
1/2"	P1111	2 1/8 (54.0)
3/4"	P1112	2 3/4 (69.9)
1"	P2032	3 5/8 (92.1)
1 1/4"	P2035	4 3/4 (120.7)
1 1/2"	P2037	5 1/2 (139.7)
2"	P1117	6 3/4 (171.5)

**STANDARD PIPE OR RIGID CONDUIT**

Nominal Size	Use with Clamp	UNICUSHION Length In (mm)
3/8"	P1111	2 1/8 (54.0)
1/2"	P2030	3 (76.2)
3/4"	P2031	3 1/4 (82.6)
1"	P2034	4 1/4 (108.0)
1 1/4"	P2037	5 1/4 (133.4)
1 1/2"	P2038	6 (152.4)
2"	P2042	7 1/2 (190.5)
2 1/2"	P2046	9 (228.6)
3"	P2051	11 (279.4)
3 1/2"	P2055	12 1/4 (311.2)
4"	P2059	14 (355.6)
5"	P2067	17 1/2 (444.5)
6"	P2070-66	20 3/4 (527.1)

**COPPER TUBING TYPE K OR L**

Nominal Size	Use with Clamp	UNICUSHION Length In (mm)
1/4"	P2026	1 1/16 (27.0)
3/8"	P2027	1 1/2 (38.1)
1/2"	P2028	2 1/8 (54.0)
5/8"	P2029	2 1/4 (57.2)
3/4"	P2030	3 (76.2)
1"	P2032	3 5/8 (92.1)
1 1/4"	P2034	4 1/2 (114.3)
1 1/2"	P1430	5 1/4 (133.4)
2"	P2040	6 3/4 (171.5)
2 1/2"	P2044	8 1/4 (209.6)
3"	P2048	10 (254.0)
3 1/2"	P2052	11 1/4 (285.8)
4"	P2056	12 1/2 (317.5)
5"	P2064	16 (406.4)
6"	P2070-62	19 (482.6)
8"	P2070-82	25 (635.0)

**UNICUSHION® CLAMP CUTTING GUIDE**

O. D. Size In (mm)	Use With Clamp	UNICUSHION Length In (mm)
1/4 (6.4)	P2025	7/8 (22.2)
3/8 (9.5)	P2026	1 1/16 (27.0)
1/2 (12.7)	P2027	1 1/2 (38.1)
5/8 (15.9)	P2028	2 1/8 (54.0)
3/4 (19.1)	P2029	2 1/4 (57.2)
7/8 (22.2)	P2030	3 (76.2)
1 (25.4)	P2031	3 1/4 (82.6)
1 1/8 (28.6)	P2032	3 5/8 (92.1)
1 1/4 (31.8)	P2033	4 (101.6)
1 3/8 (34.9)	P2034	4 1/2 (114.3)
1 1/2 (38.1)	P2035	4 3/8 (123.8)
1 3/4 (41.3)	P1430	5 1/4 (133.4)
1 3/4 (44.5)	P2037	5 1/2 (139.7)
1 7/8 (47.6)	P2038	6 (152.4)
2 (50.8)	P2039	6 1/2 (165.1)
2 1/8 (54.0)	P2040	6 3/4 (171.5)
2 1/4 (57.2)	P1117	7 1/4 (184.2)
2 3/8 (60.3)	P2042	7 1/2 (190.5)
2 1/2 (63.5)	P2043	8 (203.2)
2 5/8 (66.7)	P2044	8 1/4 (209.6)
2 3/4 (69.9)	P1118	8 3/4 (222.3)
2 7/8 (73.0)	P2046	9 1/4 (235.0)
3 (76.2)	P2047	9 1/2 (241.3)

O. D. Size In (mm)	Use With Clamp	UNICUSHION Length In (mm)
3/8 (79.4)	P2048	10 (254.0)
3/4 (82.6)	P2049	10 1/2 (266.7)
3 5/8 (85.7)	P1119	10 3/4 (273.1)
3 1/2 (88.9)	P2051	11 (279.4)
3 5/8 (92.1)	P2052	11 1/4 (285.8)
3 3/4 (95.3)	P2053	11 1/2 (292.1)
3 7/8 (98.4)	P1120	11 3/4 (298.5)
4 (101.6)	P2055	12 (304.8)
4 1/8 (104.8)	P2056	12 1/2 (317.5)
4 1/4 (108.0)	P2057	13 (330.2)
4 3/8 (111.1)	P1121	13 1/2 (342.9)
4 1/2 (114.3)	P2059	14 (355.6)
4 5/8 (117.5)	P2060	14 1/4 (362.0)
4 3/4 (120.7)	P2061	14 3/4 (374.7)
4 7/8 (123.8)	P2062	15 (381.0)
5 (127.0)	P2063	15 1/2 (393.7)
5 1/8 (130.2)	P2064	16 (406.4)
5 1/4 (133.4)	P2065	16 1/4 (412.8)
5 3/8 (136.5)	P2066	16 1/2 (419.1)
5 1/2 (139.7)	P2067	17 (431.8)
5 5/8 (142.9)	P2068	17 1/2 (444.5)
5 3/4 (146.1)	P2069	17 3/4 (450.9)
5 7/8 (149.2)	P2070	18 1/4 (463.6)

O. D. Size In (mm)	Use With Clamp	UNICUSHION Length In (mm)
6 (152.4)	P2070-61	18 1/2 (469.9)
6 1/8 (155.6)	P2070-62	19 (482.6)
6 1/4 (158.8)	P2070-63	19 1/4 (489.0)
6 3/8 (161.9)	P2070-64	19 3/4 (501.7)
6 1/2 (165.1)	P1124	20 (508.0)
6 5/8 (168.3)	P2070-66	20 1/2 (520.7)
6 3/4 (171.5)	P2070-67	21 (533.4)
6 7/8 (174.6)	P2070-70	21 1/4 (539.8)
7 (177.8)	P2070-71	21 3/4 (552.5)
7 1/8 (181.0)	P2070-72	22 (558.8)
7 1/4 (184.2)	P2070-73	22 1/2 (571.5)
7 3/8 (187.3)	P2070-74	22 3/4 (577.9)
7 1/2 (190.5)	P2070-75	23 1/4 (590.6)
7 5/8 (193.7)	P2070-76	23 1/2 (596.9)
7 3/4 (196.9)	P2070-77	24 (609.6)
7 7/8 (200.0)	P2070-80	24 1/2 (622.3)
8 (203.2)	P2070-81	24 3/4 (628.7)
8 1/8 (206.4)	P2070-82	25 (635.0)
8 1/4 (209.6)	P2070-83	25 1/2 (647.7)
8 3/8 (212.7)	P2070-84	26 (660.4)
8 1/2 (215.9)	P1126	26 1/4 (666.8)



004T008 THRU 098N106, 009N012 THRU 106N114

CUSH-A-CLAMP® ASSEMBLY

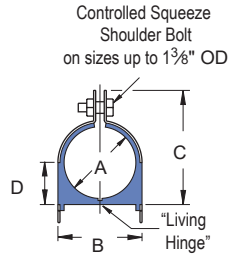
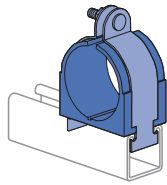

**Materials:**

Clamp: Electro-galvanized or stainless steel.  
Cushion: Thermoplastic elastomer. (UV Resistant)

Includes cushion, clamp and hardware.

**Temperature Rating:**

-50°F to +275°F (-45°C to +135°C)

Insert Width: 1.56" (39.6)

Part Numbers are "coded" to designate cushion size and clamp size. Examples:

- 004T008 004 - Cushion Size 1/16" (6.4)  
T - With Controlled Squeeze Shoulder Bolt  
Available on sizes up to 1 3/8"
- 008 - Clamp Size 3/16" (12.7)
- 009N012 009 - Cushion Size 3/16" (14.3)  
N - With Standard Bolt
- 012 - Clamp Size 1/4" (19.1)

**Pipe Series Assembly**

Part No.	Nominal Pipe Size	"A" In(mm)	"B" In(mm)	"C" In(mm)	"D" In(mm)	WV/100 pcs Lbs(kg)
009N012	1/4	0.54	0.98	1.34	0.43	13
		13.7	24.9	34.0	10.9	5.9
011N014	3/8	0.67	1.13	1.54	0.49	14
		17.0	28.7	39.1	12.4	6.4
014N018	1/2	0.84	1.29	1.82	0.58	15
		21.3	32.8	46.2	14.7	6.8
017N022	3/4	1.05	1.5	1.95	0.7	17
		26.7	38.1	49.5	17.8	7.7
021N026	1	1.31	1.76	2.34	0.81	19
		33.3	44.7	59.4	20.6	8.6
027N032	1 1/4	1.66	2.17	2.73	0.99	35
		42.2	55.1	69.3	25.1	15.9
030N034*	1 1/2	1.9	2.35	2.86	1.09	39
		48.3	59.7	72.6	27.7	17.7
038N044	2	2.37	2.82	3.67	1.41	49
		60.2	71.6	93.2	35.8	22.2
046N052	2 1/2	2.87	3.32	4.17	1.66	57
		72.9	84.3	105.9	42.2	25.9
056N062	3	3.5	3.95	4.79	1.97	55
		88.9	100.3	121.7	50.0	24.9
064N072	3 1/2	4	4.45	5.42	2.28	88
		101.6	113.0	137.7	57.9	39.9
072N080	4	4.5	4.95	5.92	2.53	110
		114.3	125.7	150.4	64.3	49.9
089N096	5	5.56	6.01	6.92	3.06	130
		141.2	152.7	175.8	77.7	59.0
106N114	6	6.62	7.07	8.23	3.59	140
		168.1	179.6	209.0	91.2	63.5

**Tube Series Assembly**

Part Number	Copper & Steel Tube O. D. Size	Copper Water Pipe (Nominal)	Dimensions				WV/100 pcs Lbs(kg)
			"A" In(mm)	"B" In(mm)	"C" In(mm)	"D" In(mm)	
004T008	1/4		0.25	0.62	0.98	0.27	10
			6.4	15.7	24.9	6.9	4.5
006T010	3/8	1/4	0.37	0.82	1.13	0.33	11
			9.4	20.8	28.7	8.4	5.0
008T012	1/2	3/8	0.5	0.94	1.34	0.4	13
			12.7	23.9	34.0	10.2	5.9
010T014	5/8	1/2	0.62	1.06	1.54	0.46	14
			15.7	26.9	39.1	11.7	6.4
012T016	3/4	5/8	0.75	1.2	1.68	0.52	14
			19.1	30.5	42.7	13.2	6.4
014T018	7/8	3/4	0.87	1.31	1.82	0.58	15
			22.1	33.3	46.2	14.7	6.8
016T020	1		1	1.44	1.95	0.65	17
			25.4	36.6	49.5	16.5	7.7
018T022	1 1/8	1	1.12	1.57	2.08	0.7	18
			28.4	39.9	52.8	17.8	8.2
020T024	1 1/4		1.25	1.7	2.21	0.77	18
			31.8	43.2	56.1	19.6	8.2
022T026	1 3/8	1 1/4	1.37	1.82	2.34	0.83	20
			34.8	46.2	59.4	21.1	9.1
024N028	1 1/2		1.5	1.95	2.47	0.9	33
			38.1	49.5	62.7	22.9	15.0
026N030	1 5/8	1 1/2	1.62	2.07	2.6	0.96	35
			41.1	52.6	66.0	24.4	15.9
028N032	1 3/4		1.75	2.2	2.73	1.02	37
			44.5	55.9	69.3	25.9	16.8
030N034	1 7/8		1.9	2.35	2.86	1.09	39
			48.3	59.7	72.6	27.7	17.7
032N036	2		2	2.45	3.04	1.15	46
			50.8	62.2	77.2	29.2	20.9
034N040	2 1/8	2	2.12	2.57	3.23	1.27	47
			53.8	65.3	82.0	32.3	21.3
038N044	2 1/4		2.37	2.82	3.67	1.41	49
			60.2	71.6	93.2	35.8	22.2
040N046	2 3/8		2.5	2.94	3.79	1.46	51
			63.5	74.7	96.3	37.1	23.1
042N048	2 1/2	2 1/2	2.62	3.1	3.92	1.53	55
			66.5	78.0	99.6	38.9	24.9
046N052	2 7/8		2.87	3.3	4.17	1.66	57
			72.9	84.3	105.9	42.2	25.9
050N054	3		3	3.6	4.42	1.78	60
			76.2	90.7	112.3	45.2	27.2
050N056	3 1/8	3	3.12	3.6	4.42	1.78	60
			79.2	90.7	112.3	45.2	27.2
053N060	3 1/4		3.31	4.0	4.75	1.9	62
			84.1	100.6	120.7	48.3	28.1
056N062	3 1/2		3.5	4.0	4.79	1.97	55
			88.9	100.3	121.7	50.0	24.9
058N064	3 3/8	3 1/2	3.62	4.2	4.99	2.03	70
			91.9	106.7	126.7	51.6	31.8
064N072	4		4	4.5	5.42	2.28	88
			101.6	113.0	137.7	57.9	39.9
066N074	4 1/8	4	4.12	4.6	5.54	2.34	94
			104.6	116.1	140.7	59.4	42.6
069N076	4 1/4		4.34	5.0	5.84	2.4	100
			110.2	126.0	148.3	61.0	45.4
072N080	4 1/2		4.5	5.0	5.92	2.53	110
			114.3	125.7	150.4	64.3	49.9
082N090	5	5	5.12	5.6	6.54	2.84	125
			130.0	141.5	166.1	72.1	56.7
098N106	6	6	6.12	6.6	7.54	3.34	130
			155.4	166.9	191.5	84.8	59.0



1 1/8" Channel

Telestrut

Nuts & Hardware

General Fittings

Pipe/Conduit Supports

Electrical Fittings

Concrete Inserts

Solar

Unipier®

**004M007 THRU 034M040 CUSH-A-CLAMP®**

Assembly Omega Series™

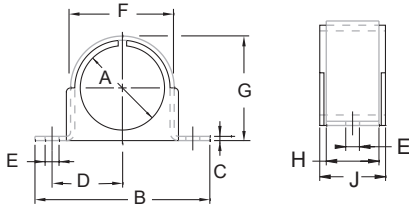
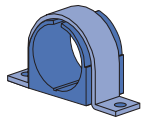

Includes clamp and cushion.

Materials: Clamp: ZD or stainless steel.

Cushion: Thermoplastic elastomer.

Note: 1-1/4 and larger can be used with Unistrut Channel.

**Can be mounted to any flat surface.**

**CUSH-A-CLAW™**

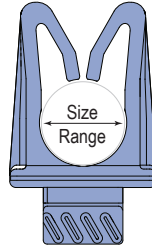

UV standardized thermo plastic

Temp Range: -50° to 275°F

Sure Grip Base

No Fasteners needed

Corrosion resistant

Prevents Galvanic Corrosion - Great for Unistrut® Defender™

Part Number	Size
CL04	1/4"
CL06	3/8"
CL08	1/2"
CL10	5/8"
CL12	3/4"
CL14	7/8"
CL18	1-1/8"

Part Number	Copper & Steel Tubing O. D. In	Copper Water Pipe (Nominal) In	Pipe Size (Nominal) In	Dimensions									Wt/100 pcs Lbs (kg)
				"A" In (mm)	"B" In (mm)	"C" In (mm)	"D" In (mm)	"E" In (mm)	"F" In (mm)	"G" In (mm)	"H" In (mm)	"J" In (mm)	
004M007	1/4			0.25	1.8	0.06	0.6	0	0.53	0.48	0.62	0.78	3.4
				6.4	46.0	1.5	15.2	5.1	13.5	12.2	15.7	19.8	1.5
006M008	3/8	1/4		0.37	1.9	0.06	0.65	0	0.62	0.62	0.62	0.81	4.0
				9.4	48.3	1.5	16.5	5.1	15.7	15.7	15.7	20.6	1.8
008M011	1/2	3/8	1/4	0.5	2.2	0.06	0.8	0	0.82	0.75	0.75	0.98	5.5
				12.7	55.9	1.5	20.3	6.6	20.8	19.1	19.1	24.9	2.5
010M013	5/8	1/2	3/8	0.62	2.3	0.06	0.86	0	0.94	0.87	0.75	0.98	6.0
				15.7	58.9	1.5	21.8	6.6	23.9	22.1	19.1	24.9	2.7
012M015	3/4	5/8		0.75	2.4	0.06	0.9	0	1.03	1.01	0.75	0.98	6.5
				19.1	61.2	1.5	22.9	6.6	26.2	25.7	19.1	24.9	2.9
014M017	7/8	3/4	1/2	0.87	2.6	0.06	0.98	0	1.18	1.03	0.75	0.98	7.1
				22.1	65.0	1.5	24.9	6.6	30.0	26.2	19.1	24.9	3.2
016M019	1			1	2.7	0.06	1.04	0	1.31	1.25	0.75	0.98	7.8
				25.4	68.1	1.5	26.4	6.6	33.3	31.8	19.1	24.9	3.5
018M020			3/4	1.05	2.7	0.06	1.04	0	1.31	1.25	0.75	0.98	8.1
				26.7	68.1	1.5	26.4	6.6	33.3	31.8	19.1	24.9	3.7
018M021	1 1/8	1		1.12	2.8	0.06	1.11	0	1.44	1.33	0.75	0.98	8.4
				28.4	71.6	1.5	28.2	6.6	36.6	33.8	19.1	24.9	3.8
020M024	1 1/4			1.25	3.0	0.08	1.2	0	1.65	1.47	1.25	1.56	17
				31.8	76.2	2.0	30.5	6.6	41.9	37.3	31.8	39.6	7.7
021M026			1	1.31	3.1	0.08	1.26	0	1.76	1.71	1.25	1.56	20
				33.3	79.2	2.0	32.0	6.6	44.7	43.4	31.8	39.6	9.1
022M026	1 3/8	1 1/4		1.37	3.1	0.08	1.26	0	1.76	1.71	1.25	1.56	19
				34.8	79.2	2.0	32.0	6.6	44.7	43.4	31.8	39.6	8.6
024M028	1 1/2			1.5	3.7	0.08	1.42	0	1.93	1.88	1.25	1.56	20
				38.1	92.7	2.0	36.1	6.6	49.0	47.8	31.8	39.6	9.1
026M030	1 5/8	1 1/2		1.62	3.8	0.08	1.48	0	2.07	2	1.25	1.56	23
				41.1	95.8	2.0	37.6	6.6	52.6	50.8	31.8	39.6	10.4
027M032			1 1/4	1.66	3.9	0.1	1.55	0	2.21	2.12	1.25	1.56	32
				42.2	99.1	2.5	39.4	8.4	56.1	53.8	31.8	39.6	14.5
028M032	1 3/4			1.75	3.9	0.1	1.55	0	2.21	2.12	1.25	1.56	32
				44.5	99.1	2.5	39.4	8.4	56.1	53.8	31.8	39.6	14.5
030M034	1 7/8		1 1/2	1.87	4.0	0.1	1.61	0	2.33	2.25	1.25	1.56	34
				47.5	102.1	2.5	40.9	8.4	59.2	57.2	31.8	39.6	15.4
032M036	2			2	4.2	0.1	1.67	0	2.46	2.38	1.25	1.56	36
				50.8	105.4	2.5	42.4	8.4	62.5	60.5	31.8	39.6	16.3
034M040	2 1/8			2.12	4.4	0.1	1.8	0	2.71	2.62	1.25	1.56	41
				53.8	111.8	2.5	45.7	8.4	68.8	66.5	31.8	39.6	18.6
038M044			2	2.37	4.7	0.1	1.94	0	2.96	2.88	1.25	1.56	44
				60.2	119.6	2.5	49.3	8.4	75.2	73.2	31.8	39.6	20.0
082M090	5 1/8		5	5.12	7.6	0.1	3.41	0	5.83	6.75	1.25	1.56	120
				130.0	194.1	2.5	86.6	10.2	148.1	171.5	31.8	39.6	54.4

UB½PA THRU UB12PA

CUSH-A-CLAMP® ASSEMBLY U-BOLT SERIES **LEG**

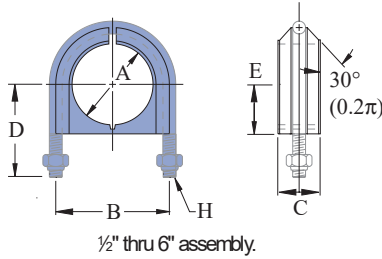

½" thru 6" assembly.

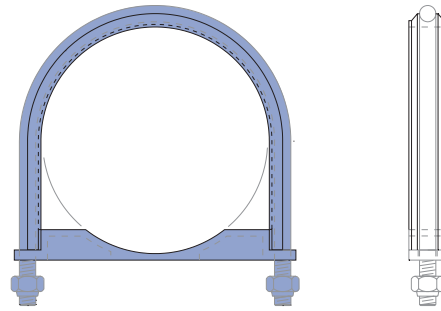

8" thru 12" assembly.

Includes: U bolt, cushion, and hardware.

Materials:

U Bolt: Electro-galvanized finish or Type 316 SS

Cushion: Thermoplastic elastomer.

Note: Not intended for use with metal framing components due to the length of the thread.

Part Number	Pipe Size (Nominal) In (mm)	Dimensions							W/100 pcs Lbs (kg)
		"A" In (mm)	"B" In (mm)	"C" In (mm)	"D" In (mm)	"E" In (mm)	"F" In (mm)	H	
UB1/2PA	½	0.84	1.6	0.68	1.5	1	¼	¼-20 UNC-2B	9
	12.7	21.3	40.6	17.3	38.1	17.0	6.4		4.1
UB3/4PA	¾	1.1	1.8	0.7	1.6	0.8	¼	¼-20 UNC-2B	10
	19.1	26.7	45.7	17.3	40.6	19.8	6.4		4.5
UB1PA	1	1.3	2.1	0.7	1.7	0.9	¼	¼-20 UNC-2B	12
	25.4	33.3	52.1	17.3	43.2	23.1	6.4		5.4
UB1 1/4 PA	1¼	1.7	2.5	1.2	2.1	1.1	⅜	⅜-16 UNC-2B	36
	31.8	42.2	64.5	31.5	53.3	27.4	9.5		16.3
UB1 1/2 PA	1½	1.9	2.8	1.2	2.2	1.2	⅜	⅜-16 UNC-2B	32
	38.1	48.3	70.6	31.5	55.9	30.2	9.5		14.5
UB2PA	2	2.4	3.3	1.2	2.5	1.5	⅜	⅜-16 UNC-2B	42
	50.8	60.2	84.3	31.5	63.5	36.8	9.5		19.1
UB2 1/2 PA	2½	2.9	3.9	1.2	3.0	1.7	½	½-13 UNC-2B	72
	63.5	72.9	98.6	31.5	76.2	42.9	12.7		32.7
UB3PA	3	3.5	4.5	1.2	3.3	2.0	½	½-13 UNC-2B	84
	76.2	88.9	114.3	31.5	83.8	50.8	12.7		38.1
UB3 1/2 PA	3½	4.0	5.0	1.2	3.7	2.3	½	½-13 UNC-2B	93
	88.9	101.6	127.0	31.5	94.0	57.2	12.7		42.2
UB4PA	4	4.5	5.5	1.2	3.9	2.5	½	½-13 UNC-2B	102
	101.6	114.3	139.7	31.5	99.1	63.5	12.7		46.3
UB5PA	5	5.6	6.6	1.2	4.5	3.0	½	½-13 UNC-2B	123
	127.0	141.2	167.4	31.5	114.3	77.0	12.7		55.8
UB6PA	6	6.6	7.8	1.4	5.4	3.6	⅝	⅝-11 UNC-2B	123
	152.4	168.1	198.4	36.6	137.2	90.4	15.9		55.8
UB8PA	8	8.6	9.8	1.4	6.4	4.6	⅝	⅝-11 UNC-2B	243
	203.2	218.9	249.9	36.6	162.6	115.8	15.9		110.2
UB10PA	10	10.8	12.3	1.7	7.7	5.7	¾	¾-10 UNC-2B	492
	254.0	273.1	311.2	41.9	195.6	144.3	19.1		223.2
UB12PA	12	12.8	14.3	1.7	8.7	6.7	¾	¾-10 UNC-2B	563
	304.8	323.9	362.0	41.9	221.0	169.7	19.1		255.4

CUSH-A-NATOR®

**STEEL**

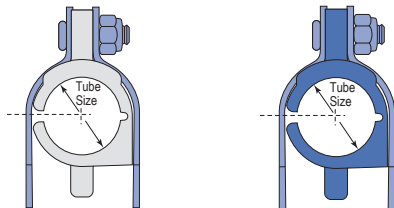

The Cush-A-Nator cushion is made from a new extremely durable thermoplastic rubber that resists high heat and provides longer life against vibration fatigue.

Part Number	Clamp Material	Size
CN04	Steel	1/4"
CN26	Steel	1-5/8"
CN24	Steel	1-1/2"
CN22	Steel	1-3/8"
CN18	Steel	1-1/8"
CN16	Steel	1"
CN14	Steel	7/8"
CN12	Steel	3/4"
CN10	Steel	5/8"
CN08	Steel	1/2"
CN06	Steel	3/8"
CN34	Steel	1-1/8"

Part Number	Clamp Material	Size
HT04	Steel	1/4"
HT26	Steel	1-5/8"
HT24	Steel	1-1/2"
HT22	Steel	1-3/8"
HT18	Steel	1-1/8"
HT16	Steel	1"
HT14	Steel	7/8"
HT10	Steel	5/8"
HT08	Steel	1/2"
HT06	Steel	3/8"
HT34	Steel	2-1/8"



**CG-10 THRU CG-40**

**CUSH-A-GRIP®**

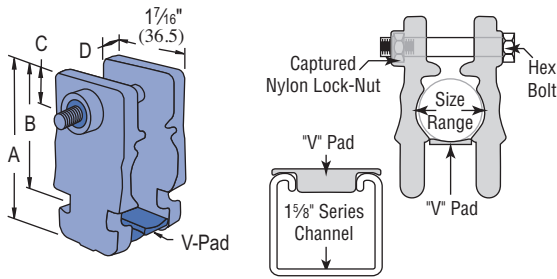

Part Number	O.D. Tube Sizes In(mm)			Nominal Pipe Sizes In(mm)		Diameters In(mm)	PullOut Load Lbs(kN)	Slip Load Lbs(kN)
CG-10	1/4	3/8	1/2	1/4		0.25 - 0.54	500	40
	6.4	9.5	12.7	6.4		6.4 - 13.7	2.22	0.18
CG-20	5/8	3/4	7/8	3/8	1/2	0.62 - 0.87	500	40
	15.9	19.1	22.2	9.5	12.7	15.7 - 22.1	2.22	0.18
CG-30	7/8	1	1 1/8	3/4		0.87 - 1.12	500	40
	22.2	25.4	28.6	19.1		22.1 - 28.4	2.22	0.18
CG-40	1	1 1/8	1 1/4	3/4	1	1.00 - 1.31	500	40
	25.4	28.6	31.8	19.1	25.4	25.4 - 33.3	2.22	0.18

Includes: Cushion, V-pad, and Hardware.

Materials: Cushion: Thermoplastic elastomer.

Hardware: Stainless Steel with Captured Nylon Locknut

Temperature Rating: -40° F to +275° F (-40° C to 135° C)

Part Number	Nominal Pipe Size	"A" In(mm)	"B" In(mm)	"C" In(mm)	"D" In(mm)	Hex Head Cap Screw & Lock Nut	Wt/100 Lbs(kg)
CG-10	1/4	1 5/16	1 3/8	3/8	3/16	1/4-20 x 1 1/2"	4
		49.2	34.9	9.5	4.8		1.8
CG-20	3/8	2 3/8	1 5/8	7/16	1/4	1/4-20 x 2"	6
		60.3	41.3	11	6.4		2.7
CG-30	1/2	2 9/16	1 3/16	7/16	5/16	1/4-20 x 2"	8
		65.1	46.0	11	7.9		3.6
CG-40	3/4	2 1/16	1 5/16	7/16	5/16	1/4-20 x 2"	8
		68.3	49.2	11	7.9		3.6

**PUX1234 THRU PUX41810**

**CUSH-A-THERM™**

The only airtight, crush-resistant insulation clamp on the market.

- Maintains thermal barrier protection
- Prevents condensation
- Properly supports pipe and tube
- Absorbs vibration

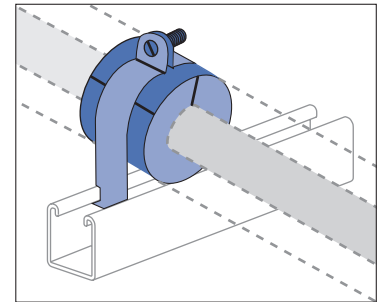
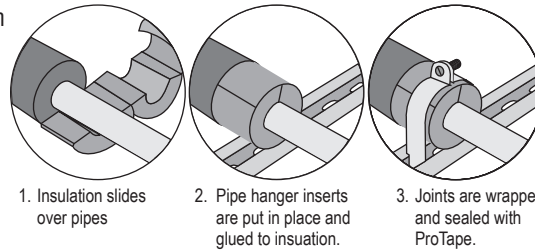

Nominal 3/4" Wall

Part Number	Hole Size In(mm)	Copper Nom. I.D. In(mm)	O.D. In(mm)	IPS In(mm)	O.D. In(mm)	Length In(mm)
PUX3834	5/8 ID	1/4	3/8	-	1.81	2.17
	9.5	6.4	9.5	-	46.0	55.1
PUX1234	1/2 ID	3/8	1/2	1/4	1.89	2.17
	12.7	9.5	12.7	6.4	48.0	55.1
PUX5834	5/8 ID	1/2	5/8	3/8	2.05	2.17
	15.9	12.7	15.9	9.5	52.1	55.1
PUX3434	3/4 ID	5/8	3/4	-	2.22	2.17
	19.1	15.9	19.1	-	56.4	55.1
PUX7834	7/8 ID	3/4	7/8	1/2	2.44	2.17
	22.2	19.1	22.2	12.7	62.0	55.1
PUX11834	1 1/8 ID	1	1 1/8	3/4	2.76	2.17
	28.6	25.4	28.6	19.1	70.1	55.1
PUX13834	1 1/8 ID	1 1/4	1 1/8	1	3.19	2.56
	34.9	31.8	34.9	25.4	81.0	65.0
PUX15834	1 1/8 ID	1 1/2	1 1/8	1 1/4	3.35	2.58
	41.3	38.1	41.3	31.8	85.1	65.5
PUX21834	2 1/8 ID	2	2 1/8	-	3.86	2.56
	54.0	50.8	54.0	-	98.0	65.0
PUX23834	2 3/8 ID	2 1/4	2 3/8	2	4.29	2.96
	60.3	57.2	60.3	50.8	109.0	75.2
PUX25834	2 3/8 ID	2 1/2	2 3/8	-	4.87	2.96
	66.7	63.5	66.7	-	123.7	75.2
PUX31834	3 1/8 ID	3	3 1/8	-	5	3.35
	79.4	76.2	79.4	-	127.0	85.1
PUX35834	3 3/8 ID	3 1/2	3 3/8	-	5.94	3.94
	92.1	88.9	92.1	-	150.9	100.1
PUX41834	4 1/8 ID	4	4 1/8	3 1/2	6.14	3.94
	104.8	101.6	104.8	88.9	156.0	100.1

Nominal 1" Wall

Part Number	Hole Size In(mm)	Copper Nom. I.D. In(mm)	O.D. In(mm)	IPS In(mm)	O.D. In(mm)	Length In(mm)
PUX5810	5/8 ID	1/2	5/8	3/8	2.54	2.2
	15.9	12.7	15.9	9.5	64.5	55.1
PUX3410	3/4 ID	5/8	3/4	-	2.82	2.2
	19.1	15.9	19.1	-	71.6	55.1
PUX7810	7/8 ID	3/4	7/8	1/2	2.82	2.2
	22.2	19.1	22.2	12.7	71.6	55.1
PUX11810	1 1/8 ID	1	1 1/8	3/4	3.06	2.2
	28.6	25.4	28.6	19.1	77.7	55.1
PUX13810	1 1/8 ID	1 1/4	1 1/8	1	3.33	2.6
	34.9	31.8	34.9	25.4	84.6	65.0
PUX15810	1 1/8 ID	1 1/2	1 1/8	1 1/4	3.65	2.6
	41.3	38.1	41.3	31.8	92.7	65.0
PUX21810	2 1/8 ID	2	2 1/8	-	4.16	2.6
	54.0	50.8	54.0	-	105.7	65.0
PUX23810	2 3/8 ID	2 1/4	2 3/8	2	3.92	2.6
	60.3	57.2	60.3	50.8	99.6	65.0
PUX25810	2 3/8 ID	2 1/2	2 3/8	-	4.87	3.0
	66.7	63.5	66.7	-	123.7	75.2
PUX31810	3 1/8 ID	3	3 1/8	-	5.14	3.4
	79.4	76.2	79.4	-	130.6	85.1
PUX35810	3 3/8 ID	3 1/2	3 3/8	-	6.48	3.9
	92.1	88.9	92.1	-	164.6	100.1
PUX41810	4 1/8 ID	4	4 1/8	3 1/2	6.48	3.9
	104.8	101.6	104.8	88.9	164.6	100.1

**Pipe Hangers**

**J1205 THRU J1280, J1205 N THRU J1280 N (PLASTIC COATED)**

**"J" CONDUIT & PIPE HANGER** **EG**

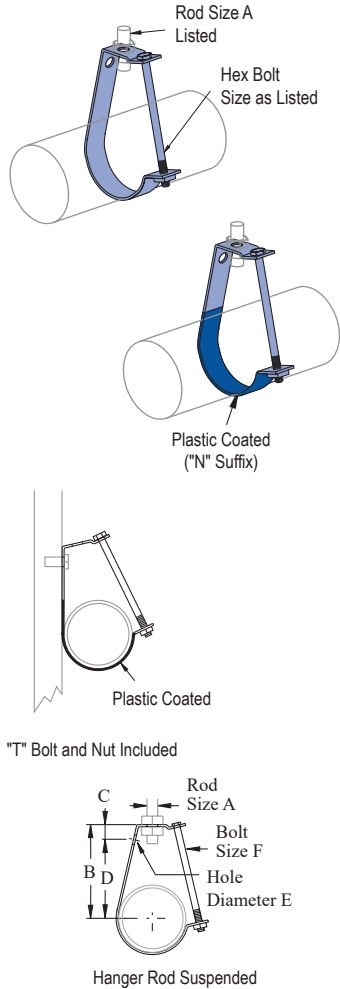

Part No.	Wt/100 pcs Lbs (kg)	Part No.	Wt/100 pcs Lbs (kg)	Pipe Size In	"A" In (mm)	"B" In (mm)	"C" In (mm)	"D" In (mm)	"E" In (mm)	"F" In (mm)	Load Lbs (kN)
J1205	20 9.1	J1205N	21 9.5	1/2	3/8 9.5	2 5/8 66.7	1 25.4	2 50.8	1 3/32 10.3	1/4 x 2 1/4 6.4 x 57.2	400 1.78
J1207	21 9.5	J1207N	22 10.0	3/4	3/8 9.5	2 7/8 73.0	1 25.4	2 1/4 57.2	1 3/32 10.3	1/4 x 2 1/4 6.4 x 57.2	400 1.78
J1210	24 10.9	J1210N*	25 11.3	1	3/8 9.5	3 76.2	1 25.4	2 3/8 60.3	1 3/32 10.3	1/4 x 2 1/2 6.4 x 63.5	400 1.78
J1212	27 12.2	J1212N	29 13.2	1 1/4	3/8 9.5	3 1/4 82.6	1 25.4	2 1/2 63.5	1 3/32 10.3	1/4 x 2 3/4 6.4 x 69.9	400 1.78
J1215	29 13.2	J1215N*	31 14.1	1 1/2	3/8 9.5	3 1/2 88.9	1 25.4	2 5/8 66.7	1 3/32 10.3	1/4 x 3 6.4 x 76.2	400 1.78
J1220	33 15.0	J1220N*	35 15.9	2	3/8 9.5	3 3/4 95.3	1 1/8 28.6	2 5/8 66.7	1 3/32 10.3	1/4 x 3 1/2 6.4 x 88.9	400 1.78
J1225	71 32.2	J1225N	74 33.6	2 1/2	1/2 12.7	4 3/8 111.1	1 1/8 28.6	3 3/8 92.1	3/16 14.3	3/8 x 4 1/2 9.5 x 114.3	800 3.56
J1230	78 35.4	J1230N*	81 36.7	3	1/2 12.7	4 7/8 123.8	1 1/8 28.6	4 101.6	3/16 14.3	3/8 x 5 9.5 x 127.0	800 3.56
J1235	85 38.6	J1235N	88 39.9	3 1/2	1/2 12.7	5 1/8 130.2	1 1/8 28.6	4 1/4 108.0	3/16 14.3	3/8 x 6 9.5 x 152.4	800 3.56
J1240	178 80.7	J1240N*	182 82.6	4	3/8 15.9	6 1/8 155.6	1 1/8 28.6	5 1/8 130.2	3/16 14.3	3/8 x 6 9.5 x 152.4	800 3.56
J1250	199 90.3	J1250N	203 92.1	5	3/8 15.9	6 3/4 171.5	1 1/8 28.6	5 3/4 146.1	3/16 14.3	3/8 x 7 1/2 9.5 x 190.5	800 3.56
J1260	231 104.8	J1260N*	236 107.0	6	3/4 19.1	7 3/4 196.9	1 1/4 31.8	6 1/2 165.1	3/16 14.3	3/8 x 8 1/2 9.5 x 215.9	1,000 4.45
J1280	449 203.7	J1280N	458 207.7	8	7/8 22.2	9 1/4 235.0	1 1/4 31.8	8 203.2	3/16 14.3	3/8 x 10 9.5 x 254.0	1,200 5.34

\*Standard glass drainline and glass process pipe sizes. Minimum safety factor of five (5) on ultimate load.

**P2474**

**PIPE ROLLER FOR 1/2" - 4" PIPE** **EG GR**

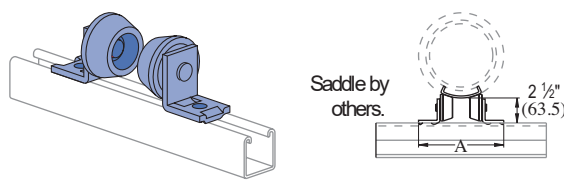

Sold in pairs.

Requires 2 each 1/2" x 1 5/16" bolts and 1/2" channel nuts per assembly. Sold separately.

**Design Load**  
500 Lbs (2.22kN)

Wt/100 pcs: 268 Lbs (121.6 kg)

Chart for Dimension A

Pipe Size In	No Insulation In (mm)	Insulation Thickness					
		1" In (mm)	1 1/2" In (mm)	2" In (mm)	2 1/2" In (mm)	3" In (mm)	4" In (mm)
1/2	6 1/2	6 1/2	-	-	-	-	-
	165.1	165.1	-	-	-	-	-
3/4	6 1/2	6 1/2	6 3/8	6 3/8	-	-	-
	165.1	165.1	168.3	174.6	-	-	-
1	6 1/2	6 1/2	6 3/8	6 3/8	-	-	-
	165.1	165.1	168.3	174.6	-	-	-
1 1/4	6 1/2	6 1/2	6 3/8	7 3/8	7 3/8	-	-
	165.1	165.1	174.6	181.0	187.3	-	-
1 1/2	6 1/2	6 1/2	6 3/8	7 3/8	7 3/8	-	-
	165.1	165.1	174.6	181.0	187.3	-	-
2	6 1/2	6 3/8	7 3/8	7 3/8	7 1/2	8	-
	165.1	168.3	181.0	187.3	190.5	203.2	-
2 1/2	6 1/2	6 3/8	7 3/8	7 3/8	7 1/2	8	-
	165.1	168.3	181.0	187.3	190.5	203.2	-
3	6 1/2	7	7 1/2	7 3/4	7 3/8	8 1/8	-
	165.1	177.8	190.5	196.9	200.0	206.4	-
3 1/2	6 1/2	7	7 1/2	7 3/4	7 3/8	8 3/8	-
	165.1	177.8	190.5	196.9	200.0	206.4	-
4	6 3/8	7 1/4	7 3/8	7 3/8	8	8 3/8	9
	168.3	184.2	193.7	200.0	203.2	212.7	228.6

1 1/2" Channel  
Telestrut  
Nuts & Hardware  
General Fittings  
Pipe/Conduit Supports  
Electrical Fittings  
Concrete Inserts  
Solar  
Unipier®



**P2474-1 THRU P2474-4**

**PIPE ROLLER FOR 1" - 8" PIPE** EG GR

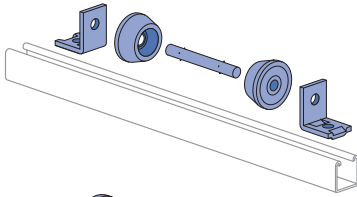

Parts are shipped loose and are easily assembled during installation.

Design Load  
750 Lbs (3.34 kN)

Part Number	A In (mm)	W/100 pcs Lbs (kg)
P2474-1	6 3/4 171.5	299 135.6
P2474-2	7 1/2 190.5	304 137.9
P2474-3	8 1/2 215.9	311 141.1
P2474-4	9 9/16 242.9	319 144.7

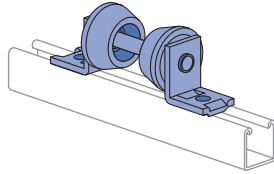
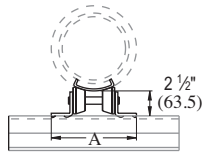

Chart for Roller Part Number Selection

Pipe Size In	No Insulation	Insulation Thickness					
		1" (25.4)	1 1/2" (38.1)	2" (50.8)	2 1/2" (63.5)	3" (76.2)	4" (101.6)
1/2	P2474-1	P2474-1	P2474-1	P2474-2	-	-	-
3/4	P2474-1	P2474-1	P2474-1	P2474-2	-	-	-
1	P2474-1	P2474-1	P2474-1	P2474-2	-	-	-
1 1/4	P2474-1	P2474-1	P2474-1	P2474-2	-	-	-
1 1/2	P2474-1	P2474-1	P2474-2	P2474-2	P2474-2	-	-
2	P2474-1	P2474-1	P2474-2	P2474-2	P2474-2	-	-
2 1/2	P2474-1	P2474-1	P2474-2	P2474-2	P2474-2	-	-
3	P2474-1	P2474-2	P2474-2	P2474-3	P2474-3	P2474-3	-
3 1/2	P2474-1	P2474-2	P2474-2	P2474-3	P2474-3	P2474-3	-
4	P2474-1	P2474-2	P2474-2	P2474-3	P2474-3	P2474-3	-
5	P2474-2	P2474-3	P2474-3	P2474-3	P2474-3	P2474-4	P2474-4
6	P2474-2	P2474-3	P2474-3	P2474-3	P2474-3	P2474-4	P2474-4
8	P2474-2	P2474-3	P2474-4	P2474-4	P2474-4	P2474-4	P2474-4



Saddle by others.

- Pipe roller will fit standard saddles.
- Select proper roller from chart.
- Requires 2 each 1/2" x 1 5/16" bolts and 1/2" channel nuts per assembly. Sold separately.

**P2475**

**PIPE ROLLER FOR 6" - 16" PIPE** EG GR

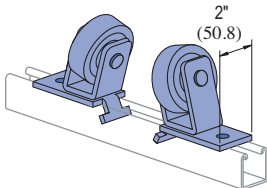

Material: Cast iron rollers.  
• Requires 2 each 1/2" x 1 5/16" bolts and 1/2" channel nuts per assembly. Sold separately.

Chart for Dimension A

Pipe Size In	No Insulation In (mm)	Insulation Thickness					
		1" In (mm)	1 1/2" In (mm)	2" In (mm)	2 1/2" In (mm)	3" In (mm)	4" In (mm)
6	9 1/2	10 1/4	10 1/2	10 3/4	11	11 3/8	11 7/8
	241.3	260.4	266.7	273	279.4	288.9	301.6
8	10 3/8	*	11	11 3/8	11 3/4	12	12 1/2
	257.2		279.4	288.9	298.5	304.8	317.5
10	10 3/4	*	11 3/8	12	12 1/4	12 1/2	13
	273.1		295.3	304.8	311.2	317.5	330.2
12	11 1/4	*	12 3/8	12 1/2	12 3/4	13	13 1/2
	285.8		308.0	317.5	323.9	330.2	342.9
14	11 3/8	*	12 1/2	12 3/8	13	13 3/8	14
	295.3		317.5	327.0	330.2	339.7	355.6
16	12 3/8	*	13	13 3/8	13 3/8	14	14 1/2
	308.0		330.2	339.7	352.4	355.6	368.3

(\*Not used for this size)

Sold in pairs.

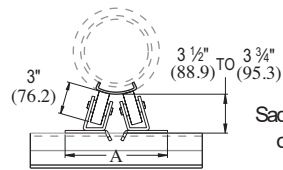

Saddle by others.

Design Load  
1500 Lbs (6.67 kN)

W/100 pcs: 680 Lbs (308.4 kg)

Standard Dimensions for 1 1/2" (41.3mm) width series channel fittings (Unless Otherwise Shown on Drawing)

Hole Diameter: 9/16" (14.3mm); Hole Spacing - From End: 1 3/8" (20.6mm); Hole Spacing - On Center: 1 7/8" (47.6mm); Width: 1 1/2" (41.3mm); Thickness: 1/4" (6.4mm)

**Pipe Brackets**

**P2476**

**PIPE ROLLER FOR 16" - 24" PIPE** EG GR

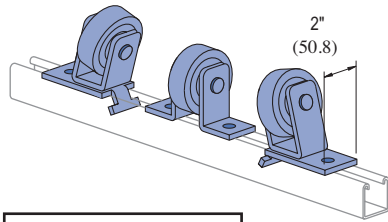

- Requires 4 each 1/2" x 1/16" bolts and 1/2" channel nuts per assembly. Sold separately.

**Design Load**  
2000 Lbs (8.90 kN)

Material: Cast iron rollers.

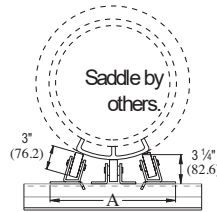
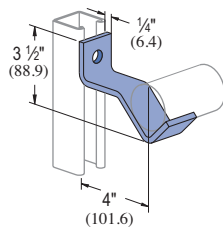

Chart for Dimension A

Pipe Size In	Insulation Thickness				
	1 1/2" In (mm)	2" In (mm)	2 1/2" In (mm)	3" In (mm)	4" In (mm)
16	-	-	13 3/8	14	14 1/2
	-	-	352.4	355.6	368.3
18	13 3/8	14	14 1/8	14 1/2	15
	346.1	355.6	358.8	368.3	381.0
20	14 1/8	14 1/2	14 3/4	15	15 1/2
	358.8	368.3	374.7	381.0	393.7
24	15 1/4	15 1/2	15 3/8	16 1/8	16 3/8
	387.4	393.7	403.2	409.6	422.3

Wt/100 pcs: 1046 Lbs (474.5 kg)

**P2481** **PIPE SUPPORT BRACKET**



For 1/2" pipe to 1 1/2" pipe.

Wt/100 pcs	Design Load (Upright Channel)			
	P1000	P1100	P2000	
	Lbs (kg)	Lbs (kN)	Lbs (kN)	Lbs (kN)
90	85	85	85	
40.8	0.38	0.38	0.38	

**P2482** **PIPE SUPPORT BRACKET**

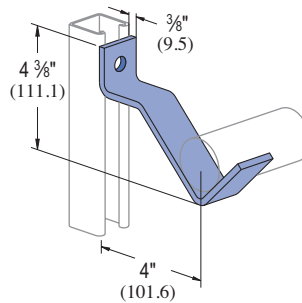

For 2" pipe to 3" pipe.

Wt/100 pcs	Design Load (Upright Channel)			
	P1000	P1100	P2000	
	Lbs (kg)	Lbs (kN)	Lbs (kN)	Lbs (kN)
139	185	120	95	
63.0	0.82	0.53	0.42	

**P2243** **PIPE BLOCK**

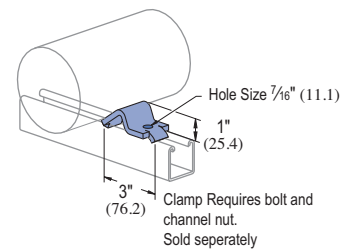

For 2" (50.8) to 8" (203.2) Pipes

Wt/100 pcs: 40 Lbs (18.1 kg)

Standard Dimensions for 1 1/8" (41.3mm) width series channel fittings (Unless Otherwise Shown on Drawing)  
Hole Diameter: 3/16" (14.3mm); Hole Spacing - From End: 1 3/16" (20.6mm); Hole Spacing - On Center: 1 7/8" (47.6mm); Width: 1 1/8" (41.3mm); Thickness: 1/4" (6.4mm)



Nominal Pipe Dia.	Centerline to Centerline (In/mm)																	
	¾" (19.1mm)			1" (25.4mm)			1¼" (31.8mm)			1½" (38.1mm)			2" (50.8mm)			2½" (63.5mm)		
	T	S		T	F	S	T	F	S	T	F	S	T	F	S	T	F	S
¾" 19.1mm	T	4¾	—	—	—	—	—	—	—	—	—	—	—	—	—	—	—	—
	S	4½	4¾	—	—	—	—	—	—	—	—	—	—	—	—	—	—	—
1" 25.4mm	T	5	4¾	5¼	—	—	—	—	—	—	—	—	—	—	—	—	—	—
	F	6	5¼	6¼	7¼	—	—	—	—	—	—	—	—	—	—	—	—	—
	S	4¾	4½	5	6	4½	—	—	—	—	—	—	—	—	—	—	—	—
1¼" 31.8mm	T	5¼	5	5½	6½	5	5½	—	—	—	—	—	—	—	—	—	—	—
	F	6¼	6	6½	7½	6¼	6¼	7¼	—	—	—	—	—	—	—	—	—	—
	S	4¾	4½	5	6	4½	5¼	6¼	4¾	—	—	—	—	—	—	—	—	—
1½" 38.1mm	T	5¼	5	5½	6½	5¼	5¼	6¼	5¼	5¼	—	—	—	—	—	—	—	—
	F	6½	6¼	6¼	7¼	6¼	6¼	8	6½	7	8	—	—	—	—	—	—	—
	S	5	4¾	5¼	6¼	4¾	5¼	6	5	5½	6½	5	—	—	—	—	—	—
2" 50.8mm	T	5¾	5½	6	7	5½	6	7¼	5¼	6¼	7¼	5¼	6½	—	—	—	—	—
	F	7	6¼	7¼	8¼	6¼	7¼	8½	7	7½	8½	7	7¼	9	—	—	—	—
	S	5¼	5	5½	6½	5	5½	6¼	5¼	5¼	6¼	5¼	6	7¼	5½	—	—	—
2½" 63.5mm	T	6	5¼	6¼	7¼	6	6½	7½	6	6½	7¼	6¼	7	8¼	6½	7¼	—	—
	F	7½	7¼	7¼	8¼	7¼	7¼	9	7½	8	9	7½	8¼	9½	7¼	8¼	10	—
	S	5½	5¼	5¼	6¼	5¼	5¼	7	5½	6	7	5½	6¼	7½	5¼	6¼	8	6
3" 76.2mm	T	6¼	6	6½	7½	6¼	6¼	7¼	6¼	6¼	8	6½	7¼	8½	6¼	7½	9	7
	F	7¼	7½	8	9	7½	8	9¼	7¼	8¼	9¼	7¼	8½	9¼	8	9	10¼	8¼
	S	5¼	5½	6	7	5½	6	7¼	5¼	6¼	7¼	5¼	6½	7¼	6	7	8¼	6¼
4" 101.6mm	T	7½	7¼	7¼	8¼	7¼	7¼	9	7½	8	9	7½	8¼	9½	7¼	8¼	10	8
	F	9	8¼	9¼	10¼	8¼	9¼	10½	9	9½	10½	9	9¼	11	9¼	10¼	11½	9½
	S	6¼	6½	7	8	6½	7	8¼	6¼	7¼	8¼	6¼	7½	8¼	7	8	9¼	7¼
5" 127.0mm	T	8	7¼	8¼	9¼	7¼	8¼	9½	8	8½	9½	8	8¼	10	8¼	9¼	10½	8½
	F	9½	9¼	9¼	10¼	9¼	9¼	11	9½	10	11	9½	10¼	11½	9¼	10¼	12	10
	S	7¼	7	7½	8¼	7	7½	8¼	7¼	7¼	8¼	7¼	8	9¼	7½	8½	9¼	7¼
6" 152.4mm	T	8¼	8½	9	10	8½	9	10¼	8¼	9¼	10¼	8¼	9½	10¼	9	10	11¼	9¼
	F	10	9¼	10¼	11¼	9¼	10¼	11½	10	10½	11½	10	10¼	12	10¼	11¼	12½	10½
	S	7¼	7½	8	9	7½	8	9¼	7¼	8¼	9¼	7¼	8½	9¼	8	9	10¼	8¼
8" 203.2mm	T	8¼	9½	10	11	9¼	10½	11¼	9¼	10¼	11½	10	10¼	12	10½	11	12½	10½
	F	11¼	11	11½	12½	11	11½	12¾	11¼	11¼	12¾	11¼	12	13¼	11½	12½	13¾	11¾
10" 254.0mm	T	11¼	11	11½	12½	11	11½	12¾	11¼	11¼	12¾	11¼	12	13¼	11½	12½	13¾	11¾
	F	12½	12¼	12¾	13¾	12¼	12¾	14	12½	13	14	12½	13¼	14½	12¾	13¾	15	13
12" 304.8mm	T	12¼	12	12½	13½	12	12½	13¾	12¼	12¾	13¾	12¼	13	14¼	12½	13½	14¾	12¾
	F	14	13¾	14¼	15¼	13¾	14¼	15½	14	14½	15½	14	14¾	16	14¾	15¼	16½	14½



**Pipe & Conduit Reference Data**

**PIPE SPACING TABLE**

This chart, developed by Julius Getlan of Seelye Stevenson Value & Knecht, consulting engineers, New York City, enables one to quickly determine the centerline-to-centerline dimension between any two size pipes on a rack.

Select the smaller pipe size at top and select the other at the side of the table. Where the appropriate columns intersect, the dimension is given.

These factors are included in the dimensions given:

- O.D. of flanges and fittings.
- 1" insulation over flanges and fittings.
- All fractional dimensions less than 1/4" were increased to the next larger 1/4".
- Clear space between fittings as follows:
  1. 1" between piping 3" and smaller.
  2. 1 1/2" between a pipe 3" and smaller and a pipe 4" or larger.
  3. 2" between piping 4" and larger.

T – denotes threaded IPS pipe. F – denotes flanged fittings on pipe. S – denotes soldered or brazed tubing.

Centerline to Centerline (In/mm)																				Nominal Pipe Dia.
3" (76.2mm)			4" (101.6mm)			5" (127.0mm)			6" (152.4mm)			8" (203.2mm)		10" (254.0mm)		12" (304.8mm)				
T	F	S	T	F	S	T	F	S	T	F	S	T	F	T	F	T	F			
7/4	-	-	-	-	-	-	-	-	-	-	-	-	-	-	-	-	-		-	T
196.9	-	-	-	-	-	-	-	-	-	-	-	-	-	-	-	-	-	-		
9/4	10 1/2	-	-	-	-	-	-	-	-	-	-	-	-	-	-	-	-	-	F	
235.0	266.7	-	-	-	-	-	-	-	-	-	-	-	-	-	-	-	-	-		
7/4	8 1/2	6 1/2	-	-	-	-	-	-	-	-	-	-	-	-	-	-	-	-	S	
184.2	215.9	165.1	-	-	-	-	-	-	-	-	-	-	-	-	-	-	-	-		
9	10 1/4	8 1/4	10	-	-	-	-	-	-	-	-	-	-	-	-	-	-	-	T	
228.6	260.4	209.6	254.0	-	-	-	-	-	-	-	-	-	-	-	-	-	-	-		
10 1/2	11 3/4	9 3/4	11 1/2	13	-	-	-	-	-	-	-	-	-	-	-	-	-	-	F	
266.7	298.5	247.7	292.1	330.2	-	-	-	-	-	-	-	-	-	-	-	-	-	-		
8 1/4	9 1/2	7 1/2	9 1/4	10 3/4	8 1/2	-	-	-	-	-	-	-	-	-	-	-	-	-	S	
209.6	241.3	190.5	235.0	273.1	215.9	-	-	-	-	-	-	-	-	-	-	-	-	-		
9 1/2	10 3/4	8 3/4	10 1/4	12	9 3/4	11	-	-	-	-	-	-	-	-	-	-	-	-	T	
241.3	273.1	222.3	260.4	304.8	247.7	279.4	-	-	-	-	-	-	-	-	-	-	-	-		
11	12 1/4	10 1/4	12	13 1/2	11 1/4	12 1/2	14	-	-	-	-	-	-	-	-	-	-	-	F	
279.4	311.2	260.4	304.8	342.9	285.8	317.5	355.6	-	-	-	-	-	-	-	-	-	-	-		
8 3/4	10	8	9 3/4	11 1/4	9	10 1/4	11 3/4	9 1/2	-	-	-	-	-	-	-	-	-	-	S	
222.3	254.0	203.2	247.7	285.8	228.6	260.4	298.5	241.3	-	-	-	-	-	-	-	-	-	-		
10 1/4	11 1/2	9 1/2	11 1/4	12 3/4	10 1/2	11 3/4	13 3/4	11	12 1/2	-	-	-	-	-	-	-	-	-	T	
260.4	292.1	241.3	285.8	323.9	266.7	298.5	336.6	279.4	317.5	-	-	-	-	-	-	-	-	-		
11 1/2	12 1/4	10 3/4	12 1/2	14	11 3/4	13	14 1/2	12 1/4	13 3/4	15	-	-	-	-	-	-	-	-	F	
292.1	311.2	273.1	317.5	355.6	298.5	330.2	368.3	311.2	336.6	381.0	-	-	-	-	-	-	-	-		
9 1/4	10 1/2	8 1/2	10 1/4	11 3/4	9 1/2	10 3/4	12 1/4	10	11 1/2	12 3/4	10 1/2	-	-	-	-	-	-	-	S	
235.0	266.7	215.9	260.4	298.5	241.3	273.1	311.2	254.0	292.1	323.9	266.7	-	-	-	-	-	-	-		
11 1/4	12 3/4	10 3/4	12 1/2	14	11 3/4	13	14 1/2	12 1/4	13 3/4	15	12 3/4	14 3/4	-	-	-	-	-	-	T	
285.8	323.9	273.1	317.5	355.6	298.5	330.2	368.3	311.2	349.3	381.0	323.9	374.7	-	-	-	-	-	-		
12 3/4	14	12	13 3/4	15 1/4	13	14 1/4	15 3/4	13 1/2	15	16 1/4	14	16 1/4	17.5	-	-	-	-	-	F	
323.9	355.6	304.8	349.3	387.4	330.2	362.0	400.1	342.9	381.0	412.8	355.6	412.8	17.5	-	-	-	-	-		
12 3/4	14	12	13 3/4	15 1/4	13	14 1/4	15 3/4	13 1/2	15	16 1/4	14	16 1/4	17 1/2	17 1/2	-	-	-	-	T	
323.9	355.6	304.8	349.3	387.4	330.2	362.0	400.1	342.9	381.0	412.8	355.6	412.8	444.5	444.5	-	-	-	-		
14	15 1/4	13 1/4	15	16 1/2	14 1/4	15 1/2	17	14 3/4	16 1/4	17 1/2	15 1/4	17 1/2	18 3/4	18 3/4	20	-	-	-	F	
355.6	387.4	336.6	381.0	419.1	362.0	393.7	431.8	374.7	412.8	444.5	387.4	444.5	476.3	476.3	508.0	-	-	-		
13 3/4	15	13	14 3/4	16 1/4	14	15 1/4	16 3/4	14 1/2	16	17 1/4	15	17 1/4	18 1/2	18 1/2	19 3/4	19 1/2	-	-	T	
349.3	381.0	330.2	374.7	412.8	355.6	387.4	425.5	368.3	406.4	438.2	381.0	438.2	469.9	469.9	501.7	495.3	-	-		
15 1/2	16 3/4	14 3/4	16 1/2	18	15 3/4	17	18 1/4	16 1/4	17 3/4	19	16 3/4	14	20 1/4	20 1/4	21 1/2	21 1/4	29	-	F	
393.7	425.5	374.7	419.1	457.2	400.1	431.8	463.6	412.8	450.9	482.6	425.5	355.6	514.4	514.4	546.1	539.8	736.6	-		



**CHANNEL SELECTION FOR SCHEDULE 10 SPRINKLER PIPE TRAPEZE HANGERS**

Note: Based on NFPA-13-2013-Table 9.1.1.7.1(a). Each of the following tables indicate the allowable span of the trapeze and the nominal pipe size for the specified channel. An entry of "N/A" indicates that the channel cannot be used for this span/pipe size combination. The table is based on a maximum allowable bending stress of 15 KSI and a midspan concentrated load from 15 ft of water-filled pipe, plus 250 lb.

Unistrut Channel	Section Modulus in <sup>3</sup> (cm <sup>3</sup> )
P3000	0.154 2.52
P1000	0.202 3.31
P5500	0.391 6.41
P5000	0.628 10.29

Unistrut Channel	Section Modulus in <sup>3</sup> (cm <sup>3</sup> )
P3001	0.431 7.06
P1001	0.572 9.37
P5501	1.153 18.89
P5001	1.916 31.40

Nominal Pipe Dia. (in)	O.D. (in)	Schedule 10 Pipe		Pipe Weight (p/f)	Water Weight (p/f)	Total Weight (p/f)
		Wall Thickness (in)	I. D. (in)			
1	1.315	0.109	1.097	1.41	0.42	1.83
1¼	1.660	0.109	1.442	1.81	0.73	2.54
1½	1.900	0.109	1.682	2.09	0.99	3.08
2	2.375	0.109	2.157	2.64	1.63	4.28
2½	2.875	0.120	2.635	3.53	2.44	5.97
3	3.500	0.120	3.260	4.34	3.73	8.07
3½	4.000	0.120	3.760	4.98	4.97	9.95
4	4.500	0.120	4.260	5.62	6.38	12.00
5	5.563	0.134	5.295	7.78	9.85	17.63
6	6.625	0.134	6.357	9.30	14.20	23.50
8	8.625	0.188	8.249	16.96	23.91	40.87
10	10.750	0.188	10.374	21.23	37.82	59.04

Trapeze Span	NFPA 13 Required Trapeze Section Modulus for Sch 10 Pipe											
	Pipe Diameter											
	1"	1¼"	1½"	2"	2½"	3"	3½"	4"	5"	6"	8"	10"
1' - 6"	0.08	0.08	0.09	0.09	0.10	0.11	0.12	0.13	0.15	0.18	0.26	0.34
2' - 0"	0.11	0.11	0.12	0.13	0.14	0.15	0.16	0.17	0.2	0.24	0.34	0.45
2' - 6"	0.14	0.14	0.15	0.16	0.18	0.21	0.23	0.25	0.3	0.36	0.5	0.69
3' - 0"	0.16	0.17	0.18	0.19	0.2	0.22	0.24	0.26	0.31	0.36	0.51	0.67
4' - 0"	0.22	0.22	0.24	0.25	0.27	0.30	0.32	0.34	0.41	0.48	0.68	0.89
5' - 0"	0.27	0.28	0.3	0.31	0.34	0.37	0.40	0.43	0.51	0.60	0.85	1.12
6' - 0"	0.33	0.34	0.35	0.38	0.41	0.44	0.48	0.51	0.61	0.71	1.02	1.34
7' - 0"	0.38	0.39	0.41	0.44	0.47	0.52	0.56	0.6	0.71	0.83	1.19	1.56
8' - 0"	0.43	0.45	0.47	0.5	0.54	0.59	0.63	0.68	0.82	0.95	1.36	1.79
9' - 0"	0.49	0.50	0.53	0.56	0.61	0.66	0.71	0.77	0.92	1.07	1.53	2.01
10' - 0"	0.54	0.56	0.59	0.63	0.68	0.74	0.79	0.85	1.02	1.19	1.7	2.23

Values taken from NFPA 13 (2013 Edition), Table 9.1.1.7.1(a)

Trapeze Span	Single Channel Trapeze for Sch 10 Pipe											
	Pipe Diameter											
	1"	1¼"	1½"	2"	2½"	3"	3½"	4"	5"	6"	8"	10"
1' - 6"	P3000	P3000	P3000	P3000	P3000	P3000	P3000	P3000	P3000	P1000	P5500	P5500
2' - 0"	P3000	P3000	P3000	P3000	P3000	P3000	P1000	P1000	P1000	P5500	P5500	P5000
2' - 6"	P3000	P3000	P3000	P1000	P1000	P5500	P5500	P5500	P5500	P5500	P5000	N/A
3' - 0"	P1000	P1000	P1000	P1000	P1000	P5500	P5500	P5500	P5500	P5500	P5000	N/A
4' - 0"	P5500	P5500	P5500	P5500	P5500	P5500	P5500	P5500	P5000	P5000	N/A	N/A
5' - 0"	P5500	P5500	P5500	P5500	P5500	P5500	P5000	P5000	P5000	P5000	N/A	N/A
6' - 0"	P5500	P5500	P5500	P5500	P5000	P5000	P5000	P5000	P5000	N/A	N/A	N/A
7' - 0"	P5500	P5500	P5000	P5000	P5000	P5000	P5000	P5000	N/A	N/A	N/A	N/A
8' - 0"	P5000	P5000	P5000	P5000	P5000	P5000	P5000	N/A	N/A	N/A	N/A	N/A
9' - 0"	P5000	P5000	P5000	P5000	P5000	N/A	N/A	N/A	N/A	N/A	N/A	N/A
10' - 0"	P5000	P5000	P5000	P5000	N/A	N/A	N/A	N/A	N/A	N/A	N/A	N/A

Trapeze Span	Double Channel Trapeze for Sch 10 Pipe											
	Pipe Diameter											
	1"	1¼"	1½"	2"	2½"	3"	3½"	4"	5"	6"	8"	10"
1' - 6"	P3001	P3001	P3001	P3001	P3001	P3001	P3001	P3001	P3001	P3001	P3001	P3001
2' - 0"	P3001	P3001	P3001	P3001	P3001	P3001	P3001	P3001	P3001	P3001	P3001	P3001
2' - 6"	P3001	P3001	P3001	P3001	P3001	P3001	P3001	P3001	P3001	P3001	P1001	P5501
3' - 0"	P3001	P3001	P3001	P3001	P3001	P3001	P3001	P3001	P3001	P3001	P1001	P5501
4' - 0"	P3001	P3001	P3001	P3001	P3001	P3001	P3001	P3001	P3001	P1001	P5501	P5501
5' - 0"	P3001	P3001	P3001	P3001	P3001	P3001	P3001	P3001	P1001	P5501	P5501	P5501
6' - 0"	P3001	P3001	P3001	P3001	P3001	P1001	P1001	P1001	P5501	P5501	P5501	P5001
7' - 0"	P3001	P3001	P3001	P1001	P1001	P1001	P1001	P5501	P5501	P5501	P5001	P5001
8' - 0"	P3001	P1001	P1001	P1001	P1001	P5501	P5501	P5501	P5501	P5501	P5001	P5001
9' - 0"	P1001	P1001	P1001	P1001	P5501	P5501	P5501	P5501	P5501	P5501	P5001	N/A
10' - 0"	P1001	P1001	P5501	P5501	P5501	P5501	P5501	P5501	P5501	P5501	P5001	N/A

# Pipe & Conduit Reference Data

## CHANNEL SELECTION FOR SCHEDULE 40 SPRINKLER PIPE TRAPEZE HANGERS

Note: Based on NFPA-13-2013-Table 9.1.1.7.1(a). Each of the following tables indicate the allowable span of the trapeze and the nominal pipe size for the specified channel. An entry of "N/A" indicates that the channel cannot be used for this span/pipe size combination. The table is based on a maximum allowable bending stress of 15 KSI and a midspan concentrated load from 15 ft of water-filled pipe, plus 250 lb.

Unistrut Channel	Section Modulus in <sup>3</sup> (cm <sup>3</sup> )
P3000	0.154 2.52
P1000	0.202 3.31
P5500	0.391 6.41
P5000	0.628 10.29

Unistrut Channel	Section Modulus in <sup>3</sup> (cm <sup>3</sup> )
P3001	0.431 7.06
P1001	0.572 9.37
P5501	1.153 18.89
P5001	1.916 31.40

Nominal Pipe Dia. (in)	Schedule 40 Pipe					
	O.D. (in)	Wall Thickness (in)	I. D. (in)	Pipe Weight (p/f)	Water Weight (p/f)	Total Weight (p/f)
1	1.315	0.133	1.049	1.68	0.39	2.07
1¼	1.660	0.140	1.380	2.27	0.67	2.94
1½	1.900	0.145	1.610	2.72	0.91	3.63
2	2.375	0.154	2.067	3.66	1.50	5.16
2½	2.875	0.203	2.469	5.80	2.14	7.94
3	3.500	0.216	3.068	7.58	3.31	10.89
3½	4.000	0.226	3.548	9.12	4.42	13.54
4	4.500	0.237	4.026	10.80	5.70	16.50
5	5.563	0.258	5.047	14.63	8.95	23.58
6	6.625	0.280	6.065	18.99	12.93	31.92
8	8.625	0.322	7.981	28.58	22.38	50.96
10	10.750	0.365	10.020	40.52	35.28	75.80

Trapeze Span	NFPA 13 Required Trapeze Section Modulus for Sch 40 Pipe											
	Pipe Diameter											
	1"	1¼"	1½"	2"	2½"	3"	3½"	4"	5"	6"	8"	10"
1' - 0"	0.08	0.09	0.09	0.1	0.11	0.12	0.14	0.15	0.18	0.22	0.3	0.41
2' - 0"	0.11	0.11	0.12	0.13	0.15	0.16	0.18	0.2	0.24	0.29	0.4	0.55
2' - 6"	0.14	0.14	0.15	0.16	0.17	0.18	0.2	0.21	0.25	0.3	0.43	0.56
3' - 0"	0.16	0.17	0.18	0.2	0.22	0.25	0.27	0.3	0.36	0.43	0.6	0.82
4' - 0"	0.22	0.23	0.24	0.26	0.29	0.33	0.36	0.4	0.48	0.58	0.8	1.1
5' - 0"	0.27	0.29	0.3	0.33	0.37	0.41	0.45	0.49	0.6	0.72	1	1.37
6' - 0"	0.33	0.34	0.36	0.39	0.44	0.49	0.54	0.59	0.72	0.87	1.2	1.64
7' - 0"	0.38	0.4	0.43	0.46	0.52	0.58	0.63	0.69	0.84	1.01	1.41	1.92
8' - 0"	0.44	0.46	0.49	0.52	0.59	0.66	0.72	0.79	0.96	1.16	1.61	2.19
9' - 0"	0.49	0.51	0.55	0.59	0.66	0.74	0.81	0.89	1.08	1.3	1.81	2.47
10' - 0"	0.55	0.57	0.61	0.65	0.74	0.82	0.9	0.99	1.2	1.45	2.01	2.74

Values taken from NFPA 13 (2013 Edition), Table 9.1.1.7.1(a)

Trapeze Span	Single Channel Trapeze for Sch 40 Pipe											
	Pipe Diameter											
	1"	1¼"	1½"	2"	2½"	3"	3½"	4"	5"	6"	8"	10"
1' - 0"	P3000	P3000	P3000	P3000	P3000	P3000	P3000	P3000	P1000	P5500	P5500	P5000
2' - 0"	P3000	P3000	P3000	P3000	P3000	P1000	P1000	P1000	P5500	P5500	P5000	P5000
2' - 6"	P3000	P3000	P3000	P1000	P1000	P1000	P1000	P1000	P5500	P5500	P5000	P5000
3' - 0"	P1000	P1000	P1000	P1000	P5500	P5500	P5500	P5500	P5500	P5000	P5000	N/A
4' - 0"	P5500	P5500	P5500	P5500	P5500	P5500	P5000	P5000	P5000	P5000	N/A	N/A
5' - 0"	P5500	P5500	P5500	P5500	P5500	P5000	P5000	P5000	P5000	N/A	N/A	N/A
6' - 0"	P5500	P5500	P5500	P5500	P5000	P5000	P5000	P5000	N/A	N/A	N/A	N/A
7' - 0"	P5500	P5000	P5000	P5000	P5000	P5000	P5000	N/A	N/A	N/A	N/A	N/A
8' - 0"	P5000	P5000	P5000	P5000	P5000	N/A	N/A	N/A	N/A	N/A	N/A	N/A
9' - 0"	P5000	P5000	P5000	P5000	N/A	N/A	N/A	N/A	N/A	N/A	N/A	N/A
10' - 0"	P5000	P5000	P5000	N/A	N/A	N/A	N/A	N/A	N/A	N/A	N/A	N/A

Trapeze Span	Double Channel Trapeze for Sch 40 Pipe											
	Pipe Diameter											
	1"	1¼"	1½"	2"	2½"	3"	3½"	4"	5"	6"	8"	10"
1' - 0"	P3001	P3001	P3001	P3001	P3001	P3001	P3001	P3001	P3001	P3001	P3001	P3001
2' - 0"	P3001	P3001	P3001	P3001	P3001	P3001	P3001	P3001	P3001	P3001	P3001	P1001
2' - 6"	P3001	P3001	P3001	P3001	P3001	P3001	P3001	P3001	P3001	P3001	P3001	P1001
3' - 0"	P3001	P3001	P3001	P3001	P3001	P3001	P3001	P3001	P3001	P3001	P5501	P5501
4' - 0"	P3001	P3001	P3001	P3001	P3001	P3001	P3001	P3001	P1001	P5501	P5501	P5501
5' - 0"	P3001	P3001	P3001	P3001	P3001	P3001	P1001	P1001	P5501	P5501	P5501	P5001
6' - 0"	P3001	P3001	P3001	P3001	P1001	P1001	P1001	P5501	P5501	P5501	P5001	P5001
7' - 0"	P3001	P3001	P3001	P1001	P1001	P5501	P5501	P5501	P5501	P5501	P5001	P5001
8' - 0"	P1001	P1001	P1001	P1001	P5501	P5501	P5501	P5501	P5501	P5001	P5001	N/A
9' - 0"	P1001	P1001	P1001	P5501	P5501	P5501	P5501	P5501	P5501	P5001	P5001	N/A
10' - 0"	P1001	P1001	P5501	P5501	P5501	P5501	P5501	P5501	P5001	P5001	N/A	N/A



**ELECTRICAL METALLIC TUBING (EMT) - THIN WALL**

Tubing Size (Nominal) In	Outside Diameter In (mm)	Inside Diameter In (mm)	Weight Of Tubing Lbs/Ft (kg/m)
3/8	0.577	0.497	0.23
	14.7	12.6	0.34
1/2	0.706	0.626	0.29
	17.9	15.9	0.43
3/4	0.922	0.830	0.44
	23.4	21.1	0.65
1	1.163	1.055	0.64
	29.5	26.8	0.95
1 1/4	1.510	1.388	0.95
	38.4	35.3	1.41
1 1/2	1.740	1.618	1.10
	44.2	41.1	1.64
2	2.197	2.075	1.40
	55.8	52.7	2.08
2 1/2	2.875	2.731	2.30
	73.0	69.4	3.42
3	3.500	3.356	2.70
	88.9	85.2	4.02
3 1/2	4.000	3.834	3.40
	101.6	97.4	5.06
4	4.500	4.334	4.00
	114.3	110.1	5.95

**INTERMEDIATE METALLIC CONDUIT (IMC)**

Conduit Size (Nominal) In	Outside Diameter In (mm)	Inside Diameter In (mm)	Weight Of Conduit Lbs/Ft (kg/m)	Weight of Conduit and Conductor Lbs/Ft (kg/m)
1/2	0.815	0.745	0.60	0.12
	20.7	18.9	0.89	0.18
3/4	1.029	0.954	0.82	1.13
	26.1	24.2	1.22	1.68
1	1.290	1.205	1.16	1.82
	32.8	30.6	1.73	2.71
1 1/4	1.638	1.553	1.50	2.67
	41.6	39.4	2.23	3.97
1 1/2	1.883	1.793	1.82	3.42
	47.8	45.5	2.71	5.09
2	2.360	2.266	2.42	5.04
	59.9	57.6	3.60	7.50
2 1/2	2.857	2.727	4.01	7.75
	72.6	69.3	5.97	11.53
3	3.476	3.346	4.43	10.69
	88.3	85.0	6.59	15.91
3 1/2	3.971	3.841	5.73	13.46
	100.9	97.6	8.53	20.03
4	4.466	4.336	6.38	16.37
	113.4	110.1	9.49	24.36

**COPPER TUBE (TYPE L)**

Nom. Tube Size	O.D. Tubing In (mm)	O.D. In (mm)	Wall Thick. In (mm)	Weight Lbs/Ft (kg/m)	Weight Water Lbs/Ft (kg/m)
1/4"	3/8	0.375	0.030	0.126	0.034
	9.5	9.5	0.8	0.19	0.05
3/8"	1/2	0.500	0.035	0.198	0.062
	12.7	12.7	0.9	0.29	0.09
1/2"	5/8	0.625	0.040	0.285	0.100
	15.9	15.9	1.0	0.42	0.15
5/8"	3/4	0.750	0.042	0.362	0.151
	19.1	19.1	1.1	0.54	0.22
3/4"	7/8	0.875	0.045	0.455	0.209
	22.2	22.2	1.1	0.68	0.31
1"	1 1/8	1.125	0.050	0.655	0.357
	28.6	28.6	1.3	0.97	0.53
1 1/4"	1 1/4	1.375	0.055	0.884	0.546
	34.9	34.9	1.4	1.32	0.81
1 1/2"	1 1/2	1.625	0.060	1.140	0.767
	41.3	41.3	1.5	1.70	1.14
2"	2 1/8	2.125	0.070	1.750	1.341
	54.0	54.0	1.8	2.60	2.00
2 1/2"	2 1/4	2.625	0.080	2.480	2.064
	66.7	66.7	2.0	3.69	3.07
3"	3 1/8	3.125	0.090	3.330	2.949
	79.4	79.4	2.3	4.96	4.39
3 1/2"	3 3/8	3.625	0.100	4.290	3.989
	92.1	92.1	2.5	6.38	5.94
4"	4 1/8	4.125	0.110	5.380	5.188
	104.8	104.8	2.8	8.01	7.72
5"	5 1/8	5.125	0.125	7.610	8.081
	130.2	130.2	3.2	11.32	12.03
6"	6 1/8	6.125	0.140	10.200	11.616
	155.6	155.6	3.6	15.18	17.29
8"	8 1/8	8.125	0.200	19.290	20.289
	206.4	206.4	5.1	28.71	30.19
10"	10 1/8	10.125	0.250	30.100	31.590
	257.2	257.2	6.4	44.79	47.01
12"	12 1/8	12.125	0.280	40.400	45.426
	308.0	308.0	7.1	60.12	67.60

**COPPER TUBE (TYPE K)**

Nom. Tube Size	O.D. Tubing In (mm)	O.D. In (mm)	Wall Thick. In (mm)	Weight Lbs/Ft (kg/m)	Weight Water Lbs/Ft (kg/m)
1/4"	3/8	0.375	0.035	0.145	0.032
	9.5	9.53	0.89	0.22	0.05
3/8"	1/2	0.500	0.005	0.269	0.055
	12.7	12.70	0.13	0.40	0.08
1/2"	5/8	0.625	0.049	0.344	0.094
	15.9	15.88	1.24	0.51	0.14
5/8"	3/4	0.750	0.049	0.418	0.144
	19.1	19.05	1.24	0.62	0.21
3/4"	7/8	0.875	0.065	0.641	0.188
	22.2	22.23	1.65	0.95	0.28
1"	1 1/8	1.125	0.065	0.839	0.337
	28.6	28.58	1.65	1.25	0.50
1 1/4"	1 1/4	1.375	0.065	1.040	0.527
	34.9	34.93	1.65	1.55	0.78
1 1/2"	1 1/2	1.625	0.072	1.360	0.743
	41.3	41.28	1.83	2.02	1.11
2"	2 1/8	2.125	0.083	2.060	1.310
	54.0	53.98	2.11	3.07	1.95
2 1/2"	2 1/4	2.625	0.095	2.920	2.000
	66.7	66.68	2.41	4.35	2.98
3"	3 1/8	3.125	0.109	4.000	2.960
	79.4	79.38	2.77	5.95	4.40
3 1/2"	3 3/8	3.625	0.120	5.120	3.900
	92.1	92.08	3.05	7.62	5.80
4"	4 1/8	4.125	0.134	6.510	5.060
	104.8	104.78	3.40	9.69	7.53
5"	5 1/8	5.125	0.160	9.670	8.000
	130.2	130.18	4.06	14.39	11.91
6"	6 1/8	6.125	0.192	13.870	11.200
	155.6	155.58	4.88	20.64	16.67
8"	8 1/8	8.125	0.271	25.900	19.500
	206.4	206.38	6.88	38.54	29.02
10"	10 1/8	10.125	0.338	40.300	30.423
	257.2	257.18	8.59	59.97	45.27
12"	12 1/8	12.125	0.405	57.800	43.675
	308.0	307.98	10.29	86.02	65.00

1 1/8" Channel  
Telestrut  
Nuts & Hardware  
General Fittings  
Pipe/Conduit Supports  
Electrical Fittings  
Concrete Inserts  
Solar  
Unipier®

**Pipe & Conduit Reference Data**

**RIGID STEEL (HEAVY DUTY) CONDUIT**

Conduit Size (Nominal) In	I. D. Of Conduit In (mm)	O. D. Of Conduit In (mm)	O. D. Of Coupling In (mm)	Weight of Conduit Lbs/Ft (kg/m)	Maximum Weight* Of Conduit And Conductor		Not Lead Covered Lbs/Ft (kg/m)
					Lead Covered Lbs/Ft (kg/m)	Lead Covered Lbs/Ft (kg/m)	
½	0.622	0.840	1.063	0.85	1.20	1.00	1.00
	15.8	21.3	27.0	1.26	1.79	1.49	1.49
¾	0.824	1.050	1.297	1.13	1.80	1.40	1.40
	20.9	26.7	32.9	1.68	2.68	2.08	2.08
1	1.049	1.315	1.563	1.68	2.60	2.30	2.30
	26.6	33.4	39.7	2.50	3.87	3.42	3.42
1¼	1.380	1.660	1.969	2.28	4.30	3.60	3.60
	35.1	42.2	50.0	3.39	6.40	5.36	5.36
1½	1.610	1.900	2.234	2.73	5.90	4.50	4.50
	40.9	48.3	56.7	4.06	8.78	6.70	6.70
2	2.067	2.375	2.719	3.68	8.50	7.20	7.20
	52.5	60.3	69.1	5.48	12.65	10.71	10.71
2½	2.469	2.875	3.313	5.82	11.50	10.20	10.20
	62.7	73.0	84.2	8.66	17.11	15.18	15.18
3	3.068	3.500	3.938	7.62	16.50	14.50	14.50
	77.9	88.9	100.0	11.34	24.55	21.58	21.58
3½	3.548	4.000	4.438	9.20	19.00	17.50	17.50
	90.1	101.6	112.7	13.69	28.28	26.04	26.04
4	4.026	4.500	4.938	10.89	24.80	21.50	21.50
	102.3	114.3	125.4	16.21	36.91	32.00	32.00
5	5.047	5.563	6.296	14.81	35.90	30.80	30.80
	128.2	141.3	159.9	22.04	53.43	45.84	45.84
6	6.065	6.625	7.358	19.19	50.70	43.40	43.40
	154.1	168.3	186.9	28.56	75.45	64.59	64.59

\* Maximum weight equals weight of rigid conduit plus weight of heaviest conductor combination (from the National Electrical Code Handbook.)

**WATER FILLED PIPE SUPPORT SPACING**

Nominal Pipe Size In	Max. Span Ft (m)	Nominal Pipe Size In	Max. Span Ft (m)
1	7 2.13	8	19 5.79
1½	9 2.74	10	22 6.71
2	10 3.05	12	23 7.01
2½	11 3.35	14	25 7.62
3	12 3.66	16	27 8.23
3½	13 3.96	18	28 8.53
4	14 4.27	20	30 9.14
5	16 4.88	24	32 9.75

The above spacing based on a combined bending and shear stress of 1500 PSI when pipe is filled with water and the pitch of the line is such that a sag of 0.1 in. between supports is permissible.

**CONDUIT SUPPORT SPACING**

346-12. Supports. Rigid metal conduit shall be installed as a complete system as provided in Article 344 and shall be securely fastened in place. Conduit shall be firmly fastened within 3 feet (914.4 mm) of each outlet box, junction box, cabinet, or fitting. Conduit shall be supported at least every 10 feet (3.05 m).

*Exception: If made up with threaded couplings, it shall be permissible to support straight runs of rigid metal conduit in accordance with Table 344.30 (B)(2), provided such supports prevent transmission of stresses to termination where conduit is deflected between supports.*

Table 344.30 (B)(2)  
Support for Rigid Metal Conduit

Conduit Size In (mm)	Maximum Distance Between Supports Ft (m)
½-¾	10
12.7 - 19.1	3.05
1	12
25.4	3.66
1¼- 1½	14
31.8 - 38.1	4.27
2- 2½	16
50.8 - 63.5	4.88
3 & larger	20
76.2 - Larger	6.10

**SCHEDULE 40: PVC PLASTIC PIPE**

Pipe Size (Nominal) In	Outside Diameter In (mm)	Inside Diameter In (mm)	Pipe Weight Lbs/Ft (kg/m)	Pipe and Water Weight Lbs/Ft (kg/m)
¼	0.540	0.354	0.081	0.12
	13.7	9.0	0.12	0.18
⅜	0.675	0.483	0.109	0.19
	17.1	12.3	0.16	0.28
½	0.840	0.608	0.161	0.29
	21.3	15.4	0.24	0.43
¾	1.050	0.810	0.214	0.44
	26.7	20.6	0.32	0.65
1	1.315	1.033	0.315	0.68
	33.4	26.2	0.47	1.01
1¼	1.660	1.364	0.426	1.06
	42.2	34.6	0.63	1.58
1½	1.900	1.592	0.509	1.37
	48.3	40.4	0.76	2.04
2	2.375	2.049	0.682	2.11
	60.3	52.0	1.01	3.14
2½	2.875	2.445	1.076	3.11
	73.0	62.1	1.60	4.63
3	3.500	3.042	1.409	4.55
	88.9	77.3	2.10	6.77
4	4.500	3.998	2.006	7.44
	114.3	101.5	2.99	11.07
6	6.625	6.031	3.535	15.90
	168.3	153.2	5.26	23.66
8	8.625	7.943	5.305	26.75
	219.1	201.8	7.89	39.81
10	10.750	9.976	7.532	41.35
	273.1	253.4	11.21	61.54



**DATA FOR SCHEDULE STEEL PIPE**

Nom. Size In	Pipe Schedule	Outside Dia. In (mm)	Inside Dia. In (mm)	Pipe Weight Lbs/Ft (kg/m)	Pipe and Water Weight Lbs/Ft (kg/m)
1/8	40	0.405 10.3	0.269 6.8	0.24 0.36	0.27 0.40
	80	0.405 10.3	0.215 5.5	0.31 0.46	0.33 0.49
1/4	40	0.540 13.7	0.364 9.2	0.42 0.63	0.47 0.70
	80	0.540 13.7	0.302 7.7	0.53 0.79	0.57 0.85
3/8	40	0.675 17.1	0.493 12.5	0.57 0.85	0.65 0.97
	80	0.675 17.1	0.423 10.7	0.74 1.10	0.80 1.19
1/2	40	0.840 21.3	0.622 15.8	0.85 1.26	0.98 1.46
	80	0.840 21.3	0.546 13.9	1.09 1.62	1.19 1.77
	160	0.840 21.3	0.464 11.8	1.31 1.95	1.38 2.05
3/4	40	1.050 26.7	0.824 20.9	1.13 1.68	1.36 2.02
	80	1.050 26.7	0.742 18.8	1.47 2.19	1.66 2.47
	160	1.050 26.7	0.612 15.5	1.94 2.89	2.07 3.08
1	40	1.315 33.4	1.049 26.6	1.68 2.50	2.05 3.05
	80	1.315 33.4	0.957 24.3	2.17 3.23	2.48 3.69
	160	1.315 33.4	0.815 20.7	2.84 4.23	3.07 4.57
1 1/4	40	1.660 42.2	1.380 35.1	2.27 3.38	2.92 4.35
	80	1.660 42.2	1.278 32.5	2.99 4.45	3.55 5.28
	160	1.660 42.2	1.160 29.5	3.76 5.60	4.22 6.28
1 1/2	40	1.900 48.3	1.610 40.9	2.71 4.03	3.60 5.36
	80	1.900 48.3	1.500 38.1	3.63 5.40	4.39 6.53
	160	1.900 48.3	1.338 34.0	4.85 7.22	5.46 8.13
2	40	2.375 60.3	2.067 52.5	3.65 5.43	5.10 7.59
	80	2.375 60.3	1.939 49.3	5.02 7.47	6.30 9.38
	160	2.375 60.3	1.687 42.8	7.45 11.09	8.42 12.53
2 1/2	40	2.875 73.0	2.469 62.7	5.79 8.62	7.86 11.70
	80	2.875 73.0	2.323 59.0	7.65 11.38	9.49 14.12
	160	2.875 73.0	2.125 54.0	10.00 14.88	11.54 17.17
3	40	3.500 88.9	3.068 77.9	7.57 11.27	10.77 16.03
	80	3.500 88.9	2.900 73.7	10.24 15.24	13.11 19.51
	160	3.500 88.9	2.624 66.6	14.31 21.30	16.65 24.78
3 1/2	40	4.000 101.6	3.548 90.1	9.10 13.54	13.39 19.93
	80	4.000 101.6	3.364 85.4	12.49 18.59	16.35 24.33

Nom. Size In	Pipe Schedule	Outside Dia. In (mm)	Inside Dia. In (mm)	Pipe Weight Lbs/Ft (kg/m)	Pipe and Water Weight Lbs/Ft (kg/m)
4	40	4.500 114.3	4.026 102.3	10.78 16.04	16.30 24.26
	80	4.500 114.3	3.826 97.2	14.97 22.28	19.95 29.69
	120	4.500 114.3	3.624 92.0	18.98 28.25	23.45 34.90
5	160	4.500 114.3	3.438 87.3	22.48 33.45	26.51 39.45
	40	5.563 141.3	5.047 128.2	14.60 21.73	23.27 34.63
	80	5.563 141.3	4.813 122.2	20.75 30.88	28.64 42.62
6	120	5.563 141.3	4.563 115.9	27.01 40.20	34.09 50.73
	160	5.563 141.3	4.313 109.5	32.92 48.99	39.26 58.43
	40	6.625 168.3	6.065 154.1	18.95 28.20	31.48 46.85
8	80	6.625 168.3	5.761 146.3	28.54 42.47	39.84 59.29
	120	6.625 168.3	5.501 139.7	36.35 54.09	46.66 69.44
	160	6.625 168.3	5.187 131.7	45.30 67.41	54.47 81.06
10	20	8.625 219.1	8.125 206.4	22.34 33.25	44.82 66.70
	30	8.625 219.1	8.071 205.0	24.67 36.71	46.85 69.72
	40	8.625 219.1	7.981 202.7	28.52 42.44	50.21 74.72
12	60	8.625 219.1	7.813 198.5	35.60 52.98	56.39 83.92
	80	8.625 219.1	7.625 193.7	43.34 64.50	63.14 93.96
	100	8.625 219.1	7.437 188.9	50.89 75.73	69.73 103.77
14	120	8.625 219.1	7.187 182.5	60.65 90.26	78.23 116.42
	140	8.625 219.1	7.001 177.8	67.68 100.72	84.37 125.56
	160	8.625 219.1	6.813 173.1	74.61 111.03	90.42 134.56
16	20	10.750 273.1	10.250 260.4	28.01 41.68	63.78 94.92
	30	10.750 273.1	10.136 257.5	34.20 50.90	69.19 102.97
	40	10.750 273.1	10.020 254.5	40.44 60.18	74.63 111.06
18	60	10.750 273.1	9.750 247.7	54.68 81.37	87.05 129.54
	80	10.750 273.1	9.562 242.9	64.36 95.78	95.50 142.12
	100	10.750 273.1	9.312 236.5	76.95 114.51	106.47 158.44
20	120	10.750 273.1	9.062 230.2	89.20 132.74	117.16 174.35
	140	10.750 273.1	8.750 222.3	104.02 154.80	130.09 193.60
	160	10.750 273.1	8.500 215.9	115.52 171.91	140.13 208.54

# ELECTRICAL FITTINGS

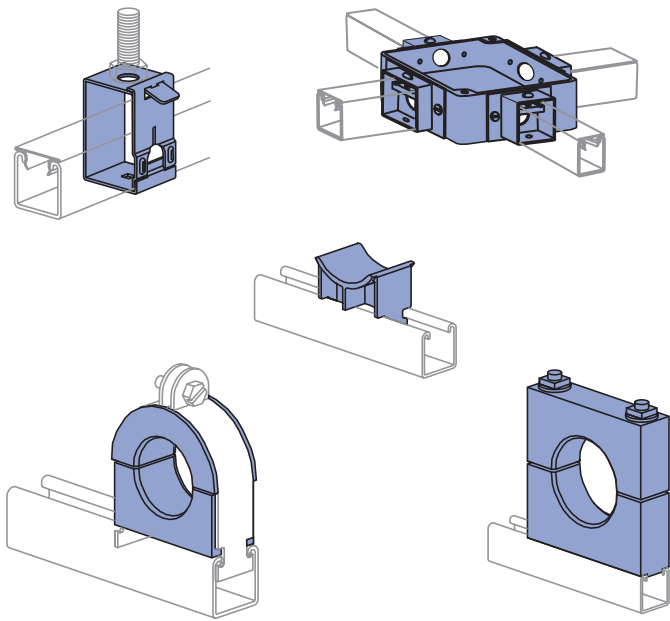

Electrical Fittings.....	128 - 130
Receptacles.....	131
Fixture Hangers.....	131
Accessories and Connectors.....	132
Junction Boxes.....	132
In-Channel Joiners.....	133
Swivel Hangers.....	133
Cable Entrance Tubing and Accessories.....	134 - 136
Electrical Fittings Technical Data.....	137 - 138

## MATERIAL

Unistrut fittings, unless noted, are made from hot-rolled, pickled and oiled steel plates, strip, bar or coil, and conform to one or more of the following specifications:

ASTM A575, A576, A635, A1011 SS GR 33, A1011 HSLAS GR 45 or A36. The fitting steel also meets or exceeds the physical requirements of ASTM A1011 SS GR 33.

Maple cable saddles, cable clamps and bus bar clamps are made from kiln-dry maple treated with paraffin to a depth of 1/16" (1.6mm). Special sizes of clamps can be fabricated upon request. Cable saddles are fiberglass-reinforced polyester.

## CHANNEL RACEWAYS

The Unistrut Metal Framing System includes an exclusive combination of channel, fittings and hardware listed under new UL classification 5B. This classification covers strut-type channel raceways and fittings for use in accordance with Article 384 of the National Electrical Code, NFPA 70.

Included are metal strut-type channel raceways at least .071 inch (1.81mm) thick and metal or non-metal closure strips at least .040 inch (1.02mm) thick.

The Unistrut system requires no welding, drilling or other complex fabrication techniques. This means faster, easier solutions for virtually any electrical support problem.

Unistrut channel offers structural and spanning capabilities not available with conventional surface raceway products and is available in continuous lengths of up to 20 feet. Just as important, it is part of an integrated system that can be used for raceways, trapeze hangers, cable-tray supports, lighting grids, fluorescent-fixture supports and countless other electrical applications.

## CHANNEL COMPATABILITY

All of the electrical components in this section are intended for use with any of the 1 5/8" wide channel. They are not intended for use with 1 1/4" or 1 3/16" framing systems.

## FINISHES

Components listed in this section are available in:

Electro-galvanized (EG), conforming to ASTM B633 Type III SC1;

Hot-dipped galvanized (HG), conforming to ASTM A123 or A153,

Green Powder Coat (GR), conforming to commercial standards for Powder Coating

Plain (PL)

Note: Many Unistrut Metal Framing components, when used with appropriate closures, are UL® listed, and CSA approved.

## DESIGN LOAD

Design load data, where shown, is based on the ultimate strength of the connection with a safety factor of 2.5, unless otherwise noted.

## DIMENSIONS

Imperial dimensions are illustrated in inches. Metric dimensions are shown in parenthesis or as noted. Unless noted, all metric dimensions are in millimeters and rounded to one decimal place.

## LISTINGS

UL File No. - E19459	Channel & Closure Strips
UL File No. - E25629	Fittings
CSA File No. - 013669	All Products



1 1/8" Channel

Telestrut

Nuts & Hardware

General Fittings

Pipe/Conduit Supports

Electrical Fittings

Concrete Inserts

Solar

Unipier®

**Electrical Fittings**

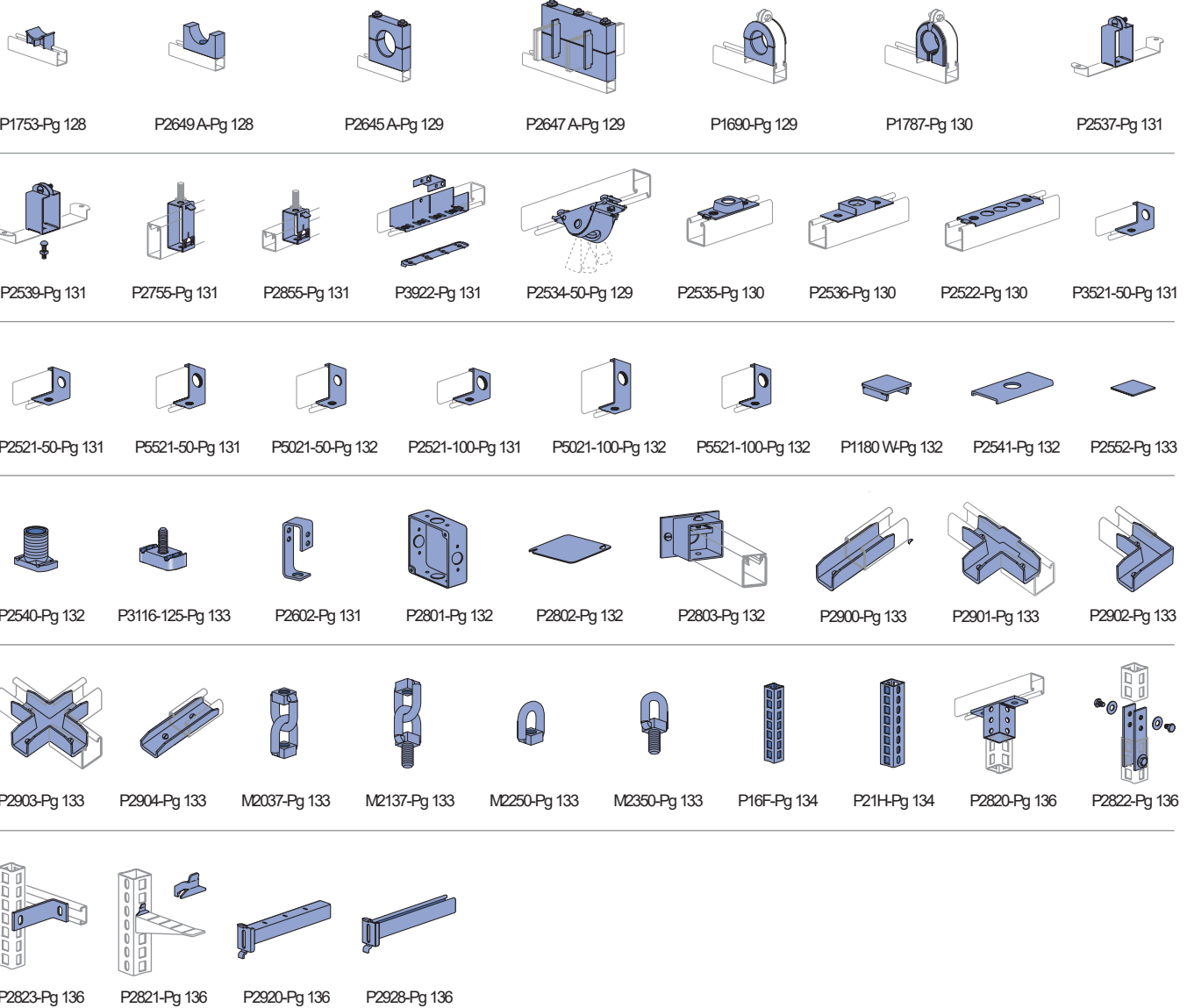

**P2649A THRU P2649H**

**MAPLE CABLE SADDLES**

**P1753, P1754 CABLE SADDLES**

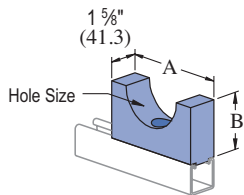

- 3/8" Flat Head Machine Screw included.
  - Specify hole size when ordering.
  - Order channel nuts as required.
- Material: Paraffin impregnated maple hardwood.

Part No.	Hole Size In (mm)	"A" In (mm)	"B" In (mm)	Wt/100 pcs Lbs (kg)
P2649A	0 - 1	3	1 3/4	31
P2649B	0 - 25.4	76.2	44.5	14.1
P2649C	1 - 1 1/2	3 1/2	2	38
P2649D	25.4 x 38.1	88.9	50.8	17.2
P2649E	1 1/2 - 2	4	2 1/4	47
P2649F	38.1 - 50.8	101.6	57.2	21.3
P2649G	2 - 2 1/2	4 1/2	2 1/2	57
P2649H	50.8 x 63.5	114.3	63.5	25.9
P2649I	2 1/2 - 3	5	2 3/4	68
P2649J	63.5 - 76.2	127.0	69.9	30.8
P2649K	3 - 3 1/2	5 1/2	3	80
P2649L	76.2 x 88.9	139.7	76.2	36.3
P2649M	3 1/2 - 4	6	3 1/4	94
P2649N	88.9 - 101.6	152.4	82.6	42.6
P2649O	over 4			
P2649P	over 101.6			

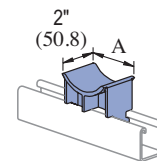

Part Number	"A" In (mm)	Maximum Cable Dia. In (mm)	Wt/100 pcs Lbs (kg)
P1753 FG	2 13/16	3	12
P1754 FG	71.4	76.2	5.4
P1753 PO	3 3/4	4 1/2	17
P1754 PO	95.3	114.3	7.7
P1753 PO	3	3	75
P1754 PO	76.2	76.2	34.0
P1753 PO	4	4 1/2	95
P1754 PO	101.6	114.3	43.1

Material: FG - Fiberglass Reinforced Polyester, PO - Dry Process White Glazed Porcelain



**Electrical Fittings**

**P2645A THRU P2645H**

**MAPLE CABLE CLAMPS**

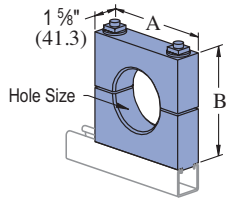

- 3/8" studs, square nuts and washers included.
  - Specify hole size when ordering.
  - Order channel nuts as required.
- Material: Paraffin impregnated maple hardwood.

Part No.	Hole Size In (mm)	"A" & "B" Dimensions In (mm)	Wt/100 pcs Lbs (kg)
P2645A	0 - 1	3 1/2	84
P2645B	0 - 25.4	88.9	38.1
P2645C	1 - 1 1/2	4	102
P2645D	1 1/2 - 2	4 1/2	121
P2645E	2 - 2 1/2	5 1/2	165
P2645F	2 1/2 - 3	6	189
P2645G	3 - 3 1/2	6 1/2	215
P2645H	3 1/2 - 4	7	243
	over 4	-	-
	over 101.6	-	-

**P2647A THRU P2647F**

**4" (101.6) BUS BAR MAPLE CLAMPS**

- 1/2" studs, square nuts and washers are included.
  - Channel nuts must be ordered separately.
  - Bus bar maple clamps also available in 1/4" (6.4) x 2" (50.8) and 1/4" (6.4) x 6" (152.4).
- Material: Paraffin impregnated maple hardwood.

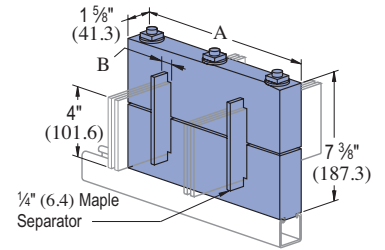

Part No.	"A" In (mm)	"B" In (mm)	No. Bus Separators	No. Bars Per Leg	Wt/100 pcs Lbs (kg)
P2647A	8 1/2 215.9	9/32 7.1	0	1	421 191.0
P2647B	9 1/2 241.3	13/16 20.6	2	2	465 210.9
P2647C	10 1/2 266.7	15/16 33.3	4	3	509 230.9
P2647D	11 1/2 292.1	1 13/16 46.0	6	4	553 250.8
P2647E	12 1/2 317.5	2 3/8 60.3	8	5	597 270.8
P2647F	13 1/2 342.9	2 1/2 73.0	10	6	631 286.2

**P1690 THRU P1697**

**MAPLE CABLE CLAMPS**

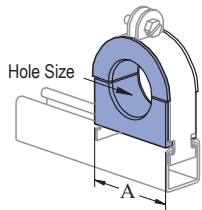

- Use with steel clamp and Everdur hardware. Order clamp separately.
  - Specify hole size when ordering.
- Material: Paraffin impregnated maple hardwood.

Part No.	Steel Clamp No.	Hole Size In (mm)	"A" In (mm)	Wt/100 pcs Lbs (kg)
P1690	P1113 E	0 - 5/8 0 - 15.9	1 5/16 33.3	24 10.9
P1691	P1115 E	1/2 - 1 12.7 - 25.4	1 15/16 49.2	42 19.1
P1692	P1117 E	3/4 - 1 1/2 19.1 x 38.1	2 3/8 60.3	54 24.5
P1693	P1118 E	1 1/4 - 1 3/4 31.8 x 44.5	2 3/8 73.0	65 29.5
P1694	P1119 E	1 1/2 - 2 1/4 38.1 x 57.2	3 1/2 88.9	84 38.1
P1695	P1120 E	2 - 2 1/2 50.8 x 63.5	4 101.6	107 48.5
P1696	P1121 E	2 1/4 - 3 57.2 - 76.2	4 1/2 114.3	123 55.8
P1697	P1123 E	3 - 4 76.2 - 101.6	5 9/16 141.3	163 73.9

**P2534-50, P2534-75**

**CONDUIT SWING FITTING**

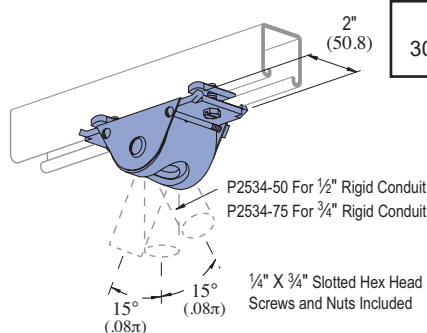

Design Load  
300 Lbs (1.33 kN)

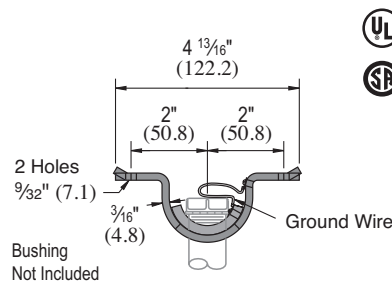

- Conduit hanger fittings allow a free swivel of 15° in one direction.
- Fitting may be mounted to the slot side of the Unistrut channel or to the back.

Wt/100 pcs: 96 Lbs (43.5 kg)



**P1787 THRU P1795**

**POURCE-A-CLAMP™**

1 1/8" Channel

Telestrut

Nuts & Hardware

General Fittings

Pipe/Conduit Supports

Electrical Fittings

Concrete Inserts

Solar

Unipier®

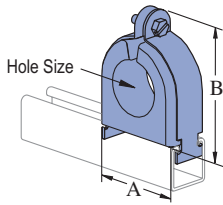

Patents Pending  
Strap Material:  
Electro-galvanized Steel (EG) or  
Stainless Steel (SS)  
Use With: All 1 1/8" channel

- Porce-A-Clamp™**
- Non-Breakable TPE Material.
  - U.V. Resistant.
  - U.L. Listed.
  - Optional Stainless Steel Clamps.
  - Tapered Flange to Protect Cable.
  - Dielectric Strength 640 Volts Per Mil.
  - One Piece Insulator.
  - Replaces Porcelain & Maple Cable Clamp.
  - For use in accordance with National Electrical Code ANSI/NFPA 70.
  - Includes Pipe Strap.
  - Temperature Rating -50°F to +275°F (-45°C to +135°C)

Part Number	Hole Size In (mm)	"A" In (mm)	"B" In (mm)	Wt/100 pcs Lbs (kg)
P1787A	3/8 9.5	1.36 34.5	1.82 46.2	25 11.3
P1787B	1/2 12.7			
P1787C	5/8 15.9			
P1788	3/4 19.1	1.86 47.2	2.34 59.4	37 16.8
P1788A	7/8 22.2			
P1788B	1 25.4			
P1788C	1 1/8 28.6	2.36 59.9	2.86 72.6	58 26.3
P1789	1 1/4 31.8			
P1789A	1 3/8 34.9			
P1789B	1 1/2 38.1	2.86 72.6	3.50 88.9	76 34.5
P1789C	1 5/8 41.3			
P1790	1 3/4 44.5			
P1790A	1 7/8 47.6	2.86 72.6	3.50 88.9	76 34.5
P1790B	2 50.8			
P1790C	2 1/8 54.0			
P1791	2 1/4 57.2	3.36 835	4.05 102.9	90 40.8
P1791A	2 3/8 60.3			

Part Number	Hole Size In (mm)	"A" In (mm)	"B" In (mm)	Wt/100 pcs Lbs (kg)
P1791B	2 1/2 63.5	3.36 85.3	4.05 102.9	90 40.8
P1791C	2 5/8 66.7			
P1792	2 3/4 69.9			
P1792A	2 7/8 73.0	3.86 98.0	4.75 120.7	109 49.4
P1792B	3 76.2			
P1792C	3 1/8 79.4			
P1793	3 1/4 82.6	4.36 110.7	5.125 130.2	130 59.0
P1793A	3 3/8 85.7			
P1793B	3 1/2 88.9			
P1793C	3 5/8 92.1	4.86 123.4	5.54 140.7	160 72.6
P1794	3 3/4 95.3			
P1794A	3 7/8 98.4			
P1794B	4 101.6	5.24 133.1	5.92 150.4	160 72.6
P1794C	4 1/8 104.8			
P1795	4 1/4 108.0			
P1795A	4 3/8 111.1	5.24 133.1	5.92 150.4	160 72.6
P1795B	4 1/2 114.3			

**P2535**  
**CONDUIT HANGER CONNECTION**  
**FOR 1/2" CONDUIT**

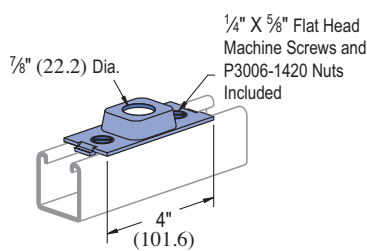

1/4" X 5/8" Flat Head Machine Screws and P3006-1420 Nuts Included

**Design Load**  
400 Lbs (1.78 kN)

Material: 12 gauge (2.7).

Wt/100 pcs: 28 Lbs (12.7 kg)

**P2536**  
**CONDUIT HANGER CONNECTION**  
**FOR 3/4" CONDUIT**

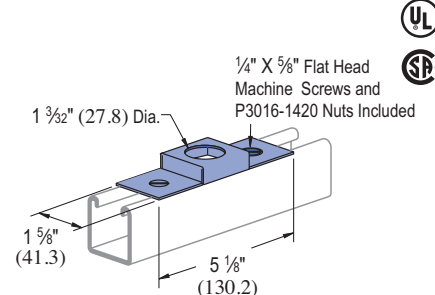

1/4" X 5/8" Flat Head Machine Screws and P3016-1420 Nuts Included

**Design Load**  
200 Lbs (0.89 kN)

Material: 16 gauge (1.5)

Wt/100 pcs: 36 Lbs (16.3 kg)

**P2522** **OUTLET BOX CONNECTION**

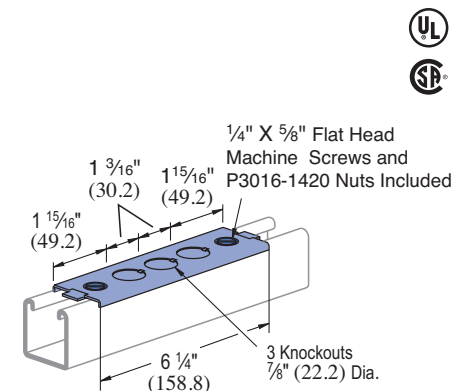

1/4" X 5/8" Flat Head Machine Screws and P3016-1420 Nuts Included

Wt/100 pcs: 35 Lbs (15.9 kg)

**Receptacles & Fixture Hangers**

**P2755, P2756, P2757**  
**RACEWAY HANGERS**

UL SF

Design Load  
120 Lbs (0.53 kN)

Part No.	"A" In (mm)	Wt/100 pcs Lbs (kg)
P2755	9/16 14.3	44 20.0
P2756	7/8 22.2	44 20.0
P2757	1 1/32 10.3	44 20.0

Use with Channels:  
P1001, P1101, P2001, P5000, & P5500.  
Material: 14 gauge (1.9).

**P2855, P2856, P2857**  
**RACEWAY HANGERS**

UL SF

Design Load  
120 Lbs (0.53 kN)

Part No.	"A" In (mm)	Wt/100 pcs Lbs (kg)
P2855	9/16 14.3	32 14.5
P2856	7/8 22.2	32 14.5
P2857	1 1/32 10.3	32 14.5

Use with Channels:  
P1000, P1100, P3000, P3300  
Material: 14 gauge (1.9).

**P2537, P5537**  
**FLUORESCENT FIXTURE HANGERS**

UL SF

Design Load  
120 Lbs (0.53 kN)

- Hanger provides more than 1/2" (12.7) space between channel and fixtures.

Materials: 18 gauge (1.2).

**P2602** **MERCURY VAPOR FIXTURE HANGER**

Use with 1 1/8" Channel  
Finish: Electro-galvanized  
Stock Size: 1/4"  
NOTE: Supports fixture in slot up or down system.

Where swivel joint is required

Wt/100 pcs: 154 Lbs (69.9 kg)

Part No.	Use w/Channel	"A" In (mm)	Wt/100 pcs Lbs (kg)
P2537	P1000	2 1/16	19
	P1100	61.9	8.6
	P3000		
P5537	P5500	3 1/4	22
		82.6	10.0

**P2539, P3539, P5539**  
**FLUORESCENT FIXTURE HANGERS**

UL SF

Design Load  
120 Lbs (0.53 kN)

- Hanger provides 1/8" (3.2) space between channel and fixtures.

Materials: 18 gauge (1.2).

**P3922 THRU P3926** **SPLICE FITTINGS**

P2869 14 (2) Gauge

Material: 16 gauge (1.6).

Assy. No.	Use W/ Channel	"A" In (mm)	Clevis No.	Back Clevis No.	Plate Nut No.	Wt/100 pcs Lbs (kg)
P3922	P1000	1 1/8	P2377	P2517	P2869	100
	P1100	41.3				45.4
P3923	P3000	1 3/8	P3377	P2517	P2869	97
		34.9				44.0
P3924	P4000	1 1/16	P5377	P2517	P2869	80
		20.6				36.3
P3925	P5500	1 1/8	P2377	P5517	P2869	103
		41.3				46.7
P3926	P5000	1 1/8	P2377	P5017	P2869	106
		41.3				48.1

**P3521-50**  
**END CONNECTORS FOR 1/2" CONDUIT**

UL SF

Material: 12 gauge (3).  
Wt/100 pcs: 27 Lbs (12.2 kg)

**P2521-50, P2521-75**  
**END CONNECTORS FOR 1/2" & 3/4" CONDUIT**

UL SF

Part No.	Conduit Size In	Wt/100 pcs Lbs (kg)
P2521-50	1/2	27 12.2
P2521-75	3/4	26 11.8

Use with channels:  
P1000 and P1100.  
Material:  
12 gauge (3)

**P5521-50, P5521-75**  
**END CONNECTORS FOR 1/2" & 3/4" CONDUIT**

UL SF

Part No.	Conduit Size In	Wt/100 pcs Lbs (kg)
P5521-50	1/2	27 12.2
P5521-75	3/4	26 11.8

Material:  
12 gauge (3).



1 1/8" Channel

Telestrut

Nuts & Hardware

General Fittings

Pipe/Conduit Supports

Electrical Fittings

Concrete Inserts

Solar

Unipier®

**P5021-50, P5021-75 END CONNECTOR FOR 1/2" & 3/4" CONDUIT**

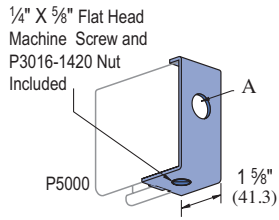

Part No.	Conduit Size A In	Wt/100 pcs Lbs (kg)
P5021-50	1/2	31 14.1
P5021-75	3/4	30 13.6

Material: 12 gauge (2.7).

**P2521-100 END CONNECTOR FOR 1" CONDUIT**

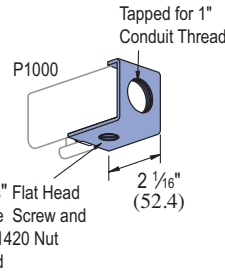

Material: 12 gauge (2.7).

W/100 pcs: 24 Lbs (10.9 kg)

**P5021-100 END CONNECTOR FOR 1" CONDUIT**

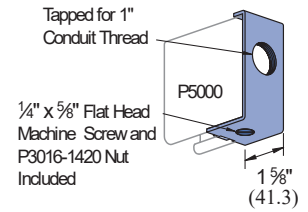

Material: 12 gauge (2.7).

W/100 pcs: 28 Lbs (12.7 kg)

**P5521-100 END CONNECTOR FOR 1" CONDUIT**

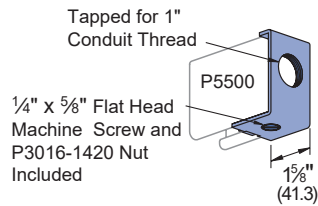

Material: 12 gauge (2.7).

W/100 pcs: 24 Lbs (10.9 kg)

**P2541**

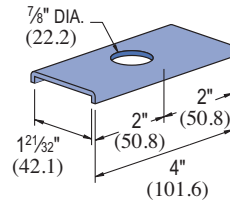

Material: 12 gauge (2.7).

W/100 pcs: 24 Lbs (10.9 kg)

**SPACER CLEVIS**



**P1180W THRU P5580W END CAPS**

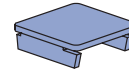

Material: 14 gauge (1.9)

Part Number	Use With	Wt/100 pcs Lbs (kg)
P1180W	P1100	12 (5.4)
P1280W	P1000	11 (5.0)
P2280W	P2000	11 (5.0)
P3280W	P3000	8 (3.6)
P4280W	P4000	5 (2.3)
P5280W	P5000	22 (10.0)
P5580W	P5500	18 (8.2)

**P2540, P2540A**

**WIRING STUD NUT**

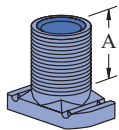

Stamped Ident. No.  
P2540 - 121961  
P2540A - 121960  
Material: Sintered metal.

1/2" American Standard Straight Pipe Thread



Part No.	"A" In (mm)	Wt/100 pcs Lbs (kg)
P2540	1 5/64	10.0
	27.4	4.5
P2540A	5/8	8
	15.9	3.6

Design Load  
320 Lbs (1.42 kN)

**P2801**

**JUNCTION BOX**

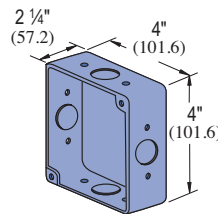

W/100 pcs: 113 Lbs (51.4 kg)



**P2802 JUNCTION BOX COVER**

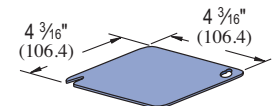

W/100 pcs: 30 Lbs (13.6 kg)



**P2803**

**HUB ASSEMBLY**

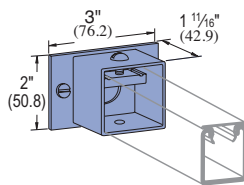

Stamp ID No. 122022

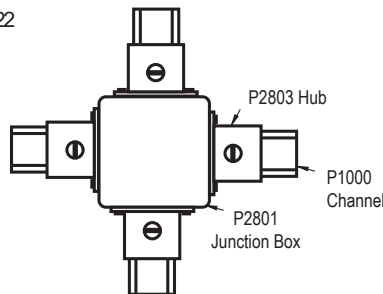

Note: Combine junction box (P2801) and hub assemblies (P2803) to make 1, 2, 3, or 4 way junction box.

W/100 pcs: 32 Lbs (14.5 kg)

## P3116-125 FIXTURE STUD NUT

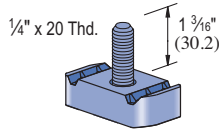

Wt/100 pcs: 11 Lbs (5.0 kg)

## P2900

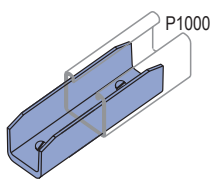

3/8"-16 x 1/4" Socket Cup Point  
Set Screws Included  
Material: Cast aluminum

Wt/100 pcs: 20 Lbs (9.1 kg)

## M2037, M2050

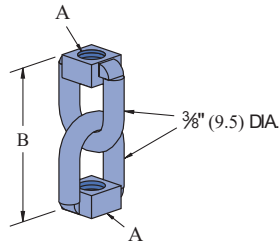

Design Load  
600 Lbs (2.67 kN)

Part No.	"A" In	"B" In (mm)	Wt/100 pcs Lbs (kg)
M2037	3/8" - 16	2 9/32 75.4	23 10.4
M2050	1/2" - 13	2 3/4 69.9	32 14.5

## M2137, M2150

## SWIVEL HANGERS

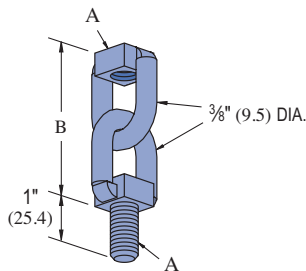

Design Load  
600 Lbs (2.67 kN)

Part No.	"A" In	"B" In (mm)	Wt/100 pcs Lbs (kg)
M2137	3/8" - 16	2 9/32 74	27 12.2
M2150	1/2" - 13	2 3/4 69.9	45 20.4

## P2552

## POLYPROPYLENE WIRE RETAINER

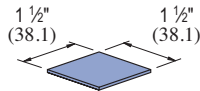

Retainer may be easily pushed into channel to support wires until closure strip is installed.

Wt/100 pcs: .30 Lbs (.1 kg)

## P2901

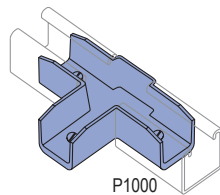

3/8"-16 x 1/4" Socket Cup Point  
Set Screws Included  
Material: Cast aluminum

Wt/100 pcs: 35 Lbs (15.9 kg)

## P2902

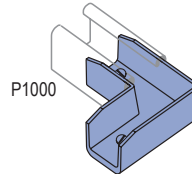

3/8"-16 x 1/4" Socket Cup Point  
Set Screws Included  
Material: Cast aluminum

Wt/100 pcs: 27 Lbs (12.2 kg)

## M2250

## SWIVEL HANGER

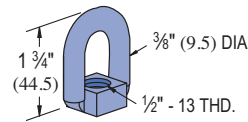

Design Load  
600 Lbs (2.67 kN)

Wt/100 pcs: 18 Lbs (8.2 kg)

## M2350

## SWIVEL HANGER

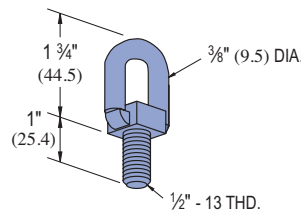

Design Load  
600 Lbs (2.67 kN)

Wt/100 pcs: 20 Lbs (9.1 kg)

## P2904



P3300, P4000, P4100

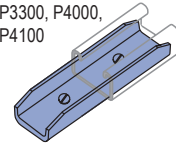

3/8"-16 x 1/4" Socket Cup Point  
Set Screws Included  
Extruded Aluminum

Wt/100 pcs: 12 Lbs (5.4 kg)

## P2903

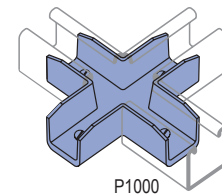

3/8"-16 x 1/4" Socket Cup Point  
Set Screws Included  
Material: Cast aluminum

Wt/100 pcs: 45 Lbs (20.4 kg)



**P16F**

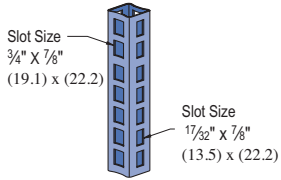

Slot spacing  
1/4" (31.8)  
on center.

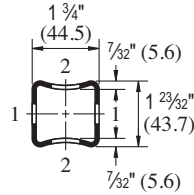

Tubing Finishes: PL, GR, HG, PG;  
Standard Lengths: 10' & 20'

Wt/100 Ft: 178 Lbs (260 kg/100 m)  
Allowable Moment 4,800 In-Lbs (540 N•m)  
12 Gauge Nominal Thickness .105" (2.7mm)

**P16F - COLUMN LOADING**

Unbraced Height In	Max. Allowable Load Column Loaded at C.G. Lbs	Max. Allowable Load Column Loaded at Slot Face Lbs
24	9,600	3,300
36	9,000	3,100
48	8,300	2,900
60	7,500	2,700
72	6,600	2,400
84	5,600	2,200
96	4,500	1,900
108	3,600	1,600
120	2,900	1,400
144	2,000	1,100

**P16F - COLUMN LOADING (METRIC)**

Unbraced Height mm	Max. Allowable Load Column Loaded at C.G. kN	Max. Allowable Load Column Loaded at Slot Face kN
610	42.7	14.7
914	40.0	13.8
1,219	36.9	12.9
1,524	33.4	12.0
1,829	29.4	10.7
2,134	24.9	9.8
2,438	20.0	8.5
2,743	16.0	7.1
3,048	12.9	6.2
3,658	8.9	4.9

**P21H**

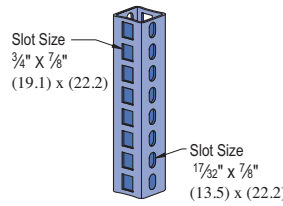

Slot spacing  
1/4" (31.8)  
on center.

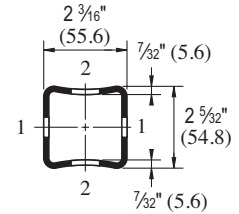

Tubing Finishes: PL, GR, HG, PG;  
Standard Lengths: 10' & 20'

Wt/100 Ft: 297 Lbs (440 kg/100 m)  
Allowable Moment 11,370 In-Lbs (540 N•m)  
12 Gauge Nominal Thickness .105" (2.7mm)

**P21H - COLUMN LOADING**

Unbraced Height In	Max. Allowable Load Column Loaded at C.G. Lbs	Max. Allowable Load Column Loaded at Slot Face Lbs
24	17,700	6,200
36	16,900	6,000
48	16,000	5,700
60	15,000	5,400
72	13,900	5,100
84	12,600	4,700
96	11,300	4,300
108	9,900	3,900
120	8,300	3,500
144	5,800	2,800
168	4,230	2,300

**P21H - COLUMN LOADING (METRIC)**

Unbraced Height mm	Max. Allowable Load Column Loaded at C.G. kN	Max. Allowable Load Column Loaded at Slot Face kN
610	78.7	27.6
914	75.2	26.7
1,219	71.2	25.4
1,524	66.7	24.0
1,829	61.8	22.7
2,134	56.0	20.9
2,438	50.3	19.1
2,743	44.0	17.3
3,048	36.9	15.6
3,658	25.8	12.5
4,267	18.8	10.2

# Cable Entrance Tubing

## P16F - BEAM LOADING

Span In	Max Allowable Uniform Load Lbs	Defl. at Uniform Load In	Uniform Loading at Deflection		
			Span/180 Lbs	Span/240 Lbs	Span/360 Lbs
24	1,600	0.06	1,600	1,600	1,600
36	1,070	0.13	1,070	1,070	820
48	800	0.23	800	690	460
60	640	0.36	590	440	290
72	530	0.52	410	310	200
84	460	0.71	300	220	150
96	400	0.93	230	170	110
108	360	1.18	180	140	90
120	320	1.45	150	110	70
144	270	2.09	100	80	50
168	230	2.85	70	60	40

## P21H - BEAM LOADING

Span In	Max Allowable Uniform Load Lbs	Defl. at Uniform Load In	Uniform Loading at Deflection		
			Span/180 Lbs	Span/240 Lbs	Span/360 Lbs
24	3,790	0.05	3,790	3,790	3,790
36	2,530	0.11	2,530	2,530	2,380
48	1,900	0.19	1,900	1,900	1,340
60	1,520	0.29	1,520	1,280	860
72	1,260	0.42	1,190	890	590
84	1,080	0.58	870	660	440
96	950	0.76	670	500	330
108	840	0.96	530	400	260
120	760	1.18	430	320	210
144	630	1.70	300	220	150
168	540	2.31	220	160	110

## P16F - BEAM LOADING (METRIC)

Span mm	Max Allowable Uniform Load kN	Defl. at Uniform Load mm	Uniform Loading at Deflection		
			Span/180 kN	Span/240 kN	Span/360 kN
600	7.2	1	7.2	7.2	7.2
750	5.8	2	5.8	5.8	5.4
1,000	4.3	4	4.3	4.3	3.0
1,250	3.5	6	3.5	2.9	1.9
1,500	2.9	9	2.7	2.0	1.4
1,750	2.5	12	2.0	1.5	1.0
2,000	2.2	16	1.5	1.1	0.8
2,500	1.7	25	1.0	0.7	0.5
3,000	1.5	36	0.7	0.5	0.3
3,500	1.2	49	0.5	0.4	0.2
4,000	1.1	64	0.4	0.3	0.2

## P21H - BEAM LOADING (METRIC)

Span mm	Max Allowable Uniform Load kN	Defl. at Uniform Load mm	Uniform Loading at Deflection		
			Span/180 kN	Span/240 kN	Span/360 kN
600	17.1	1	17.1	17.1	17.1
750	13.7	2	13.7	13.7	13.7
1,000	10.3	3	10.3	10.3	8.8
1,250	8.2	5	8.2	8.2	5.7
1,500	6.9	7	6.9	5.9	3.9
1,750	5.9	10	5.8	4.3	2.9
2,000	5.1	13	4.4	3.3	2.2
2,500	4.1	20	2.8	2.1	1.4
3,000	3.4	29	2.0	1.5	1.0
3,500	2.9	40	1.4	1.1	0.7
4,000	2.6	52	1.1	0.8	0.5

Notes:

- Above loads include the weight of the member. This weight must be deducted to arrive at the net allowable load the beam will support.
- Long span beams should be supported in such a manner as to prevent rotation and twist.
- Allowable uniformly distributed loads are listed for various simple spans, that is, a beam on two supports. If load is concentrated at the center of the span, multiply load from the table by 0.5 and corresponding deflection by 0.8.

## P16F - ELEMENTS OF SECTION

Parameter	P16F		P16F (metric)	
Area of Section	0.416	In <sup>2</sup>	2.68	cm <sup>2</sup>
Axis 1-1				
Moment of Inertia (I)	0.168	In <sup>4</sup>	7.0	cm <sup>4</sup>
Section Modulus (S)	0.192	In <sup>3</sup>	3.1	cm <sup>3</sup>
Radius of Gyration (r)	0.650	In	1.7	cm
Axis 2-2				
Moment of Inertia (I)	0.210	In <sup>4</sup>	8.7	cm <sup>4</sup>
Section Modulus (S)	0.240	In <sup>3</sup>	3.9	cm <sup>3</sup>
Radius of Gyration (r)	0.725	In	1.8	cm

## P21H - ELEMENTS OF SECTION

Parameter	P21H		P21H (metric)	
Area of Section	0.749	In <sup>2</sup>	4.83	cm <sup>2</sup>
Axis 1-1				
Moment of Inertia (I)	0.490	In <sup>4</sup>	20.4	cm <sup>4</sup>
Section Modulus (S)	0.455	In <sup>3</sup>	7.5	cm <sup>3</sup>
Radius of Gyration (r)	0.820	In	2.1	cm
Axis 2-2				
Moment of Inertia (I)	0.590	In <sup>4</sup>	24.6	cm <sup>4</sup>
Section Modulus (S)	0.540	In <sup>3</sup>	8.8	cm <sup>3</sup>
Radius of Gyration (r)	0.900	In	2.3	cm



1 1/8" Channel

Telestrut

Nuts & Hardware

General Fittings

Pipe/Conduit Supports

Electrical Fittings

Concrete Inserts

Solar

Unipier®

**P2820, P2940**  
**CHANNEL/TUBE CONNECTORS**

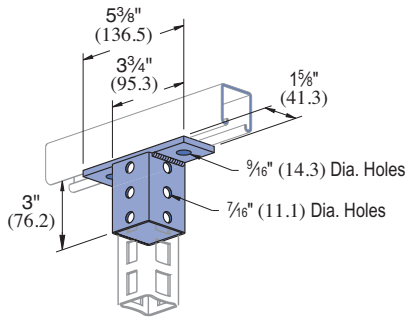

Part No.	Use W/100 pcs	W/100 pcs Lbs (kg)
P2820	P16F	116 (2.6)
P2940	P21H	148 (67.1)

**P2822, P2932** **SPLICE FITTINGS**

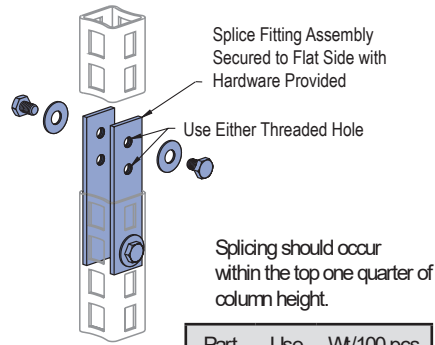

Part No.	Use W/100 pcs	W/100 pcs Lbs (kg)
P2822	P16F	97 (44.0)
P2932	P21H	122 (55.3)

**P2823** **90° RACK FITTING**

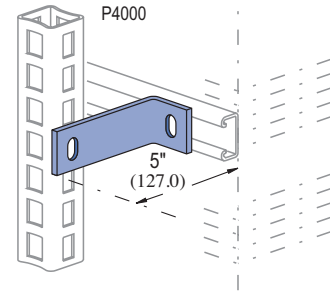

W/100 pcs: 66 Lbs (29.9 kg)

**P2821** **LOCKING CLIP**

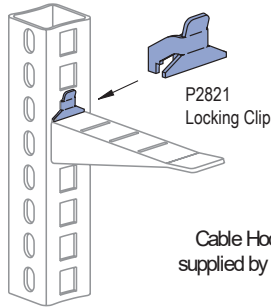

Exclusive Cable Hook Locking Clip prevents Cable Hook removal.

Cable Hook supplied by others.

W/100 pcs: 3 Lbs (1.4 kg)

**P2928, P2929 AND P2930** **CABLE BRACKETS**

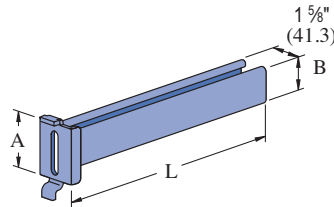

Use with P16F or P21H.

Material: 12 gauge steel.

Part Number	"L" In (mm)	"A" In (mm)	"B" In (mm)	W/100 pcs Lbs (kg)	Uniform Design Load Lbs (kN)
P2928	6 / 152.4	3 1/2 / 88.9	7/8 / 22.2	92 / 41.7	500 / 2.22
P2929	12 / 304.8	3 1/2 / 88.9	1 5/8 / 41.3	320 / 145.1	250 / 1.11
P2930	18 / 457.2	3 1/2 / 88.9	1 5/8 / 41.3	420 / 190.5	170 / 0.76

Safety factor of 3.

**P2920 THRU P2924**

**CABLE BRACKETS**

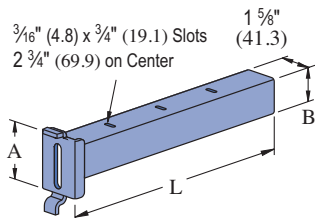

Use with P16F or P21H.

Material: 12 gauge steel.

Part Number	"L" In (mm)	"A" In (mm)	"B" In (mm)	W/100 pcs Lbs (kg)	Uniform Design Load Lbs (kN)
P2920	5 1/2 / 139.7	3 1/2 / 88.9	7/8 / 22.2	90 / 40.8	500 / 2.22
P2921	8 1/4 / 209.6	3 1/2 / 88.9	7/8 / 22.2	120 / 54.4	325 / 1.45
P2922	11 / 279.4	3 1/2 / 88.9	1 5/8 / 41.3	300 / 136.1	275 / 1.22
P2923	13 3/4 / 349.3	3 1/2 / 88.9	1 5/8 / 41.3	340 / 154.2	220 / 0.98
P2924	19 1/4 / 489.0	3 1/2 / 88.9	1 5/8 / 41.3	430 / 195.0	160 / 0.71

Safety factor of 3.



## U.L. LISTED

Unistrut channel is listed by Underwriters' Laboratories as a surface metal raceway. Snap-in closure strip is used to complete the raceway. Accessory parts listed by Underwriters are noted on drawings. The following tables represent maximum number of conductors when raceway is not employed with fixtures or where the clearance between fixtures and raceway is greater than 1/2" (12.7). In all cases the snap-in cover is required to complete raceway enclosure.

### P3300

Gauge	Number and Conductor Size (AWG)				
	14	12	10	8	6
THWN, THHN	40	30	19	9	6
XHHW	26	21	16	7	5
T, TW	26	20	15	7	4
THW	17	14	11	6	4
RH	15	12	7	4	3
RHH, RHW	10	9	7	4	2

### P1000, & -KO, P1100 & -KO

Gauge	Number and Conductor Size (AWG)				
	14	12	10	8	6
THWN, THHN	88	66	42	20	14
XHHW	58	46	35	16	12
T, TW	57	44	34	16	9
THW	37	30	24	12	9
RH	33	27	16	9	6
RHH, RHW	23	20	16	9	6

Channel Part Number	Channel Size and Inside Area			
	Size	Area	40% Area	25% Area
P3300 & KO	1 1/8" x 7/8"	0.975	0.390	0.244
		629	252	157
P3000 & KO	1 1/8" x 1 1/8"	1.677	0.671	0.419
		1,082	433	270
P1000 & KO, P1100 & KO	1 1/2" x 1 1/8"	2.028	0.811	0.507
		1,308	523	327
P5500 & KO	1 5/8" x 2 1/16"	3.169	1.268	0.792
		2,045	818	511
P5000 & KO	1 5/8" x 3 1/4"	4.308	1.723	1.077
		2,779	1,112	695

## C.S.A. APPROVED

Suitable for number of wires in Column A when installed to support and supply electric discharge type lighting fixtures when raceway wiring is suitable for at least 75° C except wire suitable for 60° C may be used when clearance between fixtures and raceways is at least 1/2" (12.7). Also suitable for number of wires in column B when

### P3000, & -KO

Gauge	Number and Conductor Size (AWG)				
	14	12	10	8	6
THWN, THHN	72	54	34	17	12
XHHW	48	37	29	13	10
T, TW	46	36	28	13	7
THW	30	25	20	10	7
RH	27	22	13	7	5
RHH, RHW	19	16	13	7	5

### P5500, & -KO

Gauge	Number and Conductor Size (AWG)				
	14	12	10	8	6
THWN, THHN	141	105	66	33	23
XHHW	93	73	57	27	19
T, TW	91	58	55	26	15
THW	59	49	39	20	15
RH	53	44	26	14	10
RHH, RHW	37	32	26	14	10

### P5000, & -KO

Gauge	Number and Conductor Size (AWG)				
	14	12	10	8	6
THWN, THHN	193	105	91	45	32
XHHW	128	101	78	37	27
T, TW	125	98	75	35	20
THW	81	67	54	28	20
RH	73	60	36	19	13
RHH, RHW	51	44	36	19	13

Note:

Raceways with external joiners shall use a 40% wire fill calculation to determine the number of conductors permitted.

Raceways with internal joiners shall use a 25% wire fill calculation to determine the number of conductors permitted

Also UL Listed

P1001, P1101, P3001, P3301, P5001 & P5501

installed to support electric discharge type lighting fixtures when raceway wiring is suitable for at least 75° C and clearance between fixtures and raceway is at least 1/2" (3.2).

Maximum number of wires for types T, THN, THW, THWN, TV, R, RH, RHH, RHW or XHHW

Raceway Wire Size AWG	P1000, & -KO P1100, & -KO		P3000, & -KO		P3300		P5000 & -KO		P5500, & -KO	
	A	B	A	B	A	B	A	B	A	B
	14	6	10	5	10	4	6	10	10	10
12	6	10	4	10	3	6	10	10	10	10
10	5	8	4	6	-	-	8	10	8	10
8	4	6	3	4	-	-	6	9	6	8
6	2	3	2	2	-	-	4	6	4	6

Unistrut channels are also certified by Canadian Standards Association.



1 1/8" Channel  
Telestrut  
Nuts & Hardware  
General Fittings  
Pipe/Conduit Supports  
Electrical Fittings  
Concrete Inserts  
Solar  
Unipier®

**FLUORESCENT FIXTURES - SUPPORT APPLICATIONS**

**Spring-Nut attachment system**

Conduit connects through knockout in fixture. Fixture is supported by P1006-1420 spring nut and 1/4" round head machine screw. Assembly is supported by P2855 hinged hanger.

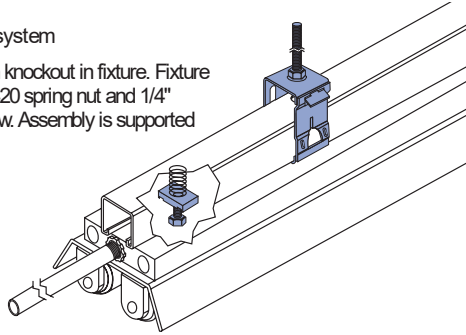

**Slotted channel attachment system**

Conduit connects through knockout in fixture. Fixture is supported by HCSS series hex bolt and hex nut. Raceway is supported by P2855 hanger. To splice a continuous run, use P3922.

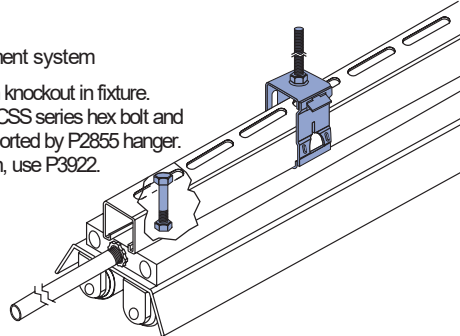

**RECOMMENDED SUPPORT SPACING FOR FIXTURES**

Deflections are based on continuity of span and use of 4 ft. fixtures weighing approximately 30 lbs. each. Do not use joiner fittings between supporting hangers. When using knock-out or slotted channels deflections will be increased approximately 5%. With fixtures spaced 2' - 0" apart, deflection is 60-70% of table. When spaced 4' - 0" apart, deflection is 50-60% of table.

Deflection Table

Channel	Distance Between Supports - In (mm)								
	8' (2.4m)	10' (3m)	12' (3.7m)	14' (4.3m)	16' (4.9m)	18' (5.5m)	20' (6.1m)	22' (6.7m)	24' (7.3m)
P3300	0.187 4.7	-	-	-	-	-	-	-	-
P3000	0.100 2.5	0.250 6.4	0.500 12.7	-	-	-	-	-	-
P1100	0.088 2.2	0.250 6.4	0.437 11.1	0.875 22.2	-	-	-	-	-
P1000	-	0.180 4.6	0.312 7.9	0.625 15.9	1.000 25.4	1.625 41.3	-	-	-
P5500	-	-	-	0.250 6.4	0.500 12.7	0.812 20.6	1.620 41.1	-	-
P5000	-	-	-	-	0.310 7.9	0.625 15.9	1.000 25.4	1.800 45.7	2.500 63.5
P1001	-	-	-	-	0.310 7.9	0.625 15.9	1.000 25.4	1.800 45.7	2.500 63.5
P5001	-	-	-	-	-	0.200 5.1	0.250 6.4	0.400 10.2	0.500 12.7

**HIGH-BAY FIXTURE RACEWAY APPLICATIONS**

**H.I.D. Knockout mounted system**

Fixture attached to and wired from raceway by 1/2" nipple assembly of desired length at channel knockout. P1280W end cap, P3184 closure strip, P2535 conduit connector, and P2855 channel hanger complete assembly. For splicing channels into continuous raceway runs, use joiner fitting P3922.

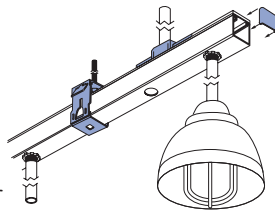

**High-Bay dual mounted system**

Fixtures are connected to and wired from raceway by conduit connector fitting P2536. Raceway is supported by P2855 hanger. P1280W end caps and P3184 closure strip complete the assembly. Conduit connected to raceway through channel knockout.

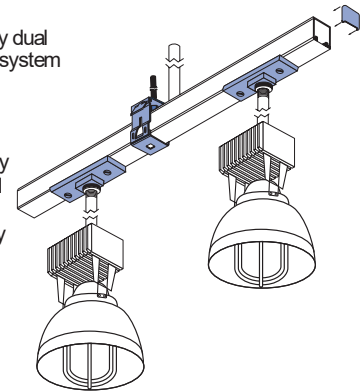

**H.I.D. Plug-in system (with swivel)**

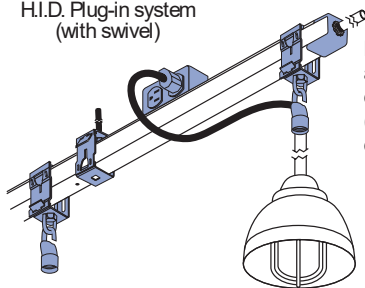

P2855 hangers support raceway and P251-75 end connector joins conduit raceway. P1280W end caps (not shown) and P3184 closure strip complete assembly.

**H.I.D. Plug-in system (rigid mount)**

Raceway is supported and wired by top mounted P2535 conduit connectors. P1280W end caps and P3184 closure strip complete assembly.

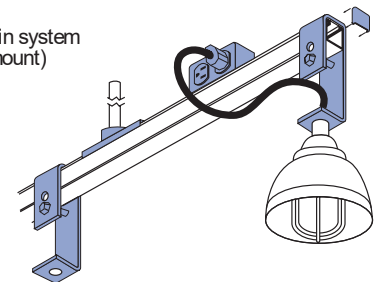

**Uplighting with underhung or remote ballast**

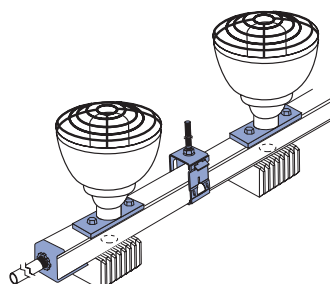

Fixtures attached to and wired from P2535 conduit fittings mounted to slot side of channel. Raceway can be wired by P2521 as shown or, conduit can enter through available knockout. Ballasts in P2521 are connected at the knockout by fixture adapter. In remote ballast installations, follow manufacturers instructions. P2855 hinged hangers support both types of installations. P3184 closure strip and P1280W end caps complete assembly. For continuous raceways, use joiner fitting P3922. P2521-75 end connector joins conduit to raceway.

# CONCRETE INSERTS

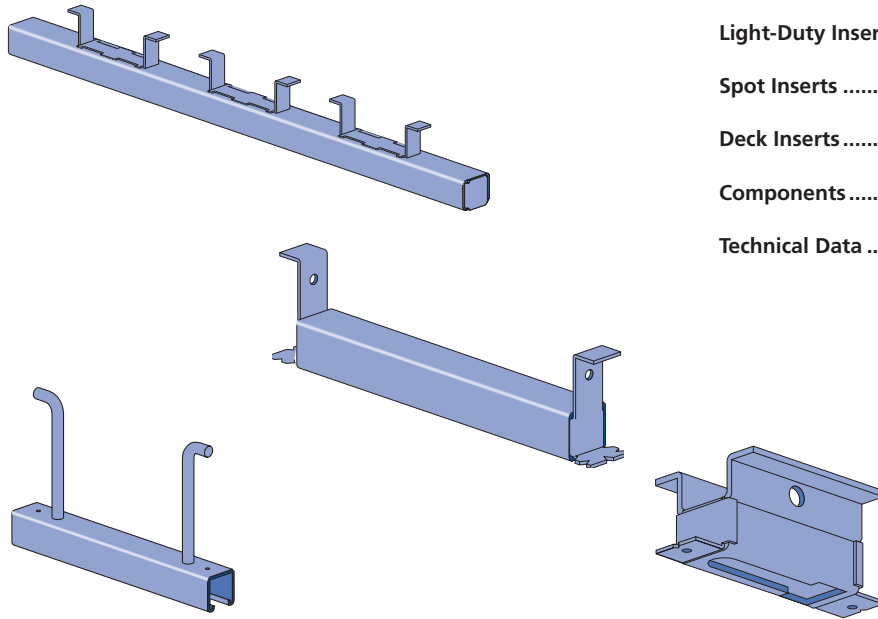

Heavy-Duty Inserts .....	141
Standard-Duty Inserts.....	142, 144
Light-Duty Inserts .....	143
Spot Inserts .....	144
Deck Inserts .....	145
Components .....	145
Technical Data .....	146

## MATERIAL

Cold-formed inserts are manufactured from standard 12 gauge (2.7 mm) Unistrut channel sections conforming to ASTM A1011 SS GR 33 or ASTM A653 GR 33, unless otherwise noted.

To inhibit concrete seepage, all inserts (except spot inserts) are provided with closure strips and end caps or foam filler, unless otherwise requested.

Most concrete inserts are available in stainless steel on special order. Consult factory for ordering information.

## APPLICATION

A wide range of heavy-duty to light-duty "continuous" and "spot" concrete inserts are available for use in pre-cast, pre-stressed or poured-in-place concrete floors, walls or ceilings.

## FINISHES

Cold-formed, standard-duty, light-duty and spot concrete inserts are available in:

Hot dipped galvanized (HG), conforming to ASTM A123 or A153;

Pre-galvanized (PG), conforming to ASTM A653 GR 33

Plain (PL)

## DESIGN LOAD

Design loads, where shown, are based on 3,000 PSI concrete, unless noted.

## STANDARD LENGTHS

Insert lengths range from 3 inches (76.2 mm) to 20 feet (6.10m) with a tolerance of  $\pm 1/4$ -inch (6.4mm).

## DIMENSIONS

Imperial dimensions are illustrated in inches. Metric dimensions are shown in parentheses or as noted. Unless noted, all metric dimensions are in millimeters and rounded to one decimal place.

Custom-designed inserts are available on special order. Consult factory for ordering information.



1 1/8" Channel

Telestrut

Nuts & Hardware

General Fittings

Pipe/Conduit Supports

Electrical Fittings

Concrete Inserts

Solar

Unipier®

**Heavy Duty Light Duty**

**Standard Duty**

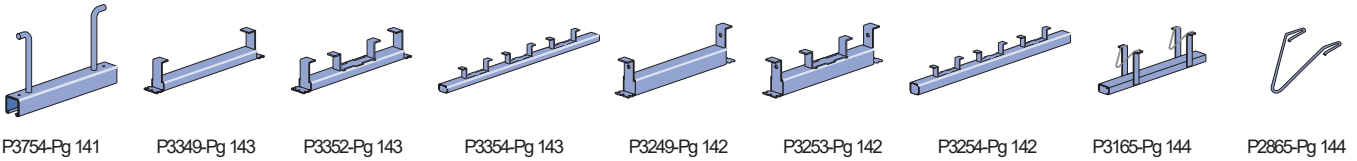

**Spot Inserts and Components**

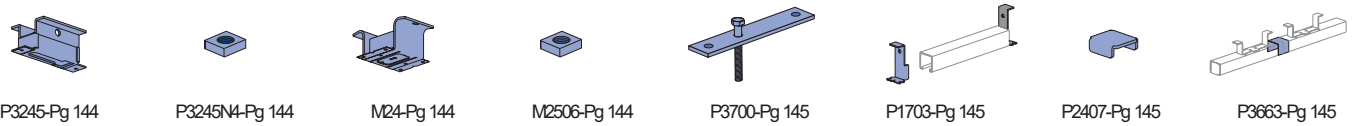

**Fiberglass Concrete Inserts**

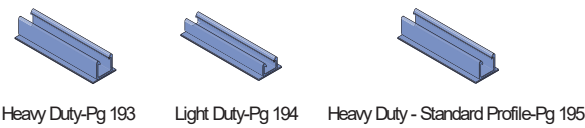

**Closure Strips**

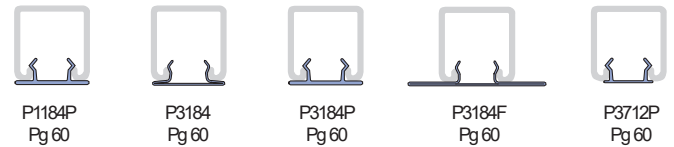

**Channel Nuts**

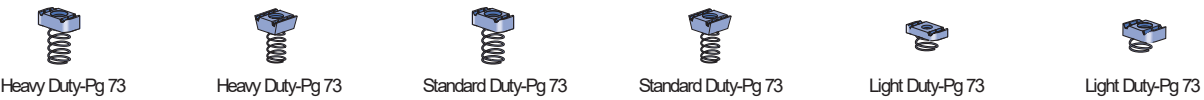

**INSTALLING CONCRETE INSERTS**

1. Nail insert to concrete form using prepunched nail holes
2. Attach rebars to flanges on insert

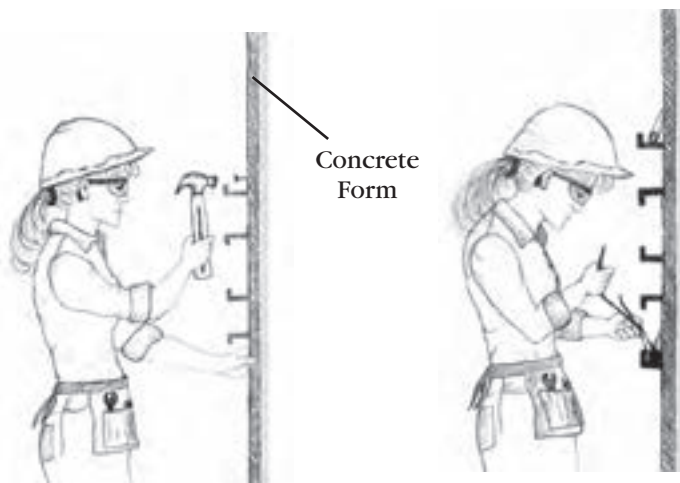

**USING INSTALLED CONCRETE INSERT**

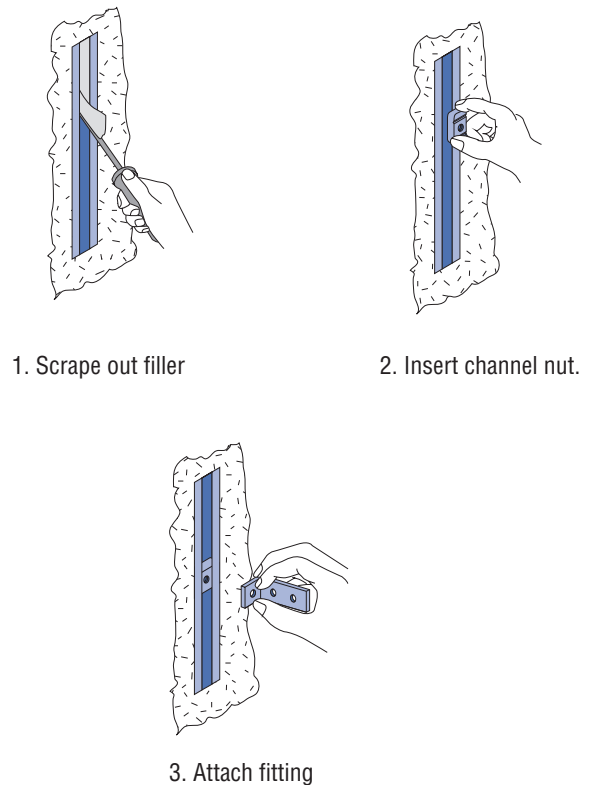

The Unistrut concrete insert is firmly fixed to the concrete side of the form before pouring. When the forms are removed, the insert is ready for use. Brackets and other components can be attached at any point of the continuous entry channel.

**Installation and Heavy Duty Inserts**

**P3246**

- Up to 5,700 lbs. tension capacity in 3,000 psi concrete
- Sizes available to accept threaded rod from 3/4" to 1-1/2"
- Fiberglass rods to interface with the rebar or reinforcing rods, reducing the potential for a galvanic interaction
- 316 Stainless steel body with fiberglass rods to prevent corrosion
- Meets several industry and federal specifications, including: A-A-1192A (Type 18), VVH-171-E (Type 18), ANSI/MSS SP-69 and MSS SP-58 (Type 18)

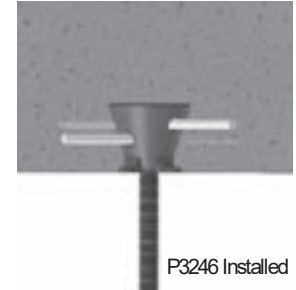

Part Number	Threaded Hole Size <sup>a</sup>	Maximum Allowable Load (lbs.)		
		Vertical	Shear <sup>b</sup>	45° Pull
P3246-75 ST	3/4" - 10	3,230 <sup>a</sup>	1,930	2,740
P3246-87 ST	7/8" - 9	4,480 <sup>a</sup>	2,680	3,800
P3246-1 ST	1" - 8	5,700	3,540	5,000
P3246-125 ST	1 1/4" - 7	5,700	5,700	6,000
P3246-150 ST	1 1/2" - 6	5,700	8,280	6,000

Safety Factor of 5 in 3,000 psi concrete  
<sup>a</sup> Limited by Threaded Rod Safe Load in accordance with MSS-SP-58  
<sup>b</sup> Limited by MSS-SP-58 Tension Safe Load multiplied by 0.6

**P3754**

**1 5/8" x 1 5/8" CHANNEL**

- Closure strip P3712 P and a styrene bead end cap that fits inside the channel to inhibit concrete seepage are included.
- The recommended design load when used for curtain wall anchorage is 5,000 pounds and is based on use in average, good concrete. The design load includes 1/3 increase in load as permitted by AISI Specifications and Uniform Building Code when stresses are produced by wind or earthquake and other loads.
- The recommended design load is based on using two P1010 nuts at no less than 3" O.C. and no closer than 2" to either end of the insert. The distance between the insert centerline and the concrete edge must be a minimum of 3".
- All nuts and fittings for P3200 series concrete inserts will fit.
- Material: Cold formed from 12 Ga. (2.7mm) steel conforming to ASTM A1011 SS GR 33 or ASTM A653 GR 33 A.
- Finish: Choice of hot-dipped galvanized (HG) conforming to ASTM A123 or A153, or pre-galvanized (PG) conforming to ASTM A653-G90.

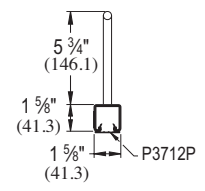
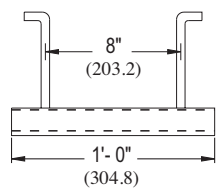
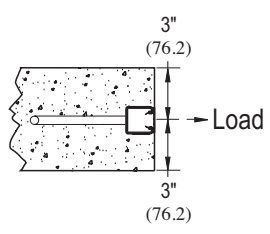
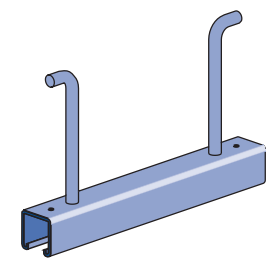

Part Number	Insert Length ± 1/4" (6.4mm) In (mm)	Wt/100 pcs Lbs (kg)	Max. Anchor Spacing In (mm)	Max. Allowable Point Load Lbs (kN)	Spacing of Point Loads In (mm)	Max. Allowable Uniform Load Lbs (kN)
P3754	12 304.8	210 95.3	8 203.2	2,500 11.12	3 76.2	5,000 22.24

Safety factor 3

1 5/8" Channel  
 Telestrut  
 Nuts & Hardware  
 General Fittings  
 Pipe/Conduit Supports  
 Electrical Fittings  
 Concrete Inserts  
 Solar  
 Unipier®



**P3200 SERIES**

**1 1/8" x 1 3/8" CHANNEL** **PG HG**

P3249 thru P3252

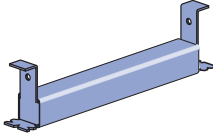

"NC" Suffix – No Closure Strip, With End Caps  
"WC" Suffix – With Closure Strip & End Caps

P3253

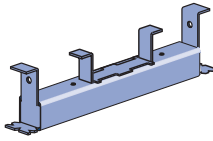

"NC" Suffix – No Closure Strip, With End Caps & Back Plates  
"WC" Suffix – With Closure Strip, End Caps & Back Plates

P3254 thru P3270

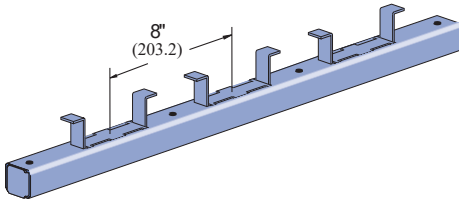

"NC" Suffix – No Closure Strip, W/End Caps & Back Plates  
"WC" Suffix – W/Closure Strip, End Caps & Back Plates  
"X" – No Closure Strip, No End Caps, W/Back Plates

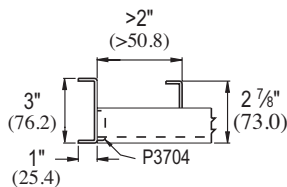
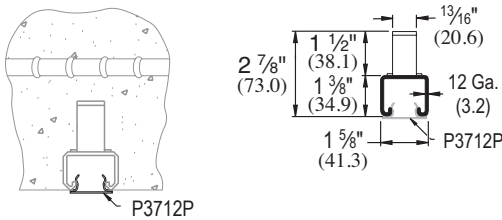

- Includes closure and end caps unless otherwise requested.
- P3280 end cap used when distance to first anchor is up to 2" (51 mm).
- P3704 end cap is used when end distance to first anchor is over 2" (51 mm).
- Nail or anchor inserts to forms every 16" (406.4 mm) to 24" (609.6 mm).
- Anchors are 8" (203.2 mm) on center.
- Material: Cold formed from 12 Ga. (3) steel conforming to ASTM A1011 SS GR 33 or ASTM A653 GR 33. A. Stainless steel available on special order.
- Finish: Choice of hot-dipped galvanized (HG) conforming to ASTM A123 or A153, or pre-galvanized (PG) conforming to ASTM A653-G90.

Part Number	Insert Length In/Ft (mm)	Wt/100 pcs Lbs (kg)	Max. Allowable Point Load Lbs (kN)	Min. Spacing of Pt. Loads In (mm)	Max. Allowable Uniform Load Lbs (kN)
P3249	3" 76.2	85 39	500 2.22	—	500 2.22
P3250	4" 101.6	100 45	800 3.56	—	800 3.56
P3251	6" 152.4	130 59	1,000 4.45	—	1,000 4.45
P3252	8" 203.2	159 72	1,200 5.34	—	1,200 5.34
P3253	12" 304.8	227 103	2,000 8.90	—	2,000 8.90
P3254	16" 406.4	270 122	2,000 8.90	12 304.8	4,000 17.79
P3255	20" 508.0	357 162	2,000 8.90	12 304.8	4,000 17.79
P3256	24" 609.6	399 181	2,000 8.90	12 304.8	4,000 17.79
P3257	32" 812.8	527 239	2,000 8.90	12 304.8	2,000 2,976.3 (kg/m)
P3257A	36" 914.4	616 279	2,000 8.90	12 304.8	2,000 2,976.3 (kg/m)
P3258	40" 1,016.0	661 300	2,000 8.90	12 304.8	2,000 2,976.3 (kg/m)
P3259	4' 1,219.2	786 357	2,000 8.90	12 304.8	2,000 2,976.3 (kg/m)
P3260	5' 1,524.0	1,003 455	2,000 8.90	12 304.8	2,000 2,976.3 (kg/m)
P3261	6' 1,828.8	1,173 532	2,000 8.90	12 304.8	2,000 2,976.3 (kg/m)
P3262	7' 2,133.6	1,390 630	2,000 8.90	12 304.8	2,000 2,976.3 (kg/m)
P3263	8' 2,438.4	1,560 708	2,000 8.90	12 304.8	2,000 2,976.3 (kg/m)
P3264	9' 2,743.2	1,741 790	2,000 8.90	12 304.8	2,000 2,976.3 (kg/m)
P3265	10' 3,048.0	1,947 883	2,000 8.90	12 304.8	2,000 2,976.3 (kg/m)
P3266	12' 3,657.6	2,334 1,059	2,000 8.90	12 304.8	2,000 2,976.3 (kg/m)
P3267	14' 4,267.2	2,717 1,232	2,000 8.90	12 304.8	2,000 2,976.3 (kg/m)
P3268	16' 4,876.8	3,116 1,413	2,000 8.90	12 304.8	2,000 2,976.3 (kg/m)
P3269	18' 5,486.4	3,530 1,601	2,000 8.90	12 304.8	2,000 2,976.3 (kg/m)
P3270	20' 6,096.0	3,882 1,761	2,000 8.90	12 304.8	2,000 2,976.3 (kg/m)

Safety factor 3.

1 1/8" Channel

Telestrut

Nuts & Hardware

General Fittings

Pipe/Conduit Supports

Electrical Fittings

Concrete Inserts

Solar

Unipier®

**Light Duty**

**P3300 SERIES**

**1 5/8" x 7/8" CHANNEL** **PG HG**

P3349 thru P3351

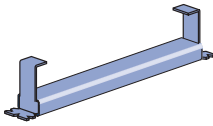

"NC" Suffix – No Closure Strip, With End Caps  
"WC" Suffix – With Closure Strip & End Caps

P3352 thru P3353

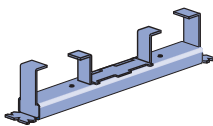

"NC" Suffix – No Closure Strip, With End Caps & Back Plates  
"WC" Suffix – With Closure Strip, End Caps & Back Plates

P3354 thru P3370

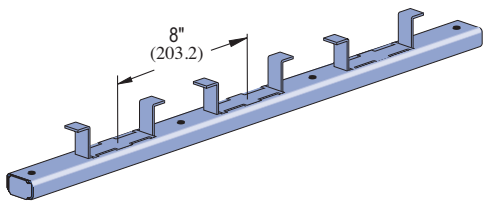

"NC" Suffix – No Closure Strip, W/End Caps & Back Plates  
"WC" Suffix – W/Closure Strip, End Caps & Back Plates  
"X" – No Closure Strip, No End Caps, W/Back Plates

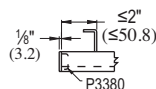
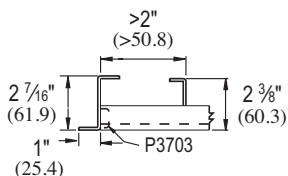
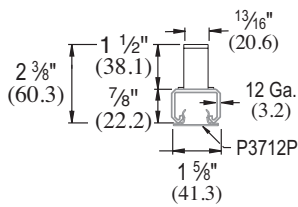
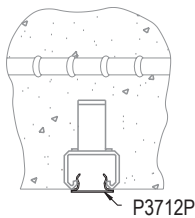

- Includes closure and end caps unless otherwise requested.
- P3380 end cap used when distance to first anchor is up to 2" (51 mm).
- P3703 end cap is used when end distance to first anchor is over 2" (51 mm).
- Nail or anchor inserts to forms every 16" (406.4 mm) to 24" (609.6 mm).
- Anchors are 8" (203.2 mm) on center.
- Material: Cold formed from 12 Ga. (3 mm) steel conforming to ASTM A1011 SS GR. 33 or A653 GR 33. A. Stainless steel available on special order.
- Finish: Choice of hot-dipped galvanized (HG) conforming to ASTM A123 or A153, or pre-galvanized (PG) conforming to ASTM A653-G90.

Part Number	Insert Length In/Ft. (mm)	Wt/100 pcs Lbs (kg)	Max. Allowable Point Load Lbs (kN)	Min. Spacing of Pt. Loads In (mm)	Max. Allowable Uniform Load Lbs (kN)
P3349	3" 76.2	68 31	400 1.78	—	400 1.78
P3350	4" 101.6	81 37	500 2.22	—	500 2.22
P3351	6" 152.4	102 46	750 3.34	—	750 3.34
P3352	8" 203.2	122 55	1,000 4.45	—	1,000 4.45
P3353	12" 304.8	174 79	1,500 6.67	—	1,500 6.67
P3354	16" 406.4	185.0 84	1,500 6.67	12 304.8	3,000 13.34
P3355	20" 508.0	231 105	1,500 6.67	12 304.8	3,000 13.34
P3356	24" 609.6	277 126	1,500 6.67	12 304.8	3,000 13.34
P3357	32" 812.8	370 168	1,500 6.67	12 304.8	1,500 Lbs./Ft. 2,232.2 (kg/m)
P3357A	36" 914.4	416 189	1,500 6.67	12 304.8	1,500 Lbs./Ft. 2,232.2 (kg/m)
P3358	40" 1,016.0	463 210	1,500 6.67	12 304.8	1,500 Lbs./Ft. 2,232.2 (kg/m)
P3359	4' 1,219.2	555 252	1,500 6.67	12 304.8	1,500 Lbs./Ft. 2,232.2 (kg/m)
P3360	5' 1,524.0	694 315	1,500 6.67	12 304.8	1,500 Lbs./Ft. 2,232.2 (kg/m)
P3361	6' 1,828.8	832 377	1,500 6.67	12 304.8	1,500 Lbs./Ft. 2,232.2 (kg/m)
P3362	7' 2,133.6	971 440	1,500 6.67	12 304.8	1,500 Lbs./Ft. 2,232.2 (kg/m)
P3363	8' 2,438.4	1,110 503	1,500 6.67	12 304.8	1,500 Lbs./Ft. 2,232.2 (kg/m)
P3364	9' 2,743.2	1,249 567	1,500 6.67	12 304.8	1,500 Lbs./Ft. 2,232.2 (kg/m)
P3365	10' 3,048.0	1,387 629	1,500 6.67	12 304.8	1,500 Lbs./Ft. 2,232.2 (kg/m)
P3366	12' 3,657.6	1,665.0 755	1,500 6.67	12 304.8	1,500 Lbs./Ft. 2,232.2 (kg/m)
P3367	14' 4,267.2	1,942 881	1,500 6.67	12 304.8	1,500 Lbs./Ft. 2,232.2 (kg/m)
P3368	16' 4,876.8	2,220 1,007	1,500 6.67	12 304.8	1,500 Lbs./Ft. 2,232.2 (kg/m)
P3369	18' 5,486.4	2,497 1,133	1,500 6.67	12 304.8	1,500 Lbs./Ft. 2,232.2 (kg/m)
P3370	20' 6,096.0	2,775 1,259	1,500 6.67	12 304.8	1,500 Lbs./Ft. 2,232.2 (kg/m)

Safety factor 3.



**P3165 SERIES**

**1 5/8" x 7/8" CHANNEL**

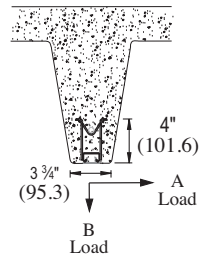
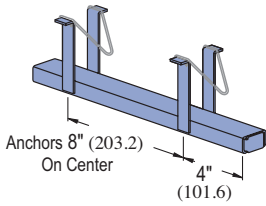

"X" Suffix – No Closure Strip, No End Caps  
"WC" Suffix – With Closure Strip & End Caps

Part No.	Length Ft (M)	Wt/100 pcs Lbs (kg)
P3165	10	1,650
	3.05	748.4
P3170	20	3,280
	6.10	1,487.8

Maximum allowable load/ft.

Concrete	A Lbs (kN)	B Lbs (kN)
Light Wt	425	800
	1.89	3.56
Normal Wt	500	1,000
	2.22	4.45

Safety factor 3.

Safety factor 3.

- Designed for use in prestressed concrete.
- Anchors 8" (203.2 mm) on center; first anchor 4" (101.6 mm) from end.
- Includes closure and end caps unless otherwise requested.
- Material: Cold formed from 12 Ga. (2.7 mm) steel conforming to ASTM A1011 SS GR 33 or ASTM A653 GR 33. A. Stainless steel available on special order.
- Finish: Choice of pre-galvanized (PG) conforming to ASTM A653-G90, or plain (PL).

**P3245**

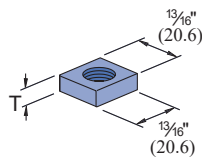
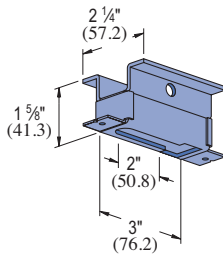

Square Nut for P3245 Insert

Part Number	Wt/100 pcs Lbs (kg)	Max. Allowable Pt. Load Lbs (kN)
P3245	54	1,000
	24.5	4.45

Part Number	Size/Thread In	T In (mm)	Wt/100 pcs Lbs (kg)
P3245-N4	1/4" — 20	5/16"	6
		7.9	2.7
P3245-N6	3/8" — 16	5/16"	5
		7.9	2.3
HSCQN050	1/2" — 13	7/16"	6
		11.1	2.7

Finish: Pre-galvanized

Safety factor of 3

- For 1/4", 3/8", or 1/2" size attachment or hanger rod.
- Insert nuts to be ordered separately.

**P2865-10, -15, -20**

**HOLD-DOWN SPRINGS**

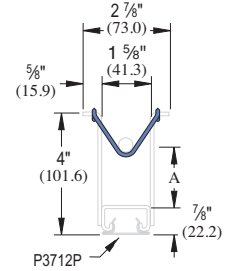
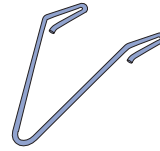

Finish: Plain

Part Number	A In (mm)	Wt/100 pcs Lbs (kg)
P2865-10	1	2
	25.4	0.9
P2865-15	1 1/2	2
	38.1	0.9
P2865-20	2	2
	50.8	0.9

**M24**

**SPOT INSERT**

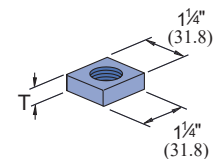
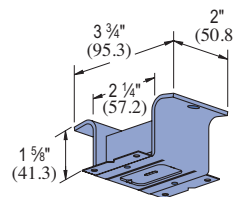

Square Nut for M24

Part Number	Wt/100 pcs Lbs (kg)	Max. Allowable Pt. Load Lbs (kN)
M24	52	800
	23.6	3.56

Part Number	Size/Thread In	T In (mm)	Wt/100 pcs Lbs (kg)
M2506	1/4" — 20	1/4"	13
		6.4	5.9
M2508	3/8" — 16	3/8"	14
		9.5	6.4
M2510	1/2" — 13	1/2"	14
		12.7	6.4
M2512	5/8" — 11	1/2"	12
		12.7	5.4
M2523	3/4" — 10	1/2"	11
		12.7	5.0
M2524	7/8" — 9	1/2"	10
		12.7	4.5

Finish: Electro-galvanized

Safety factor of 5

- Ribs along sides of slot give extra strength to case.
- Insert nuts M2506 thru M2524 to be ordered separately.



**Deck Inserts**

**P3700 SERIES**

**DECK INSERT**

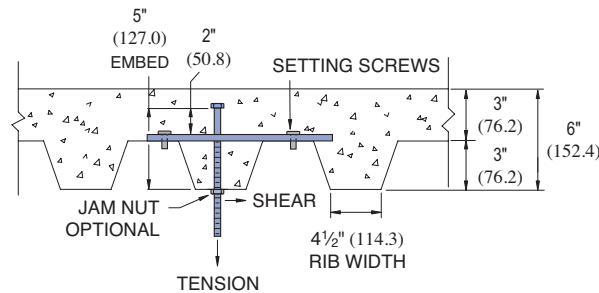
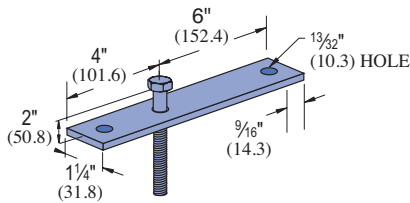

Part Number	Rod Dia. In	Tension Load Lbs (kN)	Shear Load Lbs (kN)	Wt/100 pcs Lbs (kg)
P3700-37	3/8	850 3.78	600 2.67	89 40.4
P3700-50	1/2	1,380 6.14	1000 4.45	111 50.3
P3700-62	5/8	1920 8.54	1760 7.83	141 64.0

Notes:

1. Allowable loads have been determined by the manufacturer's testing, analysis, and technical specification.
2. Values are based on a safety factor of 5.
3. 20 Gauge Metal Deck

**P1703, P1704, P3703, P3704, P4703**

**END CAP ANCHORS**

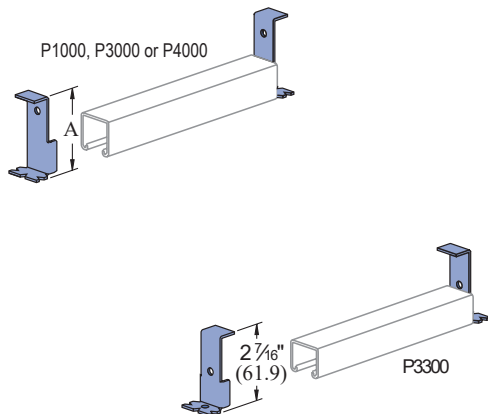

Part Number	Channel	"A" In (mm)	Wt/100 pcs Lbs (kg)
P1703	P1000	2 13/32	30
		61.1	13.6
P1704	P1000	3 7/32	37
P3703	P3300	2 1/16	17
		61.9	7.7
P3704	P3000	3	20
		76.2	9.1
P4703	P4000	2 3/8	27
		60.3	12.2

Note: End cap anchor for use with 1 1/2" wide standard Unistrut inserts only.

**P2407, P3280, P3380**

**END CAPS**



Part Number	Fits Channel	Wt/100 pcs Lbs (kg)
P2407	P1000	10 4.5
P3280	P3000	8 3.6
P3380	P3300	5 2.3

**P3663, P4663**

**JOINT COVERS**

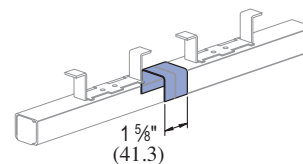

Part Number	Use With Insert Series	Wt/100 pcs Lbs (kg)
P3663	P3270	10 4.5
		6 2.7
P4663	P3370	6 2.7

NOTE: Joint cover for use with 1 1/2" wide standard Unistrut inserts only.

1 1/2" Channel

Telestrut

Nuts & Hardware

General Fittings

Pipe/Conduit Supports

Electrical Fittings

Concrete Inserts

Solar

Unipier®



1 1/8" Channel

Telestrut

Nuts & Hardware

General Fittings

Pipe/Conduit Supports

Electrical Fittings

Concrete Inserts

Solar

Unipier®

**LOAD CHART BY LENGTH**

Part Number	Insert Length In (mm)	Wt/100 ft Lbs (kg)	Anchor Spacing In (mm)	Max. Allowable Point Load Lbs (kN)	Min. Spacing Between Pt. Loads In (mm)	Max. Allowable Uniform Load Lbs (kN)
P3249	3	85	3	500		500
		38.6	76.2	2.22	-	2.22
P3349	76.2	68	3	400		400
		30.8	76.2	1.78	-	1.78
P3250	4	100	4	800		800
		45.4	101.6	3.56	-	3.56
P3350	101.6	81	4	500		500
		36.7	101.6	2.22	-	2.22
P3251	6	130	6	1,000		1,000
		59.0	152.4	4.45	-	4.45
P3351	152.4	102	6	750		750
		46.3	152.4	3.34	-	3.34
P3252	8	159	8	1,200		1,200
		72.1	203.2	5.34	-	5.34
P3352	203.2	122	8	1,000		1,000
		55.3	203.2	4.45	-	4.45
P3754	12	210	8	2,500	3	5,000
		95.3	203.2	11.12	76.2	22.24
P3253	304.8	227	4	2,000		2,000
		103.0	101.6	8.90	-	8.90
P3353	304.8	174	4	1,500		1,500
		78.9	101.6	6.67	-	6.67
P3254	16	270	4	2,000	12	4,000
		122.5	101.6	8.90	304.8	17.79
P3354	406.4	185	4	1,500	12	3,000
		83.9	101.6	6.67	304.8	13.34
P3255	20	357	4	2,000	12	4,000
		161.9	101.6	8.90	304.8	17.79
P3355	508.0	231	4	1,500	12	3,000
		104.8	101.6	6.67	304.8	13.34
P3256	24	399	4	2,000	12	4,000
		181.0	101.6	8.90	304.8	17.79
P3356	609.6	277	4	1,500	12	3,000
		125.6	101.6	6.67	304.8	13.34

**SPOT INSERT LOAD CHART**

Part Number	Wt/100 pcs Lbs (kg)	Anchor Spacing In (mm)	Max. Allowable Point Load Lbs (kN)
P3246	414	-	5,700
	187.8	-	25.35
M26/M2812	54	-	1,500
	24.5	-	6.67
M3245	52	-	1,000
	23.6	-	4.45
M24/M2512	52	-	800
	23.6	-	3.56

**MAXIMUM ALLOWABLE POINT LOAD**

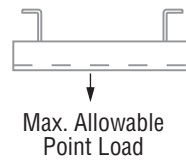

The maximum allowable point load may be placed anywhere along the insert. All loads placed less than 2" from the end of an insert must be reduced by 50%.

**MAXIMUM ALLOWABLE UNIFORM LOAD**

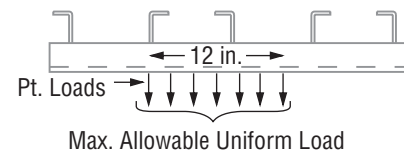

The maximum allowable uniform load must be placed as a series of point loads.

**SPACING OF MULTIPLE POINT LOADS**

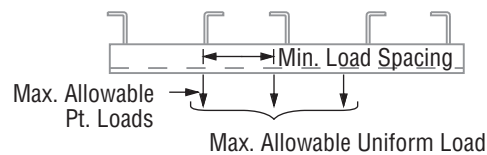

**CONTINUOUS CONCRETE INSERT LOAD CHART**

UP TO 20 FT. (6.10M)

Part Number	Wt/100 ft Lbs (kg)	Anchor Spacing In (mm)	Max. Allowable Point Load Lbs (kN)	Min. Spacing Between Pt. Loads In (mm)	Max. Allowable Uniform Load Lbs/Ft (kg/m)
P3270	194	4	2,000	12	2,000
	88.0	101.6	8.90	304.8	2,976.3
P3370	139	4	1,500	12	1,500
	63.0	101.6	6.67	304.8	2,232.2
P3170*	165	8	1,000	12	1,000
	74.8	203.2	4.45	304.8	1,488.2

\*When used in prestressed concrete "T" Beam.  
Load data is based on use of 3000 PSI concrete.

**PULL-OUT LOAD**

Minimum Edge Distance to Achieve Rated Pull-Out Capacity

1 7/8" (47.6mm); P3170  
A = 3" (76.2mm); all others

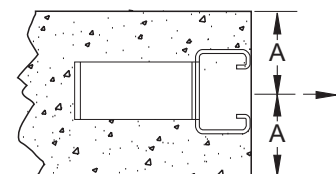
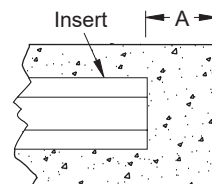

# SOLAR COMPONENTS

Unistrut® represents a line of steel, aluminum, and fiberglass strut and accessories used extensively in electrical infrastructure support.

Application Example.....	148
Solar Connectors.....	149
Key Advantages.....	150

Unistrut is available in a range of corrosion inhibiting finishes making it a prime choice in today's marketplace. The Unistrut system is infinitely adjustable for a multitude of configurations and uses.

The solar components shown in this section allow you to shape an effective solution for mounting solar panels that fits your exact needs.

## MATERIAL

Unistrut channels are accurately and carefully cold formed to size from low-carbon strip steel.

### STEEL: PLAIN

12 Ga. (2.7 mm), 14 Ga.(1.9 mm) and  
16 Ga. (1.5 mm) ASTM A1011 SS GR 33.

### STEEL: PRE-GALVANIZED

12 Ga. (2.7 mm), 14 Ga. (1.9 mm) and  
16 Ga. (1.5mm) ASTM A653 GR 33.

## FINISHES

Fittings are available in:

- Green Powder Coat (GR), conforming to commercial standards for Powder Coating,
- Electro-galvanized (EG), conforming to ASTM B633 Type III SC1;
- Hot-dipped Galvanized (HG), conforming to ASTM A123 or A153
- Plain (PL).

## DIMENSIONS

Imperial dimensions are illustrated in inches. Metric dimensions are shown in parenthesis or as noted. Unless noted, all metric dimensions are in millimeters and rounded to one decimal place.

## DESIGN BOLT TORQUE

BOLT SIZE	¼"-20	⅜"-18	½"-16	⅝"-13	¾"-11	⅞"-10
Rec.Torque Ft/Lbs (Nm)	6 (8)	11 (15)	19 (26)	50 (68)	100 (136)	125 (170)
Max Torque Ft/Lbs (Nm)	7 (9)	15 (20)	25 (34)	70 (95)	125 (170)	135 (183)

## LISTINGS

UL File No. - E361025	PV Mounting Systems
-----------------------	---------------------



**TYPICAL SOLAR INSTALLATION**

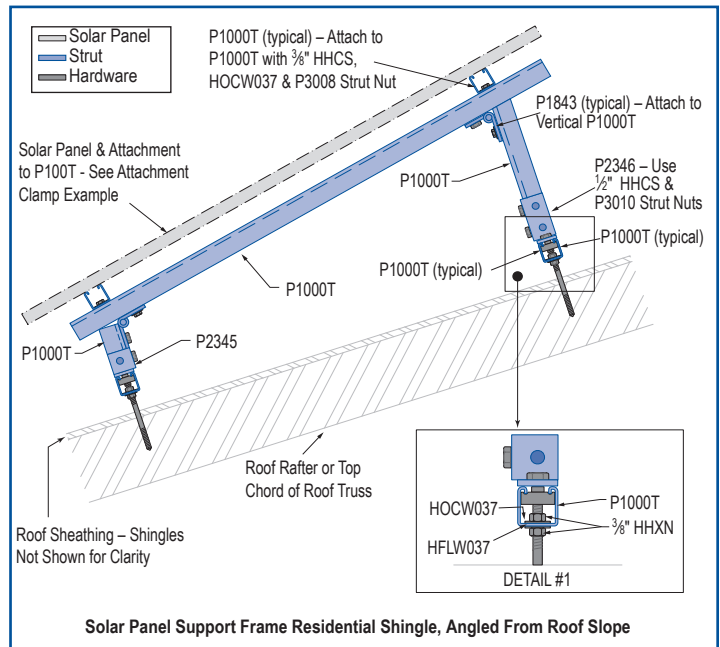
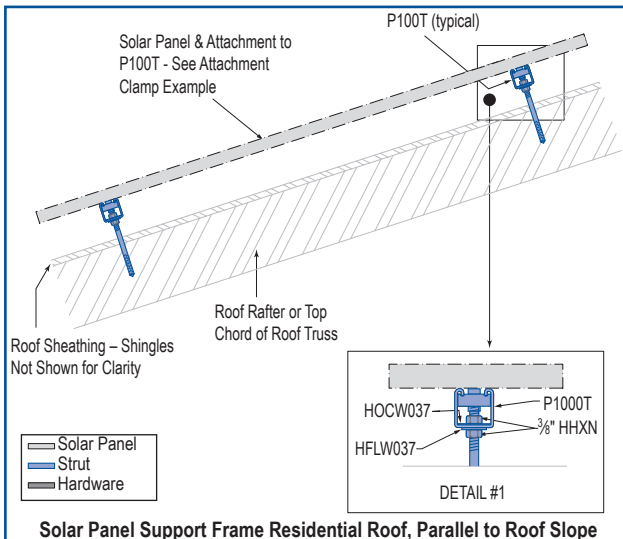
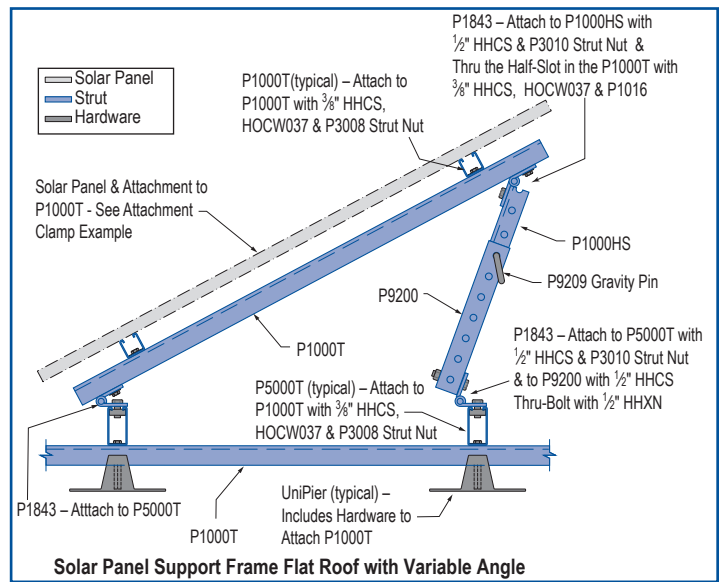
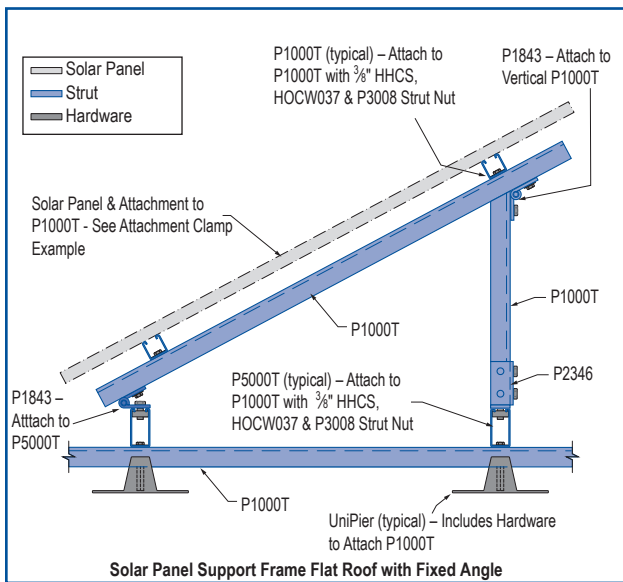
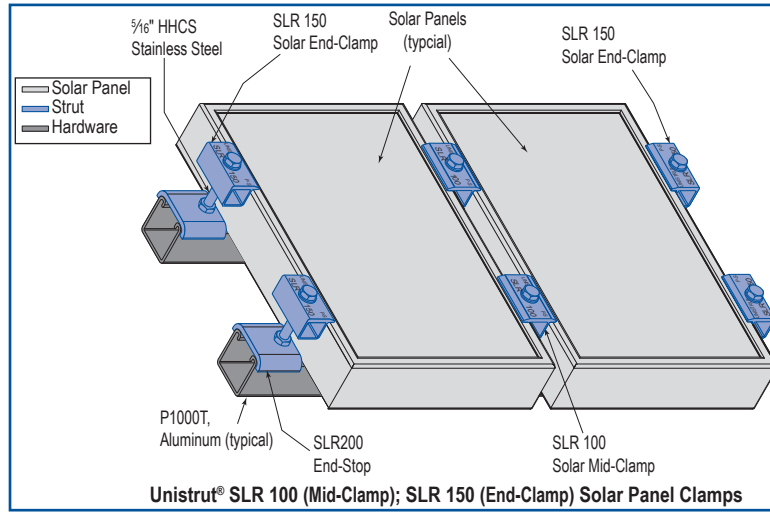

SLR200 – SOLAR END CLAMP

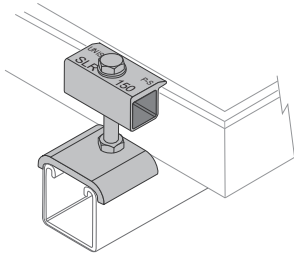

- 5/16" x 2 3/4" hex head cap screw, stainless steel nut; lock washer included
- End-clamp design for use with strut based racking system
- Patent-pending end-stop feature allows use with vertical strut
- Meets uplift loads of 350 lbs.
- \*Patent-pending

SLR100 – SOLAR MID-CLAMP

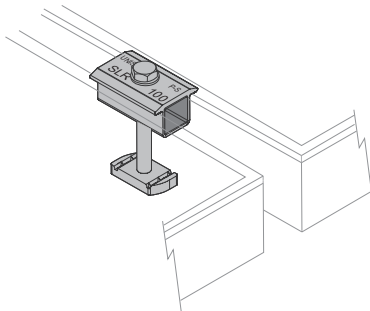

- 5/16" x 2 3/4" hex head cap screw, stainless steel nut; lock washer included
- Mid-clamp design for use with strut based racking system
- Provides .8"(21 mm) panel spacing
- Meets spacing requirements of WEEB-WMC
- Meets uplift loads of 350 lbs.

WEEB - WMC – ELECTRICAL EQUIPMENT BONDING WASHER

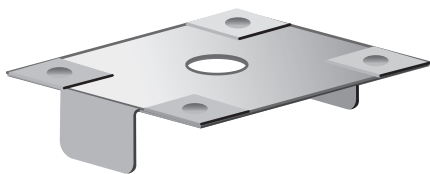

- Patented design features stainless steel teeth that pierce into anodized aluminum, providing a gas tight connection which prevents oxidation
- Meets ANSI/UL467 requirements for bonding/grounding systems
- Quick installation that is safe, reliable and consistent

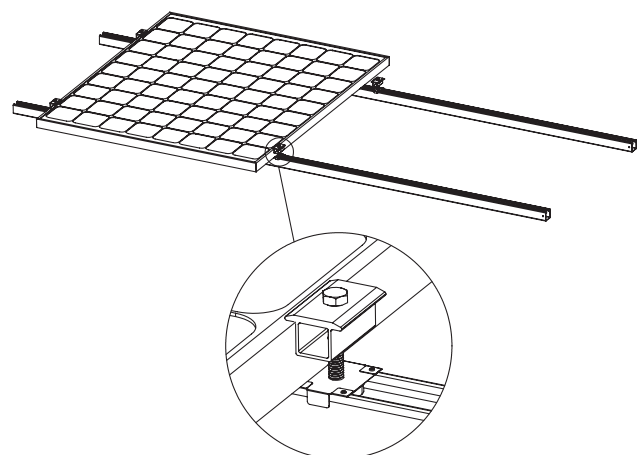



1 1/8" Channel

Telestrut

Nuts & Hardware

General Fittings

Pipe/Conduit Supports

Electrical Fittings

Concrete Inserts

Solar

Unipier®



**KEY ADVANTAGES**

- The market's only specific panel mounting components made exclusively for use with Unistrut.
- Simple design used by the industry for a variety of installation methods and applications.
- Stainless steel hardware included with all solar clamps.
- Available in Black or Silver Anodized (Material AA-6063-T6) for corrosion protection and sleek appearance.
- Best fit with Unistrut channel to create less penetration, and superior slip resistance.
- Available and supported by Unistrut's national network of distributors.

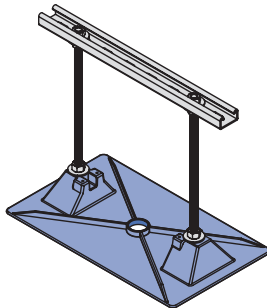
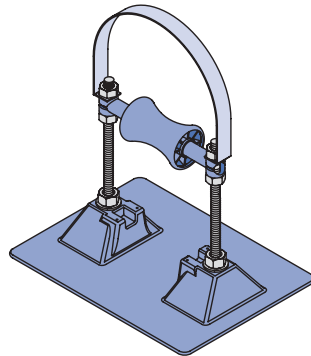
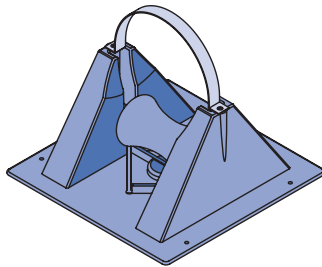
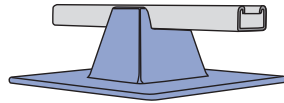
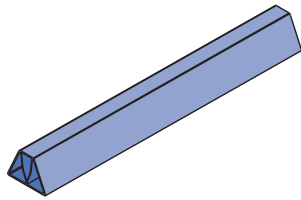

Sleeper Support ..... 153 - 154  
 Strut Support ..... 155 - 156

### Conduit Supports

Mounted Support, Polycarbonate Base ..... 157  
 Elevated Support, Polycarbonate Base ..... 157  
 Elevated Support, Steel Base ..... 158

### Gas and Mechanical Supports

Mounted Support, Polycarbonate Base ..... 158  
 Mounted Support, w/Roller Polycarbonate Base ..... 158  
 Elevated Support, w/Roller, Polycarbonate Base ..... 159  
 Elevated Support, w/Roller, Steel Base ..... 160

### Accessories

Spacer ..... 160  
 Support Pads, Deck Plates ..... 160  
 Pipe Hanger Bases, Polycarbonate and Steel ..... 161

### Fabricated Supports

Single Base Trapeze ..... 162  
 Double Base Trapeze ..... 163  
 Heavy Duty Double Base Trapeze ..... 163  
 Double Base Duct Support ..... 163  
 Mechanical Supports ..... 164  
 Bridge Cross-Over, Walkway, Service Platform or Ramp ..... 164

Installation ..... 165

Pipe Diameters and Loading ..... 166

Technical Data ..... 167 - 168





1 1/8" Channel

Telestrut

Nuts & Hardware

General Fittings

Pipe/Conduit Supports

Electrical Fittings

Concrete Inserts

Solar

Unipier®

**Sleeper Support**

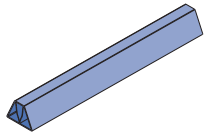

Rooftop Sleeper Support  
Pg 153 - 154

**Strut Support**

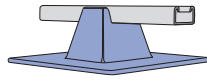

Model UP  
Strut Support  
Pg 155

**Conduit Support**

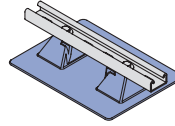

Mounted  
Polycarbonate Base  
Pg 157

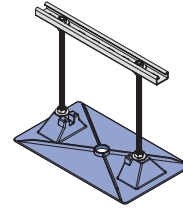

Elevated Support  
Polycarbonate Base  
Pg 157

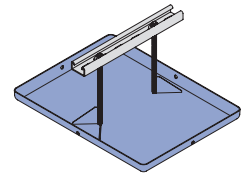

Elevated Support  
Steel Base  
Pg 158

**Gas and Mechanical Support**

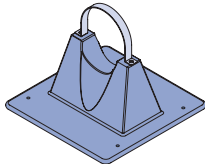

Mounted  
Polycarbonate Base  
Pg 158

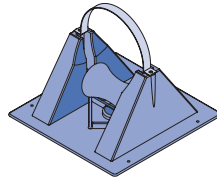

Mounted, w/Roller  
Polycarbonate Base  
Pg 158

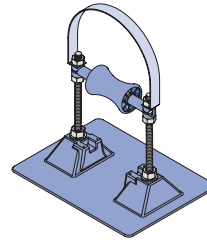

Elevated Support, w/Roller  
Polycarbonate Base  
Pg 159

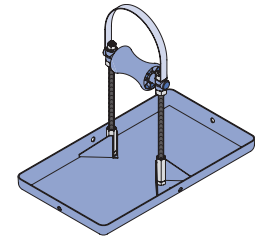

Elevated Support, w/Roller  
Steel Base  
Pg 160

**Accessories**

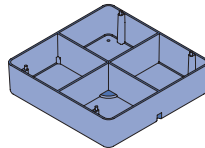

Spacer for Model 1.5, 3-R  
Pg 160

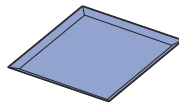

Support Pads &  
Deck Plates  
Pg 160

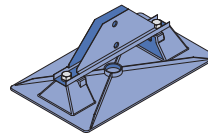

Polycarbonate Bases  
Pg 161

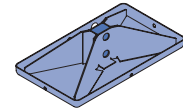

Steel Bases  
Pg 161

**Fabricated Supports**

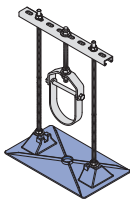

Single Base Trapeze  
Pg 162

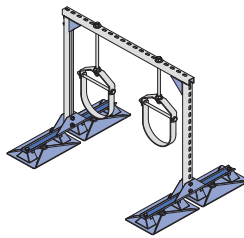

Double Base Trapeze  
Pg 163

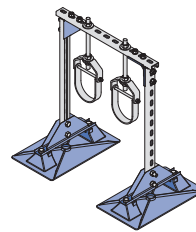

Heavy Duty, Double Base Trapeze  
Pg 163

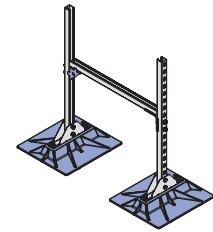

Double Base Duct Support  
Pg 163

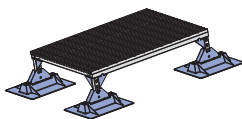

Heavy Duty Mechanical Support  
Pg 164

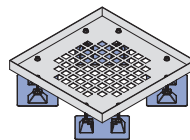

Light Duty Mechanical Support  
Pg 164

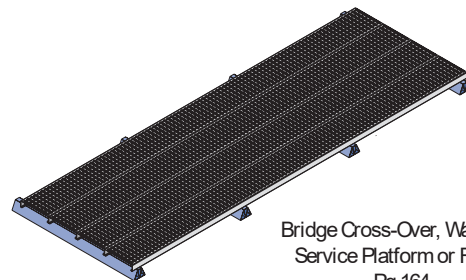

Bridge Cross-Over, Walkway,  
Service Platform or Ramp  
Pg 164



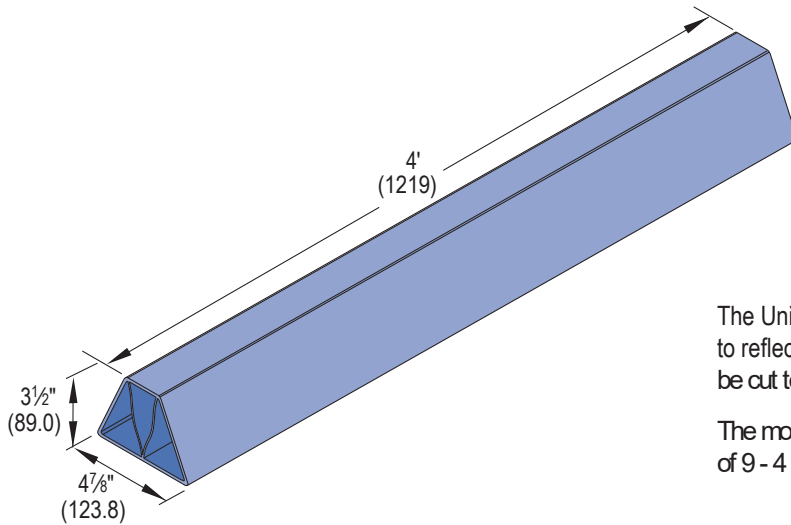

The Unipier rooftop sleeper is the first rooftop support that is white to reflect the sun's UV rays. It is cost-effective, lightweight and can be cut to the desired length while on the job site.

The model RSS4 is conveniently packaged in shrink wrap bundles of 9 - 4 ft. supports that can be easily carried to the rooftop.



The Unipier sleeper support is lightweight, just 4 lbs./4 ft. section, so it is easily transported to the job site in bundles of 9 supports.



The Unipier sleeper support can be conveniently cut to lengths of 6" or longer right on the job site.



TEK screws or other self tapping fasteners are used to attach conduit supports, pipe clamps or other clamping fittings.

NOTE: Load not to exceed 50 lbs./6" length  
Part Number: RSS4



1 1/8" Channel

Telestrut

Nuts & Hardware

General Fittings

Pipe/Conduit Supports

Electrical Fittings

Concrete Inserts

Solar

**Unipier®**

The Sleeper Support is not restricted to just pipe clamps. It makes a perfect companion for the Roofwalk® Rooftop Walkways.

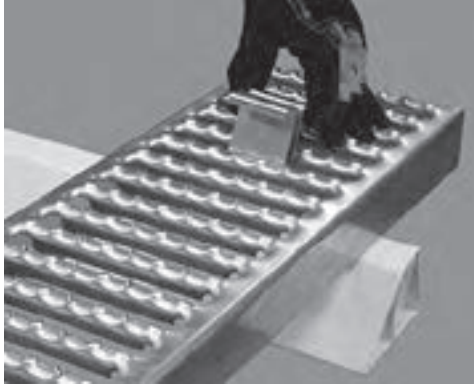

Position the grating on the Unipier sleeper support and insert the appropriate size hold down clip (G639, G607, or G620).

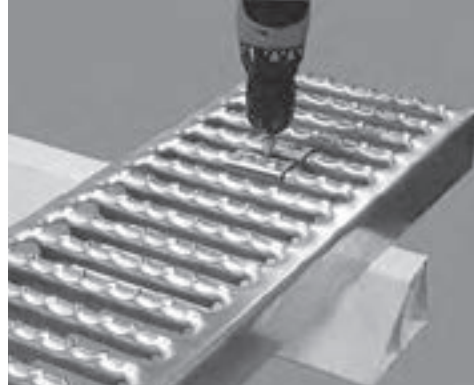

Use a TEK screw to attach the hold down clip.

***That's all that is required!***

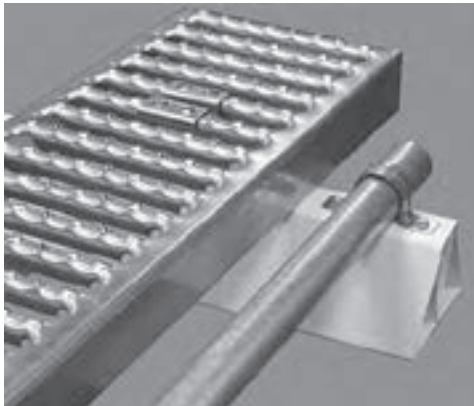

You can even use the Unipier support for multiple tasks. Here we have Unistrut Roofwalks® Rooftop Walkways and a piece of electrical conduit attached to the sleeper.

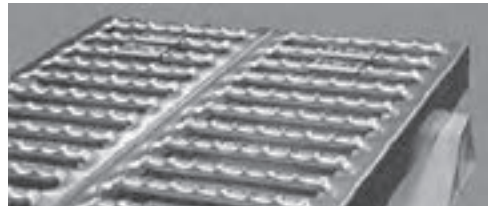

Grating can also be used to construct a platform for heavy equipment or even as a workstand.

### UP-SPSS Style Support

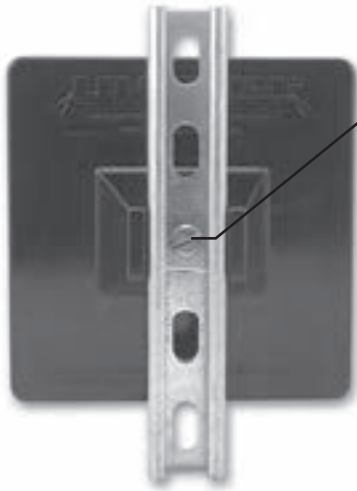

- Align Center hole of P4100T on base.
- Place square washer inside P4100T.
- Insert screw & torque to 19 ft./lbs.

Part Number	Qty. Unipier Bases	Supporting Channel	
		Qty.	Description
UP-BK	4	0	Base Only
UP-SPSS-6 HG	4	4	6" - P4100T HG (up to 3½" Pipe)
UP-SPSS-10HG	4	4	10" - P4100T HG (4" to 8" Pipe)

**NOTE:**

1. The maximum uniform load on P1000T is 400 lbs.
2. Uniform load is limited by roof base allowed load of 200 lbs. (5 psi on roof).

**Single Pier Installation**

1. Align center hole of Unistrut P4100T on base and attach using supplied hardware. Torque screw to 19 ft./lbs.
2. Place pipe/tubing on P4100T and attach pipe/tubing clamp.

### UP-MPDS Style Support

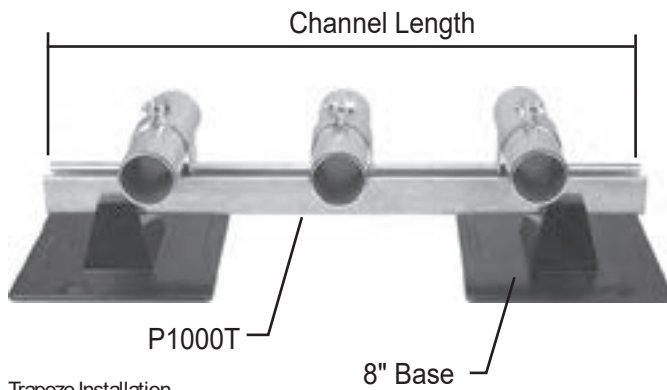

**Trapeze Installation**

1. Align end holes of Unistrut P1000T on bases and attach using supplied hardware. Torque screw to 19 ft./lbs.
2. Place pipe/tubing on support and attach with appropriate pipe/tubing clamp.

Part Number	Qty. Unipier Bases	Supporting Channel	
		Qty.	Description
UP-MPDS-26HG	4	2	26" - P1000T HG for Trapeze
UP-MPDS-38HG	4	2	38" - P1000T HG for Trapeze
UP-MPDS-50HG	4	2	50" - P1000T HG for Trapeze
UP-MPDS-62HG	4	2	62" - P1000T HG for Trapeze

**NOTE:**

1. The maximum uniform load on P1000T is 400 lbs.
2. Uniform load is limited by roof base allowed load of 200 lbs. (5 psi on roof).

**NOTE:** Kits do not include pipe/tubing or clamps.



**Support Spacing**

Pipe Size (Nom.)	Support Spacing			
	Sch. 40 Pipe Water-Filled <sup>(a)</sup>		Conduit GRC <sup>(b)</sup>	
	Single Pier	Trapeze <sup>(d)</sup>	Single Pier	Trapeze <sup>(d)</sup>
3/8"	7'	7'	N/A	N/A
1/2"	7'	7'	10'	10'
3/4"	7'	7'	10'	10'
1"	7'	7'	12'	12'
1 1/4"	7'	7'	14'	14'
1 1/2"	9'	9'	14'	14'
2"	10'	10'	16'	16'

Pipe Size (Nom.)	Support Spacing			
	Sch. 40 Pipe Water-Filled <sup>(a)</sup>		Conduit GRC <sup>(b)</sup>	
	Single Pier	Trapeze <sup>(d)</sup>	Single Pier	Trapeze <sup>(d)</sup>
2 1/2"	11'	11'	16'	16'
3"	12'	12'	13 <sup>(c)</sup>	20'
3 1/2"	13'	13'	11 <sup>(c)</sup>	20'
4"	12 <sup>(c)</sup>	14'	9 <sup>(c)</sup>	20'
5"	8 <sup>(c)</sup>	16'	6 <sup>(c)</sup>	20'
6"	6 <sup>(c)</sup>	17'	4 <sup>(c)</sup>	20'
8"	4 <sup>(c)</sup>	19'	N/A	N/A

Note:  
 (a) Based on ANSI/MSS SP-69, 2003 Edition, Table 3.  
 (b) Based on 2002 NEC, Table 344.30(B)(2).  
 (c) Spacing limited to roof base allowed load of 200 lbs. (5 psi on roof).  
 (d) Spacing may be limited by maximum allowed weight on trapeze to 400 lbs.

**Application Examples**

Unipier Rooftop Support System provides a simple and versatile way to support and manage pipe, tubing, conduit, HVAC systems, and the like. The Unipier Rooftop Support System does not require roof surface penetration and allows the parts to remain off the surface.

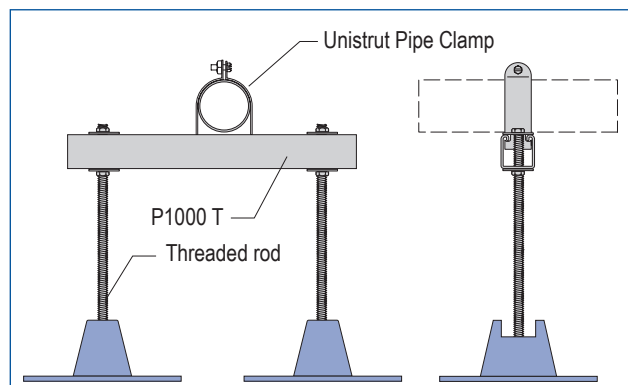
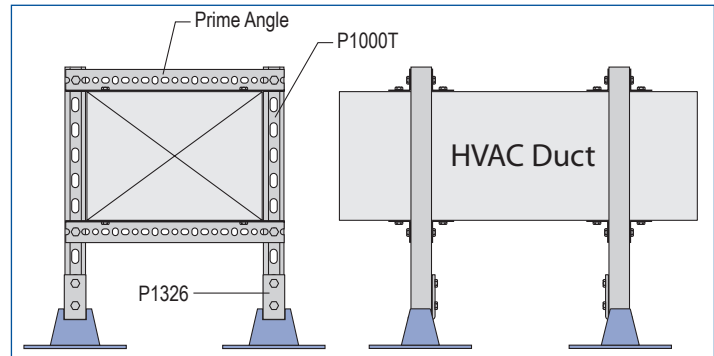
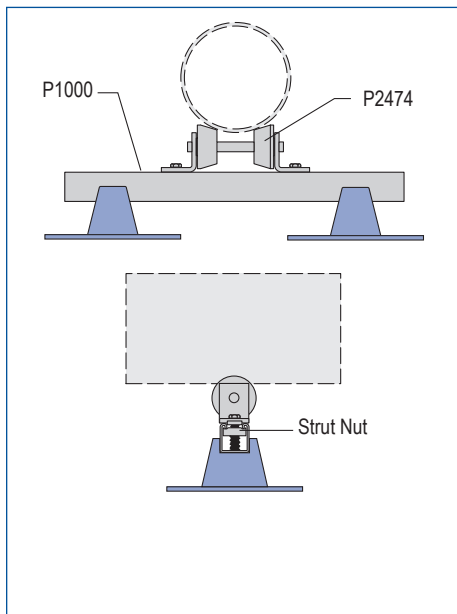

1 1/8" Channel  
 Telestrut  
 Nuts & Hardware  
 General Fittings  
 Pipe/Conduit Supports  
 Electrical Fittings  
 Concrete Inserts  
 Solar  
 Unipier®

### Mounted Support, Polycarbonate Base

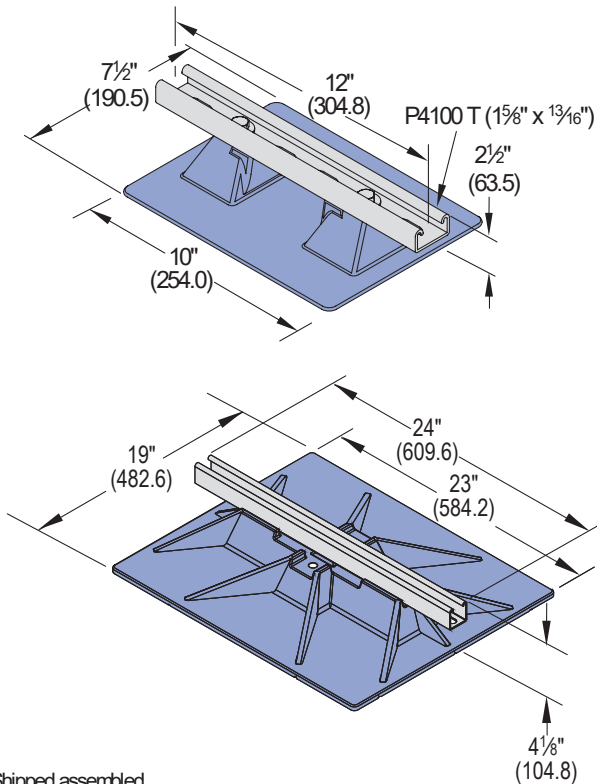

Shipped assembled.

Part Number	Material	Max. Uniform Load	Wt./Each
25-CS-2	Polycarbonate	100 lbs.	2.3 lbs.
24-BS-4	Polycarbonate	640 lbs.	8.0 lbs.

### Determining Maximum Pipe Size

Maximum pipe size supported by any of the strut supports is determined by the load and the clear space required between the pipes. The spacing between pipes should be as follows:

- 1" between piping 3" and smaller.
- 1-1/2" between a pipe 3" and smaller and a pipe 4" or larger.
- 2" between piping 4" and larger.
- At least 1" between pipe clamp and end of strut

For example, a support for two 3" pipes would require:

$$1" + 3" + 1\text{-}1/2" + 3" + 1" = 9\text{-}1/2" \text{ wide channel support}$$

### Elevated Support, Polycarbonate Base

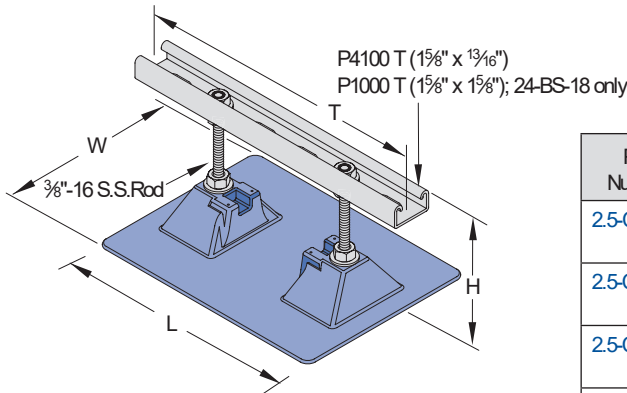

Note: Base for 2.5-CS-5, 2.5-CS-7 shown. Other bases have additional support or flanges to handle the increased loads.

All bases are polycarbonate material

Shipped assembled.

Part Number	"H" (max) in. (mm)	"W" in. (mm)	"L" in. (mm)	"T" in. (mm)	Max. Uniform Load	Wt./Each (lbs.)
2.5-CS-5	5" (127.0)	7 1/2" (190.5)	10" (254.0)	12" (304.8)	100 lbs.	2.1
2.5-CS-7	7 1/2" (190.5)	7 1/2" (190.5)	10" (254.0)	12" (304.8)	100 lbs.	2.5
2.5-CS-12	12" (304.8)	9" (228.6)	15 1/4" (387.4)	12" (304.8)	100 lbs.	4.0
16-BS-7	7" (177.8)	9" (228.6)	15 1/4" (387.4)	16" (406.4)	125 lbs.	5.0
16-BS-12	12" (304.8)	9" (228.6)	15 1/4" (387.4)	16" (406.4)	125 lbs.	8.0
20-BS-7	7" (177.8)	16" (406.4)	18" (457.2)	20" (508.0)	440 lbs.	10.8
20-BS-12	12" (304.8)	16" (406.4)	18" (457.2)	20" (508.0)	440 lbs.	15.1
24-BS-18	12" (304.8)	23" (584.2)	19" (482.6)	24" (609.6)	640 lbs.	8.0



**Elevated Support, Steel Base**

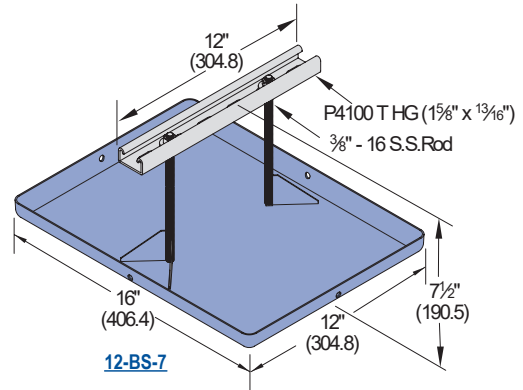
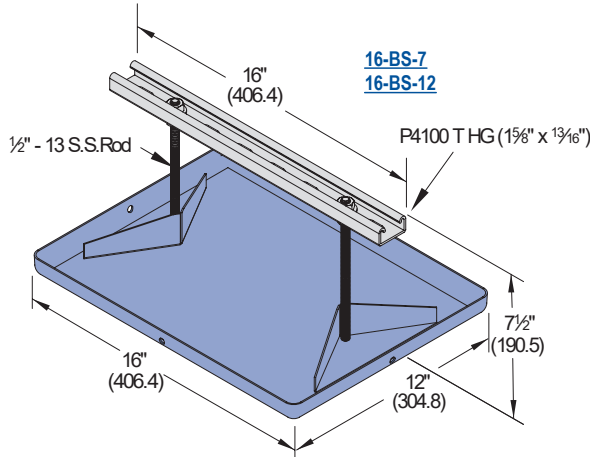

Shipped assembled.

Part Number	Base Material	Max. Uniform Load	Wt./Each
16-BS-7 HG	Hot-Dipped Galvanized	150 lbs.	7.5 lbs.
16-BS-7 SS	Stainless Steel	150 lbs.	7.5 lbs.

Part Number	Base Material	Max. Uniform Load	Wt./Each
12-BS-7 HG	Hot-Dipped Galvanized	150 lbs.	7.5 lbs.
12-BS-7 SS	Stainless Steel	150 lbs.	7.5 lbs.

**Unipier® Rooftop Pipe Support System - Gas & Mechanical Support**

**Mounted, Polycarbonate Base**

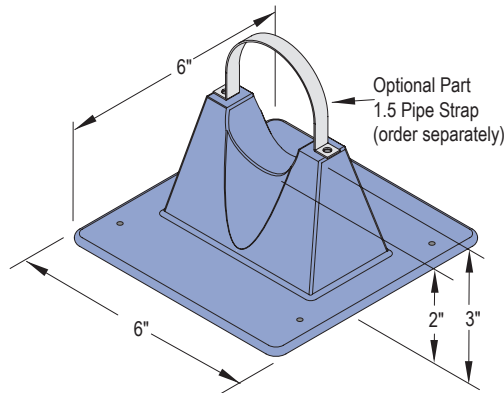

Part Number	Max. Pipe Capacity	Max. Uniform Load	Wt./Ea.	Optional Pipe Strap
1.5 Pipe Support	1 1/2" ID, 1.9" OD	80 lbs.	0.35 lbs.	1.5 Pipe Strap

Note: Base is polycarbonate

Optional pipe strap aluminum w/SS Screws

Shipped assembled.

**Mounted, with Roller, Polycarbonate Base**

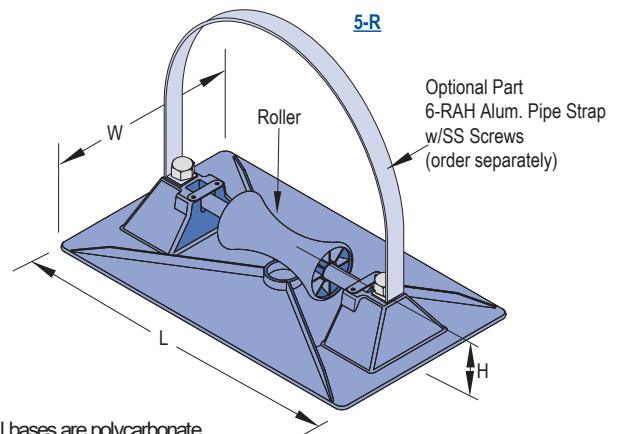
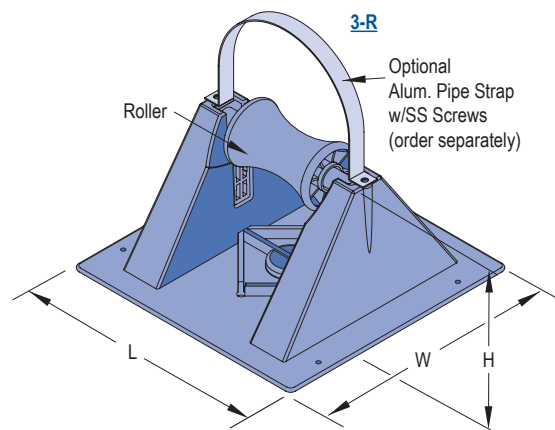

Note: All bases are polycarbonate

Part Number	"H" in. (mm)	"W" in. (mm)	"L" in. (mm)	Roller size	Max. Pipe Capacity	Max. Uniform Load	Wt./Ea. Lbs.	Optional Pipe Strap
3-R-2	2.15" (54.6)	7 3/4" (196.9)	7 3/4" (196.9)	3" (76.2)	3" ID 3 3/4" OD	100 lbs.	1.1 lbs.	3-R-2 Pipe Strap
3-R-4	4" (101.6)	7 3/4" (196.9)	7 3/4" (196.9)	3" (76.2)	3" ID 3 3/4" OD	100 lbs.	1.2 lbs.	3-R-4 Pipe Strap
5-R	2.35" (59.7)	9" (228.6)	15 1/4" (387.4)	5" (127.0)	5" ID 6" OD	150 lbs.	2.4 lbs.	6-RAH Pipe Strap

Elevated Support, with Roller, Polycarbonate Base

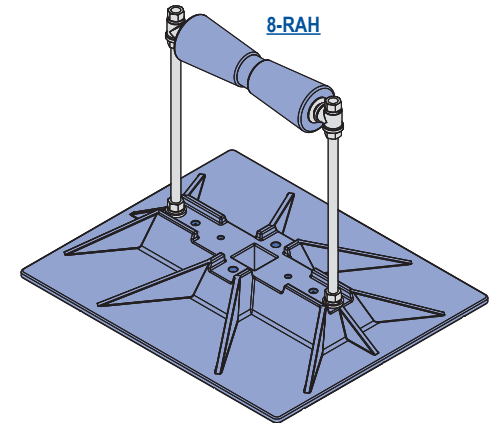
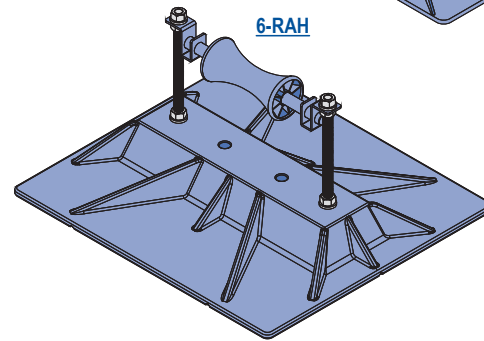
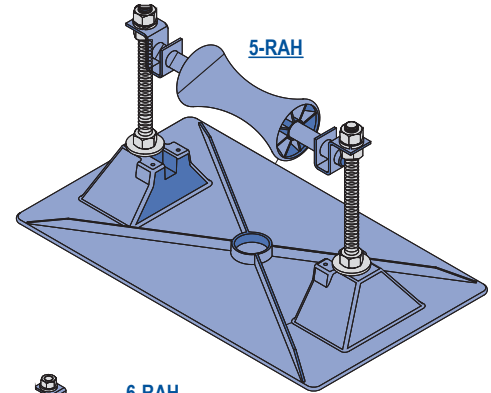
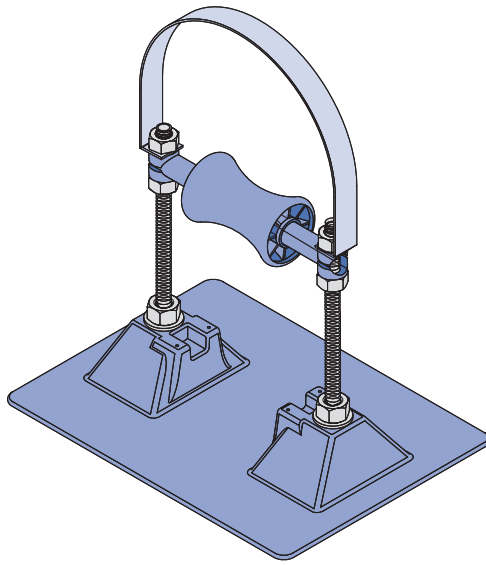

Note: Base for 3-RAH-7 shown. Other bases have additional support or flanges to handle the increased loads.

All bases are polycarbonate material

Optional pipe strap aluminum w/SS Screws

Shipped assembled.

Part Number	"H" (max) in. (mm)	"W" in. (mm)	"L" in. (mm)	Roller Size in. (mm)	Max. Pipe Capacity	Max. Uniform Load	Wt./Ea. Lbs.	Optional Pipe Strap
3-RAH-7	7" (177.8)	7 1/2" (190.5)	10" (254.0)	3" (76.2)	3" ID 3 3/4" OD	100 lbs.	1.9	3-RAH Pipe Strap
3-RAH-12	12" (304.8)	9" (228.6)	15 1/4" (387.4)	3" (76.2)	3" ID 3 3/4" OD	100 lbs.	5.8	3-RAH Pipe Strap
5-RAH-7	7" (177.8)	9" (228.6)	15 1/4" (387.4)	5" (127.0)	5" ID 6" OD	150 lbs.	4.8	6-RAH Pipe Strap
5-RAH-12	12" (304.8)	9" (228.6)	15 1/4" (387.4)	5" (127.0)	5" ID 6" OD	150 lbs.	4.8	6-RAH Pipe Strap
6-RAH-7	7 1/2" (190.5)	16" (406.4)	18" (457.2)	5" (127.0)	6" ID 8 1/2" OD	250 lbs.	8.8	6-RAH Pipe Strap
6-RAH-12	12" (304.8)	16" (406.4)	18" (457.2)	5" (127.0)	6" ID, 8 1/2" OD	250 lbs.	9.8	6-RAH Pipe Strap
8-RAH-18	18" (457.2)	19" (482.6)	23" (584.2)	12" (304.8)	6" ID, 8 1/2" OD	640 lbs.	20.0	8-RAH Pipe Strap



1 1/8" Channel

Telestrut

Nuts & Hardware

General Fittings

Pipe/Conduit Supports

Electrical Fittings

Concrete Inserts

Solar

Unipier®

**Elevated Support, with Roller, Steel Base**

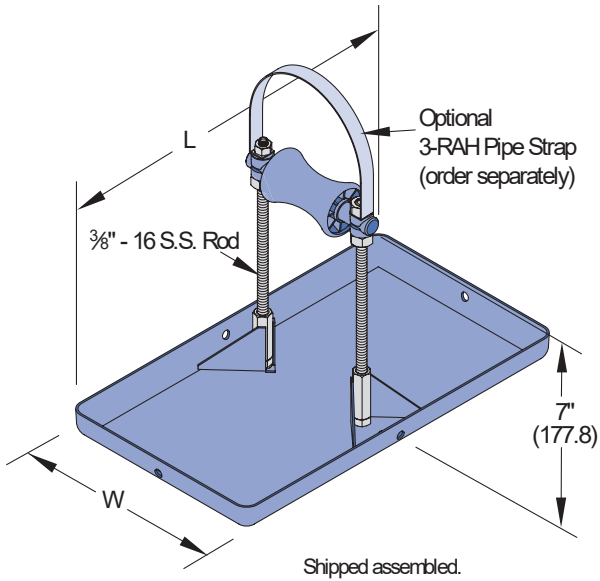

Part Number	"W" in. (mm)	"L" in. (mm)	Roller in. (mm)	Material	Max. Pipe Capacity	Max. Uniform Load	Wt. Each Lbs
3-RAH-7 HG	8" (203.2)	14" (355.6)	3" (76.2)	Hot-Dipped Galvanized	3" ID 3 3/4" OD	100 lbs.	3.3
3-RAH-7 SS	8" (203.2)	14" (355.6)	3" (76.2)	Stainless Steel	3" ID 3 3/4" OD	100 lbs.	3.3
4-RAH-7 HG	12.07" (306.6)	16.07" (408.2)	5" (127.0)	Hot-Dipped Galvanized	4" ID 5" OD	150 lbs.	6.8
4-RAH-7 SS	12.07" (306.6)	16.07" (408.2)	5" (127.0)	Stainless Steel	4" ID 5" OD	150 lbs.	5.8

Note: Optional 3-RAH Pipe Strap aluminum w/SS Screws

**Unipier® Rooftop Pipe Support System - Accessories**

**Spacer for Model 1.5 and Model 3-R**

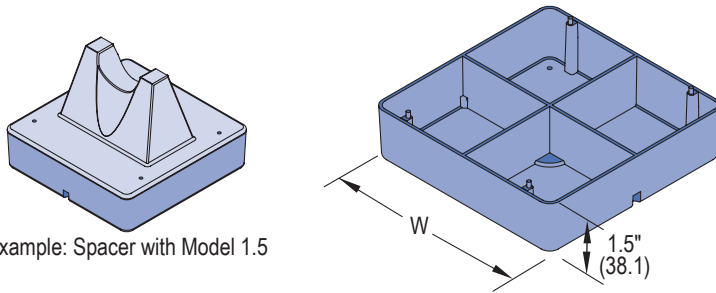

Example: Spacer with Model 1.5

Part Number	Use With	"W"	Added Pipe Clearance	Wt./Ea.
1.5 Spacer	1.5	6"	1 1/2"	0.43 lbs
3-R Spacer	3-R-2 or 3-R-4	7-1/2"	2"	0.75 lbs

Material: Polycarbonate

**Support Pad, Polycarbonate**

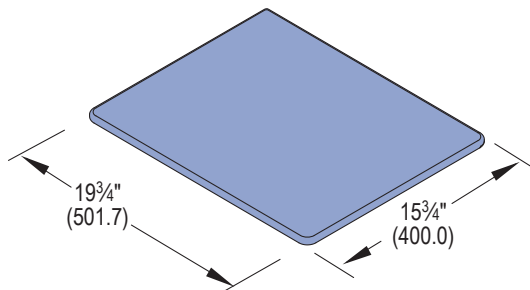

The Unipier support pad is designed to provide a barrier between the roof membrane and rooftop equipment. The support pad is 1/8" thick and are compatible with all current types of decking and commonly used built-up and single-ply roof membranes.

Support pads should be installed in the following areas:

- Under all Unipier pipe supports. The pipe support must be placed evenly over the support pad.
- In high traffic points or where regular maintenance is necessary to service rooftop equipment.

When installing the support pad, remove all rock, aggregate, dirt and excess dust from an area of the roof membrane slightly larger than the support pad. Then, apply the support pad on the cleaned area and center the Unipier pipe support on the rooftop pad.

The maximum roof top load should not exceed 5 p.s.i. The rooftop pad can withstand higher loading, but the roof membrane and insulation are typically limited to 5 p.s.i.

**Deck Plate, Stainless Steel**

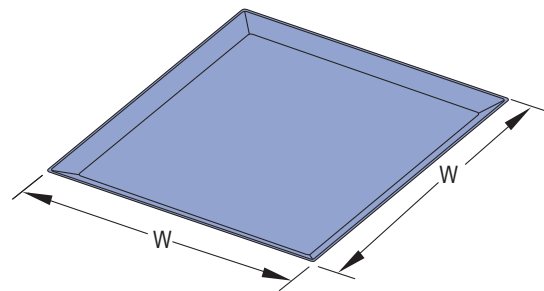

Part Number	Material	Width "W"	Wt./Each
Deck Plates 12 SS	Stainless Steel	12"	2.0 lbs.
Deck Plates 18 SS	Stainless Steel	18"	4.5 lbs.



Polycarbonate Base

Model 6-H Base P

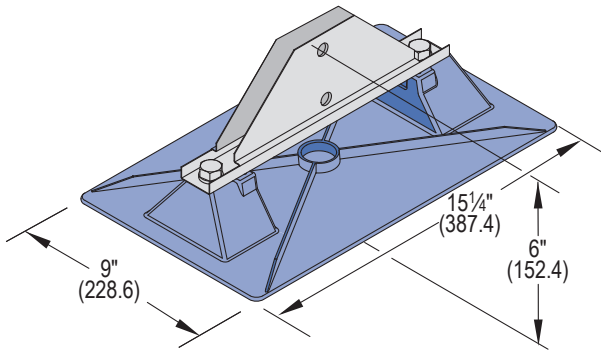

Note: Maximum 150 lbs. Load  
Wt./Ea.: 2.5 lbs.

Model 8-H-DB Base P

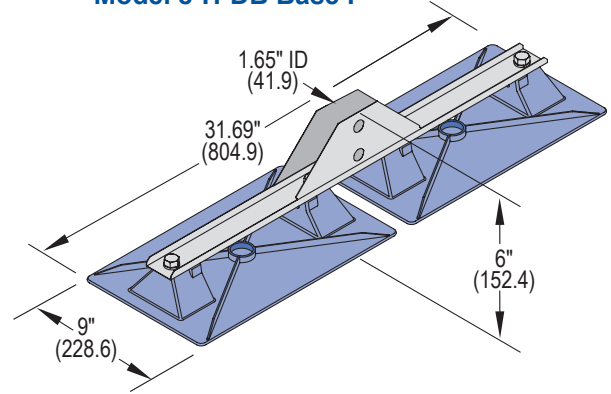

Note: Maximum 350 lbs. Load  
Wt./Ea.: 4.5 lbs.

Model 16-H Base P

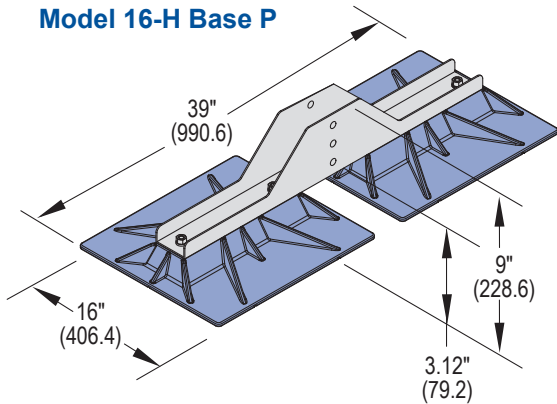

Note: Maximum 350 lbs. Load  
Wt./Ea.: 18.5 lbs.

Stainless Steel / Hot Dip Galvanized Steel Base

Model 6-H, 8-H, 16-H Base HG or S.S.

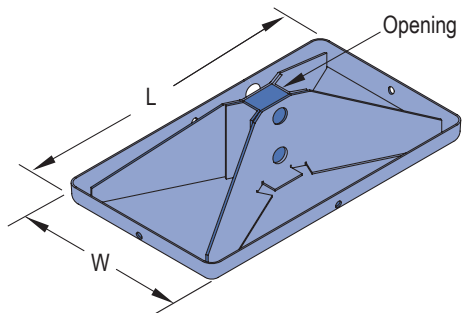

Part Number	"W"	"L"	"Opening"
6-H Base HG	8" (203.2mm)	14" (355.6mm)	1-5/8" x 7/8" (41.3 x 22.2)
6-H Base SS	8" (203.2mm)	14" (355.6mm)	1-5/8" x 7/8" (41.3 x 22.2)
8-H Base HG	16" (406.4mm)	12" (304.8mm)	1-5/8" x 1-5/8" (41.3 x 41.3)
8-H Base SS	16" (406.4mm)	12" (304.8mm)	1-5/8" x 1-5/8" (41.3 x 41.3)
16-H Base HG	20" (508.0mm)	20" (508.0mm)	3" x 3" (76.2 x 76.2)
16-H Base SS	20" (508.0mm)	20" (508.0mm)	3" x 3" (76.2 x 76.2)



**Single Base Trapeze**

1 1/8" Channel

Telestrut

Nuts & Hardware

General Fittings

Pipe/Conduit Supports

Electrical Fittings

Concrete Inserts

Solar

Unipier®

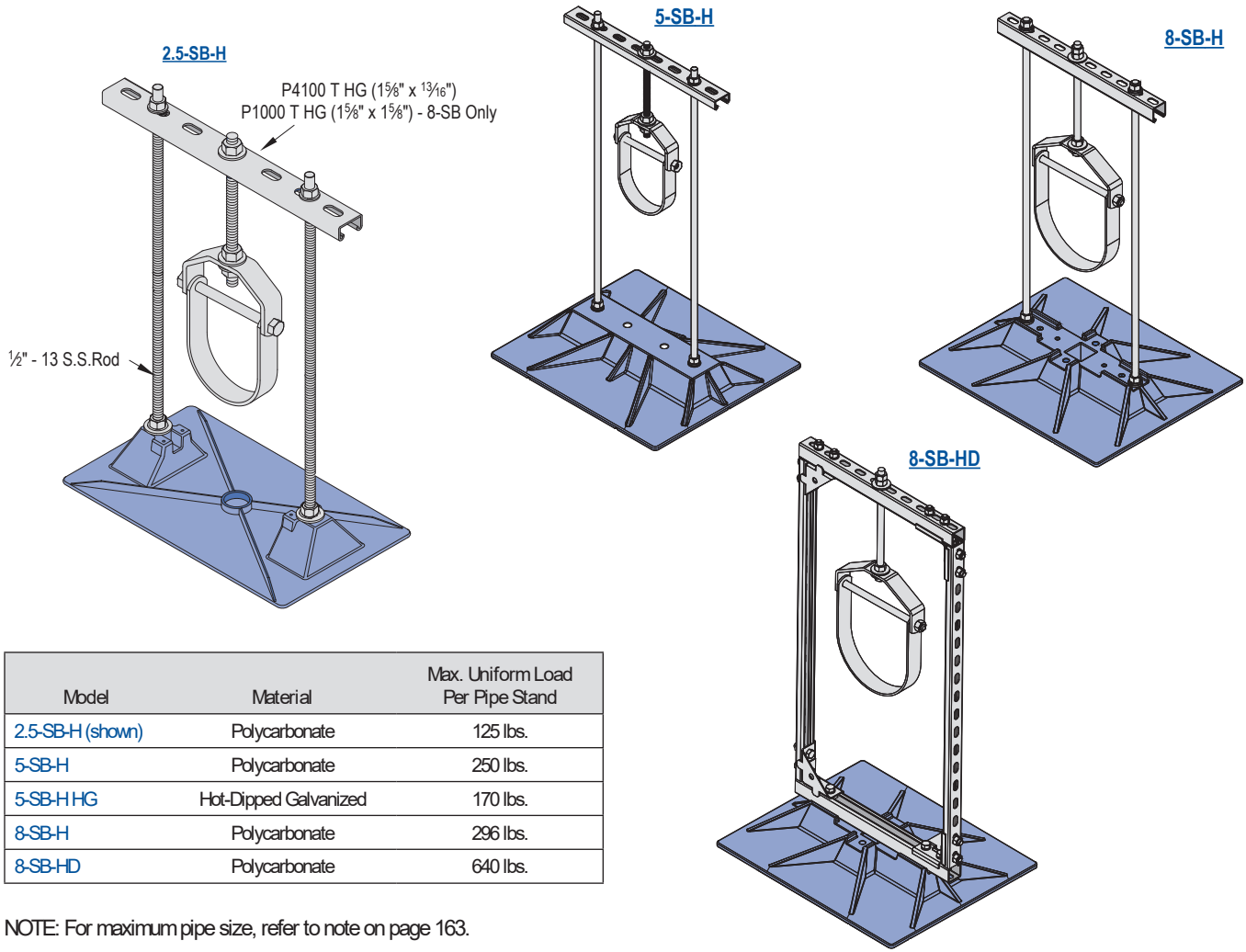

Model	Material	Max. Uniform Load Per Pipe Stand
2.5-SB-H (shown)	Polycarbonate	125 lbs.
5-SB-H	Polycarbonate	250 lbs.
5-SB-H HG	Hot-Dipped Galvanized	170 lbs.
8-SB-H	Polycarbonate	296 lbs.
8-SB-HD	Polycarbonate	640 lbs.

NOTE: For maximum pipe size, refer to note on page 163.

### Double Base Trapeze

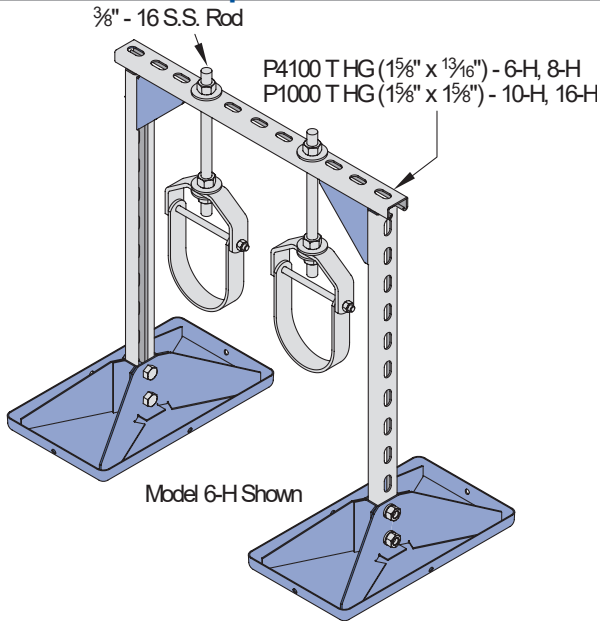

Model	Material	Max. Uniform Load Per Pipe Stand	Max. Pipe Capacity
6-HP	Polycarbonate	300 lbs.	7 1/2"
8-HP	Polycarbonate	700 lbs.	9"
6-H-HG	Hot-Dipped Galvanized	300 lbs.	7 1/2"
6-H-SS	Stainless Steel	300 lbs.	7 1/2"
8-H-HG	Hot-Dipped Galvanized	700 lbs.	9"
8-H-SS	Stainless Steel	700 lbs.	9"
10-HP	Polycarbonate	1,600 lbs.	9"
16-H-HG	Hot-Dipped Galvanized	1,600 lbs.	18"
16-H-SS	Stainless Steel	1,600 lbs.	18"

### Heavy Duty Double Base Trapeze

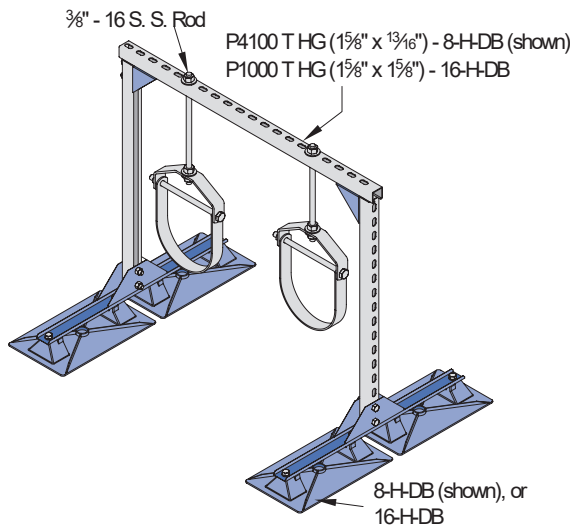

Model	Max. Uniform Load Per Pipe Stand	Max. Pipe Capacity
8-H-DB	700 lbs.	9"
16-H-DB	1,600 lbs.	18"

Base Material: Polycarbonate

### Double Base Duct Support

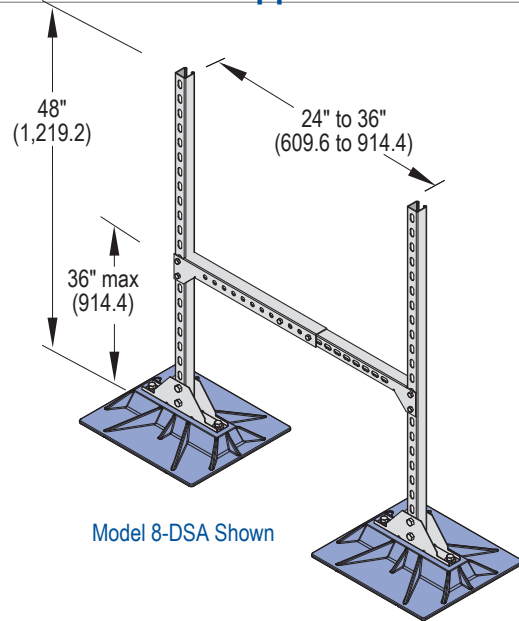

Model	Material	Max. Uniform Load Per Duct
6-DSA	Polycarbonate	150 lbs.
8-DSA	Polycarbonate	300 lbs.

### Double Base Duct Support

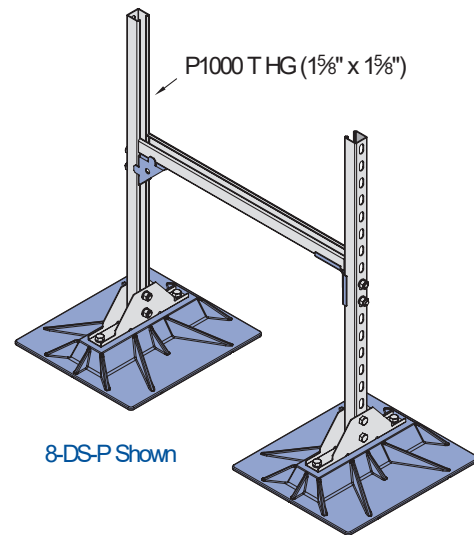

Model	Material	Max. Uniform Load Per Duct
6-DS-P	Polycarbonate	150 lbs.
6-DS-HG	Hot-Dipped Galvanized	300 lbs.
6-DS-SS	Stainless Steel	300 lbs.
8-DS-P	Polycarbonate	300 lbs.
8-DS-HG	Hot-Dipped Galvanized	300 lbs.
8-DS-SS	Stainless Steel	300 lbs.
8-DS-DB-P	Polycarbonate	300 lbs.
10-DS-P	Polycarbonate	300 lbs.



1 1/8" Channel

Telestrut

Nuts & Hardware

General Fittings

Pipe/Conduit Supports

Electrical Fittings

Concrete Inserts

Solar

Unipier®

**Heavy Duty Mechanical Support**

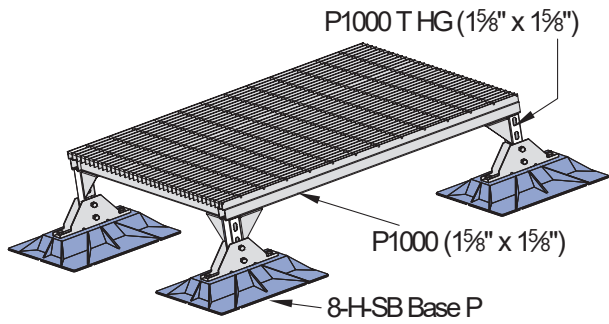

**Light Duty Mechanical Support**

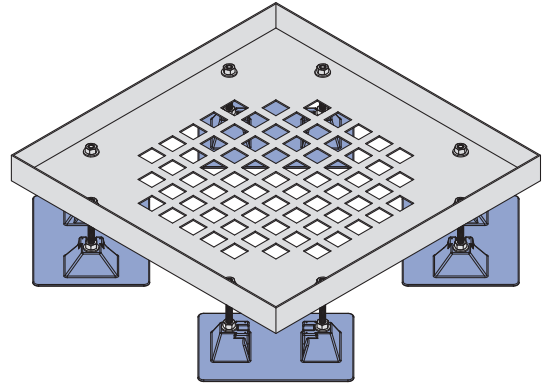

Note: Adjustable height, maximum load 200 lbs.  
Available Sizes: 18" x 18", 24" x 24", 30" x 30", 36" x 36"  
Note: Custom sizes available, Contact Unistrut for information.

**Bridge Cross-Over, Walkway, Service Platform or Ramp**

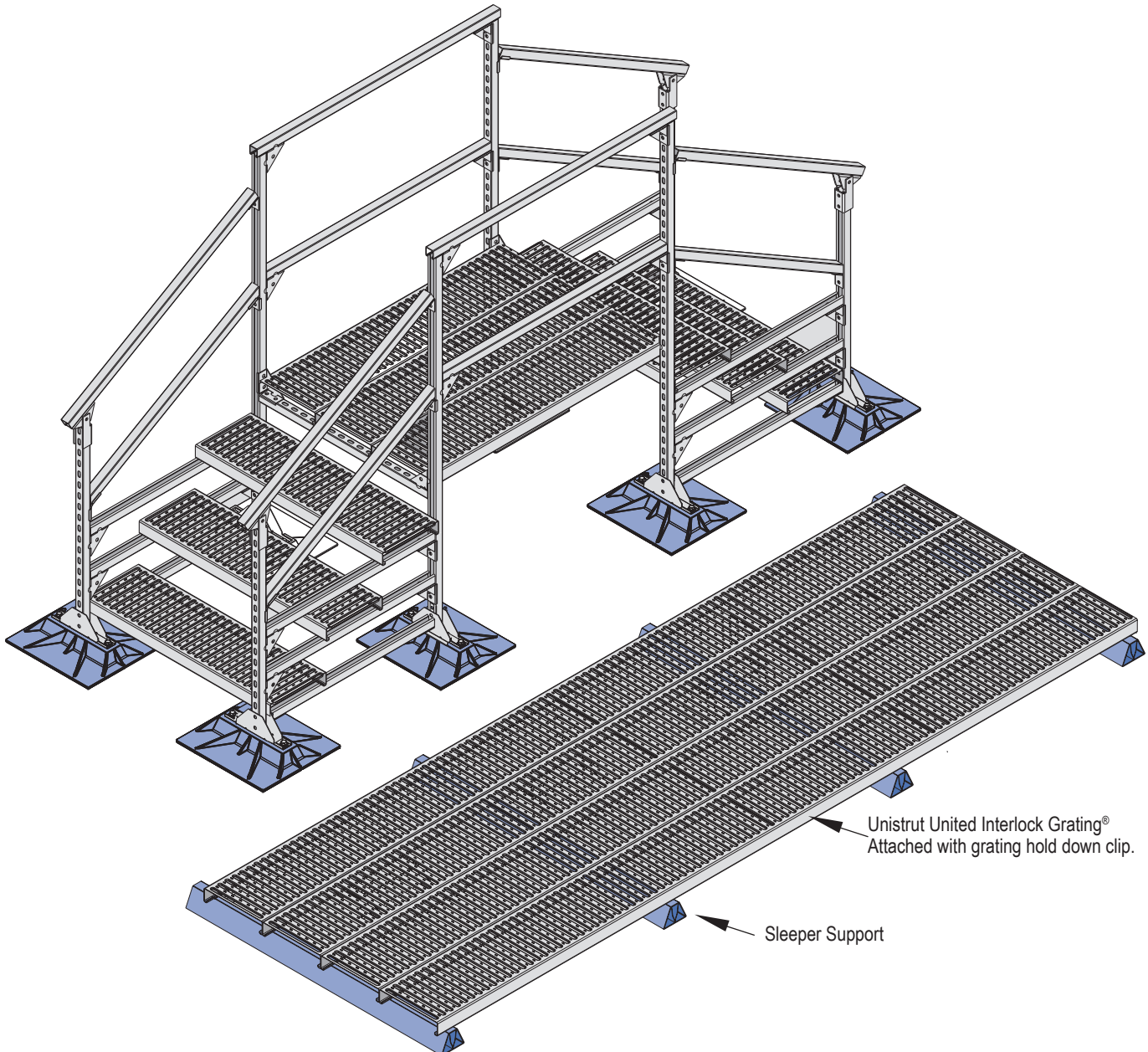

## Product Description:

A pipe support used to support roof mounted gas pipes, electrical conduit, solar piping and other mechanical piping. Unique design absorbs thermal expansion and contraction of pipes thus preventing damage to the roof membrane. Pipes rests include:

- "U" shaped cradle situated in a polycarbonate resin seat.
- Self-lubricating roller polycarbonate resin rod and roller. As daytime temperatures warm the roof membrane and the mechanical pipe network found on the roof, causing them to expand, the roller bearing in the pipe stand rolls beneath the pipe it supports. A difference between night and day temperatures of 20° F. causes 100 ft. of 1" steel pipe to move as much as 1/4".
- A strut system constructed of hot-dipped galvanized steel components including devis hangers or band hangers.
- For the duct supports, the ducts rest on a 1 5/8" x 1 5/8" or 1 5/8" x 7/8" Unistrut channel and are adjustable in height.

## Composition and Material:

Support base is made of polycarbonate resin or hot-dipped galvanized or stainless steel as indicated for the specific base. The base is gently rounded to prevent gouging the roof membrane. Carbon black is added to the polycarbonate resin for UV resistance and protection.

Pipe Roller is made of polycarbonate, or steel as indicated for the specific part.

Other Metal Parts are made of hot-dipped galvanized or stainless steel.

Duct Supports are made of hot-dipped galvanized Unistrut channel

All-Thread Rod are 1/2" or 3/8" stainless steel and are used for vertical supports.

## Compatibility:

Pillow Block Pipe Stands are recommended for use on and compatible with all current types of decking and with all commonly used built-up and single-ply roofing membranes where roof-mounted pipes occur. For heavier loads it is prudent to use a Unipier Support Pad or other traffic pad to further protect the roof membrane.

## Adjustable Height:

Several models allow adjustable height as desired or required by the code or roof system. Each model can be configured to allow plus or minus height above the roof. Purchasers should specify desired heights upon ordering the pillow block hangers.

## Installation Process:

1. Center the support beneath the pipes or ducts so that the pipe or ducts are squarely over the pipe stand.
2. For adjustable models, adjust the support to the desired height and to ensure a uniform load with other supports. Make certain the horizontal support strut is level.
3. Place the pipe or duct on the support without dropping or causing undue impact.

For heavier loads it is prudent to install an additional sheet of roofing material, a Unipier Deck Plate, or Unipier Support Pad beneath the duct support.

For built-up roofs, all loose aggregate from an area 2" larger than each base should be removed from the area directly beneath the support. Care should be taken to install each support so it supports a proportional and equal amount of weight at each support.

## Optional Straps:

For many of the models, the pipe may be secured to the pipe stand by using optional Unipier Pipe Straps.

## Note:

When using a pipe strap, allow sufficient room between the pipe and the strap to allow free movement of the pipe without binding.

## Loads and Spacing:

Unistrut recommends that spacing not exceed 10' between centers depending upon the load. Make certain each pipe stand is properly elevated to ensure a uniform load weight at all pipe stands and not exceed the load specified for the particular model support. All loads given in this catalog are for uniformly distributed loads.

## Maintenance:

Normally maintenance is not required. Semi-annual inspection is required to check pipe stand position and set pipe alignment, weight distribution and improper installation which may cause pipe stand damage or failure.



**Typical Steel Pipe Weights – Pipe Standing Load**

For Schedule 40 Steel Pipe. (ASTMA53-86)

Pipe Size	Pounds per Foot of Pipe Empty	Pounds per Foot Containing Gas		PSI per Foot on Model 6-RAH-7 BASE	5 Feet Spacing	7.5 Feet Spacing	10 Feet Spacing
		Pounds per Foot Containing Water	PSI per Foot on Model 6-RAH-7 BASE				
3"	7.575	7.578	.02	37.89 lbs. .13 psi	56.84 lbs. .20 psi	75.78 lbs. .26 psi	
		13.4	.04	67.00 lbs. .23 psi	100.50 lbs. .35 psi	134.00 lbs. .47 psi	
4"	10.790	10.794	.03	53.97 lbs. .19 psi	80.96 lbs. .28 psi	107.94 lbs. .37 psi	
		16.3	.05	81.50 lbs. .28 psi	122.25 lbs. .42 psi	163.00 lbs. .57 psi	
5"	14.620	14.627	.04	73.14 lbs. .25 psi	109.7 lbs. .38 psi	146.27 lbs. .51 psi	
		23.2	.07	116.00 lbs. .40 psi	174.00 lbs. .60 psi	232.00 lbs. .80 psi	
6"	18.970	18.98	.05	94.49 lbs. .33 psi	142.35 lbs. .49 psi	189.80 lbs. .66 psi	
		31.5	.09	157.50 lbs. .55 psi	236.25 lbs. .82 psi	315.00 lbs. 1.09 psi	
8"	28.55	28.567	.08	142.84 lbs. .50 psi	214.25 lbs. .74 psi	285.67 lbs. .99 psi	
		50.1	.14	250.00 lbs. .87 psi	375.75 lbs. 1.30 psi	501.00 lbs. 1.74 psi	
10"	40.48	40.507	.12	202.54 lbs. .70 psi	303.80 lbs. 1.05 psi	405.07 lbs. 1.41 psi	
		74.6	.21	373.00 lbs. 1.30 psi	559.50 lbs. 1.94 psi	746.00 lbs. 2.60 psi	

PSI is in pounds per square inch on models 6-RAH-7 BASE, which contain 2 bases for a total of 288 square inches of roof contact area support.

**Typical Pipe Diameters**

PIPE	PVC (Steel Size)	PVC (C900)	Cast Iron	Steel	Conduit
Inside Diameter	Outside Diameter	Outside Diameter	Outside Diameter	Outside Diameter	Outside Diameter
1/2"	.84"	–	–	.84"	.840"
3/4"	1.05"	–	–	1.05"	1.050"
1"	1.32"	–	–	1.32"	1.315"
1 1/4"	1.66"	–	–	1.66"	1.660"
1 1/2"	1.90"	–	–	1.90"	1.90"
2"	2.38"	2.50"	2.50"	2.38"	2.375"
2 1/2"	2.88"	–	–	2.88"	2.875"
3"	3.50"	–	3.96"	3.50"	3.500"
3 1/2"	–	–	–	–	4.000"
4"	4.50"	4.80"	5.00"	4.50"	4.500"
5"	–	–	–	5.56"	5.563"
6"	6.63"	6.90"	7.22"	6.63"	6.625"
8"	8.63"	9.05"	9.42"	8.63"	–
10"	10.75"	11.10"	11.60"	10.75"	–

Unipier Specifications for Typical Bases

Base Model	Outside Dimension at Roof Contact (in.)	Roof Contact Area (in. <sup>2</sup> )	Allowable Loading in Pounds	PSI on Roof for Each Base Under Maximum Load	Composition of Material of Base
1.5	6 X 6	24.42	80	3.27	P
1.5 SPACER	6 X 6	33.06	80	2.41	P
2.5-CS-2, 2.5-CS-5, 2.5-CS-7	7.5 X 10	57.50	100	1.73	P
2.5-CS-12	9 X 15.25	111.75	100	0.89	P
2.5-SB-HP	9 X 15.25	111.75	125	1.11	P
3-R-2; 3-R-4	7.75 X 7.75	39.64	100	2.52	P
3-R SPACER	7.25 X 7.25	52.56	100	1.90	P
3-RAH-7	7.5 X 10	57.50	100	1.73	P
3-RAH-12	9 X 15.25	111.75	100	1.11	P
3-RAH-7 HG/ SS	8 X 14	96.06	100	1.04	HG/ SS
4-RAH-7 HG/ SS	12 X 16	174.89	150	0.85	HG/ SS
5-R; 5-RAH-7; 5-RAH-12	9 X 15.25	111.75	150	1.34	P
5-SB-H HG	12 X 16	174.89	170	0.97	HG/ SS
5-SB-HP	16 X 18	220.32	250	1.13	P
6-RAH-7; 6-RAH-12	16 X 18	220.32	250	1.13	P
6-RAH-7 HG/SS; 6-RAH-RS HG/SS	12 X 16	174.89	150	0.85	HG/ SS
6-HP (used in pairs)	9 X 15.25	223.50	310	1.38	P
6-H (2 Bases) HG/ SS	8 X 14	192.12	310	1.61	HG/ SS
8-H-DB-P (used in pairs)	9 X 31.69	447.00	700	1.56	P
8-H HG/ SS (used in pairs)	12 X 16	349.78	700	2.00	HG/ SS
8-RAH-18	19 x 23	325.98	640	1.96	P
8-SB-H	19 x 23	325.98	640	1.96	P
10-H-DS P	19 x 23	325.98	640	1.96	P
12-BS-7 HG/ SS	12 X 16	174.89	150	0.85	HG/ SS
16-BS-7; 16-BS-12	9 X 15.25	111.75	125	1.11	P
16-BS-7 HG/ SS	12 X 16	174.89	150	0.85	HG/ SS
16-HP (used in pairs)	16 X 39	881.28	1600	1.81	P
16-H HG/ SS (used in pairs)	20 X 20	800.00	1600	2.00	HG/ SS
20-BS-7; 20-BS-12	16 X 18	220.32	250	1.13	P
24-BS-4; 24-BS-18	19 x 23	325.98	640	1.96	P

P – Polycarbonate Resin, SS – Stainless Steel - ASTM No. 304, HG – Hot-Dipped Galvanized

Note: Care should be taken to properly engineer the roof design so as to not overload the actual limits or manufacturer's recommended limits for each pipe support, the roof membrane, the roof top insulation, or the roof structure.

Note: Unipier has set the above load limits for each base to come within usual and customary roof structure, roof insulation, and roof membrane load limits. Unipier's manufacturing recommendations do not replace actual engineering required for each specific job.

1 1/8" Channel

Telestrut

Nuts & Hardware

General Fittings

Pipe/Conduit Supports

Electrical Fittings

Concrete Inserts

Solar

Unipier®



**Technical Properties For Polycarbonate Resin\***

PROPERTY	ASTM TEST METHOD	VALUE
<b>PHYSICAL</b>		
Specific Gravity	D792	1.20
Specific Volume, in <sup>3</sup> /lb (cm <sup>3</sup> /g)	–	23.1 (0.83)
Weight/Volume, lbs/in <sup>3</sup> (g/cm <sup>3</sup> )	–	0.043 (1.20)
Water Absorption %	D570	–
24 hours @73°F (23°C)	–	0.15
Equilibrium, 73°F (23°C)	–	0.35
Equilibrium, 212°F (100°C)	–	0.58
Mold Shrinkage, in/in (mm/mm)	D955	0.005-0.007
Light Transmittance, % at 0.125"	D1003	89
Haze, % @0.125"	D1003	1
Refractive Index	–	1.586
<b>THERMAL</b>		
Deflection Temperature °F (°C)	D648	–
@66 psi (0.46 MPa)	–	–
@254 psi (1.82 MPa)	–	270 ( )
Specific Heat, Btu/lb°F (kJ/kg°K)	–	0.30 (1.25)
Thermal Conductivity	–	–
Btu-in/h-ft <sup>2</sup> °F (W/Km)	–	1.35 (.19)
Coefficient of Thermal Expansion	–	–
in/in°F (m.m°C)	D696	3.75 x 10 <sup>-5</sup> (6.75 s 10 <sup>-5</sup> )
Vicat Softening Temperature, °F (°C)	D1525	305-315 (152-157)
Viscosity Midpoint	D1238	9.5
(Melt Flow Rate) g/10 min.	Condition 0	–
Brittleness Temperature, °F (°C)	D746	<-200 (-129)
Flammability Ratings	–	–
ASTM	D365°	AEB>1"
UL Standard 94° 1/16 (1.6 mm)	UL94	V-2
UL Standard 94° 1/8" (3.2 mm)	UL94	V-2
Oxygen Index	D2863	25.0
<b>PHYSICAL</b>		
Dielectric Strength, volts/mil (kV/mm)	D149	380 (15.0)
Short time, 125 mils (3.2mm)	–	–
Dielectric Constant	D150	–
60 Hz	–	3.17
106 Hz	–	2.96
Dielectric Factor	D150	–
60 Hz	–	0.0009
106 Hz	–	0.010
Volume Resistivity, ohm-cm	–	D257
@73°F, dry (23°C)	–	>10 <sup>16</sup>
Arc Resistance, sec	D495	–
Stainless Steel Electrodes	–	10-11
Tungsten Electrodes	–	120

PROPERTY	ASTM TEST METHOD	VALUE
<b>MECHANICAL</b>		
Tensile Strength, psi (MPa)	D638	–
Yield	–	9,000 (62)
Ultimate	–	10,000 (69)
Elongation, %	D638	–
Rupture	–	130
Flexural Strength, psi (MPa)	D790	14,000 (97)
Flexural Modules, 10 <sup>6</sup> psi (MPa)	D790	3.40 (2,300)
Compressive Strength, psi (MPa)	D695	12,500 (86)
Compressive Modules, psi (MPa)	D695	–
10 <sup>6</sup> osu (MPa)	–	3.45 (2,400)
Shear Strength, psi (MPa)	D732	–
Yield	–	6,000 (40)
Ultimate	–	10,000 (70)
Shear Modules, 10 <sup>6</sup> psi (MPa)	–	1.14 (790)
Izod Impact Strength, ft-lbs/in (J/m)	D1822	–
Notched, 1/8" thick (3.22mm)	–	15 (801)
Tensile Impact Strength, ft-lbs/in <sup>2</sup> (kJ/m <sup>2</sup> )	D1822	–
S-type	–	275 (579)
Dynatup Impact Strength, ft-lbs/in (J)	D3763	47 (64)
Fatigue Strength, psi @2.5mm	D671	–
cycles (MPa)	–	1,000 (7.0)
Rockwell Hardness	D785	–
M	–	70
R	–	118
Deformation Under Load %	D621	–
4000 psi @ 73°F (27 MPa @ 23°C)	–	0.2
4000 psi @ 158°F (27 MPa @ 70°C)	–	0.5
Taber Abrasion Resistance	–	–
Weight Loss, mg/1000 cycles	D1044	10

\*Polycarbonate Resin is used in all models indicated in catalog as Polycarbonate, and in all rollers.

1 1/8" Channel

Telestrut

Nuts & Hardware

General Fittings

Pipe/Conduit Supports

Electrical Fittings

Concrete Inserts

Solar

Unipier®



# 1¼" FRAMING SYSTEM

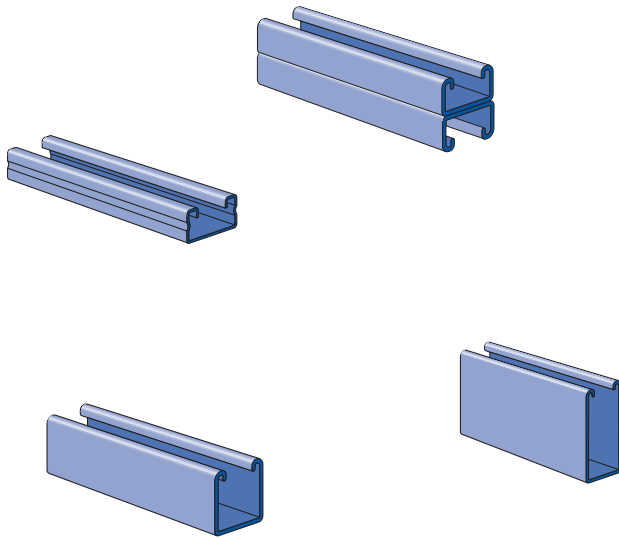

A1000 (14 Gauge) .....	171 - 172
A3300 (14 Gauge) .....	173 - 174
Channel Nuts and Closure Strips .....	175
Flat Plate Fittings .....	175 - 176
Ninety Degree Fittings.....	176
Angle and Wing Shape Fittings .....	176
"U" Shape Fittings .....	177
Pipe / Tubing Clips .....	177
Brackets .....	177

## MATERIAL

Unistrut channels are accurately and carefully cold formed to size from low-carbon strip steel.

### STEEL: PLAIN

- 14 Gauge (1.9 mm), ASTM A1011 SS GR 33
- 19 Gauge (1.0 mm) ASTM A1008

### STEEL: PRE-GALVANIZED

- 14 Gauge (1.9 mm) ASTM A653 GR 33,
- 19 Gauge (1.0 mm) ASTM A653 GR 33

Channel nuts are manufactured from mild steel bars conforming to ASTM A576, GR 1015, and are case hardened.

Fittings are made from hot rolled, pickled and oiled steel plate or strip and conform to ASTM A1011 SS GR 33.

Many framing channels are available in special metal on request. Consult factory for ordering information.

## FINISHES

All channels and fittings are available in: Perma-Green III (GR), Pre-galvanized (PG), conforming to ASTM A653 GR 33 and plain (PL).

Nuts are available in plain or electro-galvanized (EG) finish.

Fittings are available in Perma-Green III (GR) or plain (PL).

## STANDARD LENGTHS

Standard lengths are 10 feet (3.05M) and 20 feet (6.10M). Tolerances are: +1/8" (3.2 mm) to +1/2" (12.7 mm) to allow for cutting. Special lengths are available for a small cutting charge with a tolerance of ±1/8" (3.2mm).

## APPLICATION

A framing system designed for medium loads, the 1¼" series is especially suitable for use in the OEM, commercial and display markets. It maintains a lightness in scale and a clean line that makes it aesthetically pleasing as well as functional.

## THREADS

All threads on the nuts and bolts are Unified and American coarse screw threads.

## DESIGN BOLT TORQUE

BOLT SIZE	¼"-20	⅜"-18	½"-16
Rec. Torque Ft/Lbs (N•m)	6 (8)	11 (15)	19 (26)
Max Torque Ft/Lbs (N•m)	7 (9)	15 (20)	25 (34)

## DIMENSIONS

Imperial dimensions are illustrated in inches. Metric dimensions are shown in parenthesis or as noted. Unless noted, all metric dimensions are in millimeters and rounded to one decimal place.

## LOAD DATA

All beam and column load data pertains to carbon steel and stainless steel channels. Load tables and charts are constructed to be in accordance with the SPECIFICATION FOR THE DESIGN OF COLD-FORMED STEEL STRUCTURAL MEMBERS 2007 EDITION published by the AMERICAN IRON AND STEEL INSTITUTE USING ASD METHOD. Loads are based on 33 ksi steel cold formed to 42 ksi.

Type of Load	Safety Factor to Yield Strength	Safety Factor to Ultimate Strength
Beam Loads	1.67	2.0
Column Load	1.80	2.2



1 1/4" System

**A1000 Series**

1 1/4" x 1 1/4"  
14 Ga.

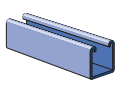

A1000-Pg 171

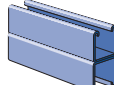

A1001-Pg 171

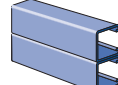

A1001 A-Pg 172

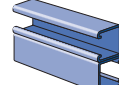

A1001 B-Pg 172

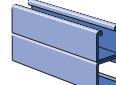

A1001 C-Pg 172

**A3300 Series**

1 1/4" x 3/4"  
14 Ga.

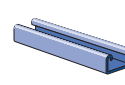

A3300-Pg 173

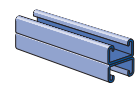

A3301-Pg 173

1 3/16" System

**Channel Nuts & Closures**



A1006-1420-Pg 175



A4006-1420-Pg 175

Fiberglass System



A3006-1420-Pg 175



A3016-0832-Pg 175



A1280-Pg 175



A4280-Pg 175

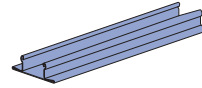

A1184-Pg 175

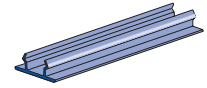

A1184P-Pg 175

Special Metals

**A Series Fittings**



A1063-Pg 176



A1065-Pg 176

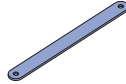

A1191-Pg 176



A1066-Pg 176

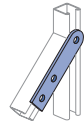

A2324-Pg 176



A1036-Pg 176

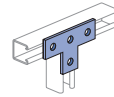

A1031-Pg 176



A1026-Pg 176

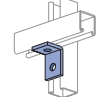

A1068-Pg 176

PrimeAngle

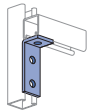

A1326-Pg 176

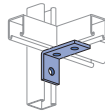

A1458-Pg 176

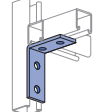

A1325-Pg 176

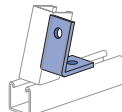

A2110-Pg 176

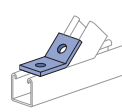

A2126-Pg 176

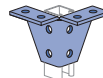

A2084-Pg 176



A2472 R-L-Pg 176

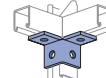

A2223-Pg 176

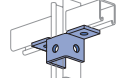

A2345-Pg 176

Metal Grating

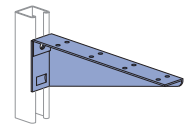

A2494 R-Pg 177

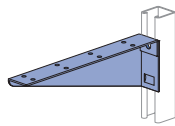

A2494 L-Pg 177

Roofwalk

Index

**A1000 & A1001 Channels**

**A1000 – 1 1/4" x 1 1/4"**

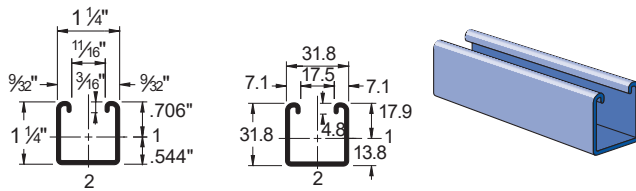

WW/100 Ft: 104 Lbs (154 kg/100m)  
Allowable Moment 2,170 In-Lbs (240 N\*m)  
14 Gauge Nominal Thickness .075" (1.9mm)

**A1001 – 1 1/4" x 2 1/2"**

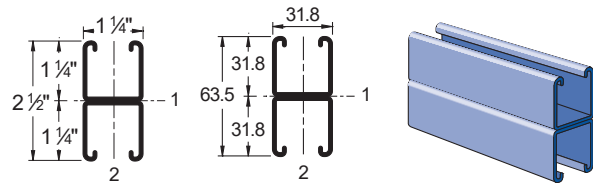

WW/100 Ft: 207 Lbs (308 kg/100m)  
Allowable Moment 6,070 In-Lbs (690 N\*m)  
14 Gauge Nominal Thickness .075" (1.9mm)

**A1000 - BEAM LOADING**

Span In	Max Allowable Uniform Load Lbs	Defl. at Uniform Load In	Uniform Loading at Defl.		
			Span/180 Lbs	Span/240 Lbs	Span/360 Lbs
18	960	0.04	960	960	960
24	720	0.07	720	720	660
36	480	0.16	480	440	300
48	360	0.29	330	250	170
60	290	0.45	210	160	110
72	240	0.65	150	110	70
84	210	0.90	110	80	50
96	180	1.16	80	60	40
108	160	1.46	70	50	30
120	140	1.75	50	40	30

**A1001 - BEAM LOADING**

Span In	Max Allowable Uniform Load Lbs	Defl. at Uniform Load In	Uniform Loading at Defl.		
			Span/180 Lbs	Span/240 Lbs	Span/360 Lbs
18	1,650*	0.01	1,650*	1,650*	1,650*
24	1,650*	0.03	1,650*	1,650*	1,650*
36	1,350	0.09	1,350	1,350	1,350
48	1,010	0.16	1,010	1,010	820
60	810	0.26	810	790	530
72	670	0.37	670	550	370
84	580	0.50	540	400	270
96	510	0.66	410	310	210
108	450	0.83	330	240	160
120	400	1.01	260	200	130

**A1000 - COLUMN LOADING**

Unbraced Height In	Maximum Allowable Load at Slot Face Lbs	Maximum Column Load Applied at C.G.			
		K = 0.65 Lbs	K = 0.80 Lbs	K = 1.0 Lbs	K = 1.2 Lbs
18	1,960	5,900	5,430	4,800	4,210
24	1,840	5,210	4,590	3,850	3,220
36	1,500	3,940	3,220	2,480	2,010
48	1,220	2,950	2,300	1,790	1,460
60	1,020	2,260	1,790	1,400	1,130
72	880	1,840	1,460	1,130	910
84	780	1,550	1,230	940	**
96	690	1,340	1,050	**	**
108	620	1,170	910	**	**

**A1001 - COLUMN LOADING**

Unbraced Height In	Maximum Allowable Load at Slot Face Lbs	Maximum Column Load Applied at C.G.			
		K = 0.65 Lbs	K = 0.80 Lbs	K = 1.0 Lbs	K = 1.2 Lbs
18	3,530	13,300	12,920	12,400	11,880
24	3,480	12,750	12,220	11,550	10,950
36	3,370	11,630	10,950	10,220	9,150
48	3,260	10,680	10,020	8,260	6,500
60	2,960	9,930	8,260	6,080	4,270
72	2,630	8,480	6,500	4,270	2,970
84	2,260	7,040	4,900	3,140	2,180
96	1,940	5,680	3,750	2,400	**
108	1,670	4,490	2,970	**	**
120	1,440	3,640	2,400	**	**

**A1000/A1001 - ELEMENTS OF SECTION**

Parameter	A1000		A1001	
Area of Section	0.305	In <sup>2</sup>	0.609	In <sup>2</sup>
Axis 1-1				
Moment of Inertia (I)	0.061	In <sup>4</sup>	0.302	In <sup>4</sup>
Section Modulus (S)	0.086	In <sup>3</sup>	0.242	In <sup>3</sup>
Radius of Gyration (r)	0.447	In	0.704	In
Axis 2-2				
Moment of Inertia (I)	0.078	In <sup>4</sup>	0.156	In <sup>4</sup>
Section Modulus (S)	0.125	In <sup>3</sup>	0.250	In <sup>3</sup>
Radius of Gyration (r)	0.506	In	0.506	In

Notes:

\* Load limited by spot weld shear.

\*\* KL/r > 200

NR = Not Recommended.

1. Beam loads are given in total uniform load (WLbs) not uniform load (w lbs/ft or w lbs/in).
2. Beam loads are based on a simple span and assumed to be adequately laterally braced. Unbraced spans can reduce beam load carrying capacity. Refer to Page 177 for reduction factors for unbraced lengths.
3. Deduct channel weight from the beam loads.
4. For concentrated midspan point loads, multiply beam loads by 50% and the corresponding deflection by 80%. For other load conditions refer to page 18.
5. All beam loads are for bending about Axis 1-1.



1 1/4" System

1 3/16" System

Fiberglass System

Special Metals

PrimeAngle

Metal Grating

Roofwalk

Index

**A1000 - BEAM LOADING (METRIC)**

Span mm	Max Allowable Uniform Load kN	Defl. at Uniform Load mm	Uniform Loading at Deflection		
			Span/180 kN	Span/240 kN	Span/360 kN
600	3.2	2	3.2	3.2	3.1
750	2.6	3	2.6	2.6	2.0
1,000	2.0	5	2.0	1.6	1.1
1,250	1.6	8	1.4	1.1	0.7
1,500	1.3	11	1.0	0.7	0.5
1,750	1.1	15	0.7	0.5	0.4
2,000	1.0	20	0.5	0.4	0.3
2,500	0.8	32	0.4	0.3	0.2
3,000	0.7	46	0.2	0.2	0.1

**A1001 - BEAM LOADING (METRIC)**

Span mm	Max Allowable Uniform Load kN	Defl. at Uniform Load mm	Uniform Loading at Deflection		
			Span/180 kN	Span/240 kN	Span/360 kN
600	7.3*	1	7.3*	7.3*	7.3
750	7.3*	2	7.3*	7.3*	7.3
1,000	5.5	3	5.5	5.5	5.5
1,250	4.4	4	4.4	4.4	3.5
1,500	3.6	6	3.6	3.6	2.4
1,750	3.2	9	3.2	2.7	1.8
2,000	2.8	11	2.7	2.0	1.4
2,500	2.2	17	1.7	1.3	0.9
3,000	1.8	25	1.2	0.9	0.6
3,500	1.6	34	0.9	0.7	0.4

**A1000 - COLUMN LOADING (METRIC)**

Unbraced Height mm	Maximum Allowable Load at Slot Face kN	Max. Column Load Applied at C.G.			
		K = 0.65 kN	K = 0.80 kN	K = 1.0 kN	K = 1.2 kN
600	8.2	23.4	20.7	17.3	14.6
750	7.5	20.5	17.3	14.0	11.3
1,000	6.3	16.2	13.0	9.9	8.1
1,250	5.3	12.8	9.9	7.7	6.3
1,500	4.6	10.2	8.1	6.3	5.2
1,750	4.1	8.6	6.8	5.3	4.3
2,000	3.6	7.4	5.9	4.5	**
2,250	3.3	6.5	5.2	3.9	**
2,500	3.0	5.8	4.5	**	**
2,750	2.7	5.2	4.0	**	**

**A1001 - COLUMN LOADING (METRIC)**

Unbraced Height mm	Maximum Allowable Load at Slot Face kN	Max. Column Load Applied at C.G.			
		K = 0.65 kN	K = 0.80 kN	K = 1.0 kN	K = 1.2 kN
600	15.5	56.9	54.5	51.6	48.9
750	15.2	54.4	51.6	48.4	45.7
1,000	14.9	50.4	47.4	43.9	37.4
1,250	14.4	47.2	43.9	35.7	27.8
1,500	13.3	44.6	37.4	27.8	19.6
1,750	12.1	39.4	30.9	20.7	14.4
2,000	10.8	34.1	24.8	15.9	11.0
2,250	9.5	29.0	19.6	12.5	**
2,500	8.4	24.1	15.9	10.2	**
2,750	7.4	19.9	13.1	**	**

Notes:

\* Load limited by spot weld shear.

\*\* KL/r > 200

NR = Not Recommended.

1. Beam loads are given in total uniform load (WLbs) not uniform load (w lbs/ft or w lbs/in).
2. Beam loads are based on a simple span and assumed to be adequately laterally braced. Unbraced spans can reduce beam load carrying capacity. Refer to Page 177 for reduction factors for unbraced lengths.
3. Deduct channel weight from the beam loads.
4. For concentrated midspan point loads, multiply beam loads by 50% and the corresponding deflection by 80%. For other load conditions refer to page 18.
5. All beam loads are for bending about Axis 1-1.

Finishes: PL, GR, HG, PG Standard Lengths: 10' & 20'

**A1000/A1001 - ELEMENTS OF SECTION (METRIC)**

Parameter	A1000	A1001
Area of Section	1.96 cm <sup>2</sup>	3.93 cm <sup>2</sup>
Axis 1-1		
Moment of Inertia (I)	2.53 cm <sup>4</sup>	12.57 cm <sup>4</sup>
Section Modulus (S)	1.41 cm <sup>3</sup>	3.96 cm <sup>3</sup>
Radius of Gyration (r)	1.14 cm	1.79 cm
Axis 2-2		
Moment of Inertia (I)	3.25 cm <sup>4</sup>	6.50 cm <sup>4</sup>
Section Modulus (S)	2.05 cm <sup>3</sup>	4.09 cm <sup>3</sup>
Radius of Gyration (r)	1.29 cm	1.29 cm

**A1001A - 1 1/4" x 2 1/2"**

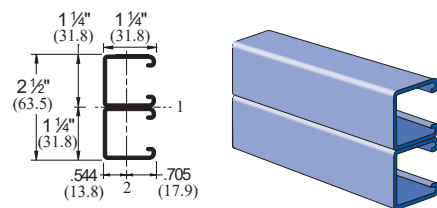

WW/100 Ft: 207 Lbs (308 kg/100m)  
Allowable Moment 7,930 In-Lbs (900 N•m)  
14 Gauge Nominal Thickness .075" (1.9mm)

**A1001B - 1 1/4" x 2 1/2"**

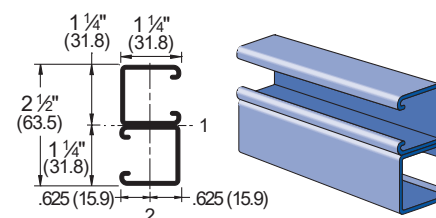

WW/100 Ft: 207 Lbs (308 kg/100m)  
Allowable Moment 7,930 In-Lbs (900 N•m)  
14 Gauge Nominal Thickness .075" (1.9mm)

**A1001C - 1 1/4" x 2 1/2"**

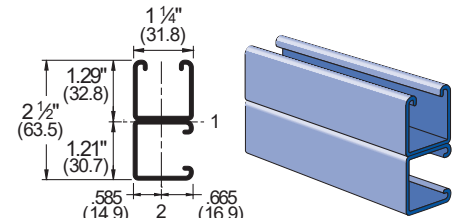

WW/100 Ft: 207 Lbs (308 kg/100m)  
Allowable Moment 6,760 In-Lbs (760 N•m)  
14 Gauge Nominal Thickness .075" (1.9mm)

**A3300 & A3301 Channels**

**A3300 – 1 1/4" x 3/4"**

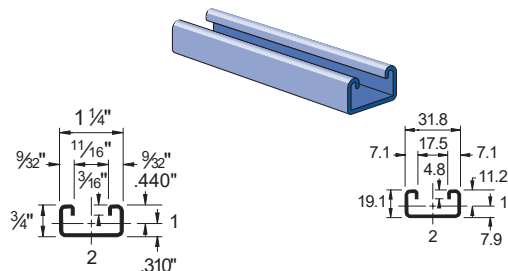

W/100 Ft: 78 Lbs (116 kg/100m)  
Allowable Moment 950 In-Lbs (110 N·m)  
14 Gauge Nominal Thickness .075" (1.9mm)

**A3301 – 1 1/4" x 1 1/2"**

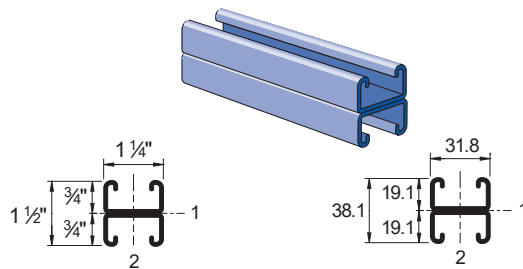

W/100 Ft: 156 Lbs (232 kg/100m)  
Allowable Moment 2,590 In-Lbs (290 N·m)  
14 Gauge Nominal Thickness .075" (1.9mm)

**A3300 - BEAM LOADING**

Span In	Max Allowable Uniform Load Lbs	Defl. at Uniform Load In	Uniform Loading at Deflection		
			Span/180 Lbs	Span/240 Lbs	Span/360 Lbs
18	420	0.07	420	420	320
24	320	0.12	320	270	180
36	210	0.26	160	120	80
48	160	0.47	90	70	50
60	130	0.75	60	40	30
72	110	1.09	40	30	20
84	90	1.42	30	20	10
96	80	1.88	20	20	10

**A3301 - BEAM LOADING**

Span In	Max Allowable Uniform Load Lbs	Defl. at Uniform Load In	Uniform Loading at Deflection		
			Span/180 Lbs	Span/240 Lbs	Span/360 Lbs
18	990*	0.03	990*	990*	990*
24	860	0.07	860	860	850
36	580	0.15	580	560	380
48	430	0.27	420	320	210
60	350	0.43	270	200	140
72	290	0.62	190	140	90
84	250	0.85	140	100	70
96	220	1.11	110	80	50

**A3300 - COLUMN LOADING**

Unbraced Height In	Maximum Allowable Load at Slot Face Lbs	Max. Column Load Applied at C.G.			
		K = 0.65 Lbs	K = 0.80 Lbs	K = 1.0 Lbs	K = 1.2 Lbs
18	1,430	4,490	4,210	3,860	3,550
24	1,370	4,090	3,750	3,310	2,680
36	1,190	3,390	2,680	1,820	1,260
48	900	2,380	1,600	1,020	**
60	680	1,550	1,020	**	**

**A3301 - COLUMN LOADING**

Unbraced Height In	Maximum Allowable Load at Slot Face Lbs	Max. Column Load Applied at C.G.			
		K = 0.65 Lbs	K = 0.80 Lbs	K = 1.0 Lbs	K = 1.2 Lbs
18	2,540	9,890	9,620	9,300	9,020
24	2,510	9,510	9,200	8,710	7,960
36	2,410	8,800	7,960	6,730	5,490
48	2,230	7,560	6,320	4,690	3,310
60	1,970	6,210	4,690	3,050	2,120
72	1,650	4,890	3,310	2,120	**
84	1,380	3,680	2,430	**	**
96	1,160	2,820	1,860	**	**

**A3300/A3301 - ELEMENTS OF SECTION**

Parameter	A3300	A3301
Area of Section	0.230	0.459
Axis 1-1		
Moment of Inertia (I)	0.017	0.077
Section Modulus (S)	0.038	0.103
Radius of Gyration (r)	0.269	0.411
Axis 2-2		
Moment of Inertia (I)	0.052	0.104
Section Modulus (S)	0.083	0.167
Radius of Gyration (r)	0.477	0.477

**Notes:**

\* Load limited by spot weld shear.

\*\* KL/r > 200

NR = Not Recommended.

1. Beam loads are given in total uniform load (W Lbs) not uniform load (w lbs/ft or w lbs/in).
2. Beam loads are based on a simple span and assumed to be adequately laterally braced. Unbraced spans can reduce beam load carrying capacity. Refer to Page 177 for reduction factors for unbraced lengths.
3. Deduct channel weight from the beam loads.
4. For concentrated midspan point loads, multiply beam loads by 50% and the corresponding deflection by 80%. For other load conditions refer to page 18.
5. All beam loads are for bending about Axis 1-1.

1 1/4" System  
1 3/16" System  
Fiberglass System  
Special Metals  
PrimeAngle  
Metal Grating  
Roofwalk  
Index



1/4" System

13/16" System

Fiberglass System

Special Metals

PrimeAngle

Metal Grating

Roofwalk

Index

**A3300 - BEAM LOADING (METRIC)**

Span mm	Max Allowable Uniform Load kN	Defl. at Uniform Load mm	Uniform Loading at Deflection		
			Span/180 kN	Span/240 kN	Span/360 kN
600	1.4	3	1.4	1.2	0.8
750	1.2	5	1.1	0.8	0.5
1,000	0.8	8	0.6	0.4	0.3
1,250	0.7	12	0.4	0.3	0.2
1,500	0.6	18	0.3	0.2	0.1
1,750	0.5	24	0.2	0.1	0.1
2,000	0.4	33	0.1	0.1	0.1

**A3301 - BEAM LOADING (METRIC)**

Span mm	Max Allowable Uniform Load kN	Defl. at Uniform Load mm	Uniform Loading at Deflection		
			Span/180 kN	Span/240 kN	Span/360 kN
600	3.9	2	3.9	3.9	3.9
750	3.1	3	3.1	3.1	2.5
1,000	2.4	5	2.4	2.1	1.4
1,250	1.9	7	1.8	1.3	0.9
1,500	1.6	10	1.2	0.9	0.6
1,750	1.3	14	0.9	0.7	0.4
2,000	1.2	18	0.7	0.5	0.4
2,500	0.9	29	0.4	0.4	0.2
3,000	0.8	43	0.3	0.2	0.1

**A3300 - COLUMN LOADING (METRIC)**

Unbraced Height mm	Maximum Allowable Load at Slot Face kN	Max. Column Load Applied at C.G.			
		K = 0.65 kN	K = 0.80 kN	K = 1.0 kN	K = 1.2 kN
600	6.1	18.3	16.8	14.9	12.2
750	5.8	16.7	14.9	11.5	8.4
1,000	4.9	13.8	10.4	6.8	4.7
1,250	3.9	10.1	6.8	4.3	**
1,500	3.1	7.1	4.7	**	**

**A3301 - COLUMN LOADING (METRIC)**

Unbraced Height mm	Maximum Allowable Load at Slot Face kN	Max. Column Load Applied at C.G.			
		K = 0.65 kN	K = 0.80 kN	K = 1.0 kN	K = 1.2 kN
600	11.2	42.4	41.0	39.0	35.7
750	11.0	40.9	39.0	34.9	30.4
1,000	10.5	37.7	33.4	27.4	21.4
1,250	9.8	33.0	27.4	20.0	14.0
1,500	8.9	28.1	21.4	14.0	9.7
1,750	7.7	23.2	16.1	10.3	**
2,000	6.7	18.6	12.3	7.9	**
2,250	5.8	14.7	9.7	**	**
2,500	5.0	11.9	7.9	**	**

**A3300/A3301 - ELEMENTS OF SECTION (METRIC)**

Parameter	A3300		A3301	
	Value	Unit	Value	Unit
Area of Section	1.48	cm <sup>2</sup>	2.96	cm <sup>2</sup>
Axis 1-1				
Moment of Inertia (I)	0.69	cm <sup>4</sup>	3.22	cm <sup>4</sup>
Section Modulus (S)	0.62	cm <sup>3</sup>	1.69	cm <sup>3</sup>
Radius of Gyration (r)	0.68	cm	1.04	cm
Axis 2-2				
Moment of Inertia (I)	2.17	cm <sup>4</sup>	4.34	cm <sup>4</sup>
Section Modulus (S)	1.37	cm <sup>3</sup>	2.73	cm <sup>3</sup>
Radius of Gyration (r)	1.21	cm	1.21	cm

Notes:

\* Load limited by spot weld shear.

\*\* KL/r > 200

NR = Not Recommended.

1. Beam loads are given in total uniform load (WLbs) not uniform load (w lbs/ft or w lbs/in).
2. Beam loads are based on a simple span and assumed to be adequately laterally braced. Unbraced spans can reduce beam load carrying capacity. Refer to Page 177 for reduction factors for unbraced lengths.
3. Deduct channel weight from the beam loads.
4. For concentrated midspan point loads, multiply beam loads by 50% and the corresponding deflection by 80%. For other load conditions refer to page 18.
5. All beam loads are for bending about Axis 1-1.

BEARING LOADS ON UNISTRUT CHANNEL

Loads are calculated based on 2001 Specification For The Design Of Cold Formed Steel Structural Members published by AISI			
	Bearing Length 1/4" (31.8 mm) Maximum Allowable Loads - Lbs (kN)	Bearing Length 1/4" (31.8 mm) Maximum Allowable Loads - Lbs (kN)	Bearing Length 1/2" (63.5 mm) Maximum Allowable Loads - Lbs (kN)
	A1000 3,700 (16.46)	1,700 (7.56)	4,300 (19.13)
	A3300 3,800 (16.90)	1,700 (7.56)	4,300 (19.13)

CHANNEL NUT WITH SPRING



	Part Number	Nut Size Thread	Wt/100 pcs Lbs (kg)	Use With
	A1006-1420	1/4" -20	6 (2.7)	A1000
	A1007	5/16" -18	6 (2.7)	
	A1008	3/8" -16	6 (2.7)	
	Part Number	Nut Size Thread	Wt/100 pcs Lbs (kg)	Use With
	A4006-1420	1/4" -20	5 (2.3)	A3300
	A4007	5/16" -18	5 (2.3)	
	A4008	3/8" -16	5 (2.3)	

CHANNEL NUT WITHOUT SPRINGS

	Part Number	Nut Size Thread	Wt/100 pcs Lbs (kg)	Use With
	A3006-1420	1/4" -20	5 (2.3)	A1000 or A3300
	A3007	5/16" -18	5 (2.3)	
	A3008	3/8" -16	5 (2.3)	
	Part Number	Nut Size Thread	Wt/100 pcs Lbs (kg)	Use With
	A3016-0832	#8 -32	1 (0.5)	A1000 or A3300
	A3016-1024	#10 -24	1 (0.5)	
	A3016-1032	#10 -32	1 (0.5)	
	A3016-1420	1/4" -20	1 (0.5)	

A1280

END CAP

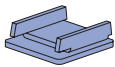

Material: .075" (1.9)  
Note: Use with A1000 channel  
Wt/100 pcs: 7 Lbs (3.2 kg)

A4280

END CAP



Material: .075" (1.9)  
Note: Use with A3300 channel

A1184

CLOSURE STRIP

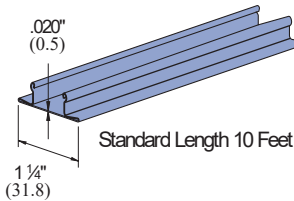

Finish: Perma-Green II (GR), Plain (PL).  
Wt/100 Ft: 21 Lbs (31.3 kg/100M)

A1191

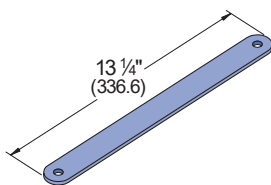

Wt/100 pcs: 87 Lbs (39.5 kg)

A1063

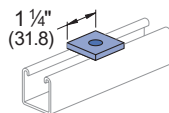

Wt/100 pcs: 8 Lbs (3.6 kg)

A1065

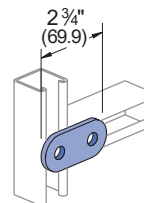

Wt/100 pcs: 17 Lbs (7.7 kg)

A1184P

CLOSURE STRIP

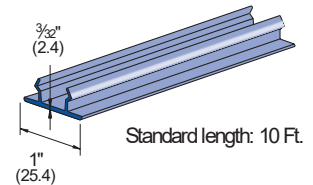

Material: Paintable PVC.  
Color: Green, Grey.

Wt/100 Ft: 21 Lbs (31.3 kg/100M)

Standard Dimensions for 1/4" (31.8 mm) width series channel fittings (Unless Otherwise Shown on Drawing)

Hole Diameter: 13/32" (10.3mm); Hole Spacing - From End: 5/8" (15.9 mm); Hole Spacing - On Center: 1 1/2" (38.1mm); Width: 1/4"(31.8mm); Thickness: 3/16" (4.8mm)



1 1/4" System

1 3/16" System

Fiberglass System

Special Metals

PrimeAngle

Metal Grating

Roofwalk

Index

**A1066**

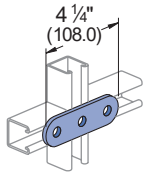

W/100 pcs: 26 Lbs (11.8 kg)

**A2324**

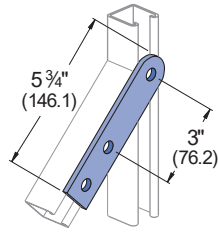

W/100 pcs: 39 Lbs (17.7 kg)

**A1036**

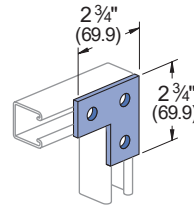

W/100 pcs: 27 Lbs (12.2 kg)

**A1031**

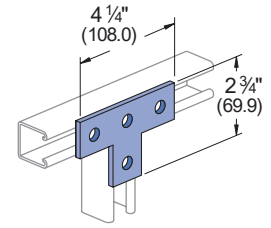

W/100 pcs: 34 Lbs (15.4 kg)

**A1026**

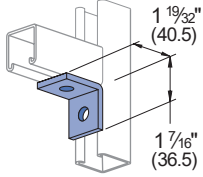

W/100 pcs: 17 Lbs (7.7 kg)

**A1068**

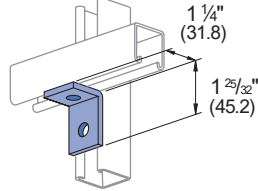

W/100 pcs: 17 Lbs (7.7 kg)



**A1326**

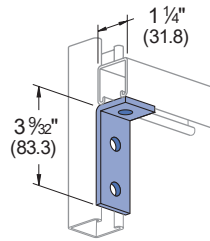

W/100 pcs: 27 Lbs (12.2 kg)

**A1458**

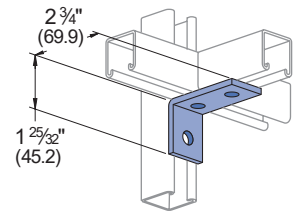

W/100 pcs: 27 Lbs (12.2 kg)

**A1325**

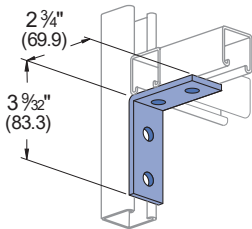

W/100 pcs: 38 Lbs (17.2 kg)

**A2110**

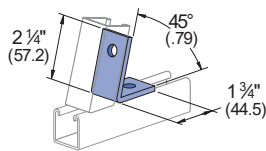

W/100 pcs: 23 Lbs (10.4 kg)

**A2126**

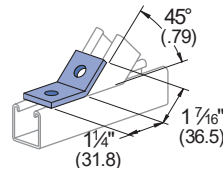

W/100 pcs: 17 Lbs (7.7 kg)

**A2084**

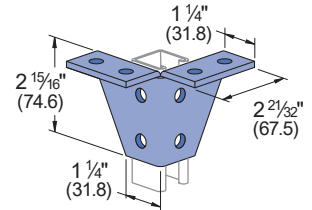

W/100 pcs: 90 Lbs (40.8 kg)

**A2472 R-L**

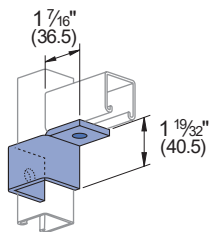

R-As shown  
L-Opposite hand

W/100 pcs: 33 Lbs (15.0 kg)

**A2223**

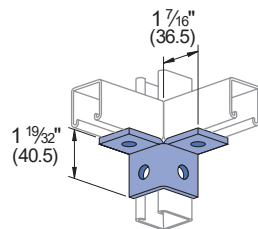

W/100 pcs: 34 Lbs (15.4 kg)

**A2345**

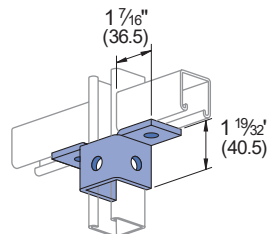

W/100 pcs: 41 Lbs (18.6 kg)

**A2227**

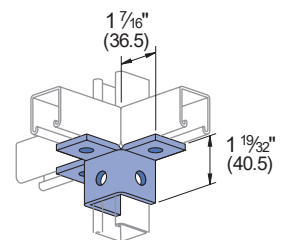

W/100 pcs: 52 Lbs (23.6 kg)

Standard Dimensions for 1/4" (31.8 mm) width series channel fittings (Unless Otherwise Shown on Drawing)

Hole Diameter: 1/32" (10.3mm); Hole Spacing - From End: 5/8" (15.9 mm); Hole Spacing - On Center: 1/2" (38.1mm); Width: 1/4"(31.8mm); Thickness: 3/16" (4.8mm)



**"U" Shape Fittings, Pipe/Tube Clips and Brackets**

**A1047**

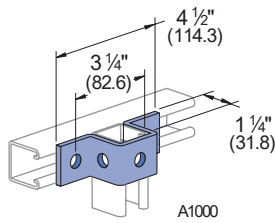

W/100 pcs: 43 Lbs (19.5 kg)

**A3347**

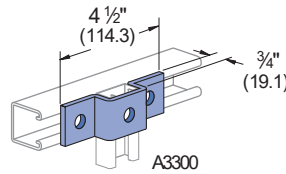

W/100 pcs: 37 Lbs (16.8 kg)

**A2608 THRU A2617**

**UNI-CLIP®**

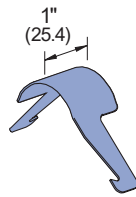
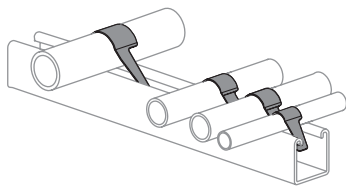

Part Number	Pipe Size In (mm)	O.D. Size In (mm)	W/100 pcs Lbs (kg)
A2608	1/4 (6.4)	0.540 (13.7)	0.6 (0.3)
A2609	3/8 (9.5)	0.675 (17.1)	0.7 (0.3)
A2611	1/2 (12.7)	0.840 (21.3)	1.0 (0.5)
A2612	3/4 (19.1)	1.050 (26.7)	1.4 (0.6)
A2613	1 (25.4)	1.35 (33.4)	2.0 (0.9)
A2614	1 1/4 (31.8)	1.660 (42.2)	2.4 (1.1)
A2615	1 1/2 (38.1)	1.900 (48.3)	3.2 (1.5)
A2617	2 (50.8)	2.375 (60.3)	4.7 (2.1)

Stainless steel, Type 301.

**A2492 R-L**

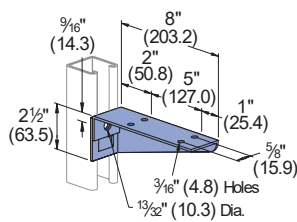

Right

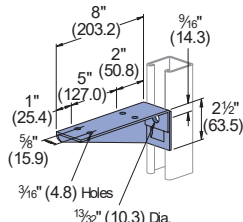

Left

Design Uniform Load  
(Channel Upright Listed)  
A1000 200 Lbs (.89 kN)  
A3300 130 Lbs (.58 kN)  
Safety Factor of 2 1/2

Material: 14 Gauge Steel.

W/100 pcs: 56 Lbs (25.4 kg)

**A2494 R-L**

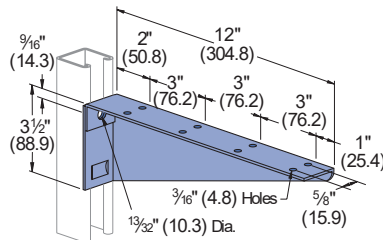

Right

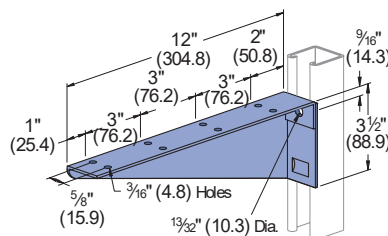

Left

Design Uniform Load  
(Channel Upright Listed)  
A1000 200 Lbs (.89 kN)  
A3300 130 Lbs (.58 kN)  
Safety Factor of 2 1/2

Material: 14 Gauge Steel.

W/100 pcs: 94 Lbs (42.6 kg)

Standard Dimensions for 1 1/4" (31.8 mm) width series channel fittings (Unless Otherwise Shown on Drawing)  
Hole Diameter: 1 3/32" (10.3mm); Hole Spacing - From End: 5/8" (15.9mm); Hole Spacing - On Center: 1 1/2" (38.1mm); Width: 1 1/4" (31.8mm); Thickness: 3/16" (4.8mm)

# 1<sup>3</sup>/<sub>16</sub>" FRAMING SYSTEM

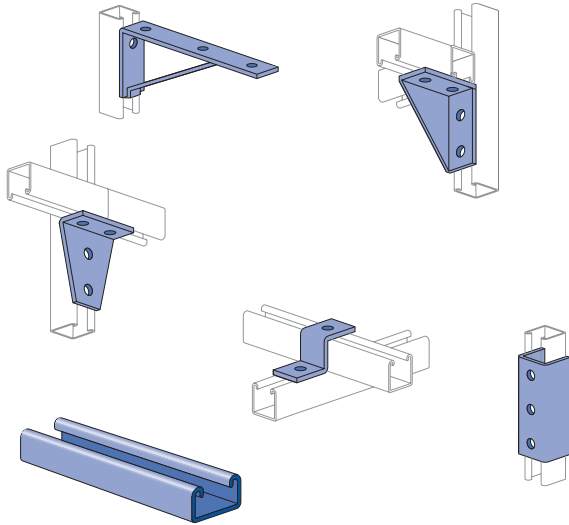

P6000 (19 Gauge) .....	179-181
P7000 (19 Gauge) .....	182-183
Channel Nuts, End Caps, and Closure Strips .....	184
Flat Plate Fittings .....	184-185
Ninety Degree Fittings.....	185
Angular Fittings, Wing Shape Fittings .....	186
"Z" Shape Fittings.....	186
"U" Shape Fittings .....	186-187
Special Application Fittings.....	187
Beam Clamps.....	187
Tubing Clips.....	187

## MATERIAL

Channels are accurately and carefully cold formed to size from low-carbon strip steel.

### STEEL: PLAIN

19 Gauge (1.0 mm) ASTM A1008

### STEEL: PRE-GALVANIZED

19 Gauge (1.0 mm) ASTM A653 GR 33

All nuts are manufactured from mild steel bars conforming to ASTM A1011 SS Grade 33.

Fittings are made from hot rolled, pickled and oiled steel plate or strip and conform to ASTM A1011 SS GR 33.

## FINISHES

Channels are available in: Perma-Green III (GR), electro-galvanized (EG), Pre-galvanized (PG), conforming to ASTM A653 GR 33 and plain (PL).

Nuts are available in plain or electro-galvanized (EG) finish.

Fittings are available in Perma-Green III, electrogalvanized (EG) with zinc electrolytically to commercial standards ASTM B653-G90 Type III SC1; or plain (PL).

## STANDARD LENGTHS

P-6000 – 16 Feet (4.88m)

P-7000 – 10 Feet (3.05m)

Tolerances are +1/8" (3.2 mm) to +1/2" (12.7 mm) to allow for cutting. Special lengths are available for a small cutting charge with a tolerance of ±1/8" (3.2mm).

## APPLICATION

A unique half-size reduction of the 1<sup>5</sup>/<sub>8</sub>" channel width series, this smaller channel size can be used to carry light loads economically in applications such as instrumentation, retail displays and light-duty laboratory supports. It also provides the flexibility found in all Unistrut® framing systems.

## DESIGN BOLT TORQUE

BOLT SIZE	1/4"-20	Rec. Torque Ft/Lbs (N•m)	6 (8)	Max Torque Ft/Lbs (N•m)	7 (9)
-----------	---------	--------------------------	-------	-------------------------	-------

## DIMENSIONS

Imperial dimensions are illustrated in inches. Metric dimensions are shown in parenthesis or as noted. Unless noted, all metric dimensions are in millimeters and rounded to one decimal place.

## LOAD DATA

All beam and column load data pertains to carbon steel and stainless steel channels. Load tables and charts are constructed to be in accordance with the SPECIFICATION FOR THE DESIGN OF COLD-FORMED STEEL STRUCTURAL MEMBERS 2007 EDITION published by the AMERICAN IRON AND STEEL INSTITUTE USING ASD METHOD. Loads are based on 33 ksi steel cold formed to 42 ksi.

Type of Load	Safety Factor to Yield Strength	Safety Factor to Ultimate Strength
Beam Loads	1.67	2.0
Column Load	1.80	2.2

**P6000 Series**

**P7000 Series**

13/16" x 13/16"  
19 Ga.



P6000 - Pg 180



P6001 - Pg 180



P6001 A - Pg 181



P6001 B - Pg 181



P6001 C - Pg 181

13/16" x 13/32"  
19 Ga.

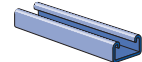

P7000 - Pg 182

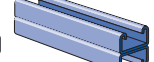

P7001 - Pg 182

**Channel Nuts & Closures**

**13/16" Series Fittings**



P6006-0832 - Pg 184



P7006-0832 - Pg 184



P6280 - Pg 184



P7280 - Pg 184

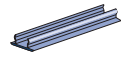

P6184P - Pg 184



P6062 - Pg 184



P6065 - Pg 184



P6924 - Pg 184

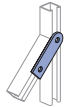

P7325 - Pg 184

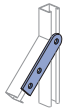

P7324 - Pg 184



P6925 - Pg 184



P6066 - Pg 184



P6067 - Pg 184



P6962 - Pg 184



P6356 A - Pg 184



P6358 A - Pg 184



P6726 A - Pg 184



P6334 - Pg 184



P6380 - Pg 184



P6036 - Pg 184



P6380 A - Pg 184



P6031 - Pg 185



P6028 - Pg 185



P6026 - Pg 185



P6068 - Pg 185



P6281 - Pg 185



P6069 - Pg 185



P6326 - Pg 185



P6346 - Pg 185



P6458 - Pg 185



P6325 - Pg 185



P6357 - Pg 185



P6359 - Pg 185



P6579 - Pg 185



P7235 - Pg 185



P6887 - Pg 185



P6331 - Pg 185



P6332 - Pg 186



P6546 - Pg 186

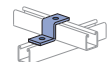

P6045 - Pg 186



P6186 - Pg 186



P6454 - Pg 186



P7045 - Pg 186



P6453 - Pg 186



P6047 - Pg 186



P6737 - Pg 186



P6048 - Pg 186



P6376 - Pg 186



P7376 - Pg 186



P6376 A - Pg 186



P7376 A - Pg 186



P6377 - Pg 186



P7377 - Pg 186



P6455 - Pg 187



P6973 - Pg 187



P6349 - Pg 187



P6353 - Pg 187



P6127 - Pg 187



P6386 - Pg 187



P6379 S - Pg 187

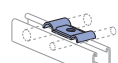

P6805 - Pg 187



P7008 - Pg 187

1/4" System

13/16" System

Fiberglass System

Special Metals

PrimeAngle

Metal Grating

Roofwalk

Index



**P6000 & P6001 Channel**

**P6000 - BEAM LOADING (METRIC)**

Span mm	Max Allowable Uniform Load kN	Defl. at Uniform Load mm	Uniform Loading at Deflection		
			Span/180 kN	Span/240 kN	Span/360 kN
300	1.5	1	1.5	1.5	1.5
450	1.0	2	1.0	1.0	0.8
600	0.8	3	0.8	0.7	0.5
750	0.6	4	0.6	0.4	0.3
1,000	0.4	7	0.4	0.3	0.2
1,250	0.4	11	0.2	0.2	0.1
1,500	0.3	17	0.1	0.1	0.1
1,750	0.3	24	0.1	0.1	0.0

**P6001 - BEAM LOADING (METRIC)**

Span mm	Max Allowable Uniform Load kN	Defl. at Uniform Load mm	Uniform Loading at Deflection		
			Span/180 kN	Span/240 kN	Span/360 kN
300	2.9*	0	2.9*	2.9*	2.9*
450	2.8	1	2.8	2.8	2.8
600	2.1	2	2.1	2.1	2.1
750	1.7	2	1.7	1.7	1.5
1,000	1.2	4	1.2	1.2	0.8
1,250	1.0	7	1.0	0.8	0.5
1,500	0.8	10	0.7	0.5	0.4
1,750	0.7	13	0.5	0.4	0.3
2,000	0.6	17	0.4	0.3	0.2

**P6000 - COLUMN LOADING (METRIC)**

Unbraced Height mm	Maximum Allowable Load at Slot Face kN	Maximum Column Load Applied at C.G.			
		K = 0.65 kN	K = 0.80 kN	K = 1.0 kN	K = 1.2 kN
300	3.1	9.2	8.4	7.3	6.3
450	2.7	7.5	6.3	5.0	3.9
600	2.2	5.9	4.6	3.4	2.7
750	1.8	4.5	3.4	2.5	2.0
1,000	1.4	3.0	2.4	1.8	1.5
1,250	1.1	2.3	1.8	1.4	1.2
1,500	0.9	1.9	1.5	1.2	**
1,750	0.8	1.6	1.2	**	**

**P6001 - COLUMN LOADING (METRIC)**

Unbraced Height mm	Maximum Allowable Load at Slot Face kN	Maximum Column Load Applied at C.G.			
		K = 0.65 kN	K = 0.80 kN	K = 1.0 kN	K = 1.2 kN
300	5.5	20.7	20.1	19.2	18.2
450	5.4	19.3	18.2	16.9	15.7
600	5.2	17.8	16.5	14.9	13.7
750	5.0	16.4	14.9	13.5	11.2
1,000	4.6	14.4	12.9	9.5	6.7
1,250	3.9	12.7	9.5	6.2	4.3
1,500	3.2	9.9	6.7	4.3	**
1,750	2.6	7.5	4.9	**	**
2,000	2.2	5.7	3.8	**	**

**P6000 & P6001 - ELEMENTS OF SECTION (METRIC)**

Parameter	P6000	P6001
Area of Section	0.69 cm <sup>2</sup>	1.38 cm <sup>2</sup>
Axis 1-1		
Moment of Inertia (I)	0.39 cm <sup>4</sup>	1.88 cm <sup>4</sup>
Section Modulus (S)	0.33 cm <sup>3</sup>	0.91 cm <sup>3</sup>
Radius of Gyration (r)	0.75 cm	1.17 cm
Axis 2-2		
Moment of Inertia (I)	0.49 cm <sup>4</sup>	0.99 cm <sup>4</sup>
Section Modulus (S)	0.48 cm <sup>3</sup>	0.96 cm <sup>3</sup>
Radius of Gyration (r)	0.85 cm	0.85 cm

Notes:

\* Load limited by spot weld shear.

\*\* KL/r > 200

NR = Not Recommended.

1. Beam loads are given in total uniform load (Wlbs) not uniform load (w lbs/ft or w lbs/in).
2. Beam loads are based on a simple span and assumed to be adequately laterally braced. Unbraced spans can reduce beam load carrying capacity. Refer to Page 186 for reduction factors for unbraced lengths.
3. Deduct channel weight from the beam loads.
4. For concentrated midspan point loads, multiply beam loads by 50% and the corresponding deflection by 80%. For other load conditions refer to page 18.
5. All beam loads are for bending about Axis 1-1.

**P6001A**

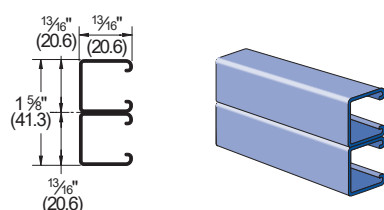

W/100 Ft: 73 Lbs (108 kg/100 m)  
Allowable Moment 1,820 In-Lbs (210 N•m)  
19 Gauge Nominal Thickness .040" (1.0 mm)

**P6001B**

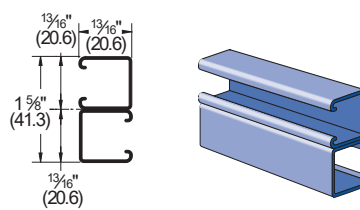

W/100 Ft: 73 Lbs (108 kg/100 m)  
Allowable Moment 1,820 In-Lbs (210 N•m)  
19 Gauge Nominal Thickness .040" (1.0 mm)

**P6001C**

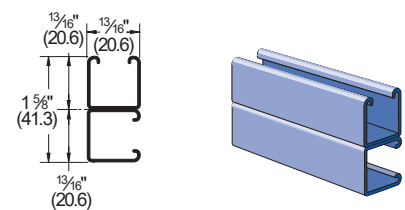

W/100 Ft: 73 Lbs (108 kg/100 m)  
Allowable Moment 1,550 In-Lbs (180 N•m)  
19 Gauge Nominal Thickness .040" (1.0 mm)



**P7000**

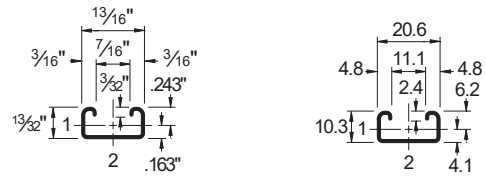
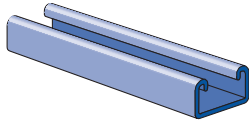

WW/100 Ft: 25 Lbs (38 kg/100m)  
Allowable Moment 170 In-Lbs (20 N•m)  
19 Gauge Nominal Thickness .040" (1.0 mm)

**P7001**

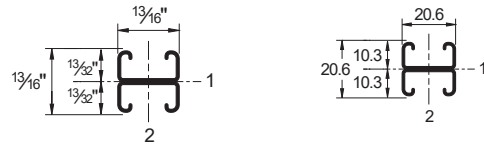
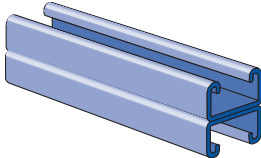

WW/100 Ft: 50 Lbs (75 kg/100m)  
Allowable Moment 450 In-Lbs (50 N•m)  
19 Gauge Nominal Thickness .040" (1.0 mm)

**P7000 - BEAM LOADING**

Span In	Max Allowable Uniform Load Lbs	Defl. at Uniform Load In	Uniform Loading at Deflection		
			Span/180 Lbs	Span/240 Lbs	Span/360 Lbs
18	80	0.12	60	50	30
24	60	0.22	40	30	20
30	50	0.36	20	20	10
36	40	0.50	20	10	10

**P7001 - BEAM LOADING**

Span In	Max Allowable Uniform Load Lbs	Defl. at Uniform Load In	Uniform Loading at Deflection		
			Span/180 Lbs	Span/240 Lbs	Span/360 Lbs
18	200	0.07	200	200	140
24	150	0.12	150	120	80
30	120	0.19	100	80	50
36	100	0.28	70	50	40
42	90	0.40	50	40	30
48	80	0.53	40	30	20

**P7000 - COLUMN LOADING**

Unbraced Height In	Maximum Allowable Load at Slot Face Lbs	Maximum Column Load Applied at C.G.			
		K = 0.65 Lbs	K = 0.80 Lbs	K = 1.0 Lbs	K = 1.2 Lbs
18	420	1,200	990	720	510
24	330	900	640	410	280
30	260	620	410	**	**
36	200	430	280	**	**

**P7001 - COLUMN LOADING**

Unbraced Height In	Maximum Allowable Load at Slot Face Lbs	Maximum Column Load Applied at C.G.			
		K = 0.65 Lbs	K = 0.80 Lbs	K = 1.0 Lbs	K = 1.2 Lbs
18	790	2,930	2,690	2,330	1,960
24	740	2,570	2,210	1,720	1,260
30	680	2,180	1,720	1,160	800
36	580	1,780	1,260	800	560
42	500	1,400	920	590	**
48	420	1,070	710	**	**
54	360	850	560	**	**

**P7000 & P7001 - ELEMENTS OF SECTION**

Parameter	P7000		P7001	
Area of Section	0.074	In <sup>2</sup>	0.148	In <sup>2</sup>
Axis 1-1				
Moment of Inertia (I)	0.002	In <sup>4</sup>	0.007	In <sup>4</sup>
Section Modulus (S)	0.007	In <sup>3</sup>	0.018	In <sup>3</sup>
Radius of Gyration (r)	0.150	In	0.222	In
Axis 2-2				
Moment of Inertia (I)	0.007	In <sup>4</sup>	0.014	In <sup>4</sup>
Section Modulus (S)	0.017	In <sup>3</sup>	0.034	In <sup>3</sup>
Radius of Gyration (r)	0.307	In	0.307	In

Notes:

\* Load limited by spot weld shear.

\*\* KL/r > 200

NR = Not Recommended.

1. Beam loads are given in total uniform load (WLbs) not uniform load (w lbs/ft or w lbs/in).
2. Beam loads are based on a simple span and assumed to be adequately laterally braced. Unbraced spans can reduce beam load carrying capacity. Refer to Page 186 for reduction factors for unbraced lengths.
3. Deduct channel weight from the beam loads.
4. For concentrated midspan point loads, multiply beam loads by 50% and the corresponding deflection by 80%. For other load conditions refer to page 18.
5. All beam loads are for bending about Axis 1-1.

**P7000 & P7001 Channel**

**P7000 - BEAM LOADING (METRIC)**

Span mm	Max Allowable Uniform Load kN	Defl. at Uniform Load mm	Uniform Loading at Deflection		
			Span/180 kN	Span/240 kN	Span/360 kN
300	0.5	1	0.5	0.5	0.4
450	0.4	3	0.3	0.2	0.1
600	0.3	5	0.2	0.1	0.1
750	0.2	9	0.1	0.1	0.0
1,000	0.2	16	0.0	0.0	0.0
1,250	0.1	24	0.0	0.0	NR
1,500	0.1	28	0.0	NR	NR

**P7001 - BEAM LOADING (METRIC)**

Span mm	Max Allowable Uniform Load kN	Defl. at Uniform Load mm	Uniform Loading at Deflection		
			Span/180 kN	Span/240 kN	Span/360 kN
300	1.4	1	1.4	1.4	1.4
450	0.9	2	0.9	0.9	0.7
600	0.7	3	0.7	0.5	0.4
750	0.5	5	0.5	0.4	0.2
1,000	0.4	8	0.3	0.2	0.1
1,250	0.3	13	0.2	0.1	0.1
1,500	0.3	19	0.1	0.1	NR

**P7000 - COLUMN LOADING (METRIC)**

Unbraced Height mm	Maximum Allowable Load at Slot Face kN	Maximum Column Load Applied at C.G.			
		K = 0.65 kN	K = 0.80 kN	K = 1.0 kN	K = 1.2 kN
300	2.1	6.4	6.0	5.3	4.5
450	1.9	5.4	4.5	3.3	2.3
600	1.5	4.1	2.9	1.9	1.3
750	1.2	2.8	1.9	1.2	**

**P7001 - COLUMN LOADING (METRIC)**

Unbraced Height mm	Maximum Allowable Load at Slot Face kN	Maximum Column Load Applied at C.G.			
		K = 0.65 kN	K = 0.80 kN	K = 1.0 kN	K = 1.2 kN
300	3.6	14.0	13.6	13.0	12.1
450	3.5	13.1	12.1	10.5	8.9
600	3.3	11.6	10.0	7.8	5.8
750	3.0	9.8	7.8	5.3	3.7
1,000	2.4	6.9	4.7	3.0	**
1,250	1.8	4.5	3.0	**	**

**P7000 & P7001 - ELEMENTS OF SECTION (METRIC)**

Parameter	P7000	P7001
Area of Section	0.48 cm <sup>2</sup>	0.96 cm <sup>2</sup>
Axis 1-1		
Moment of Inertia (I)	0.07 cm <sup>4</sup>	0.31 cm <sup>4</sup>
Section Modulus (S)	0.11 cm <sup>3</sup>	0.30 cm <sup>3</sup>
Radius of Gyration (r)	0.38 cm	0.57 cm
Axis 2-2		
Moment of Inertia (I)	0.29 cm <sup>4</sup>	0.58 cm <sup>4</sup>
Section Modulus (S)	0.28 cm <sup>3</sup>	0.56 cm <sup>3</sup>
Radius of Gyration (r)	0.78 cm	0.78 cm

Notes:

\* Load limited by spot weld shear.

\*\* KL/r > 200

NR = Not Recommended.

1. Beam loads are given in total uniform load (W Lbs) not uniform load (w lbs/ft or w lbs/in).
2. Beam loads are based on a simple span and assumed to be adequately laterally braced. Unbraced spans can reduce beam load carrying capacity. Refer to table below for reduction factors for unbraced lengths.
3. Deduct channel weight from the beam loads.
4. For concentrated midspan point loads, multiply beam loads by 50% and the corresponding deflection by 80%. For other load conditions refer to page 18.
5. All beam loads are for bending about Axis 1-1.

**BEARING LOADS ON UNISTRUT CHANNEL**

Channel	Bearing Length 1 <sup>3</sup> / <sub>16</sub> " (20.6 mm) Maximum Allowable Loads - Lbs (kN)	Bearing Length 1 <sup>3</sup> / <sub>16</sub> " (20.6 mm) Maximum Allowable Loads - Lbs (kN)	Bearing Length 1 <sup>1</sup> / <sub>2</sub> " (41.3 mm) Maximum Allowable Loads - Lbs (kN)
P6000	1,000 (4.45)	500 (2.22)	1,200 (5.34)
P7000	1,000 (4.45)	500 (2.22)	1,200 (5.34)

**LATERAL BRACING LOAD REDUCTION CHARTS**

Span In. (cm)	Single Channel		Double Channel	
	P6000	P7000	P6001	P7001
24 (61)	0.80	0.95	0.99	1.00
36 (91)	0.63	0.90	0.89	0.93
48 (122)	0.52	0.87	0.79	0.86
60 (152)	0.45	0.83	0.70	0.80
72 (183)	0.40	0.80	0.60	0.73
84 (213)	0.37	0.76	0.51	0.67
96 (244)	0.34	0.73	0.44	0.60

**MAXIMUM ALLOWABLE PULL-OUT AND SLIP LOADS**

Nut Size/ Thread	Max. Allowable Pull-Out Lbs (kN)	Resistance to Slip Lbs (kN)	Torque Ft-Lbs (Nm)
1/4"-20	250 1.11	150 0.67	6 8

1/4" System

13/16" System

Fiberglass System

Special Metals

PrimeAngle

Metal Grating

Roofwalk

Index



1/4" System

13/16" System

Fiberglass System

Special Metals

PrimeAngle

Metal Grating

Roofwalk

Index

**P6006-0832 THRU P6006-1420**  
**CHANNEL NUT W/SPRING**

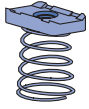

Part Number	Thread Size In	W/100 pcs Lbs (kg)
P6006-0836	#8 - 36	1 (0.5)
P6006-0832	#8 - 32	1 (0.5)
P6006-1032	#10 - 32	1 (0.5)
P6006-1024	#10 - 24	1 (0.5)
P6006-1420	1/4" - 20	1 (0.5)

**P6013-0832 THRU P6006-1420**  
**CHANNEL NUT**

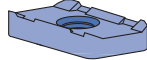

Part Number	Thread Size In	W/100 pcs Lbs (kg)
P6013-0836	#8 - 36	1 (0.5)
P6013-0832	#8 - 32	1 (0.5)
P6013-1032	#10 - 32	1 (0.5)
P6013-1024	#10 - 24	1 (0.5)
P6013-1420	1/4" - 20	1 (0.5)

**P7006-0832 THRU P7006-1420**  
**CHANNEL NUT W/SPRING**



Part Number	Thread Size In	W/100 pcs Lbs (kg)
P7006-0836	#8 - 36	1 (0.5)
P7006-0832	#8 - 32	1 (0.5)
P7006-1032	#10 - 32	1 (0.5)
P7006-1024	#10 - 24	1 (0.5)
P7006-1420	1/4" - 20	1 (0.5)

**P6280 - END CAP FOR P6000**

Material: .060" (1.5)

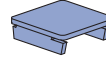

W/100 pcs: 3 Lbs (1.4 kg)

**P6184 P - CLOSURE STRIP**

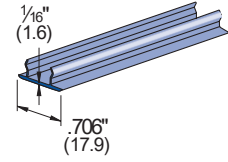

Material: PVC, Plastic.  
Standard Length: 10 Feet (3.05 m).

W/100 Ft: 4 Lbs (6.0 kg/100m)

**P7280 - END CAP FOR P7000**

Material: .048" (1.2)

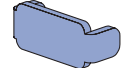

W/100 pcs: 1 Lbs (0.5 kg)

**P6062**

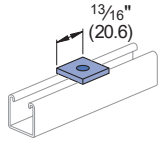

W/100 pcs: 2 Lbs (0.9 kg)

**P6065**

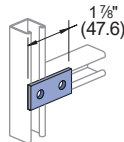

W/100 pcs: 5 Lbs (2.3 kg)

**P6924**

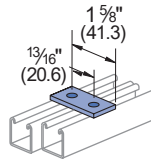

W/100 pcs: 5 Lbs (2.3 kg)

**P7325**

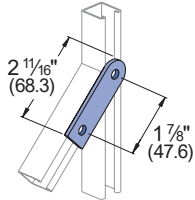

W/100 pcs: 7 Lbs (3.2 kg)

**P7324**

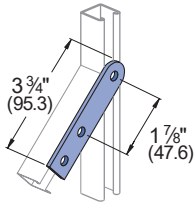

W/100 pcs: 10 Lbs (4.5 kg)

**P6925**

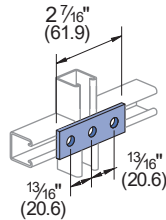

W/100 pcs: 7 Lbs (3.2 kg)

**P6066**

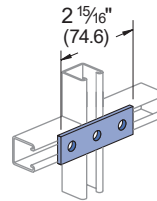

W/100 pcs: 8 Lbs (3.6 kg)

**P6067**

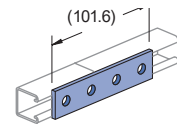

W/100 pcs: 11 Lbs (5.0 kg)

**P6962**

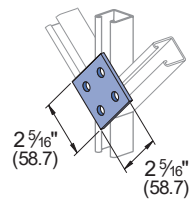

W/100 pcs: 19 Lbs (8.6 kg)

**P6356A**

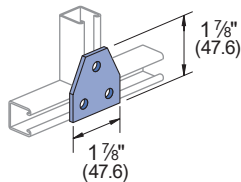

W/100 pcs: 10 Lbs (4.5 kg)

**P6358A**

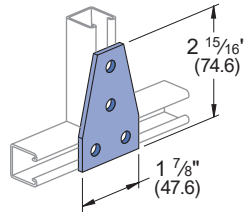

W/100 pcs: 15 Lbs (6.8 kg)

**P6726A**

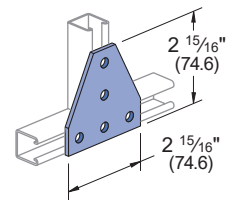

W/100 pcs: 22 Lbs (10.0 kg)

**P6334**

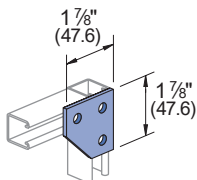

W/100 pcs: 11 Lbs (5.0 kg)

**P6380**

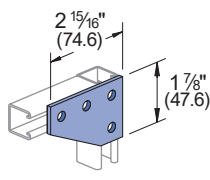

W/100 pcs: 15 Lbs (6.8 kg)

**P6036**

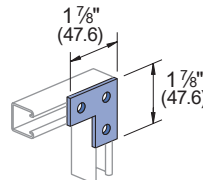

W/100 pcs: 8 Lbs (3.6 kg)

**P6380A**

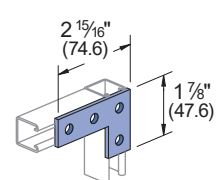

W/100 pcs: 11 Lbs (5.0 kg)

Standard Dimensions for 13/16" (20.6mm) width series channel fittings (Unless Otherwise Shown on Drawing)

Hole Diameter: 5/32" (7.1mm); Hole Spacing - From End: 1 9/32" (10.3mm); Hole Spacing - On Center: 1 1/16" (27.0mm); Width: 13/16" (20.6mm); Thickness: 1/8" (3.2mm)



**Flat and 90° Fittings**

**P6031**

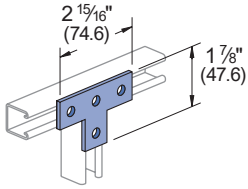

WW/100 pcs: 11 Lbs (5.0 kg)

**P6028**

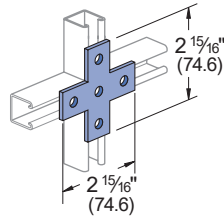

WW/100 pcs: 14 Lbs (6.4 kg)

**P6026**

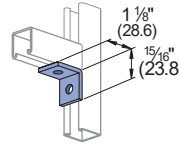

WW/100 pcs: 5 Lbs (2.3 kg)

**P6068**

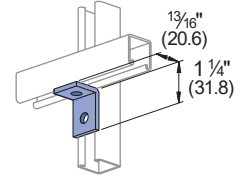

WW/100 pcs: 5 Lbs (2.3 kg)

**P6281 , P6282, P6283**

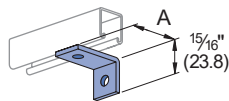

Part Number	A In (mm)	Wt/100 pcs Lbs (kg)
P6281	2	8
P6282	2 1/2	9
P6283	3	10
	76.2	4.5

**P6069**

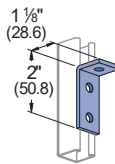

WW/100 pcs: 8 Lbs (3.6 kg)

**P6326**

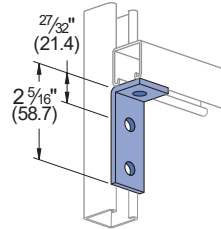

WW/100 pcs: 8 Lbs (3.6 kg)

**P6346**

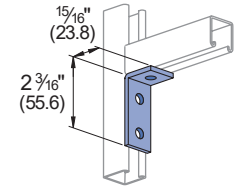

WW/100 pcs: 8 Lbs (3.6 kg)

**P6458**

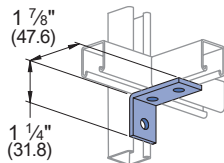

WW/100 pcs: 8 Lbs (3.6 kg)

**P6325**

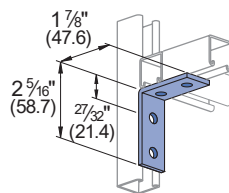

WW/100 pcs: 11 Lbs (5.0 kg)

**P6357**

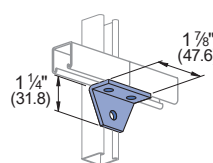

WW/100 pcs: 10 Lbs (4.5 kg)

**P6359**

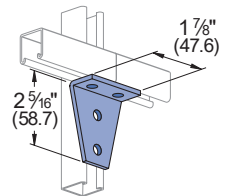

WW/100 pcs: 15 Lbs (6.8 kg)

**P6579**

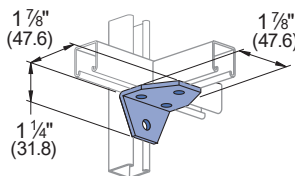

WW/100 pcs: 15 Lbs (6.8 kg)

**P7235**

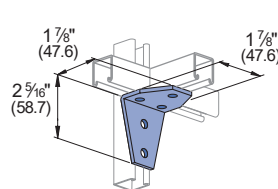

WW/100 pcs: 18 Lbs (8.2 kg)

**P6887**

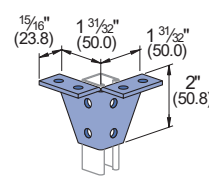

WW/100 pcs: 28 Lbs (12.7 kg)

**P6331**

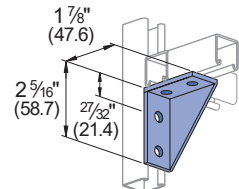

WW/100 pcs: 19 Lbs (8.6 kg)

Standard Dimensions for 1 3/16" (20.6mm) width series channel fittings (Unless Otherwise Shown on Drawing)

Hole Diameter: 5/32" (7.1mm); Hole Spacing - From End: 1 3/32" (10.3mm); Hole Spacing - On Center: 1 1/16" (27.0mm); Width: 1 3/16" (20.6mm); Thickness: 1/8" (3.2mm)



1/4" System

13/16" System

Fiberglass System

Special Metals

PrimeAngle

Metal Grating

Roofwalk

Index

**P6332**

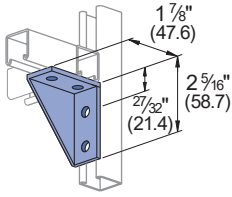

W/100 pcs: 19 Lbs (8.6 kg)

**P6546**

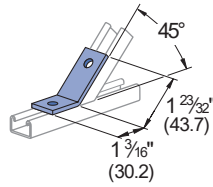

W/100 pcs: 8 Lbs (3.6 kg)

**P6045**

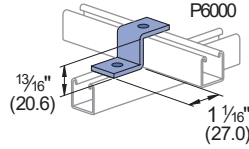

W/100 pcs: 7 Lbs (3.2 kg)

**P6186**

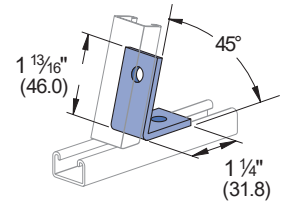

W/100 pcs: 8 Lbs (3.6 kg)

**P6454**

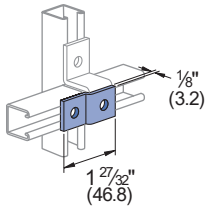

W/100 pcs: 5 Lbs (2.3 kg)

**P7045**

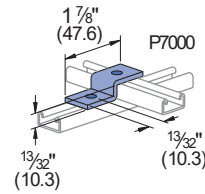

W/100 pcs: 6 Lbs (2.7 kg)

**P6453**

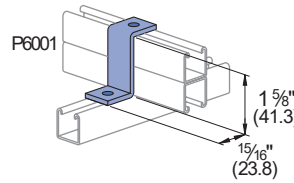

W/100 pcs: 9 Lbs (4.1 kg)

**P6047, P7047**

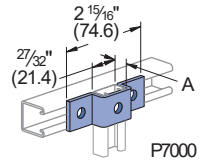

Part No.	A In (mm)	W/100 pcs Lbs (kg)	Use with Channel
P6047	1 9/16 20.6	12 5.4	P6000
P7047	1 3/32 10.3	10 4.5	P7000

**P6737**

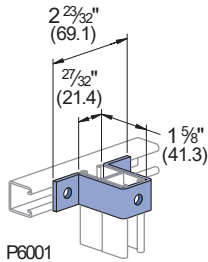

W/100 pcs: 16 Lbs (7.3 kg)

**P6048**

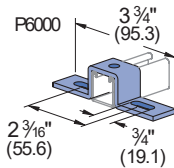

W/100 pcs: 14 Lbs (6.4 kg)

**P6376**

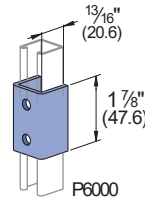

W/100 pcs: 17 Lbs (7.7 kg)

**P7376**

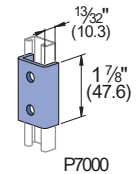

W/100 pcs: 11 Lbs (5.0 kg)

**P6376A**

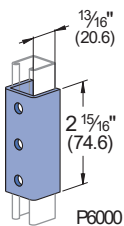

W/100 pcs: 26 Lbs (11.8 kg)

**P7376A**

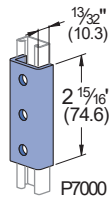

W/100 pcs: 16 Lbs (7.3 kg)

**P6377**

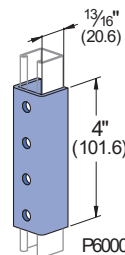

W/100 pcs: 36 Lbs (16.3 kg)

**P7377**

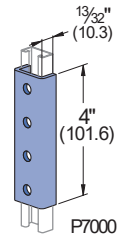

W/100 pcs: 24 Lbs (10.9 kg)

Standard Dimensions for 13/16" (20.6mm) width series channel fittings (Unless Otherwise Shown on Drawing)

Hole Diameter: 5/32" (7.1mm); Hole Spacing - From End: 13/32" (10.3mm); Hole Spacing - On Center: 1 1/16" (27.0mm); Width: 13/16" (20.6mm); Thickness: 1/8" (3.2mm)

**"U" Shape Fittings, Beam Clamps, Slides, Brackets, and Tubing Clips**

**P6455**

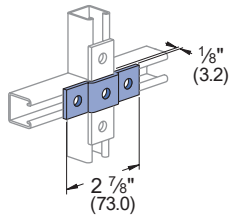

W/100 pcs: 8 Lbs (3.6 kg)

**P6973**

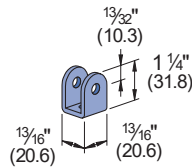

W/100 pcs: 8 Lbs (3.6 kg)

**P6349**

**ACETAL SLIDE**

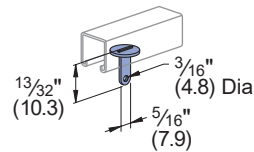

W/100 pcs: 1 Lbs (0.5 kg)

**P6353**

**ACETAL SLIDE**

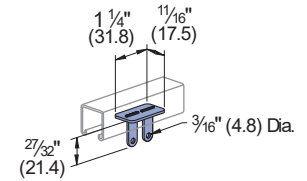

W/100 pcs: 1 Lbs (0.5 kg)

**P6127 - P6129**

**BRACKET**

**P6386**

**BEAM CLAMP**

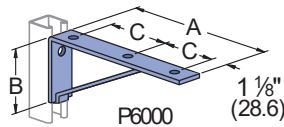

Part No.	Uniform Design Load Lbs (kN)	"A" In (mm)	"B" In (mm)	"C" In (mm)	W/100 pcs Lbs (kg)
P6127	150 0.67	6 1/2 165.1	2 1/2 63.5	2 1/2 63.5	30 13.6
P6128	150 0.67	8 1/2 215.9	3 1/4 82.6	3 1/2 88.9	40 18.1
P6129	130.0 0.58	10 1/2 266.7	4 101.6	4 1/2 114.3	50 22.7

Safety Factor 2 1/2

W/100 pcs: 4 Lbs (1.8 kg)

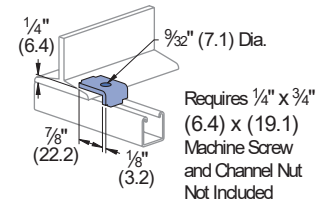

Requires 1/4" x 3/4" (6.4) x (19.1) Machine Screw and Channel Nut Not Included

Use in pairs.

**P6379 S**

**BEAM CLAMP**

**P6805 THRU P6810**

**TUBING CLIPS**

Use in pairs.

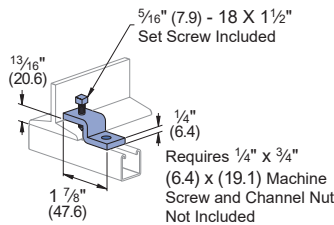

W/100 pcs: 13 Lbs (5.9 kg)

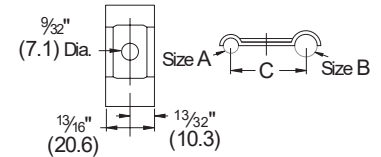
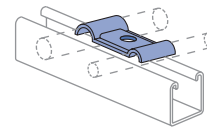

**P7008 THRU P7020**

**TUBING CLIPS**

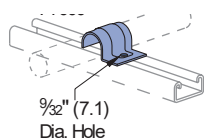

Part Number	O.D. Tube Size "A" In (mm)	W/100 pcs Lbs (kg)
P7008	1/4 6.4	1 0.45
P7009	5/16 7.9	1 0.45
P7010	3/8 9.5	2 0.91
P7012	1/2 12.7	2 0.91
P7014	5/8 15.9	3 1.4
P7016	3/4 19.1	4 1.8
P7018	7/8 22.2	5 2.3
P7020	1 25.4	5 2.3

Material: 16 Gauge (1.5)

Part Number	O.D. Tube Size "A" In (mm)	O.D. Tube Size "B" In (mm)	"C" In (mm)	W/100 pcs Lbs (kg)
P6805	1/4 6.4	1/4 6.4	3/4 19.1	1 0.5
P6806	3/8 9.5	3/8 9.5	1 25.4	2 0.9
P6807	1/2 12.7	1/2 12.7	1 1/4 31.8	3 1.4
P6808	1/4 6.4	3/8 9.5	7/8 22.2	2 0.9
P6809	1/4 6.4	1/2 12.7	1 25.4	2 0.9
P6810	3/8 9.5	1/2 12.7	1 1/8 28.6	3 1.4

Standard Dimensions for 13/16" (20.6mm) width series channel fittings (Unless Otherwise Shown on Drawing)

Hole Diameter: 9/32" (7.1mm); Hole Spacing - From End: 13/32" (10.3mm); Hole Spacing - On Center: 1 1/8" (27.0mm); Width: 13/16" (20.6mm); Thickness: 1/8" (3.2mm)

1/4" System  
1 3/16" System  
Fiberglass System  
Special Metals  
PrimeAngle  
Metal Grating  
Roofwalk  
Index

# FIBERGLASS SYSTEM

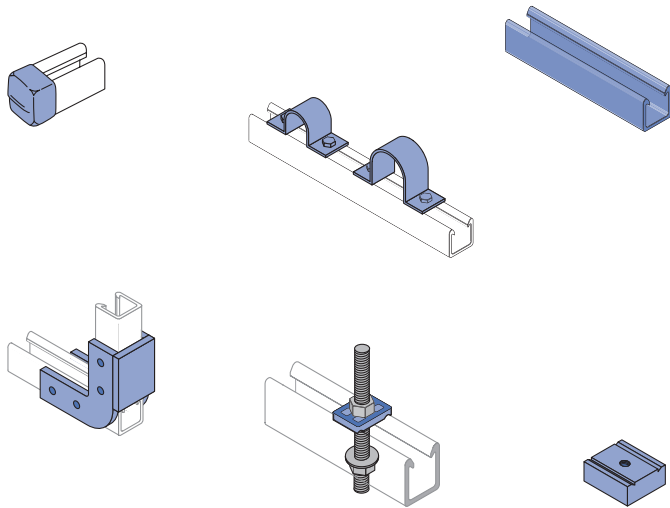

Heavy Duty Channel (Flange Profile) .....	190
Light Duty Channel (Flange Profile) .....	191
Heavy Duty Channel (SST Profile).....	192
Nuts & Hardware .....	193 - 195
Fittings.....	196 - 197
Pipe Clamps.....	198
Clevis Hangers and Channel Inserts .....	199
Beam Clamps.....	200
Power Rack Stanchions .....	200
Chemical Compatibility .....	201 - 202
Specifications .....	203

## POLYESTER AND VINYL ESTER MATERIALS

Polyester and vinyl ester channels are manufactured from the pultrusion process and are color coded gray and beige respectively. Components are made by reinforcing a polymer resin (polyester or vinyl ester) with multiple strands of glass filament, alternating layers of glass mat and U.V. resistant surfacing veils. The glass is drawn through the liquid resin, which coats and saturates the fibers. The combination of resin, glass and veil is then continuously guided and pulled (pultruded) through a heated die that determines the shape of the component.

In the die, the resin is cured to form a reinforced part which can be cut to length. The hardened fiberglass pultrusion is reinforced with an internal arrangement of permanently bonded continuous glass fibers to increase its strength.

## INSTALLATION

Fabrication requires just three simple operations: cutting, drilling and sealing as described below.

**Cutting** – Hand held saws, such as hack saws (24 to 32 teeth per inch) are suitable when a few cuts are required. For frequent cutting, a circular power saw with a carbide-tipped masonry blade yields the best results. When using a power saw, dust filter masks, gloves and long sleeve clothing should be worn.

**Drilling** – Any standard twist bit, even when used with battery-powered drills will work well. Carbide-tipped drill bits are recommended.

**Sealing** – To protect against future migration of corrosive elements into the cut sections, all cuts and holes should be properly sealed with clear urethane sealer.

## OPERATING ENVIRONMENT

**Temperature Ranges** – Fiberglass parts are supplied in five different materials covering distinct temperature ranges. The temperature ranges indicated are meant to be used only as a general guideline. Continual exposure to elevated temperatures reduces the strength properties of plastics and glass-reinforced fiberglass. Actual resin test data confirms that a 50% reduction in strength occurs at the extreme high temperature levels.

**Chemical Resistance** – See the chart on page 204-205 for corrosion resistance. The results are based upon immersion for a 24 hour period. This is typically the “worst case” exposure to corrosion. Less severe contact such as spills, splashes and vapor condensate will exceed the performance results listed in the table.

**Loading** – Channel loading is defined with description of each type of channel. Additional loading and design limitations for fittings and accessories are described in the appropriate section for that part.

Material Temperature Ratings		
Material Code	Low Temp.	High Temp.
E - (Rigid PVC)	-25°F (-31°C)	130°F (54°C)
P - (Poly/Glass)	-35°F (-37°C)	200°F (93°C)
V - (Vinyl/Glass)	-35°F (-37°C)	200°F (93°C)
PU - (Poly)	-40°F (-40°C)	140°F (60°C)
N - (Nylon)	-20°F (-29°C)	150°F (66°C)

**Fiberglass Pictorial Index**

**Channel - Aickinstrut Flange Profile**

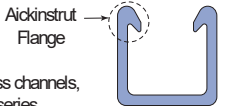

Aickinstrut Flange

Unistrut fiberglass channels, except the SST series, incorporate the Aickinstrut flange design which provides reliable fastening and interlocking of components and accessories. It is important to note that standard metal framing components such as pipe clamps and strut nuts will not work with the flange design.

**Heavy Duty Aickinstrut Flange Profile**  
1 5/8" x 1 5/8"

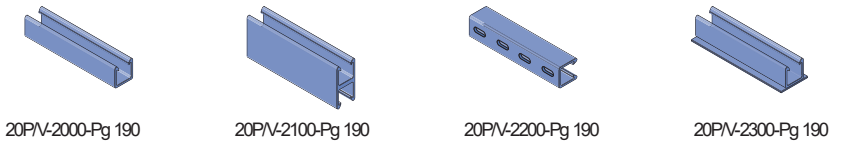

**Light Duty Aickinstrut Flange Profile**  
1 1/2" x 1 1/8"

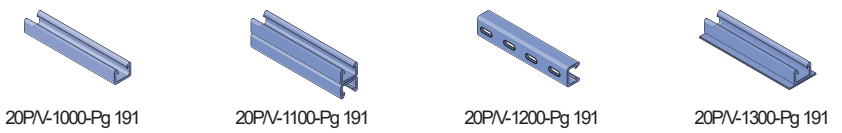

**Channel - SST Profile**

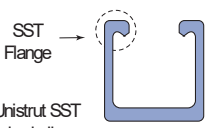

SST Flange

The Unistrut SST profile is similar to the profile of standard metal channel. The Unistrut SST profile will accommodate standard 1 5/8" metal channel fittings and components. This profile is available in polyester or vinyl ester resin. The Unistrut SST profile is not compatible with the fiberglass pipe clamps and channel nuts shown in this section. Typically, stainless steel clamps and strut nuts (listed elsewhere in this catalog) are used with this profile.

**Heavy Duty SST Profile**  
1 5/8" x 1 5/8"

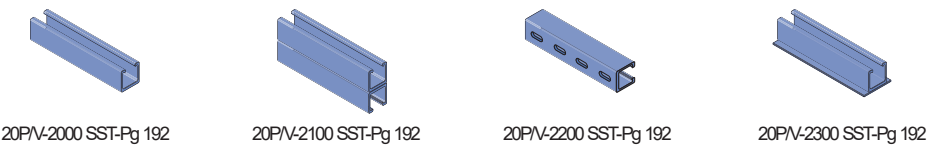

**Hardware & Accessories**

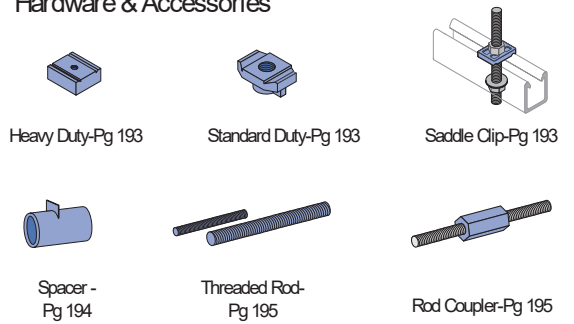

**Fittings**

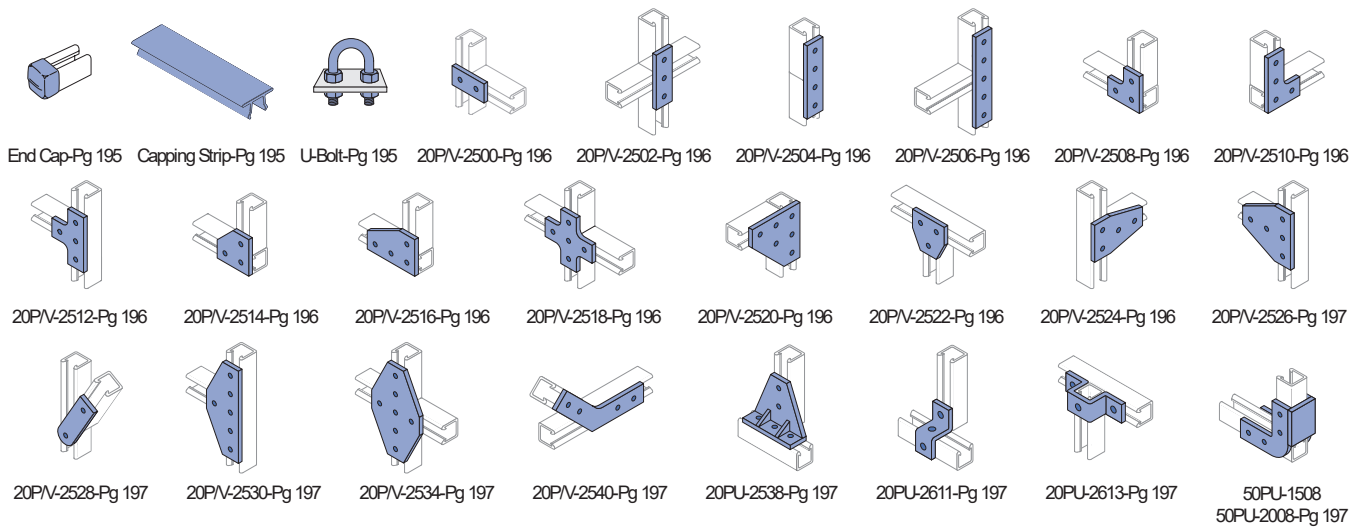

**Pipe Clamps, Beam Clamps and Stanchions**

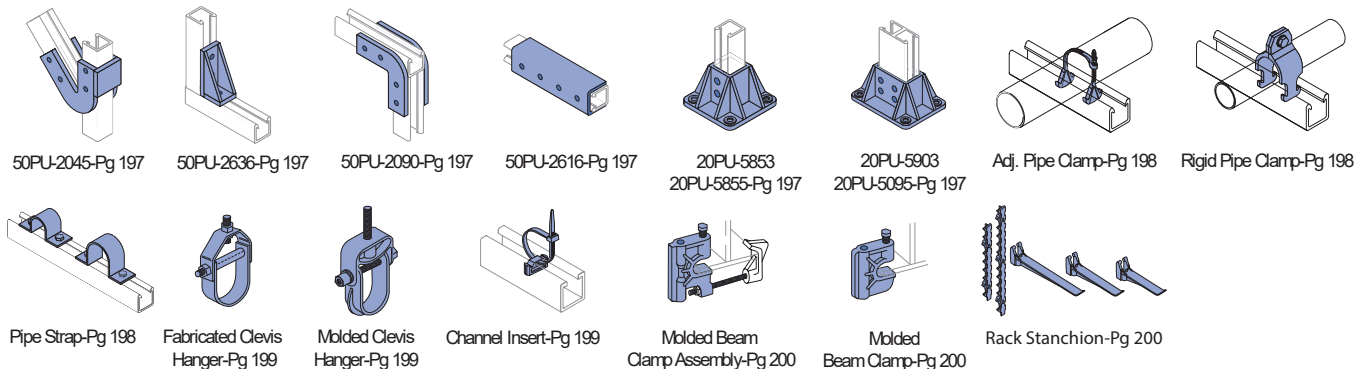



1 1/4" System

1 3/16" System

Fiberglass System

Special Metals

PrimeAngle

Metal Grating

Roofwalk

Index

**20P-2000, 20V-2000**

**HEAVY DUTY SINGLE CHANNEL - AICKINSTRUT FLANGE PROFILE**

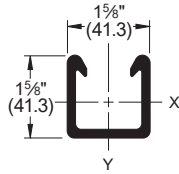
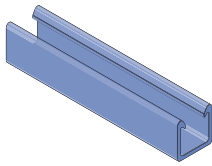

W/100 Ft: 82 Lbs (122 kg/100 m)

**20P-2100, 20V-2100**

**HEAVY DUTY BACK-TO-BACK CHANNEL - AICKINSTRUT FLANGE PROFILE**

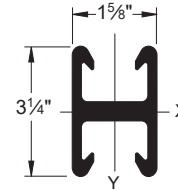
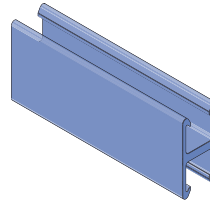

W/100 Ft: 164 Lbs (244 kg/100 m)

**SECTION PROPERTIES**

Part Number	Weight lbs./ft. (kg/m)	Area in <sup>2</sup> (mm <sup>2</sup> )	X - X Axis			Y - Y Axis			
			I in <sup>4</sup> (mm <sup>4</sup> )	R In (mm)	C1 In (mm)	C2 In (mm)	I in <sup>4</sup> (mm <sup>4</sup> )	R In (mm)	C In (mm)
20P-2000,	0.82	1.06	0.31	0.54	0.7	0.93	0.42	0.63	0.82
20V-2000	1.2	6.8	12.9	13.7	17.8	23.622	17.5	16.0	20.8
20P-2100,	1.64	2.12	1.77	0.91	1.63	1.63	0.85	0.63	0.82
20V-2100	2.4	13.7	73.7	23.1	41.4	41.402	35.4	16.0	20.8

**FLANGE LOADING**

Part Number	Pull-Out Strength* Lbs (kN)
20V-2000/2100	449 2.0
20P-2000/2100	360 1.6

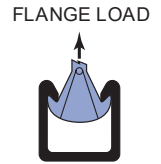

\*Values shown represent a 3:1 safety factor

**20P-2200, 20V-2200**

**SLOTTED CHANNEL**

Slots are 1" (25.4) x 7/16" (11.1)  
2" (50.8) on Center

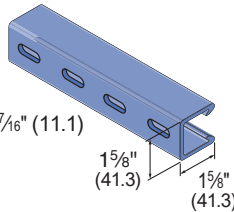

W/100 Ft: 82 Lbs (122 kg/100 m)

**20P-2300, 20V-2300**

**w/CONCRETE INSERT**

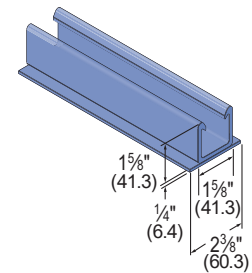

W/100 Ft: 88 Lbs (131 kg/100 m)

**20P-2000, 20V-2000**

**CHANNEL BEAM/COLUMN LOADING**

Span In (mm)	Max. Uniform Beam Load (Safety Factor - 3:1)		Uniform Load at Deflection of 1/360 Span		Maximum Column Load Lbs (kN)
	Load Lbs (kN)	Deflection In (mm)	Load Lbs (kN)	Deflection In (mm)	
12	3,561	0.102	1,159	0.033	5,160
304.8	15.8	2.6	5.2	0.8	23.0
18	2,374	0.23	515	0.05	4,704
457.2	10.6	5.8	2.3	1.3	20.9
24	1,781	0.41	290	0.067	4,168
609.6	7.9	10.4	1.3	1.7	18.5
30	1,424	0.64	185	0.083	3,553
762.0	6.3	16.3	0.8	2.1	15.8
36	1,187	0.922	129	0.1	2,859
914.4	5.3	23.4	0.6	2.5	12.7
48	890	1.638	72	0.133	1,636
1,219.2	4.0	41.6	0.3	3.4	7.3
60	712	2.56	46	0.167	1,047
1,524.0	3.2	65	0.2	4.2	4.7
72	594	3.686	32	0.2	727
1,828.8	2.6	93.6	0.1	5.1	3.2

**20P-2100, 20V-21000**

**CHANNEL BEAM/COLUMN LOADING**

Span In (mm)	Max. Uniform Beam Load (Safety Factor - 3:1)		Uniform Load at Deflection of 1/360 Span		Maximum Column Load Lbs (kN)
	Load Lbs (kN)	Deflection In (mm)	Load Lbs (kN)	Deflection In (mm)	
12	5,559	0.028	5,559	0.033	9,454
304.8	24.7	0.7	24.7	0.8	42.1
18	3,706	0.064	2,914	0.05	8,866
457.2	16.5	1.6	13.0	1.3	39.4
24	2,780	0.113	1,639	0.067	8,181
609.6	12.4	2.9	7.3	1.7	36.4
30	2,224	0.177	1,049	0.083	7,405
762.0	9.9	4.5	4.7	2.1	32.9
36	1,853	0.254	730	0.1	6,451
914.4	8.2	6.5	3.2	2.5	28.7
48	1,390	0.452	410	0.133	4,534
1,219.2	6.2	11.5	1.8	3.4	20.2
60	1,112	0.707	262	0.167	2,902
1,524.0	4.9	18.0	1.2	4.2	12.9
72	927	1.018	182	0.2	2,015
1,828.8	4.1	25.9	0.8	5.1	9.0

**Light Duty Channel - Aickinstrut flange Profile**

**20P-1000, 20V-1000**

**LIGHT DUTY SINGLE CHANNEL - AICKINSTRUT FLANGE PROFILE**

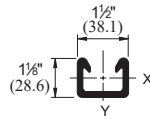
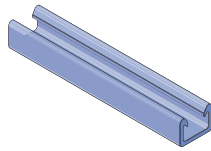

W/100 Ft: 47 Lbs (70 kg/100 m)

**20P-1100, 20V-1100**

**LIGHT DUTY BACK-TO-BACK CHANNEL - AICKINSTRUT FLANGE PROFILE**

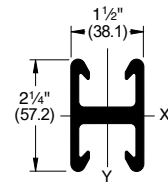
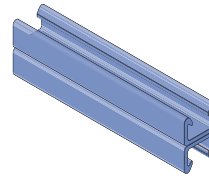

W/100 Ft: 94 Lbs (140 kg/100 m)

**SECTION PROPERTIES**

Part Number	Weight lbs./ft. (kg/m)	Area in <sup>2</sup> (mm <sup>2</sup> )	X - X Axis			Y - Y Axis			
			I in <sup>4</sup> (mm <sup>4</sup> )	R In (mm)	C1 In (mm)	C2 In (mm)	I in <sup>4</sup> (mm <sup>4</sup> )	R In (mm)	C In (mm)
20P-1000, 20V-1000	0.47	0.61	0.1	0.4	0.51	0.62	0.22	0.6	0.75
20P-1100, 20V-1100	0.7	3.9	4.2	10	13	16	9.2	15	19
20P-1000, 20V-1000	0.94	1.22	0.42	0.59	1.13	1.13	0.44	0.6	0.75
20P-1100, 20V-1100	1.4	7.9	17.5	15	29	28	18.3	15	19.1

**FLANGE LOADING**

Part Number	Pull-Out Strength* Lbs (kN)
20V-1000/1100	213 1.0
20P-1000/1100	213 1.0

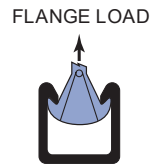

\*Values shown represent a 3:1 safety factor

**20P-1200, 20V-1200**

**SLOTTED CHANNEL**

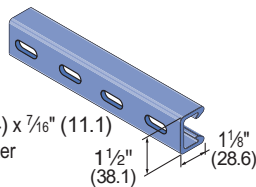

Slots are 1" (25.4) x 7/16" (11.1)  
2" (50.8) on Center

W/100 Ft: 47 Lbs (70 kg/100 m)

**20P-1300, 20V-1300**

**W/CONCRETE INSERT**

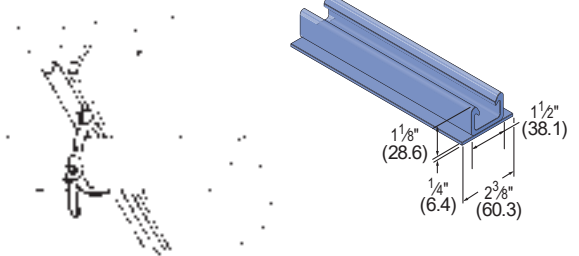

W/100 Ft: 53 Lbs (79 kg/100 m)

**20P-1000, 20V-1000**

**CHANNEL BEAM/COLUMN LOADING**

Span In (mm)	Max. Uniform Beam Load (Safety Factor - 3:1)		Uniform Load at Deflection of 1/360 Span		Maximum Column Load Lbs (kN)
	Load Lbs (kN)	Deflection In (mm)	Load Lbs (kN)	Deflection In (mm)	
12	1,629	0.151	359	0.033	2,759
304.8	7.2	3.8	1.6	0.8	12.3
18	1,086	0.340	160	0.050	2,351
457.2	4.8	8.6	0.7	1.3	10.5
24	815	0.605	90	0.067	1,862
609.6	3.6	15.4	0.4	1.7	8.3
30	652	0.945	57	0.083	1,298
762.0	2.9	24.0	0.3	2.1	5.8
36	543	1.360	40	0.100	901
914.4	2.4	34.5	0.2	2.5	4.0
48	407	2.418	22	0.133	507
1,219.2	1.8	61.4	0.1	3.4	2.3
60	326	3.779	14	0.167	324
1,524.0	1.5	96.0	0.1	4.2	1.4
72	272	5.441	10	0.200	225
1,828.8	1.2	138.2	0.0	5.1	1.0

**20P-1100, 20V-1100**

**CHANNEL BEAM/COLUMN LOADING**

Span In (mm)	Max. Uniform Beam Load (Safety Factor - 3:1)		Uniform Load at Deflection of 1/360 Span		Maximum Column Load Lbs (kN)
	Load Lbs (kN)	Deflection In (mm)	Load Lbs (kN)	Deflection In (mm)	
12	3,804	0.082	1,556	0.033	5,961
304.8	16.9	2.1	6.9	0.8	26.5
18	2,536	0.183	691	0.05	5,509
457.2	11.3	4.6	3.1	1.3	24.5
24	1,902	0.326	389	0.067	4,979
609.6	8.5	8.3	1.7	1.7	22.1
30	1,522	0.509	249	0.083	4,375
762.0	6.8	12.9	1.1	2.1	19.5
36	1,268	0.734	173	0.1	3,698
914.4	5.6	18.6	0.8	2.5	16.4
48	951	1.304	97	0.133	2,254
1,219.2	4.2	33.1	0.4	3.4	10.0
60	761	2.038	62	0.167	1,442
1,524.0	3.4	51.8	0.3	4.2	6.4
72	634	2.935	43	0.2	1,001
1,828.8	2.8	74.5	0.2	5.1	4.5



1 1/4" System

1 3/16" System

Fiberglass System

Special Metals

PrimeAngle

Metal Grating

Roofwalk

Index

**20P-2000 SST, 20V-2000 SST**  
**HEAVY DUTY SINGLE CHANNEL - SST PROFILE**

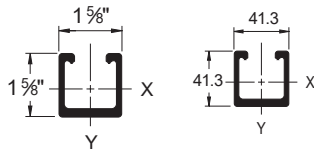
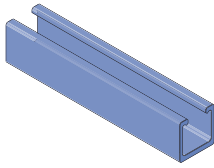

W/100 Ft: 82 Lbs (122 kg/100 m)

**20P-2100 SST, 20V-2100 SST**  
**HEAVY DUTY BACK-TO-BACK CHANNEL - SST PROFILE**

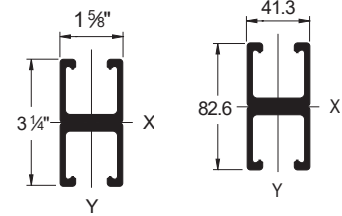
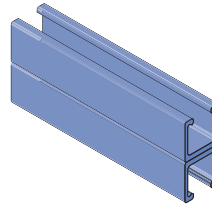

W/100 Ft: 164 Lbs (244 kg/100 m)

**20P-2200 SST, 20V-2200 SST** **SLOTTED CHANNEL**

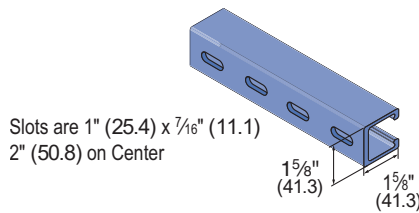

Slots are 1" (25.4) x 7/16" (11.1)  
2" (50.8) on Center

W/100 Ft: 82 Lbs (122 kg/100 m)

**20P-2300 SST, 20V-2300 SST** **W/CONCRETE INSERT**

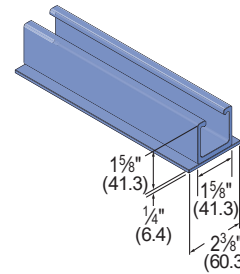

W/100 Ft: 88 Lbs (131 kg/100 m)

**NOTE:** Unistrut SST Channel is not compatible with the Unistrut fiberglass pipe clamps and channel nuts shown in this catalog. Metal clamps and channel nuts are compatible with this profile and are shown elsewhere in this catalog.

**20P-2000 SST, F20V-2000 SST**  
**CHANNEL BEAM/COLUMN LOADING**

Span In (mm)	Maximum Uniform Beam Load (Safety Factor - 3:1)		Deflection @Max. Allowable Beam Load		Deflection @Max. Deflection = 0.25 In (Lbs)		Uniform Load @Max. Deflection = 0.50 In (Lbs)		Max. Column Load Lbs (kN)
	Poly Lbs (kN)	Vinyl Lbs (kN)	Poly In (mm)	Vinyl In (mm)	Poly Lbs (kN)	Vinyl Lbs (kN)	Poly Lbs (kN)	Vinyl Lbs (kN)	
12	1,720	2,150	0.07	0.07	—	—	—	—	3,650
304.8	7.6	9.6	1.8	1.8	—	—	—	—	16.2
18	1,150	1,440	0.15	0.17	—	—	—	—	3,370
457.2	5.1	6.4	3.8	4.3	—	—	—	—	15.0
24	860	1,080	0.27	0.3	810	910	—	—	2,960
609.6	3.8	4.8	6.9	7.6	3.6	4.0	—	—	13.2
30	690	870	0.42	0.48	410	460	—	—	2,450
762.0	3.1	3.9	10.7	12.2	1.8	2.0	—	—	10.9
36	580	730	0.61	0.69	240	270	480	540	1,800
914.4	2.6	3.2	15.5	17.5	1.1	1.2	2.1	2.4	8.0
48	430	540	1.07	1.2	100	115	200	230	1,010
1,219.2	1.9	2.4	27.2	30.5	0.4	0.5	0.9	1.0	4.5
60	350	440	1.7	1.91	60	70	120	135	260
1,524.0	1.6	2.0	43.2	48.5	0.3	0.3	0.5	0.6	1.2
72	290	370	2.44	2.78	30	34	60	70	NR
1,828.8	1.3	1.6	62.0	70.6	0.1	0.2	0.3	0.3	NR

**20P-2100 SST, F20V-2100 SST**  
**CHANNEL BEAM/COLUMN LOADING**

Span In (mm)	Maximum Uniform Beam Load (Safety Factor - 3:1)		Deflection @Max. Al- lowable Beam Load		Deflection @Max. Deflection = 0.25 In (Lbs)		Uniform Load @Max. Deflection = 0.50 In (Lbs)		Max. Column Load Lbs (kN)
	Poly Lbs (kN)	Vinyl Lbs (kN)	Poly In (mm)	Vinyl In (mm)	Poly Lbs (kN)	Vinyl Lbs (kN)	Poly Lbs (kN)	Vinyl Lbs (kN)	
12	5,080	6,350	0.04	0.04	—	—	—	—	7,300
304.8	22.6	28.2	1.0	1.0	—	—	—	—	32.5
18	3,390	4,240	0.09	0.1	—	—	—	—	6,740
457.2	15.1	18.9	2.3	2.5	—	—	—	—	30.0
24	2,540	3,180	0.16	0.17	—	—	—	—	5,920
609.6	11.3	14.1	4.1	4.3	—	—	—	—	26.3
30	2,040	2,550	0.24	0.27	—	2,350	—	—	4,900
762.0	9.1	11.3	6.1	6.9	—	10.5	—	—	21.8
36	1,700	2,130	0.35	0.39	1,220	1,370	—	—	3,600
914.4	7.6	9.5	8.9	9.9	5.4	6.1	—	—	16.0
48	1,270	1,590	0.62	0.69	520	590	1,040	1,170	2,020
1,219.2	5.6	7.1	15.7	17.5	2.3	2.6	4.6	5.2	9.0
60	1,020	1,280	0.97	1.09	270	310	540	610	520
1,524.0	4.5	5.7	24.6	27.7	1.2	1.4	2.4	2.7	2.3
72	850	1,070	1.4	1.57	160	180	320	360	NR
1,828.8	3.8	4.8	35.6	39.9	0.7	0.8	1.4	1.6	NR



**Fiberglass Channel Nuts & Accessories**

**HEAVY DUTY CHANNEL NUTS**

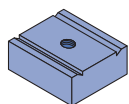

- Heavy duty channel nuts are designed to be used where high thread shear values or spring nuts are required. They can not be used with light duty 1000 series channel or SST profile channel.
- Material: glass-reinforced polyurethane.

Part Number	Size	Thread Shear Lbs (kN)*	Torque Ft/Lbs (N•m)	Wt/100 pcs Lbs (kg)
375PU-CNHD	3/8"-16	1,400 6.23	8 11	5.7 2.6
500PU-CNHD	1/2"-13	1,400 6.23	8 11	5.3 2.4
625PU-CNHD	5/8"-11	1,400 6.23	10 14	5.1 2.3
750PU-CNHD	3/4"-10	1,400 6.23	10 14	4.4 2.0
10PU-CNMHD	10 mm	1,400 6.23	8 11	5.8 2.6
12PU-CNMHD	12 mm	1,400 6.23	8 11	5.5 2.5
16PU-CNMHD	16 mm	1,400 6.23	10 14	5.3 2.4
20PU-CNMHD	20 mm	1,400 6.23	10 14	4.4 2.0

\*Thread shear values shown represent a 3:1 safety factor.

**SADDLE CLIPS**

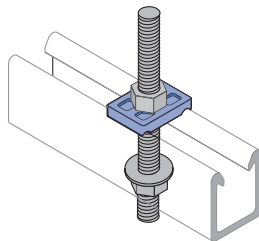

- Saddle clips mate with the exterior of the channel flanges and are secured with threaded rods and nuts.
- Material: glass-reinforced polyurethane.

Part Number	Size (In.)	Wt/100 pcs Lbs (kg)
200-4226	3/8	3.5 1.6
200-4217	1/2	2.5 1.1
200-4341	5/8	3.0 1.4
200-4342	3/4	2.5 1.1

**STOP-LOCK ASSEMBLIES**

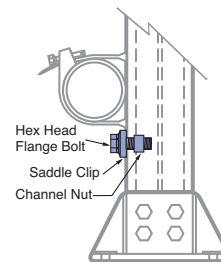

- Stop-Lock Assemblies reduce the chance of pipe slippage when running supports vertically and are recommended for applications that are subject to vibration, have regular contact with fluids or are vertically mounted. The Stop-Locks fit both sizes of channel.
- Material: glass-reinforced polyurethane.

Part Number	Size (in.)	Force Resistance Lbs (kN)*	Torque Ft/Lbs (N•m)	Wt/100 pcs Lbs (kg)
200-4227	3/8"	200 0.9	7 9	6.3 2.9
200-4219	1/2"	220 1.0	12 16	6.4 2.9
200-4343	5/8***	250 1.1	15 20	11.0 5.0

\* Force resistance values shown represents a 3:1 safety factor.

\*\* Supplied with a heavy duty channel nut for use only with the heavy duty series 2000 channel.

**STANDARD DUTY CHANNEL NUTS**

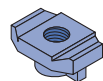

- Standard Duty channel nuts are designed for light duty applications that do not require high thread shear values. They can be used with both light duty series 1000 and heavy duty series 2000 fiberglass channel.
- Not for use with SST profile channel.
- Material: glass-reinforced polyurethane.

Part Number	Size	Thread Shear Lbs (kN)*	Torque Ft/Lbs (N•m)	Wt/100 pcs Lbs (kg)
250PU-CN	1/4"-20	460 2.05	2 3	1.8 0.8
312PU-CN	5/16"-18	460 2.05	2 3	1.7 0.8
375PU-CN	3/8"-16	460 2.05	3 4	1.8 0.8
500PU-CN	1/2"-13	460 2.05	3 4	1.4 0.6
10PU-CN	10 mm	460 2.05	3 4	1.7 0.8
12PU-CN	12 mm	460 2.05	3 4	1.4 0.6
10PU-CNS	#10 Screw	460 2.05	N/A	1.9 0.9

\*Thread shear values shown represent a 3:1 safety factor.

**HEX FLANGE BOLTS**

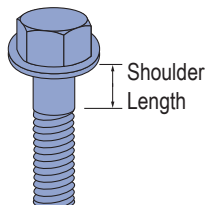

- Fiberfast bolts are ideal for mechanical connections that require a high degree of corrosion resistance. The 3/8" diameter fasteners are recommended for all channel fitting mechanical connections.
- Material: glass-reinforced polyurethane.

Part Number	Size (in.)	Thread Shear Lbs (kN)*	Shank Shear Lbs (kN)*	Shoulder Length In (mm)	Torque Ft/Lbs (N•m)	Wt/100 pcs Lbs (kg)
250PU-075	1/4 x 3/4	110 0.49	210 0.93	Full Thread	0.8 1	.4 0.2
250PU-100	1/4 x 1	110 0.49	210 0.93	Full Thread	0.8 1	.5 .02
250PU-150	1/4 x 1 1/2	110 0.49	210 0.93	1/2 12.7	0.8 1	.6 0.3
500PU-125	1/2 x 1 1/4	450 2.00	870 3.87	Full Thread	8 11	1.0 0.5
500PU-150	1/2 x 1 1/2	450 2.00	870 3.87	Full Thread	8 11	1.1 .05
500PU-200	1/2 x 2	450 2.00	870 3.87	3/4 19.1	8 11	1.3 0.6
500PU-250	1/2 x 2 1/2	450 2.00	870 3.87	Full Thread	8 11	1.6 0.7
500PU-300	1/2 x 3	450 2.00	870 3.87	1 25.4	8 11	1.8 0.8
500PU-350	1/2 x 3 1/2	450 2.00	870 3.87	2 5/16 55.6	8 11	2.0 0.9

\*Thread shear values shown represent a 3:1 safety factor.

1 1/4" System

1 3/16" System

Fiberglass System

Special Metals

PrimeAngle

Metal Grating

Roofwalk

Index



1/4" System

13/16" System

Fiberglass System

Special Metals

PrimeAngle

Metal Grating

Roofwalk

Index

**HEX BOLTS**

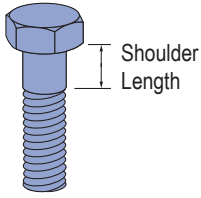

- Fiberfast bolts are ideal for mechanical connections that require a high degree of corrosion resistance. The 3/8" diameter fasteners are recommended for all channel fitting mechanical connections.
- Material: glass-reinforced polyurethane.

Part Number	Size (in.)	Thread Shear Lbs (kN)*	Shank Shear Lbs (kN)*	Shoulder Length In (mm)	Torque Ft/Lbs (Nm)	W/100 pcs Lbs (kg)
375PU-125	3/8 x 1/4	250	470	Full Thread	3	1.0
		1.11	2.09		4	0.5
375PU-150	3/8 x 1/2	250	470	1/4	3	1.1
		1.11	2.09	6.4	4	0.5
375PU-200	3/8 x 2	250	470	1/2	3	1.3
		1.11	2.09	12.7	4	0.6
375PU-250	3/8 x 2 1/2	250	470	3/4	3	1.6
		1.11	2.09	19.1	4	0.7
375PU-300	3/8 x 3	250	470	1	3	1.8
		1.11	2.09	25.4	4	0.8
625PU-125	5/8 x 1/4	700	1,360	1/4	12	2.5
		3.11	6.05	6.4	16	1.1
625PU-150	5/8 x 1/2	700	1,360	1/4	12	2.8
		3.11	6.05	6.4	16	1.3
625PU-200	5/8 x 2	700	1,360	1/4	12	3.2
		3.11	6.05	6.4	16	1.5
625PU-250	5/8 x 2 1/2	700	1,360	1/4	12	3.4
		3.11	6.05	6.4	16	1.5
625PU-300	5/8 x 3	700	1,360	1/4	12	3.9
		3.11	6.05	6.4	16	1.8
625PU-350	5/8 x 3 1/2	700	1,360	1/4	12	5.5
		3.11	6.05	6.4	16	2.5

\*Thread shear values shown represent a 3:1 safety factor.

**FLAT WASHERS**

Material: PVC

Note: PVC washers are recommended for connections that utilize hex nuts and bolts.

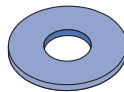

Part Number	Size (in.)	Outside Diameter In (mm)	W/100 pcs Lbs (kg)
250E-999	1/4	0.49	0.1
		12	0.05
375E-999	3/8	1.00	0.1
		25	0.05
500E-999	1/2	1.25	0.5
		32	0.2
625E-999	5/8	1.50	0.5
		38	0.2
750E-999	3/4	1.50	1.0
		38	0.5
1000E-999	1	2.25	1.5
		57	0.7

**HEX FLANGE NUTS**

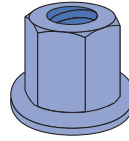

- The hex flange nut is preferred for applications that require additional thread engagement (such as with all-thread rod) or maximum thread shear strength.
- Material: glass-reinforced polyurethane.

Part Number	Size (in.)	Thread Shear Lbs (kN)*	Height In (mm)	Torque Ft/Lbs (Nm)	W/100 pcs Lbs (kg)
375PU-FN-000	3/8-16	500	0.750	3	0.8
		2.22	19.1	4	0.4
500PU-FN-000	1/2-13	1,200	0.855	8	1.6
		5.34	21.7	11	0.7
625PU-FN-000	5/8-11	2,200	1.220	12	3.5
		9.79	31.0	16	1.6
750PU-FN-000	3/4-10	2,900	1.590	15	5.5
		12.90	40.4	20	2.5

\*Thread shear values shown represent a 3:1 safety factor.

**HEX NUTS**

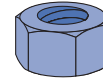

Part Number	Size (in.)	Thread Shear Lbs (kN)*	Height In (mm)	Torque Ft/Lbs (Nm)	W/100 pcs Lbs (kg)
250PU-000	1/4-20	150	0.218	0.8	0.1
		0.67	5.5	1	0.05
375PU-000	3/8-16	460	0.328	3	0.3
		2.05	8.3	4	0.1
500PU-000	1/2-13	800	0.437	8	0.5
		3.56	11.1	11	0.2
625PU-000	5/8-11	1,000	0.546	12	1.5
		4.45	13.9	16	0.7

\*Thread shear values shown represent a 3:1 safety factor.

**50PU-500SP**

**CHANNEL SPACERS**

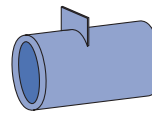

- Channel spacers are designed to prevent wall compression under heavy loading conditions. Such loading occurs during the torquing of hardware for channel fittings.
- The spacers are designed to be used only with 15/8" channels and will accommodate 3/8" and 1/2" bolts.
- Material: molded from polyurethane

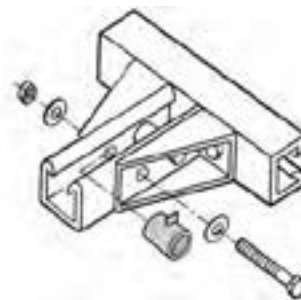

W/100 pcs: 2.0 Lbs (.91 kg)

**Fiberglass Hardware**

**THREADED ROD**

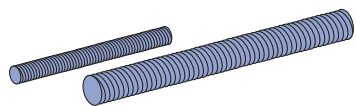

Material: pultruded vinyl ester resin and is gray in color.

\* Thread shear values shown represent a 3:1 safety factor.  
\*\* Standard lengths are 4' and 8'. The part number shown is for 4' lengths. To order eight foot lengths, add suffix "-96" to part number (Example: F200-3827-96)

Part Number	Size (in.)	Weight Lbs (kg)	Thread Shear Lbs (kN)*	Torque Ft/Lbs (Nm)	W/100 pcs 4' in Len. Lbs (kg)
200-3827	3/8-16	0.07	415	5	35
		0.03	1.85	7	15.9
200-3828	1/2-13	0.12	570	10	57
		0.05	2.54	14	25.9
200-3829	5/8-11	0.18	1,260	40	91
		0.08	5.60	54	41.3
200-3830	3/4-10	0.28	1,700	50	133
		0.13	7.56	68	60.3
200-3831	1-8	0.50	3,000	60	200
		0.23	13.34	81	90.7

**A-KONNECTOR ROD COUPLERS**

A-Konnectors provide an excellent means for extending FRP all-thread rods beyond their standard lengths. A-Konnectors are manufactured from glass-reinforced polyurethane and are colored gray. A-Konnectors are packaged in bags containing 25 pieces.

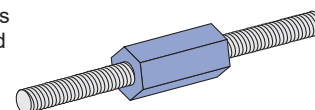

Part Number	Size (in.)	Length In (mm)	Thread Shear Lbs (kN)*	W/100 pcs Lbs (kg)
200-3840	3/8-16	2 1/4	800	6.5
		57.2	3.56	2.9
200-3841	1/2-13	2 1/4	870	6.0
		57.2	3.87	2.7
200-3842	5/8-11	2 1/4	1,500	13.0
		57.2	6.67	5.9
200-3843	3/4-10	2 1/4	1,500	11.0
		57.2	6.67	5.0

\* Thread shear values shown represent a 3:1 safety factor.

**AIC-EC – CHANNEL END CAP**

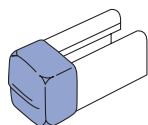

- Material: red PVC and designed for 1 1/2" channel.
- End caps are desired when the ends of the channel need to be enclosed. The cap easily installs by pressing it onto the end of the channel opening.

W/100 pcs: 3.4 Lbs (1.5 kg)

**20E-5000 – CHANNEL CAPPING STRIP**

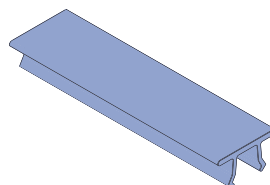

- Material: PVC
- Installs simply by pressing it onto the channel opening. It is designed to be used when a cover is desired for the channel opening (such as concrete embedment channel).

Supplied in 10 foot lengths.

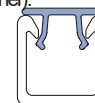

W/100 Ft: 5 Lbs (7.4 kg/100 m)

**NONMETALLIC U-BOLTS**

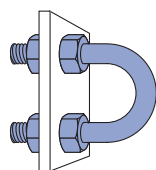
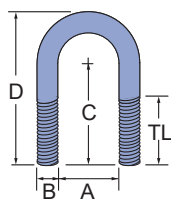

Note: Plate not included. Illustration purpose only

Part Number	Size In	"A" Dim. In (mm)	"B" Dim. In (mm)	"C" Dim. In (mm)	"D" Dim. In (mm)	"TL" Dim. In (mm)	Load Lbs (kN)*	Torque In/Lbs (Nm)	W/100 pcs Lbs (kg)
UB-050	1/2	0.937	0.375	1.568	2.412	1.25	135	40	3
		23.8	9.5	39.8	61.3	31.8	0.60	5	1.4
UB-075	3/4	1.125	0.375	1.662	2.600	1.25	135	40	3
		28.6	9.5	42.2	66.0	31.8	0.60	5	1.4
UB-100	1	1.375	0.375	1.787	2.850	1.25	135	40	4
		34.9	9.5	45.4	72.4	31.8	0.60	5	1.8
UB-125	1 1/4	1.687	0.375	1.943	3.162	1.25	135	40	4
		42.8	9.5	49.4	80.3	31.8	0.60	5	1.8
UB-150	1 1/2	2.000	0.375	2.100	3.475	1.25	135	40	5
		50.8	9.5	53.3	88.3	31.8	0.60	5	2.3
UB-200	2	2.437	0.500	2.468	4.187	1.50	135	80	10
		61.9	12.7	62.7	106.3	38.1	0.60	9	4.5
UB-250	2 1/2	2.937	0.500	2.718	4.687	1.50	135	80	11
		74.6	12.7	69.0	119.0	38.1	0.60	9	5.0
UB-300	3	3.562	0.500	3.031	5.312	1.50	135	80	14
		90.5	12.7	77.0	134.9	38.1	0.60	9	6.4
UB-350	3 1/2	4.062	0.500	3.281	5.812	1.50	135	80	15
		103.2	12.7	83.3	147.6	38.1	0.60	9	6.8
UB-400	4	4.562	0.500	3.531	6.312	1.50	135	80	16
		115.9	12.7	89.7	160.3	38.1	0.60	9	7.3
UB-600	6	6.750	0.625	5.750	9.875	3.25	135	120	17
		171.5	15.9	146.1	250.8	82.6	0.60	14	7.7

\*Torque and load values shown represent a 3:1 safety factor.

- Unistrut Nonmetallic U-Bolts provide a corrosion resistant alternative to traditional metallic U-Bolts. They have oversized diameters which allow them to hold steel conduit and plastic pipe. These bolts will outlast stainless steel in most corrosive applications.
- Each U-Bolt comes with two polyurethane hex nuts. Additional nuts and washers can be purchased separately.
- Material: glass-reinforced polyurethane



**CHANNEL FITTINGS**

• Channel Fittings are required to fabricate structures and are easily attached to Channels with channel nuts and polyurethane fasteners. The fittings are offered in two types; fabricated (cut from flat stock) or molded.

- Material (Fabricated Fittings): Either polyester (P Series) or vinyl ester (V Series) material.
- Material (Molded Fittings): All molded fittings with the exception of the post bases are molded in polyurethane.

Note: The drawings for all fittings are shown with the Aickinstrut flange profile, however they can be used with either channel profile. All fittings are provided with 13/32" holes which accommodate 3/8" hardware. However several of the molded fittings are 1/4" thick and come with 9/16" holes which accommodate 1/2" hardware.

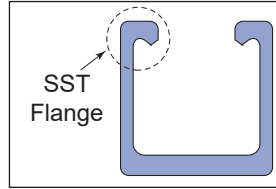
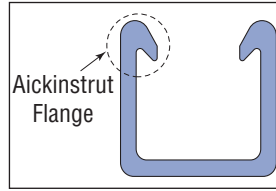

**20P-2500, 20V-2500**

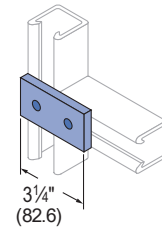

W/100 pcs: 12 Lbs (5.4 kg)

**20P-2508, 20V-2508**

**20P-2502, 20V-2502**

**20P-2504, 20V-2504**

**20P-2506, 20V-2506**

1/4" System

13/16" System

Fiberglass System

Special Metals

PrimeAngle

Metal Grating

Roofwalk

Index

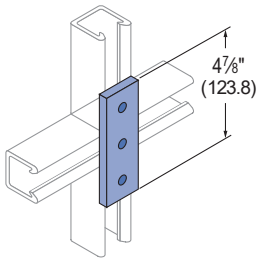

W/100 pcs: 17 Lbs (7.7 kg)

**20P-2510, 20V-2510**

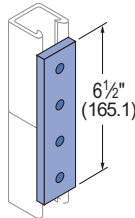

W/100 pcs: 24 Lbs (10.9 kg)

**20P-2512, 20V-2512**

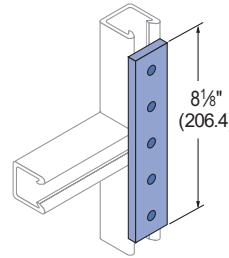

W/100 pcs: 32 Lbs (14.5 kg)

**20P-2514, 20V-2514**

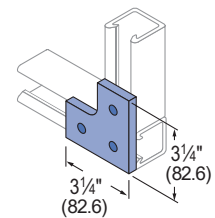

W/100 pcs: 17 Lbs (7.7 kg)

**20P-2516, 20V-2516**

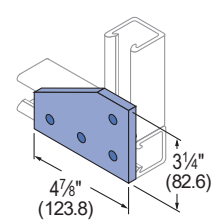
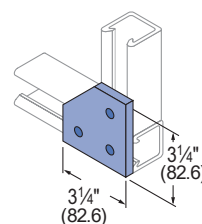
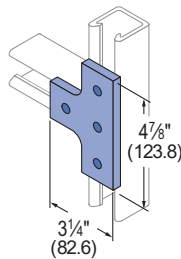
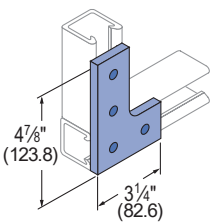

W/100 pcs: 25 Lbs (11.3 kg)

**20P-2518, 20V-2518**

W/100 pcs: 26 Lbs (11.8 kg)

**20P-2520, 20V-2520**

W/100 pcs: 20 Lbs (9.1 kg)

**20P-2522, 20V-2522**

W/100 pcs: 32 Lbs (14.5 kg)

**20P-2524, 20V-2524**

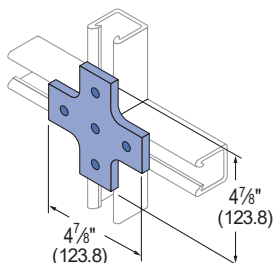

W/100 pcs: 33 Lbs (15.0 kg)

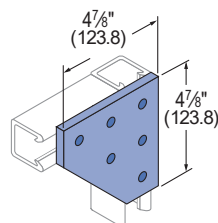

W/100 pcs: 45 Lbs (20.4 kg)

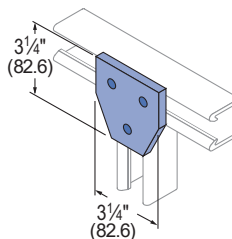

W/100 pcs: 21 Lbs (9.5 kg)

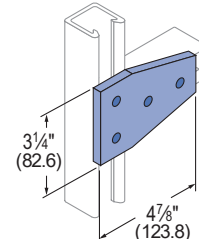

W/100 pcs: 32 Lbs (14.5 kg)

**Flat Fiberglass Fittings**

**20P-2526, 20V-2526**

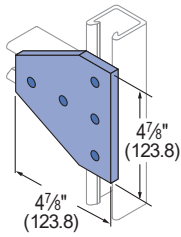

WW/100 pcs: 45 Lbs (20.4 kg)

**20P-2528, 20V-2528**

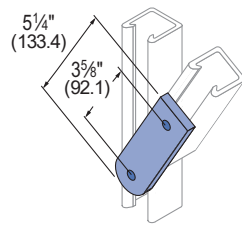

WW/100 pcs: 20 Lbs (9.1 kg)

**20P-2530, 20V-2530**

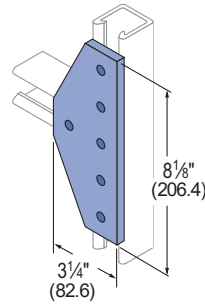

WW/100 pcs: 50 Lbs (22.7 kg)

**20P-2534, 20V-2534**

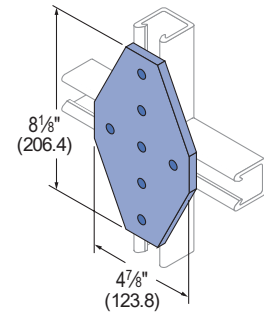

WW/100 pcs: 77 Lbs (34.9 kg)

**20P-2540, F20V-2540**

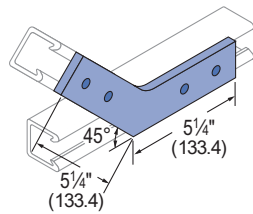

WW/100 pcs: 41 Lbs (18.6 kg)

**50PU-2538**

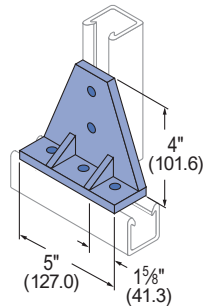

WW/100 pcs: 57 Lbs (26.0 kg)

**50PU-2611**

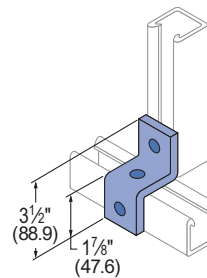

WW/100 pcs: 9 Lbs (4.1 kg)

**50PU-2613**

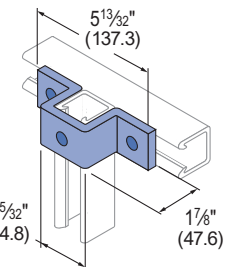

WW/100 pcs: 16 Lbs (7.3 kg)

**50PU-1508 (1 1/2\"),  
50PU-2008 (1 5/8\")**

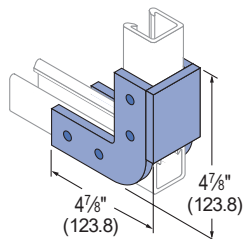

WW/100 pcs: 27 Lbs (12.2 kg)

**50PU-2045 (1 5/8\")**

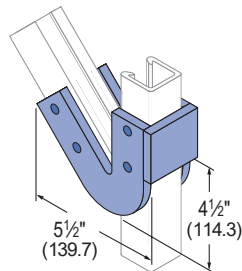

WW/100 pcs: 35 Lbs (15.9 kg)

**50PU-2636**

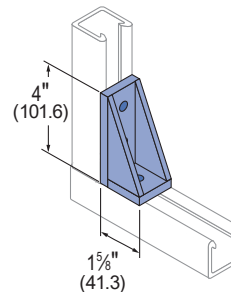

WW/100 pcs: 14 Lbs (6.4 kg)

**50PU-2090 (1 5/8\")**

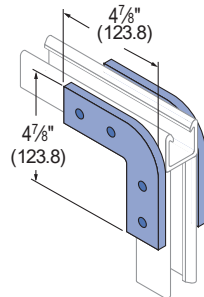

WW/100 pcs: 35 Lbs (15.9 kg)

**50PU-2616**

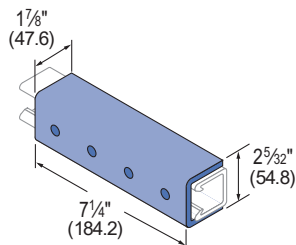

WW/100 pcs: 51 Lbs (23.1 kg)

**20PU-5853 (1 5/8\"),  
20PU-5855 (1 1/8\")**

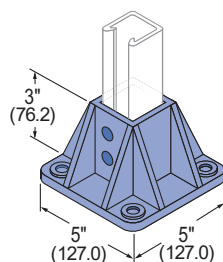

WW/100 pcs: 71 Lbs (32.2 kg)

**20PU-5903 (3 1/4\"),  
20PU-5905 (2 1/4\")**

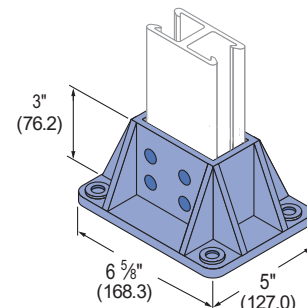

WW/100 pcs: 86 Lbs (39.0 kg)

1 1/4" System

1 3/16" System

Fiberglass System

Special Metals

PrimeAngle

Metal Grating

Roofwalk

Index



1/4" System

13/16" System

Fiberglass System

Special Metals

PrimeAngle

Metal Grating

Roofwalk

Index

**ADJUSTABLE PIPE CLAMPS**

- Unistrut Adjustable Pipe Clamps are manufactured from glass-reinforced polyurethane and are adjustable to accommodate a wide range of outside diameters. They can be utilized with a variety of piping systems including: PVC, fiberglass, copper, rigid steel conduit and PVC coated rigid steel conduit.
- Care should be taken not to exceed 3 ft./lbs. of torque on the adjustable pipe straps.

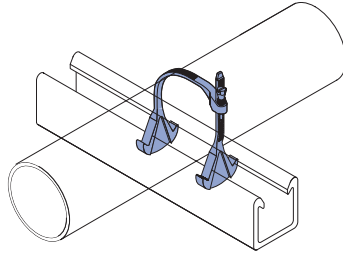

Part Number	O.D. Pipe Size (in.)	Design Load		Torque Ft/Lbs (N•m)	Wt/100 pcs Lbs (kg)
		Type 1 Lbs (kN)	Type 2 Lbs (kN)		
200-3100	1/2–1 1/2	135 (0.6)	65 (0.3)	0.8 (1)	3 (1.4)
200-3110	1 1/2–2 1/4	135 (0.6)	65 (0.3)	3 (4)	5 (2.3)
200-3120	2 1/4–3 1/4	145 (0.6)	70 (0.3)	3 (4)	5 (2.3)
200-3130	3–4	215 (1.0)	70 (0.3)	3 (4)	8 (3.6)
200-3140	4–6 1/2	215 (1.0)	70 (0.3)	3 (4)	10 (4.5)

\*Design loads shown represent a 3:1 safety factor.

**RIGID PIPE CLAMPS**

Part Number	PVC, Sch. 80 Design Loads*		FRP Bolt				
	Nominal & Rigid Metal Size (in.)	In (mm)	Type 1 Lbs (kN)	Type 2 Lbs (kN)	FRP Bolt Size (in.)	Torque Ft/Lbs (N•m)	Wt/100 pcs Lbs (kg)
PCR-050	1/2	0.840 (21.3)	225 (1.0)	90 (0.4)	3/8 x 1 1/4	3 (4)	3 (1.4)
PCR-075	3/4	1.050 (26.7)	225 (1.0)	90 (0.4)	3/8 x 1 1/4		3 (1.4)
PCR-100	1	1.315 (33.4)	225 (1.0)	90 (0.4)	3/8 x 1 1/4		4 (1.8)
PCR-125	1 1/4	1.660 (42.2)	225 (1.0)	90 (0.4)	3/8 x 1 1/4		5 (2.3)
PCR-150	1 1/2	1.900 (48.3)	225 (1.0)	90 (0.4)	3/8 x 1 1/4		5 (2.3)
PCR-200	2	2.375 (60.3)	225 (1.0)	90 (0.4)	3/8 x 1 1/4		5 (2.3)
PCR-250	2 1/2	2.875 (73.0)	225 (1.0)	90 (0.4)	3/8 x 1 1/4		7 (3.2)
PCR-300	3	3.500 (88.9)	225 (1.0)	90 (0.4)	3/8 x 1 1/4		10 (4.5)
PCR-400	4	4.500 (114.3)	300 (1.3)	125 (0.6)	3/8 x 1 1/4		12 (5.4)
PCR-600	6	6.625 (168.3)	300 (1.3)	125 (0.6)	3/8 x 1 1/4		15 (6.8)
PCR-800	8	8.625 (219.1)	300 (1.3)	125 (0.6)	3/8 x 1 1/4	18 (8.1)	

\*Design loads shown represent a 3:1 safety factor.

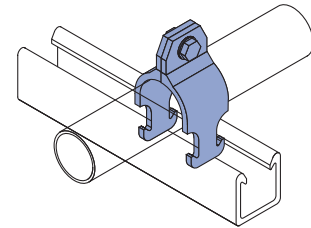

Rigid Pipe Clamps resemble the more traditional style of pipe clamps and are sized based on the pipe inside diameter or nominal size. Polyurethane clamps are recommended for applications up to 160° F. For high temperature applications (up to 230° F). Care should be taken not to exceed the recommended torque values of the rigid pipe clamps. Material: glass-reinforced polyurethane.

**TWO HOLE PIPE STRAPS**

Part No.	Dimension		Bolt Size (in.)	Material Size (in.)	Design Load (lbs)*		Torque (ft./lbs.)		
	A (in.)	B (in.)			Type 1	Type 2			
PS050	0.840	4.840	1/2	1/4 X 1 1/8	135	50	4		
PS075	1.050	5.050							
PS100	1.315	5.315							
PS150	1.900	5.900							
PS200	2 3/8	6.375							
PS250	2 7/8	6.875			175	60			
PS300	3 1/2	7.500							
PS350	4	8.000							
PS400	4 1/2	8.500							
PS500	5 9/16	9.563						225	125
PS600	6 5/8	10.625							
PS800	8 5/8	12.625							
PS1000	10 3/4	15.750	5/8	1/4 X 1 1/8	225	125			
PS1200	12 3/4	16.250							
PS1400	14	18.000							
PS1600	16	20.000					3/8 X 1 1/8	250	150
PS1800	18	23.000							

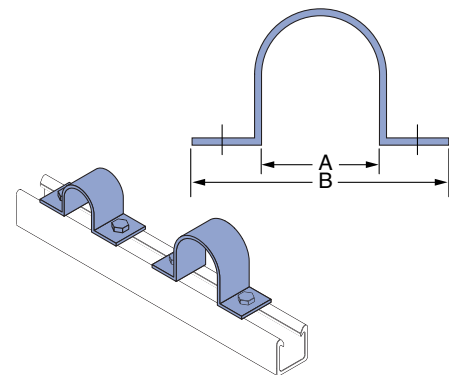

- Two Hole Pipe Straps are designed for use in securing pipe, conduit and ducts to Channel. Two hole fiberglass straps can also be used independently from the channel for surface mounting. All sizes of the straps are suitable for load bearing applications.
- Material: fire-retardant, glass-reinforced polyester resin.
- For extreme chemical environments, the straps can be manufactured from vinyl ester resin. Larger diameter straps for special applications are also available. Contact the factory for pricing and availability of vinyl ester and large diameter straps. Two hole pipe straps should not be torqued above recommended values.

Notes:

- (1) Bolts and channel nuts are sold separately.
- (2) When bolting onto 1 1/2" channel a 1 1/4" long bolt is req'd.

**Fiberglass Clevis Hangers and Channel Insert**

**MOLDED CLEVIS HANGERS**

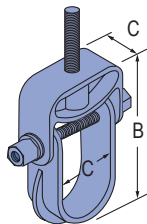

Material: glass-reinforced polyurethane.

\*Design load values shown represent a 3:1 safety factor.

Part Number	Nominal Diameter In (mm)	Max. Pipe O.D. In (mm)	"A" Dim. In (mm)	"B" Dim. In (mm)	"C" Dim. In (mm)	Hanger Rod In (mm)	Load* Lbs (kN)	W/100 pcs Lbs (kg)
CVHPU-100	1/2 - 1	1	1.500	4.25	1.25	1/2	670	29
	12.7 - 25.4	25.4	38.1	108	32	12.7	2.98	13.2
CVHPU-150	1 1/4 - 1 1/2	1 1/2	2.000	5.14	1.25	1/2	670	40
	31.8 - 38.1	38.1	50.8	131	32	12.7	2.98	18.1
CVHPU-200	1 1/2 - 2	2	2.500	6.52	1.25	1/2	730	43
	38.1 - 50.8	50.8	63.5	166	32	12.7	3.25	19.5
CVHPU-400	2 1/2 - 4	4	5.125	10.00	1.50	1/2	1,150	129
	63.5 - 101.6	101.6	130.2	254	38	12.7	5.12	58.5
CVHPU-600	4 1/2 - 6	6	6.750	12.33	1.50	1/2	1,170	168
	114.3 - 152.4	152.4	171.5	313	38	12.7	5.20	76.2

**FABRICATED CLEVIS HANGERS**

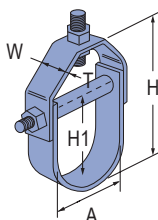

Material: glass-reinforced polyester resin.

\*Design load values shown represent a 3:1 safety factor.

Part Number	Size Range In (mm)	Dimensions - In (mm)					Hanger Rod In (mm)	Trans Rod In (mm)	Spreader Rod O.D. In (mm)	Loads* Lbs (kN)	W/100 pcs Lbs (kg)
		A	T	H	H1	W					
100-1500	1-1 1/2	1/8	2 3/4	1 7/8	1 1/2	1/2	3/8	1/2	60	21	
	25.4 - 38.1	3.2	69.9	47.6	38.1	12.7	9.5	12.7	0.27	9.5	
100-1501	1 1/2 - 2	1/8	3 1/2	2 3/8	1 1/2	1/2	3/8	1/2	60	25	
	38.1 - 50.8	3.2	88.9	60.3	38.1	12.7	9.5	12.7	0.27	11.3	
100-1502	2 - 2 5/8	1/8	4 3/4	3	2	1/2	3/8	1/2	90	55	
	50.8 - 66.7	3.2	120.7	76.2	50.8	12.7	9.5	12.7	0.40	24.9	
100-1503	2 1/2 - 3 1/4	1/8	5 1/2	3 3/8	2	1/2	3/8	1/2	120	57	
	63.5 - 82.6	3.2	139.7	92.1	50.8	12.7	9.5	12.7	0.53	25.9	
100-1504	3 - 3 3/8	1/8	7	4 1/4	2	3/4	3/8	1/2	160	61	
	76.2 - 98.4	3.2	177.8	108.0	50.8	15.9	9.5	12.7	0.71	27.7	
100-1505	4 - 5 1/8	13/16	8 1/2	5 3/8	2	3/4	3/8	1/2	250	82	
	101.6 - 130.2	20.6	215.9	142.9	50.8	15.9	9.5	12.7	1.11	37.2	
100-1506	6 - 7 1/8	13/16	10 3/8	7 1/2	3	3/4	3/8	1/2	300	136	
	152.4 - 181.0	20.6	276.2	190.5	76.2	15.9	9.5	12.7	1.33	61.7	
100-1507	8 - 9 1/4	1/4	14	9 3/4	3	3/4	3/8	1/2	350	189	
	203.2 - 235.0	6.4	355.6	247.7	76.2	15.9	9.5	12.7	1.56	85.7	
100-1508	10 - 11 3/8	1/4	18	12	4	3/4	3/8	3/4	450	333	
	254.0 - 288.9	6.4	457.2	304.8	101.6	15.9	12.7	19.1	2.00	151.0	
100-1509	12 - 13 1/2	1/4	21 1/2	14 3/8	5	3/4	3/8	3/4	600	350	
	304.8 - 342.9	6.4	546.1	358.8	127.0	15.9	12.7	19.1	2.67	158.8	
100-1510	14 - 15 3/4	1/4	24 1/2	16 1/2	5	3/4	3/8	3/4	700	872	
	355.6 - 400.1	6.4	622.3	419.1	127.0	19.1	12.7	19.1	3.11	395.5	
100-1511	16 - 18	3/8	27 3/8	19 1/2	6	3/4	3/4	1	750	1,023	
	406.4 - 457.2	9.5	695.3	495.3	152.4	19.1	19.1	25.4	3.34	464.0	
100-1512	19 - 21	3/8	34 1/2	22 1/2	6	3/4	3/4	1	800	1,673	
	482.6 - 533.4	9.5	876.3	571.5	152.4	19.1	19.1	25.4	3.56	758.9	
100-1513	21 - 22	1/2	35 1/2	24	6	3/4	3/4	1	850	2,323	
	533.4 - 558.8	12.7	901.7	609.6	152.4	19.1	19.1	25.4	3.78	1,053.7	
100-1514	22 - 24	1/2	41	28	6	3/4	3/4	1	900	2,973	
	558.8 - 609.6	12.7	1,041.4	711.2	152.4	19.1	19.1	25.4	4.00	1,348.5	

**200-4101**

**UNISERT CHANNEL INSERT**

- Unisert is a polyurethane nonmetallic insert which can be used with standard cable ties for securing tubing, conduit and cables to standard metal channels.
- The Unisert works with all 1 1/2" channels that are 13/16" deep or more. One size fits 12, 14 and 16 metal gauge channels.

Note: For use only with metallic channel.

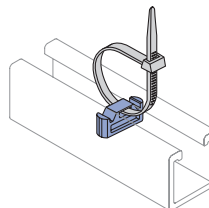

W/100 pcs: 1.0 Lbs (.5 kg)

1 1/4" System  
1 3/16" System  
Fiberglass System  
Special Metals  
PrimeAngle  
Metal Grating  
Roofwalk  
Index



1 1/4" System

1 3/16" System

Fiberglass System

Special Metals

PrimeAngle

Metal Grating

Roofwalk

Index

**375PU & 500PU**

**MOLDED BEAM CLAMPS**

Material: glass-reinforced polyurethane

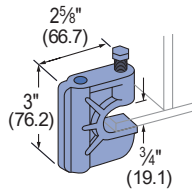

Assembly Part Number	Size In	Thread Shear Lbs (kN)*	Torque Ft/Lbs (N·m)	Wt/100 pcs Lbs (kg)
375PU-BC	3/8	400 1.78	10 14	30 13.6
500PU-BC	1/2	400 1.78	10 14	30 13.6

\*Design load values shown represent a 3:1 safety factor.

**RGBC**

**MOLDED BEAM CLAMP ASSEMBLY**

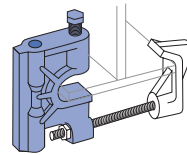

F375PU-BCCLP (3/8")  
Beam Clip Only



Note: Beam clamp clip must be purchased separately. Illustration purpose only

Material: glass-reinforced polyurethane.

Part Number	Size In	Thread Shear Lbs (kN)*	Torque Ft/Lbs (N·m)	Wt/100 pcs Lbs (kg)
RGBC-1	3/8	500 2.22	10 14	43 19.5
RGBC-2	1/2	500 2.22	10 14	43 19.5
RGBC-3	5/8	500 2.22	10 14	43 19.5

\*Design load values shown represent a 3:1 safety factor.

**POWER-RACK STANCHIONS**

The Power-Rack Stanchion is made entirely from glass-reinforced nylon, these stanchions offer greater corrosion resistance than classical metal stanchions. The interlocking design allows the arm to "lock" into nine different levels on the 14 1/4" stanchions and fourteen on the 17 1/2" stanchion. Glass-reinforced polyurethane stanchions are available as a special order. Contact Unistrut for pricing and availability. Dimensions – The stanchion back has 9/16" x 1/16" holes to accept fasteners for mounting. There are two mounting holes in the 21 3/8" long stanchion and three in the 33 3/16" long stanchion. Thickness at the slotted mounting holes is 1 1/8". The mounting holes are spaced on 12" centers and require 1/2" diameter fasteners.

Installation – The Stanchions can be anchored into existing concrete structures using any industrial anchoring system. For new concrete structures, the Stanchions can be mounted to fiberglass concrete embedment channel and attached with 1/2" channel nuts and 1/2"x 3" Fiberfast Bolts.

Fire Retardance – Power-Rack materials meet or exceed the requirements of UL94 HB.

Loading – The recommended allowable loads on Power-Rack Stanchions vary depending upon the position of the arm. Use these guidelines for a safe, reliable installation:

- Total load on any one arm should not exceed 800 lbs.
- The sum of the loads on an arm multiplied by their distances to the wall stanchion should not exceed 1200 in./lbs.

Example: A cable weighing 200 lbs. is positioned on an arm at a distance of 5" from the wall stanchion.

If the total load is less than 800 lbs and the sum of the load multiplied by their distances to the wall stanchion does not exceed 1200 in./lbs., then the system is adequate. In this case,

Total load (200<800 lbs) = OK

Tot. moment (200x5 in. = 1000<1200 in./lbs.) = OK

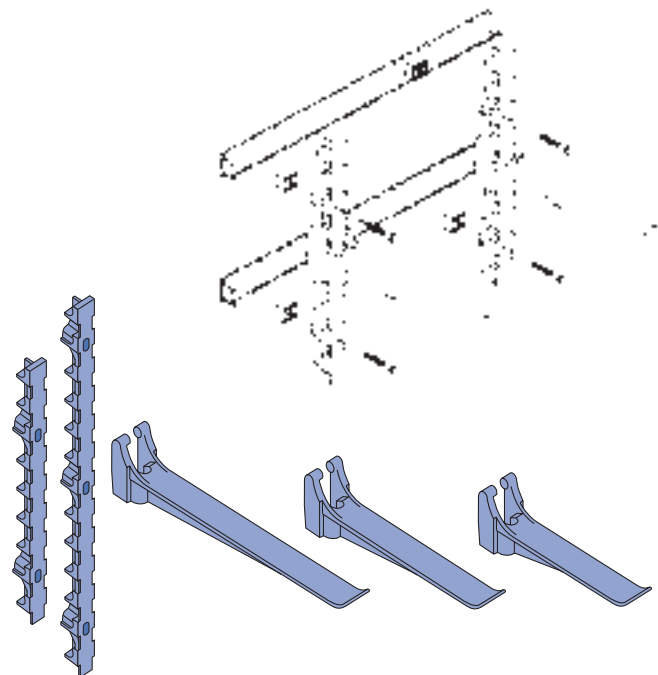

Part No.	Description	Size In (mm)	Wt/100 pcs Lbs (kg)	Load (lbs.)* Lbs (kN)
20N-ARM08	Arm	8 203.2	100 45.4	800 3.56
20N-ARM14	Arm	14 1/4 362.0	116 52.6	800 3.56
20N-ARM17	Arm	17 1/2 444.5	145 65.8	800 3.56
20N-ARM23	Arm	23 7/8 606.4	186 84.4	800 3.56
20N-STA21	Stanchion	21 3/8 542.9	149 67.6	N/A
20N-STA33	Stanchion	33 3/16 846.1	231 104.8	N/A

\*Design load values shown represent a 3:1 safety factor.



**FIBERGLASS CLAMPS DESIGN LOAD INFORMATION**

There are two types of piping system loadings:

- overhead (Type 1) and
- vertical (Type 2)

as described below.

All pipe straps and clamps show the recommended loading for both types of loading.

**Type 1 Overhead Design Load**

The design load shown represents pipes supported below the strut. The design loads shown are based on a minimum ultimate failure safety factor of 3:1.

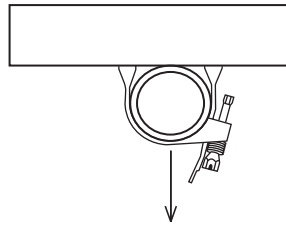

**Type 2 Vertical Design Load**

The design loading shown can be achieved with the addition of a vertical stop lock assembly (Part #F200-4219) installed directly beneath the pipe clamp. The adjacent illustration shows how the vertical stop lock assembly provides additional support for pipe and how it can be used to achieve full Type 2 design loads.

Design loads are based on a minimum clamp slip safety factor of 3:1. It is recommended that stop lock assemblies be used for all vertical pipe support applications.

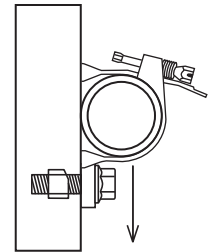

**CHEMICAL COMPATIBILITY TABLE**

Chemical	Series									
	E		P		V		PU		N	
	Rigid PVC		Poly/Glass		Vinyl/Glass		Poly		Nylon	
	70°	160°F	70°	160°F	70°	160°F	70°	160°F	70°	160°F
Acetic Acid, Up to 50%	R	R	R	R	R	R	R	-	nr	nr
Acetone, Up to 10%	nr	nr	nr	nr	nr	nr	R	-	R	R
Aluminum Hydroxide	R	R	R	R	R	R	R	-	nr	nr
Ammonium Hydroxide (Aqueous Ammonia), Up to 5%	R	R	nr	nr	R	R	R	-	-	-
Ammonium Hydroxide (Aqueous Ammonia), Up to 10%	R	R	nr	nr	R	150°	R	-	-	-
Ammonium Hydroxide, Up to 20%	R	R	nr	nr	R	150°	R	-	-	-
Ammonium Nitrate	R	nr	R	R	R	R	R	-	-	-
Ammonium Phosphate	R	R	R	nr	R	R	R	-	-	-
Ammonium Sulfide, saturated	R	R	nr	nr	R	120°	R	-	-	-
Aqua Regia, fumes	nr	nr	nr	nr	R	150°	nr	-	-	-
Benzene	nr	nr	nr	nr	nr	nr	R	R	-	R
Benzoic Acid	R	R	R	R	R	R	R	-	-	-
Bromine, wet gas	R	nr	nr	nr	R	100°	-	-	-	-
Butylene Glycol, Up to 100%	R	R	R	R	R	R	R	-	R	R
Butyric Acid, Up to 50%	nr	nr	R	R	R	R	R	-	-	-
Calcium Hydroxide	R	R	R	nr	R	R	R	-	-	-
Calcium Hypochlorite	R	R	R	nr	R	R	R	-	nr	nr
Chlorine, Dry Gas	nr	nr	nr	nr	R	R	-	-	-	-
Chlorine, Wet Gas	nr	nr	nr	nr	R	R	-	-	-	-
Chlorine, Liquid	nr	nr	nr	nr	nr	nr	-	-	-	-
Chlorine, Water	nr	nr	R	R	R	R	R	-	nr	nr
Chromic Acid, Up to 5%	R	R	nr	nr	R	R	-	-	R	R
Copper Chloride	R	R	R	R	R	R	R	-	-	-
Copper Cyanide	R	R	R	nr	R	R	R	-	-	-
Copper Fluoride	R	R	R	nr	R	R	R	-	-	-
Copper Nitrate	R	R	R	R	R	R	R	-	-	-
Copper Sulfate	R	R	R	R	R	R	R	-	-	-
Dechlorinated Brine Storage	R	R	-	-	R	R	R	-	-	-
Esters, Fatty Acid	nr	nr	R	R	R	R	R	-	-	-
Ferric Chloride	R	R	R	R	R	R	R	-	-	-
Ferrous Chloride	R	R	R	R	R	R	R	-	-	-
Fluoboric Acid	R	R	R	120°	R	R	-	-	-	-
Fluosilicic Acid, Up to 10%	nr	nr	nr	nr	R	R	-	-	nr	nr
Fluosilicic Acid, Up to 32%	nr	nr	nr	nr	R	100°	-	-	-	-

1 1/4" System

1 3/16" System

Fiberglass System

Special Metals

PrimeAngle

Metal Grating

Roofwalk

Index



**CHEMICAL COMPATIBILITY TABLE**

Chemical	Series									
	E		P		V		PU		N	
	Rigid PVC		Poly/Glass		Vinyl/Glass		Poly		Nylon	
	70°	160°F	70°	160°F	70°	160°F	70°	160°F	70°	160°F
Formic Acid, Up to 10%	R	R	nr	nr	R	R	R	-	nr	nr
Formic Acid, Up to 50%	R	R	nr	nr	R	100°	R	-	-	-
Gasoline, Aviation	R	nr	R	nr	R	R	R	-	-	-
Green Liquor, Pulp Mill	R	R	-	-	R	R	-	-	-	-
Hydrochloric Acid, Up to 15%	R	R	R	nr	R	R	R	-	-	-
Hydrochloric Acid, Up to 37%	R	R	R	nr	R	R	R	-	-	-
Hydrofluoric Acid, Up to 10%	R	R	nr	nr	R	150°	-	-	-	-
Hydrofluoric Acid, Up to 20%	R	nr	nr	nr	R	100°	-	-	-	-
Hydrogen Chloride Wet Gas	nr	nr	R	nr	R	R	nr	-	-	-
Hydrogen Sulfide Wet Gas	R	R	R	nr	R	R	R	-	-	-
Lactic Acid	R	R	R	nr	R	R	R	-	-	-
Lead Nitrate	R	R	-	-	R	R	R	-	-	-
Magnesium Hydroxide	R	R	nr	nr	R	R	R	-	R	R
Nickel Sulfate	R	R	nr	nr	R	R	R	-	-	-
Nitric Acid, Up to 5%	R	R	nr	nr	R	150°	R	-	-	-
Nitric Acid, Up to 35%	R	R	nr	nr	R	150°	R	-	-	-
Nitric Acid, Vapor	R	R	nr	nr	R	R	R	-	-	-
Perchloric Acid, Up to 10%	nr	nr	nr	nr	R	150°	R	-	nr	nr
Pickling Liquids, 3-5% H2SO4	R	R	R	R	R	R	R	-	-	-
Phosphoric Acid	R	R	nr	nr	R	R	R	-	nr	nr
Super or Poly (115%, P20%)	R	R	nr	nr	R	R	R	-	-	-
Vapor or Condensate	R	R	nr	nr	R	R	R	-	-	-
Potassium Chloride	R	R	R	R	R	R	R	-	-	-
Potassium Nitrate	R	R	R	R	R	R	R	-	-	-
Potassium Persulfate	R	R	nr	nr	R	R	R	-	-	-
Silver Cyanide, Up to 5%	R	R	nr	nr	R	R	R	-	-	-
Sodium Hydroxide, Up to 25%	R	R	nr	nr	R	150°	R	-	-	-
Sodium Hydroxide, Up to 50%	R	R	nr	nr	R	180°	R	-	R	R
Sodium Hypochlorite, Up to 15%	R	R	nr	nr	R	150°	R	-	nr	nr
Sodium Nitrate	R	R	R	R	R	R	R	-	-	-
Sodium Sulfate	R	R	nr	nr	R	R	R	-	-	-
Sodium Sulfide	R	R	nr	nr	R	R	R	-	-	-
Sulfuric Acid, Up to 25%	R	R	R	R	R	R	R	-	nr	nr
Sulfuric Acid, Up to 70%	R	R	nr	nr	R	R	R	-	nr	nr
Sulfuric Acid, Up to 75%	nr	nr	nr	nr	R	120°	R	-	nr	nr
Sulfuric Acid, Up to 80%	nr	nr	nr	nr	nr	nr	nr	-	nr	nr
Sulfuric Acid, Vapor	R	R	R	nr	R	R	R	-	-	-
Trichlorethylene, Fumes	nr	nr	nr	nr	R	120°	R	-	-	-
Trisodium Phosphate	R	R	R	nr	R	R	R	-	-	-
Urea	R	R	R	nr	R	150°	R	-	R	R
Vegetable Oils	R	R	R	R	R	R	R	-	R	R
Vinegar	R	R	R	R	R	R	R	R	R	R
White Liquor, Pulp Mill	R	R	-	-	R	R	R	-	-	-

**Note**

The recommendations contained in this table are made without guarantee of representation as to results. Since the actual use by others is beyond our control, no guarantee, expressed or implied, is made by Unistrut as to effects of such use or results to be obtained nor does Unistrut assume any liability arising out of the use by others of the products referenced in this table. Nor is the information herein to be construed as absolutely complete since additional information may be needed or desirable when particular or exceptional conditions or circumstances exist or because of applicable laws or government regulations. We suggest that you evaluate these recommendations and suggestions in your own laboratory prior to use. Our responsibility for claims arising from breach of warranty, negligence, or otherwise is limited to the purchase price of the material.

**Legend**

- “nr” - “Not Recommended” for use
- “R” - “Recommended”
- “-” - no information available

1/4" System

13/16" System

Fiberglass System

Special Metals

PrimeAngle

Metal Grating

Roofwalk

Index

FIBERGLASS SPECIFICATIONS

1.0 SCOPE

- 1.1 This specification covers the requirements for the Unistrut Nonmetallic Channel Framing System.

2.0 MATERIAL

- 2.1 FRP channel shall be of pultruded glass-reinforced polyester or vinyl ester resin having the physical property values listed in this catalog.
- 2.2 Some accessories shall be of injection molded, 40% long glass fiber reinforced polyurethane, or nylon.

3.0 COMPOSITION

- 3.1 Glass-reinforced channel shall have a synthetic surfacing veil applied on exterior surfaces to improve weatherability and inhibit ultraviolet degradation. An ultraviolet stabilizer shall be incorporated in the resin formulation to further inhibit ultraviolet degradation.

4.0 STRUCTURAL DESIGN

- 4.1 Channel shall incorporate Unistrut's Aickinstrut flange profile design which allows full and positive interlocking contact of channel accessories and prohibits premature flange failure from torqued accessories.
- 4.2 Channel profile dimensions shall be:
  - 1 5/8" x 1 5/8" x 1/4" or
  - 1 1/2" x 1 1/8" x 1/8".
- 4.3 All 1 5/8" x 1 5/8" channel profiles shall have a minimum pull out resistance of 1,000 pounds when load is applied over a 3/8" long section of the inside flanges.
- 4.4 Channel section lengths shall be supplied in 10' or 20' lengths (±1/8").
- 4.5 Universal Pipe Clamps shall have full interlocking contact with interior channel flanges to maximize pull-out resistance and be adjustable to accommodate a minimum 3/4" variance in piping or conduit O.D. sizes.

5.0 STANDARDS

- 5.1 Glass-reinforced channels covered in this specification shall have a flame spread rating of 25 or less when tested per ASTM E84 and meet the requirements of UL 94V0 thereby qualifying them as Class 1 material in the Uniform Building Code.
- 5.2 Glass-reinforced channels covered in this specification shall comply with the requirements of ASTM D 3917 and ASTM D 4385 which govern the dimensional tolerance and visual defects of pultruded shapes.

6.0 GENERAL

- 6.1 Unistrut nonmetallic Channel Framing shall be furnished as a system which includes all the necessary fasteners, channel splice plates, brackets, sealants, hangers, pipe clamps, etc.
- 6.2 Nonmetallic fasteners shall be manufactured from long glass fiber reinforced polyurethane to ensure maximum strength and corrosion resistance.
- 6.3 All components of the Unistrut Channel Framing System shall be nonmetallic except where type 316 stainless steel hardware is used as part of the assembly.
- 6.4 The manufacturer shall not have had less than 10 years experience in manufacturing strut systems.
- 6.5 All products are manufactured in the United States of America.

1 1/4" System

1 3/16" System

Fiberglass System

Special Metals

PrimeAngle

Metal Grating

Roofwalk

Index

# SPECIAL METALS

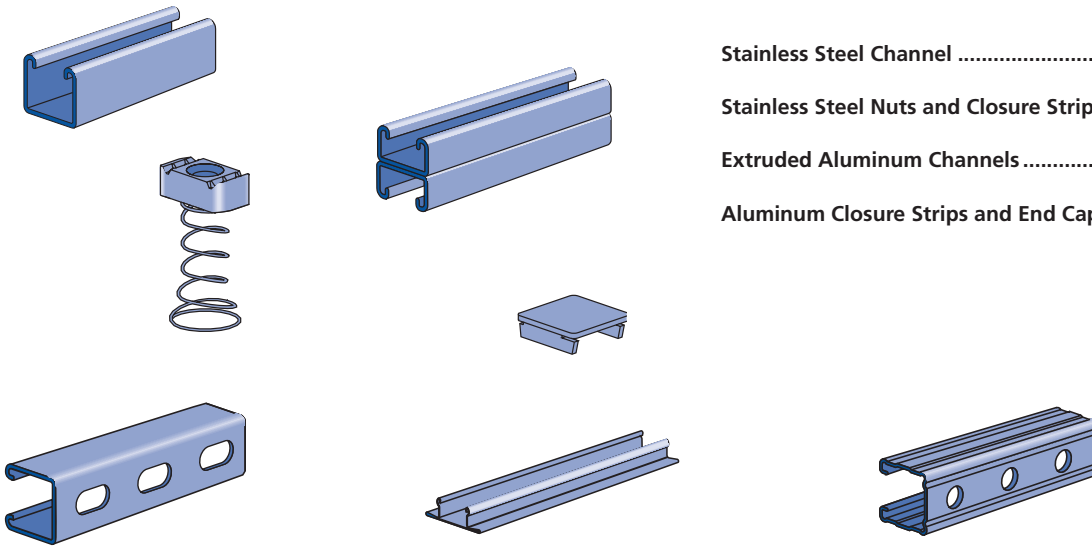

Stainless Steel Channel ..... 206

Stainless Steel Nuts and Closure Strips ..... 207

Extruded Aluminum Channels ..... 208 - 209

Aluminum Closure Strips and End Caps ..... 209

## MATERIAL

### STAINLESS STEEL

- Channels: ASTM A 240 (Type 304)
- Sintered nuts: ASTM B783 (Type SS316N1-25)
- Fittings:
  - ASTM A240 (Type 304 or Type 316) or ASTM A276 (Type 304 or Type 316)
  - Contact factory for specific material availability.

### ALUMINUM

- Channels (Extruded): ASTM B221 (Type 6063-T6)
- Fittings: ASTM B209 (Type 1100F or Type 5052-H32)
- Nuts: Stainless steel nuts are recommended for Aluminum channel

Material/Finish	Part Number Suffix	Example
Stainless Steel Type 304	SS	P1109 SS
Stainless Steel Type 316	ST	P1109 ST

## LOAD DATA (BEAM & COLUMN)

To determine maximum allowable beam and column loading for channels in this section, multiply the load data in the appropriate mild steel channel sections of this catalog by the following factors:

Channel Material	Beam Load % Factor	Column Load % Factor
Extruded Aluminum	33%	33%
Stainless Steel	100%	100%

## LOAD DATA (SLIP & PULL OUT)

## EXTRUDED ALUMINUM

To determine nut slip resistance, multiply load data for appropriate nut by 75%. To determine nut pull-out load, multiply load data for appropriate nut by 50%.

## STAINLESS STEEL

For design assistance, consult Unistrut customer engineering.

## PRODUCT AVAILABILITY

Most fittings and channels shown in this catalog, are available in aluminum or stainless steel. Consult factory for ordering information.

## DIMENSIONS

Imperial dimensions are illustrated in inches. Metric dimensions are shown in parenthesis or as noted. Unless noted, all metric dimensions are in millimeters and rounded to one decimal place.

**Special Metals Pictorial Index**

P1000 Series (12 gauge)



P1000 SS  
Pg 206



P1001 SS  
Pg 206

P1100 Series (14 gauge)



P1100 SS  
Pg 206



P1101 SS  
Pg 206

P3000 Series (12 gauge)



P3000 SS  
Pg 206

P3300 Series (12 gauge)



P3300 SS  
Pg 206



P3301 SS  
Pg 206

P4000 Series (16 gauge)



P4000 SS  
Pg 206

P6000 Series (19 gauge)



P6000 SS  
Pg 206

P7000 Series (19 gauge)



P7000 SS  
Pg 206

Closure Strips and End Caps



P3184 EA  
Pg 209



P1280 EA, P4280 EA,  
P5580 EA Pg 209

Stainless Steel Channel Nuts



P1006 - P1010  
Pg 207



P4006 - P4010  
Pg 207

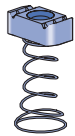

P5506 U - P5510U  
Pg 207



P4008UT  
Pg 207



A1006 SS, A1008 SS  
Pg 207



A4006 SS, A4008 SS  
Pg 207

Extruded Aluminum Channels



P1000 EA  
Pg 208



P1001 EA  
Pg 208



P4000 EA  
Pg 208



P4001 EA  
Pg 208

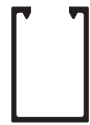

P5500 EA  
Pg 208



A1000 EA  
Pg 208



A4000 EA  
Pg 208



A4001 EA  
Pg 209



P6000 EA  
Pg 209



P6001 EA  
Pg 209



P7000 EA  
Pg 209



P7001 EA  
Pg 209

1/4" System

3/16" System

Fiberglass System

Special Metals

PrimeAngle

Metal Grating

Roofwalk

Index



1/4" System

**P1000 Series**

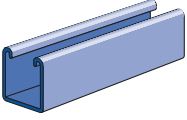
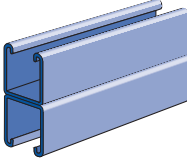
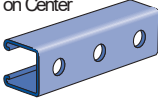
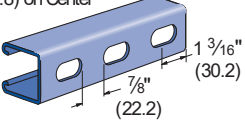
<p><b>P1000</b></p>  <p>W/100 Ft: 190 Lbs (283 kg/100m)</p>	<p><b>P1001</b></p>  <p>W/100 Ft: 380 Lbs (566 kg/100m)</p>	<p><b>P1000HS</b></p> <p>9/16" (14.3) Dia. Holes 1 7/8" (47.6) on Center</p>  <p>W/100 Ft: 185 Lbs (275 kg/100m)</p>	<p><b>P1000T</b></p> <p>Slots are 1 1/8" (28.6) x 9/16" (14.3) 2" (50.8) on Center</p>  <p>W/100 Ft: 185 Lbs (275 kg/100m)</p>
--	--	--	---

13/16" System

**P1100 Series**

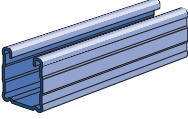
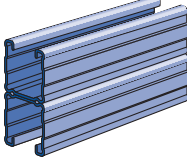
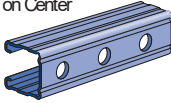
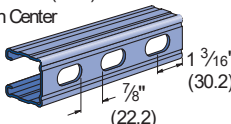
<p><b>P1100</b></p>  <p>W/100 Ft: 142 Lbs (211 kg/100m)</p>	<p><b>P1101</b></p>  <p>W/100 Ft: 284 Lbs (422 kg/100m)</p>	<p><b>P1100HS</b></p> <p>9/16" (14.3) Dia. Holes 1 7/8" (47.6) on Center</p>  <p>W/100 Ft: 136 Lbs (202 kg/100 m)</p>	<p><b>P1100T</b></p> <p>Slots are 1 1/8" (28.6) x 9/16" (14.3) 2" (50.8) on Center</p>  <p>W/100 Ft: 136 Lbs (202 kg/100m)</p>
--	--	---	---

Fiberglass System

**P3000 Series**

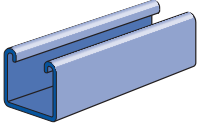
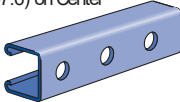
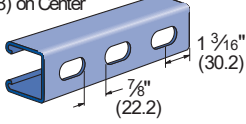
<p><b>P3000</b></p>  <p>W/100 Ft: 170 Lbs (253 kg/100m)</p>	<p><b>P3000HS</b></p> <p>9/16" (14.3) Dia. Holes 1 7/8" (47.6) on Center</p>  <p>W/100 Ft: 165 Lbs (112 kg/100m)</p>	<p><b>P3000T</b></p> <p>Slots are 1 1/8" (28.6) x 9/16" (14.3) 2" (50.8) on Center</p>  <p>W/100 Ft: 165 Lbs (112 kg/100m)</p>
---	--	---

Special Metals

**P3300 Series**

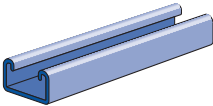
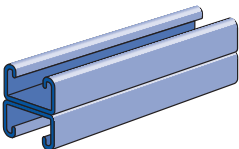
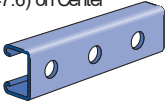
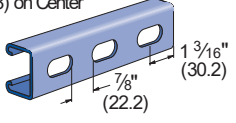
<p><b>P3300</b></p>  <p>W/100 Ft: 135 Lbs (201 kg/100m)</p>	<p><b>P3301</b></p>  <p>W/100 Ft: 270 Lbs (402 kg/100m)</p>	<p><b>P3300HS</b></p> <p>9/16" (14.3) Dia. Holes 1 7/8" (47.6) on Center</p>  <p>W/100 Ft: 130 Lbs (193 kg/100m)</p>	<p><b>P3300T</b></p> <p>Slots are 1 1/8" (28.6) x 9/16" (14.3) 2" (50.8) on Center</p>  <p>W/100 Ft: 130 Lbs (193 kg/100m)</p>
--	--	--	---

PrimeAngle

**P4000 Series**

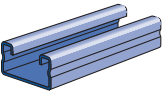
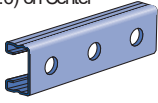
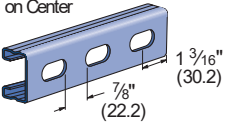
<p><b>P4000</b></p>  <p>W/100 Ft: 82 Lbs (122 kg/100m)</p>	<p><b>P4000HS</b></p> <p>9/16" (14.3) Dia. Holes 1 7/8" (47.6) on Center</p>  <p>W/100 Ft: 79 Lbs (110 kg/100m)</p>	<p><b>P4000T</b></p> <p>Slots are 1 1/8" (28.6) x 9/16" (14.3) 2" (50.8) on Center</p>  <p>W/100 Ft: 79 Lbs (110 kg/100m)</p>
---	---	--

Metal Grating

Roofwalk

<p><b>P6000</b></p>  <p>W/100 Ft: 37 Lbs (55 kg/100m)</p>	<p><b>P7000</b></p>  <p>W/100 Ft: 36 Lbs (54 kg/100m)</p>
--	--

Index

P1184

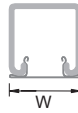
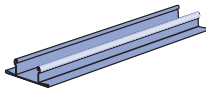

CLOSURE STRIP



Standard length 10 Ft.  
Material: Stainless steel type 304.

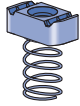

Part Number	Use With Channel	"W" In (mm)	Wt/100 Ft Lbs (kg/m)
P1184 SS	P1000		
	P1100	1 3/8	27
	P3300	41.3	40.2
	P4000		

CHANNEL NUT WITH SPRING – USE WITH 1/4" CHANNEL

	Part number	Nut Size Thread	Wt/100 pcs Lbs (kg)	Use With
	A1006-1420	1/4" -20	6 (2.7)	A1000
A1008	3/8" -16	6 (2.7)		
	Part number	Nut Size Thread	Wt/100 pcs Lbs (kg)	Use With
	A4008	3/8" -16	5 (2.3)	A3300, A4000

All Springs are Pre-Galvanized

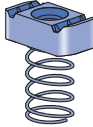
CHANNEL NUT WITH SPRING – USE WITH 1 3/8" CHANNEL

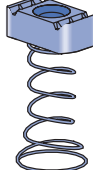
	Part number	Nut Size Thread	Wt/100 pcs Lbs (kg)	Use With 1 3/8" Channel
	P1006-1420*	1/4" 20	7 (3.2)	P1000, P1100, P2000, P3000, P4400
	P1008*	3/8" 16	10 (4.5)	
P1010*	1/2" 13	12 (5.4)		
	Part number	Nut Size Thread	Wt/100 pcs Lbs (kg)	Use With 1 3/8" Channel
	P4006-1420*	1/4" 20	7 (3.2)	P3300, P4000, P4100, P4520
	P4008*	3/8" 16	9 (4.1)	
P4010*	1/2" 13	9 (4.1)		
	Part number	Nut Size Thread	Wt/100 pcs Lbs (kg)	Use With 1 3/8" Channel
	P5506-1420*	1/4" 20	7 (3.2)	P5000, P5500
	P5508*	3/8" 16	10 (4.5)	
P5510*	1/2" 13	10 (4.5)		

CHANNEL NUT WITHOUT SPRINGS – USE WITH 1 3/8" CHANNEL

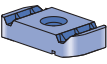
	Part number	Nut Size Thread	Wt/100 pcs Lbs (kg)	Use With 1 3/8" Channel
	P3006-1420 SS	1/4" 20	7 (3.2)	Any Channel
	P3008 SS	3/8" 16	10 (4.5)	
P3010 SS	1/2" 13	12 (5.4)	P1000, P1100, P2000, P3000	

\* Domestic stainless steel nuts are available. To designate a domestic part, insert a "U" as the sixth character in the part number. Ex: P3008U SS or P3010U SS

\* Domestic stainless steel nuts are available. To designate a domestic part, insert a "U" as the sixth character in the part number. Ex: P4006U 1420 SS or P1008U SS.

TOP SPRING CHANNEL NUTS – USE WITH 1 3/8" CHANNEL

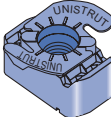
	Part number	Nut Size Thread	Wt/100 pcs Lbs (kg)	Use With 1 3/8" Channel
	P4008UT SS*	3/8" 16	12 (5.4)	P3300, P4000, P4100, P4400, P4520
	P1006TU1420SS*	1/4" -20	7 (3.2)	Any Channel
	P1008TU SS*	3/8" -16	10 (4.5)	
P1010TU SS*	1/2" -13	12 (5.4)	Any Channel Except P3300, P4000, P4400, P4520, P4100	

Top Spring stainless steel channel nuts are domestic

Note

Most fittings, as shown in this catalog are available in stainless steel or aluminum. It is recommended that stainless steel channel nuts be used with aluminum channels.



1/4" System

**P1000 EA**

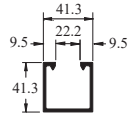
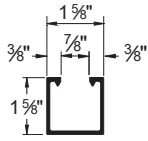

When used with P3184 EA.

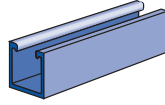

W/100 Ft: 76 Lbs (113 kg/100 m)  
Aluminum Type 6063-T6  
Nominal Thickness .109" (2.8mm)

13/16" System

**P1001 EA**

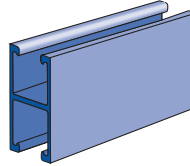
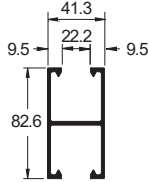
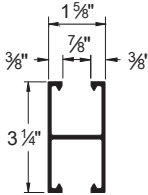

W/100 Ft: 134 Lbs (199 kg/100 m)  
Aluminum Type 6063-T6  
12 Gauge Nominal Thickness .109" (2.8mm)

Fiberglass System

**P4000 EA**

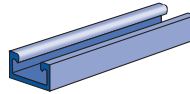
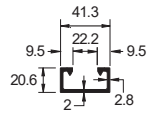
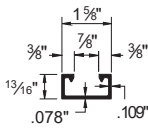

W/100 Ft: 45 Lbs (67 kg/100 m)  
Aluminum Type 6063-T6  
Nominal Thickness .078" (2.0mm)

Special Metals

**P4001 EA**

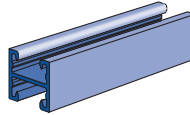
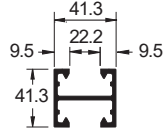
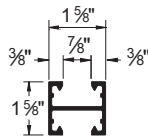

W/100 Ft: 66 Lbs (98 kg/100 m)  
Aluminum Type 6063-T6  
Nominal Thickness .078" (2.0mm)

PrimeAngle

**P5500 EA**

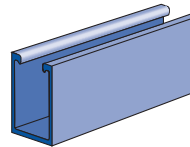
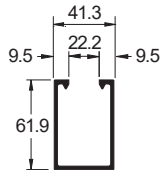
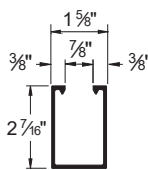

W/100 Ft: 97 Lbs (144 kg/100 m)  
Aluminum Type 6063-T6  
Nominal Thickness .109" (2.8mm)

Metal Grating

**A1000 EA**

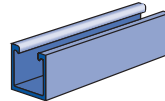
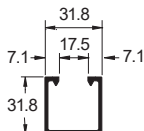
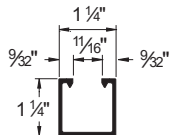

W/100 Ft: 40 Lbs (60 kg/100 m)  
Aluminum Type 6063-T6  
Nominal Thickness .075" (1.9mm)

Roofwalk

**A4000 EA**

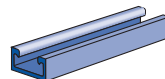
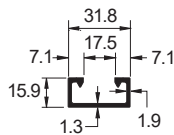
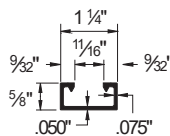

W/100 Ft: 25 Lbs (37 kg/100 m)  
Aluminum Type 6063-T6  
12 Gauge Nominal Thickness .050" (1.3mm)  
Standard Length 16 Ft.

Index



**A4001 EA**

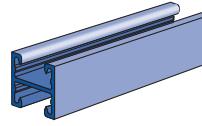
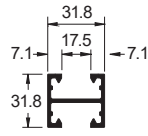
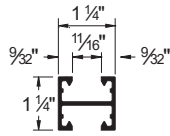

W/100 Ft: 40 Lbs (60 kg/100 m)  
Aluminum Type 6063-T6  
Nominal Thickness .078" (2.0mm)  
Standard Length 16 Ft.

**P6000 EA**

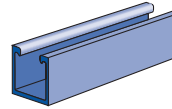
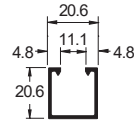
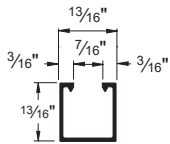

W/100 Ft: 12 Lbs (18 kg/100 m)  
Aluminum Type 6063-T6  
Nominal Thickness .040" (1.0mm)  
Standard Length 16 Ft.

**P6001 EA**

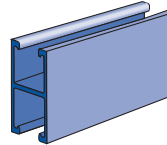
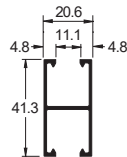
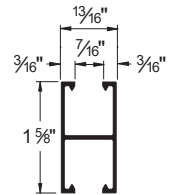

W/100 Ft: 20 Lbs (30 kg/100 m)  
Aluminum Type 6063-T6  
Nominal Thickness .040" (1.0mm)  
Standard Length 16 Ft.

**P7000 EA**

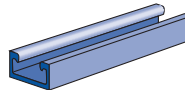
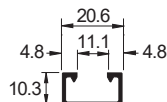
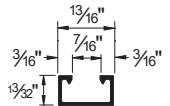

W/100 Ft: 9 Lbs (13 kg/100 m)  
Aluminum Type 6063-T6  
Nominal Thickness .040" (1.0mm)  
Standard Length 10 Ft.

**P7001 EA**

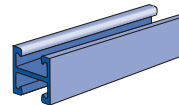
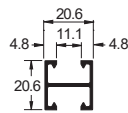
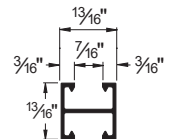

W/100 Ft: 17 Lbs (25 kg/100 m)  
Aluminum Type 6063-T6  
12 Gauge Nominal Thickness .040" (1.0mm)  
Standard Length 10 Ft

**P3184 EA**

**CLOSURE STRIP**

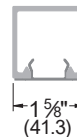
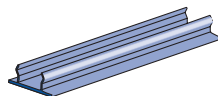

W/100 Ft: 21 Lbs (31 kg/100 m)  
Aluminum Type 6063-T6  
Standard Length 10 Ft

**P1280 EA, P4280 EA, P5580 EA**

**END CAPS**

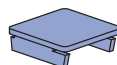

Part Number	Use With Channel	W/100 Ft Lbs(kg/m)
P1280 EA	P1000 EA	3.5 (1.6)
P4280 EA	P4000 EA	1.5 (0.7)
P5500 EA	P5500 EA	4.9 (2.2)

PrimeAngle™ .....	211
Accessories .....	212
PrimeAngle™ Technical Data .....	213 - 215

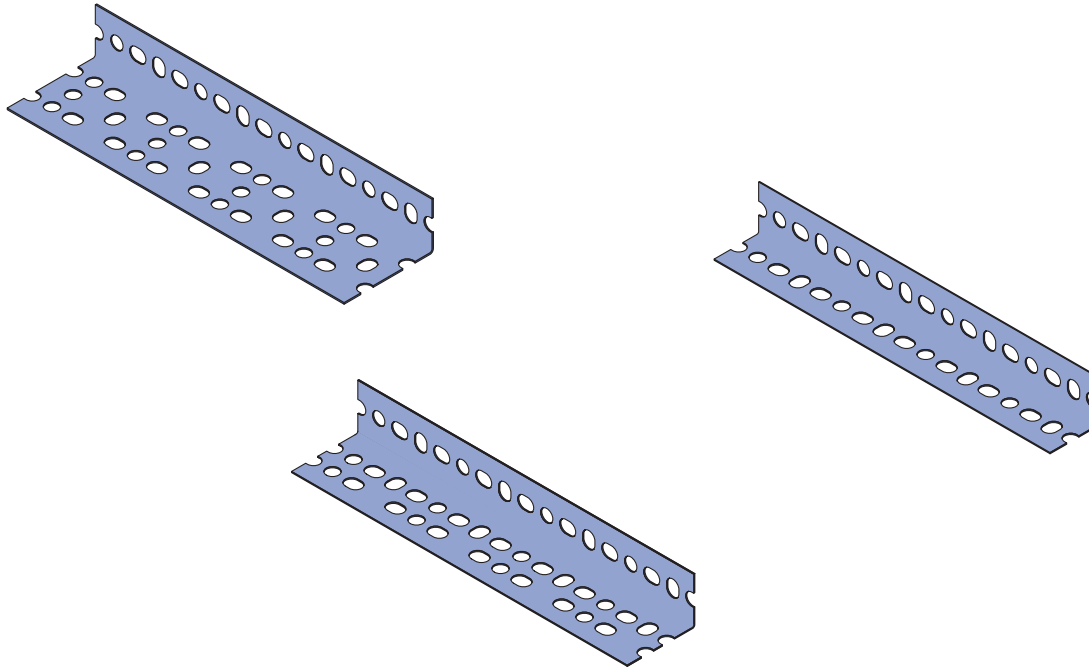

---

## MATERIAL

### STEEL: PLAIN

12 Gauge (.105" 1.0 mm) ASTM 1011 SS GR 33,  
14 Gauge (.076) ASTM 1011 SS GR 33

### STEEL: PRE-GALVANIZED

12 Gauge (.105" 1.0 mm) ASTM A653 GR 33,  
14 Gauge (.076) ASTM A653 GR 33

---

## FINISHES

Available in two durable, long-lasting finishes:

Pre-Galvanized (PG) or

Perma-Green III (GR) conforming to  
ASTM B633 Type III SC1.

---

## STANDARD LENGTHS

Standard lengths are 10' and 12'. Slotted angle is shipped in ten-piece bundles complete with 75 pieces of  $\frac{3}{8}$ " - 16 x  $\frac{3}{4}$ " hex head bolts and  $\frac{3}{8}$ " nuts.

---

## ORDERING INFORMATION:

When ordering, add the length or size and finish to the part number.

---

## DIMENSIONS

Imperial dimensions are illustrated in inches. Metric dimensions are shown in parenthesis or as noted. Unless noted, all metric dimensions are in millimeters and rounded to one decimal place.

PA 158

(1 5/8" x 1 5/8" x 14 GA.) LIGHT DUTY **PG**

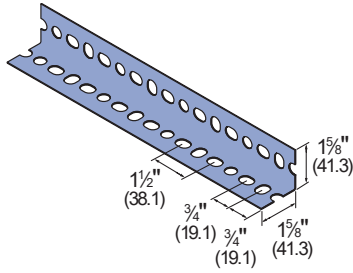

Note: Includes Serrated  
Nuts & Bolts

For those jobs where extra strength is not  
necessary. Ideal for light-duty shelving or  
racking.

W/100 Ft.: 66 lbs (29.9 kg)

PA 238

(1 5/8" x 2 3/8" x 14 GA.) MEDIUM DUTY **PG**

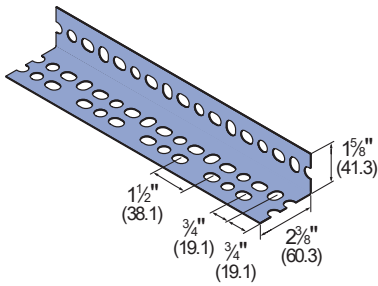

Note: Includes Serrated  
Nuts & Bolts

Perfect for the majority of framing  
needs, including shelving, racking and  
electrical or mechanical support jobs.

W/100 Ft.: 80 lbs(36.3 kg)

PA 318

(1 5/8" x 3 1/8" x 12 GA.) HEAVY DUTY

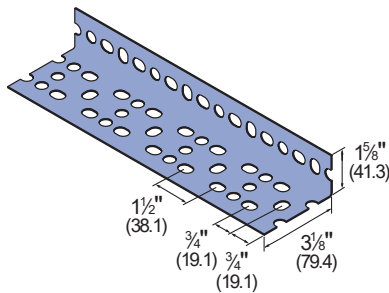

Note: Includes Serrated  
Nuts & Bolts

Suitable for balconies, ramps, large racks and  
shelving systems, as well as other structures  
with substantial load requirements.

W/100 Ft.: 130 lbs (59.0 kg)

1/4" System

3/16" System

Fiberglass System

Special Metals

PrimeAngle

Metal Grating

Roofwalk

Index

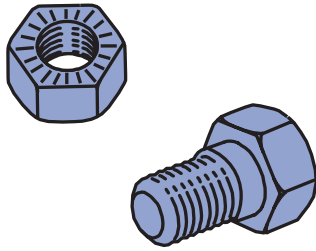

W/100 pcs: 7 lbs (3.2 kg)

**TRANSVERSE STIFFENERS**

When supporting concentrated loads, the capacity of a pair of slotted-angle beams can be increased by the addition of transverse stiffeners. These should be placed immediately under the load bearing point. The slotted-angle segment used as the stiffener is bolted into place using a metal connector at each junction.

Beams that are 6' (182.9 cm) long or less require only one stiffener in the center of the span. Seven-foot beams need two stiffeners placed 2' (61.0 cm) from each end. Eight-foot beams require two stiffeners 2'6" (76.2 cm) from the ends. For beams with a nine-foot span, it is necessary to have three stiffeners at 2'3" (68.6 cm) intervals. Ten-foot beams need three stiffeners with 2'6" spacings.

For maximum effectiveness, transverse stiffeners should never be spaced more than 3'6" (106.7 cm) apart.

Note: All loads based on actual physical testing. Documentation available on request.

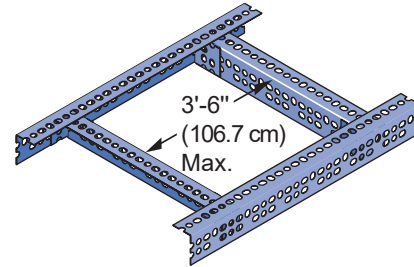

## BEAM CONFIGURATIONS

(See corresponding letters in table on following page for load data)

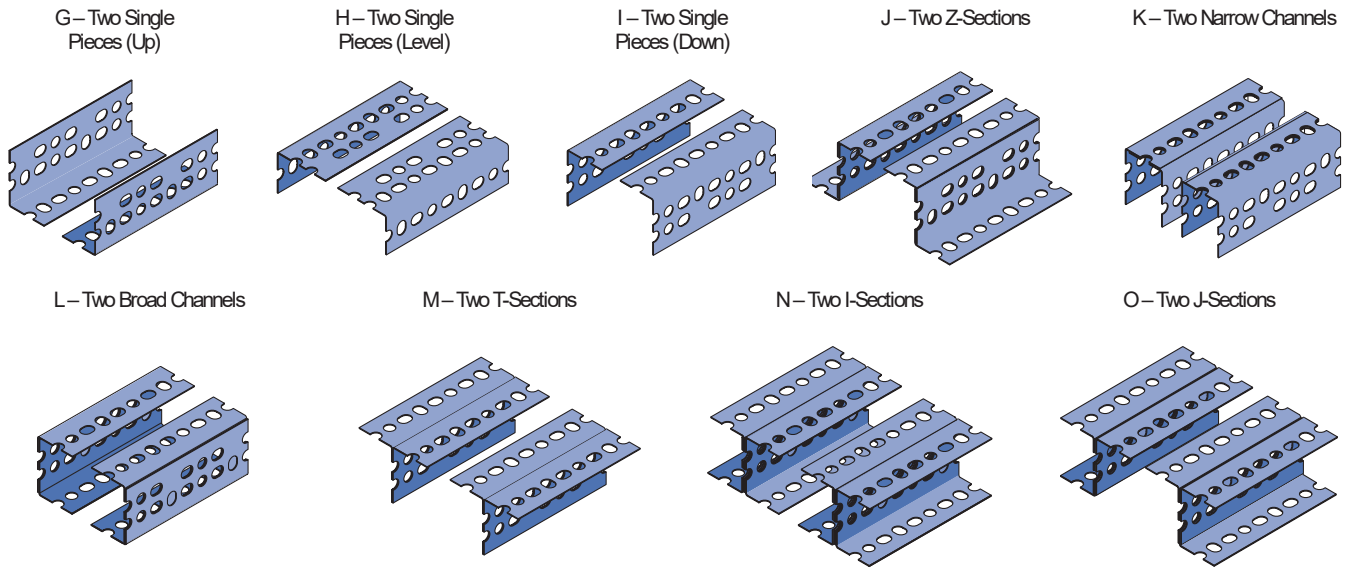

## BEAM CONFIGURATIONS WITH STIFFENERS

(See corresponding letters in table on following page for load data)

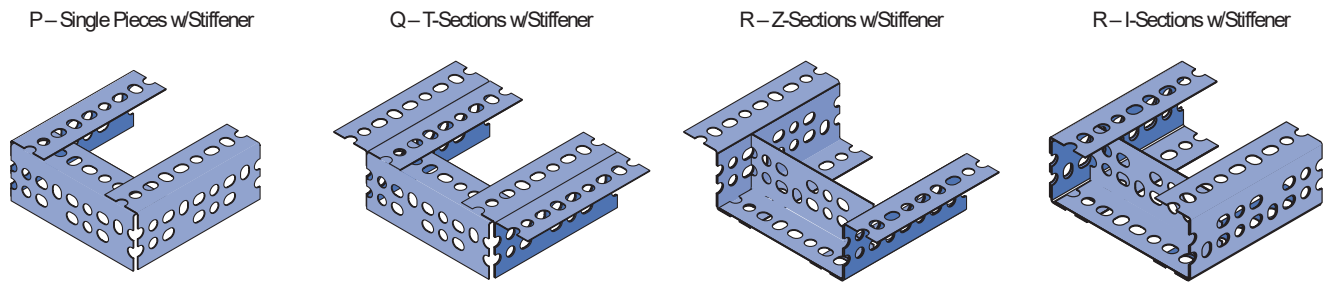

## BEAM LOAD CALCULATIONS

The beam loading depends on which slotted angle is used and the manner in which the beam is constructed. The diagrams above show how individual slotted angle components can be combined to form a beam. The loading for each beam configuration is shown in the beam loading tables on the next page.

### Example - Load "A"

Load "A" is supported by two 48" (121.9 cm) sections of PA-238 (1 5/8" x 2 3/8") (41.3mm x 60.3mm). The 48" row in the PA 238 table on next page indicates what each beam configuration will support. Since the columns are sorted from lowest to highest load, the first configuration that satisfies the requirement is "J" which will support 1,100 lbs (4.9 kN).

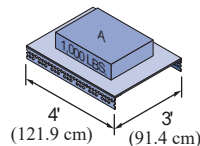

### Example - Load "B"

Load "B" is supported by two 36" (91.4 cm) sections of PA-238 (1 5/8" x 2 3/8") (41.3mm x 60.3mm). The 36" row in the PA 238 table on next page indicates what each beam configuration will support. Since the columns are sorted from lowest to highest load, the first configuration that satisfies the requirement is "J" which will support 1,100 lbs (4.9 kN).

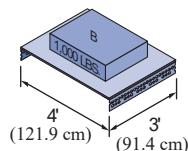

### Example - Load "C"

Load "C" is supported by all four beam sections. The load is distributed uniformly on two 3' (91.4 cm) and two 4' (121.9 cm) beams which total 14' (426.7 cm) of supporting beam length. Dividing the 1,000 lbs. (4.5 kN) load by 14-feet equals 72 lbs. per foot (106.3 kg per meter). Using the two 4' (121.9 cm) longest (weakest) lengths, calculate the total weight as follows:

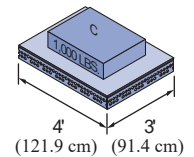

$$2 \text{ (beams)} \times 4' \text{ (length)} \times 72 \text{ lbs./ft.} = 576 \text{ lbs. total wt.}$$

$$2 \text{ (beams)} \times 121.9 \text{ cm (length)} \times 106.3 \text{ kg/M} = 25,915 \text{ kg total wt.}$$

The 36" (91.4 cm) row in the PA 238 table on next page indicates what each beam configuration will support. Since the columns are sorted from lowest to highest load, the first configuration that satisfies the requirement is "J" which will support 830 lbs. (3.7 kN) and is adequate for this requirement. The 3-foot beams configured in the same manner will support the load because they are shorter and stronger.



**BEAM LOADS**

(See corresponding letters in table on previous page for configurations)

**PA 158**

**LIGHT DUTY, (1 1/8" x 1 1/8" x 14 GA.)**

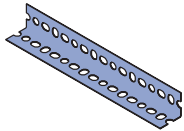

Span In. (cm)	G Lbs (kN)	H Lbs (kN)	I Lbs (kN)	P Lbs (kN)	L Lbs (kN)	R Lbs (kN)	M Lbs (kN)
24	550	830	830	920	1,600	1,700	1,840
61.0	2.45	3.69	3.69	4.09	7.12	7.56	8.18
36	370	560	560	610	1,070	1,130	1,230
91.4	1.65	2.49	2.49	2.71	4.76	5.03	5.47
48	280	420	420	460	800	850	920
121.9	1.25	1.87	1.87	2.05	3.56	3.78	4.09
60	220	330	330	370	640	680	740
152.4	0.98	1.47	1.47	1.65	2.85	3.02	3.29
72	180	280	280	310	530	570	610
182.9	0.80	1.25	1.25	1.38	2.36	2.54	2.71
84	•	240	240	260	460	490	530
213.4	•	1.07	1.07	1.16	2.05	2.18	2.36
96	•	210	210	230	400	430	460
243.8	•	0.93	0.93	1.02	1.78	1.91	2.05
108	•	•	•	•	360	380	410
274.3	•	•	•	•	1.60	1.69	1.82
120	•	•	•	•	320	340	370
304.8	•	•	•	•	1.42	1.51	1.65

**PA 238**

**MEDIUM DUTY, (1 1/8" x 2 3/8" x 14 GA.)**

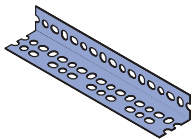

Span In. (cm)	G Lbs (kN)	H Lbs (kN)	I Lbs (kN)	P Lbs (kN)	J Lbs (kN)	L Lbs (kN)	R Lbs (kN)	M Lbs (kN)	K Lbs (kN)	Q Lbs (kN)	O Lbs (kN)	N Lbs (kN)
24	700	1,020	1,660	1,740	2,220	3,170	3,230	3,490	3,590	3,630	6,060	7,560
61.0	3.11	4.54	7.38	7.74	9.88	14.10	14.37	15.52	15.97	16.15	26.96	33.63
36	460	680	1,100	1,160	1,480	2,110	2,150	2,320	2,390	2,420	4,040	5,040
91.4	2.05	3.02	4.89	5.16	6.58	9.39	9.56	10.32	10.63	10.76	17.97	22.42
48	350	510	830	870	1,110	1,580	1,620	1,740	1,800	1,810	3,030	3,780
121.9	1.56	2.27	3.69	3.87	4.94	7.03	7.21	7.74	8.01	8.05	13.48	16.81
60	280	410	660	700	890	1,270	1,290	1,390	1,440	1,450	2,420	3,020
152.4	1.25	1.82	2.94	3.11	3.96	5.65	5.74	6.18	6.41	6.45	10.76	13.43
72	230	340	550	580	740	1,060	1,080	1,160	1,200	1,210	2,020	2,520
182.9	1.02	1.51	2.45	2.58	3.29	4.72	4.80	5.16	5.34	5.38	8.99	11.21
84	•	290	470	500	630	910	920	1,000	1,030	1,040	1,730	2,160
213.4	•	1.29	2.09	2.22	2.80	4.05	4.09	4.45	4.58	4.63	7.70	9.61
96	•	260	410	440	550	790	810	870	900	910	1,520	1,890
243.8	•	1.16	1.82	1.96	2.45	3.51	3.60	3.87	4.00	4.05	6.76	8.41
108	•	•	•	•	490	700	720	770	800	810	1,350	1,680
274.3	•	•	•	•	2.18	3.11	3.20	3.43	3.56	3.60	6.01	7.47
120	•	•	•	•	440	630	650	700	720	730	1,210	1,510
304.8	•	•	•	•	1.96	2.80	2.89	3.11	3.20	3.25	5.38	6.72

**PA 318**

**HEAVY DUTY, (1 1/8" x 3 1/8" x 12 GA.)**

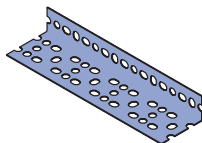

Span In. (cm)	G Lbs (kN)	H Lbs (kN)	I Lbs (kN)	P Lbs (kN)	J Lbs (kN)	L Lbs (kN)	R Lbs (kN)	M Lbs (kN)	K Lbs (kN)	Q Lbs (kN)	O Lbs (kg)	N Lbs (kg)
24	1,790	1,610	4,300	4,960	6,520	7,910	8,070	9,920	9,990	10,170	14,600	16,120
61.0	7.96	7.16	19.13	22.06	29.00	35.19	35.90	44.13	44.44	45.24	64.94	71.71
36	1,200	1,070	2,870	3,310	4,350	5,270	5,380	6,610	6,660	6,780	9,730	10,750
91.4	5.34	4.76	12.77	14.72	19.35	23.44	23.93	29.40	29.63	30.16	43.28	47.82
48	900	810	2,150	2,480	3,260	3,950	4,030	4,960	4,990	5,080	7,300	8,060
121.9	4.00	3.60	9.56	11.03	14.50	17.57	17.93	22.06	22.20	22.60	32.47	35.85
60	720	640	1,720	1,980	2,610	3,160	3,230	3,970	4,000	4,070	5,840	6,450
152.4	3.20	2.85	7.65	8.81	11.61	14.06	14.37	17.66	17.79	18.10	25.98	28.69
72	600	540	1,430	1,650	2,170	2,640	2,690	3,310	3,330	3,390	4,870	5,370
182.9	2.67	2.40	6.36	7.34	9.65	11.74	11.97	14.72	14.81	15.08	21.66	23.89
84	•	460	1,230	1,420	1,860	2,260	2,300	2,830	2,850	2,910	4,170	4,610
213.4	•	2.05	5.47	6.32	8.27	10.05	10.23	12.59	12.68	12.94	18.55	20.51
96	•	400	1,080	1,240	1,630	1,980	2,020	2,480	2,500	2,540	3,650	4,030
243.8	•	1.78	4.80	5.52	7.25	8.81	8.99	11.03	11.12	11.30	16.24	17.93
108	•	•	•	1,100	1,450	1,760	1,790	2,200	2,220	2,260	3,240	3,580
274.3	•	•	•	4.89	6.45	7.83	7.96	9.79	9.88	10.05	14.41	15.92
120	•	•	•	990	1,300	1,580	1,610	1,980	2,000	2,030	2,920	3,220
304.8	•	•	•	4.40	5.78	7.03	7.16	8.81	8.90	9.03	12.99	14.32

1 1/4" System

1 3/16" System

Fiberglass System

Special Metals

PrimeAngle

Metal Grating

Roofwalk

Index

**PrimeAngle Column Loads**

**COLUMN LOADS**

Column sections are calculated as described in the following example: (Assumes use of PA-238 1 5/8" x 2 3/8"(41.3mm x 60.3mm), material.)

Since all load areas are supported equally by the 4-columns, the calculations are based on a single-column section.

Section MN is one-fourth of "X", or 250 pounds (1.1 kN). Column section NP supports one-fourth of "Y" (250 pounds) plus the load supported by MN, or a total of 500 pounds (2.2 kN). Section PQ supports one-fourth of "Z" (250 pounds) plus the 500 pound load on section NP, or a total of 750 (3.3kN) pounds.

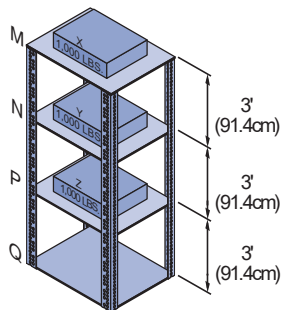

Column loads are based on free and unbraced column lengths. Since MN, NP and PQ are each 3' long, the load requirement is for a 36" section that will bear 750 pounds safely. A reference to the PA 238 table to the right indicates that all sections designated "A" will support 2,280 lbs. (10.1 kN) and meet the necessary requirements.

Note: To simplify assembly, we recommend using the same size material as for the horizontal members. This would be found in Table 2 to match the 14 gauge 1 5/8" x 2 3/8" (41.3mm x 60.3mm) material selected for the beams of this structure.

A – Single Piece

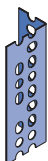

B – T-Section

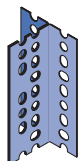

B – Broad Channel Section

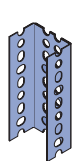

B – Narrow Channel Section

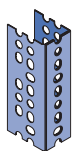

C – Uneven T-Section

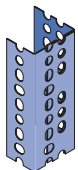

C – Uneven Channel Section

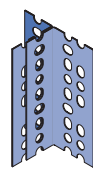

D – Dual Channel Section

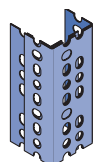

D – T-Channel Section



D – T-Channel Section



E – I-Section

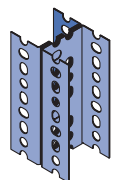

F – Uneven I-Section

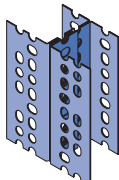

**PA 158**

(1 5/8" x 1 5/8" x 14 GA.)

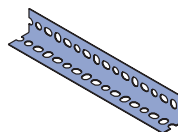

Span In. (cm)	A Lbs (kN)	B Lbs (kN)
36	1,450	3,850
91.4	6.45	17.13
48	1,150	3,500
121.9	5.12	15.57
60	950	3,000
152.4	4.23	13.34
72	750	2,500
182.9	3.34	11.12

**PA 238**

(1 5/8" x 2 3/8" x 14 GA.)

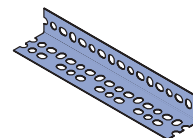

Span In. (cm)	A Lbs (kN)	B Lbs (kN)	C Lbs (kN)	D Lbs (kN)	E Lbs (kN)	F Lbs (kN)
36	2,280	4,760	4,940	7,270	9,520	9,865
91.4	10.14	21.17	21.97	32.34	42.35	43.88
48	1,970	4,490	4,680	6,920	8,970	9,330
121.9	8.76	19.97	20.82	30.78	39.90	41.50
60	1,520	3,995	4,310	6,370	7,990	8,620
152.4	6.76	17.77	19.17	28.34	35.54	38.34
72	1,070	3,140	3,870	5,840	6,280	7,715
182.9	4.76	13.97	17.21	25.98	27.93	34.32
84	660	2,340	3,665	4,930	4,660	6,740
213.4	2.94	10.41	16.30	21.93	20.73	29.98
96	.	1,750	2,700	3,850	3,500	5,365
243.8	.	7.78	12.01	17.13	15.57	23.86
108	.	.	2,060	2,870	.	4,115
274.3	.	.	9.16	12.77	.	18.30
120	.	.	1,610	2,690	.	3,210
304.8	.	.	7.16	11.97	.	14.28

**PA 318**

(1 5/8" x 3 1/8" x 12 GA.)

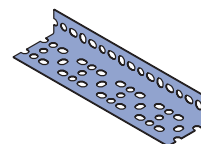

Span In. (cm)	A Lbs (kN)	B Lbs (kN)	C Lbs (kN)	D Lbs (kN)	E Lbs (kN)	F Lbs (kN)
36	3,470	7,970	8,770	12,560	15,940	17,550
91.4	15.44	35.45	39.01	55.87	70.90	78.07
48	2,870	7,360	8,580	11,970	14,750	17,150
121.9	12.77	32.74	38.17	53.25	65.61	76.29
60	1,970	6,570	8,180	11,360	13,160	16,360
152.4	8.76	29.22	36.39	50.53	58.54	72.77
72	1,280	5,270	7,690	10,480	10,560	15,360
182.9	5.69	23.44	34.21	46.62	46.97	68.32
84	.	3,670	6,970	9,470	7,370	13,970
213.3	.	16.32	31.00	42.12	32.78	62.14
96	.	2,580	6,260	8,370	5,170	12,570
243.8	.	11.48	27.85	37.23	23.00	55.91
108	.	.	5,460	6,880	.	10,970
274.3	.	.	24.29	30.60	.	48.80
120	.	.	4,460	5,370	.	8,960
304.8	.	.	19.84	23.89	.	39.86

1/4" System

3/16" System

Fiberglass System

Special Metals

PrimeAngle

Metal Grating

Roofwalk

Index

# UNITED INTERLOCK® GRATING

United Interlock Plank Grating System from Unistrut, commonly known as Interlock Grating, fills a multitude of needs including flooring and walkways, mezzanines, stair treads, maintenance and staging platforms, scaffolding planks, architectural wall coverings and more. United Interlock Grating Systems meets your needs for strength, durability, safety and aesthetics.



Customers choose United Interlock Grating Systems for many reasons:

- Cost-effectiveness
- Easy-to-install product
- Quality assurance that comes from extensive load testing
- Strong design look of our plank grating

## United Interlock Grating Applications include:

- Architectural wall coverings
- Catwalks, walkways and pedestrian ramps
- Maintenance and inspection walkways
- Ventilation covers for tanks and wells
- Mining and quarry tower decking
- Pumping and drilling platforms
- Subflooring
- Mezzanines
- Shelving
- Stairs



Ease of Installation .....	217
Plank Grating .....	218 - 219
Accessories .....	220 - 222
Heavy Duty Stair Treads .....	223
Design and Testing .....	224
Plank Loads and Deflections .....	225 - 230
Architectural Specifications.....	231



## Architectural Applications

Interlock Grating provides a functional and aesthetically appealing look to architectural applications. Aluminum gratings resist corrosion to give walls, ceilings, ledges, trim, flooring, and specialty projects a clean, lasting, high-tech look.

Interlocking plank grating works especially well in intensive-use areas. In addition to its durability, it is easy to clean and does not reflect sound like a solid surface.

Architects have often selected Interlock Grating because it protects lights, insulation support columns, wiring, and other fixtures. And, the panels allow authorized personnel to access the fixtures.



## Ease of Installation

Contractors have reported installed cost savings of up to 75% with Interlock Grating. Many factors combine to make installation quick and easy:

- 1) The lightweight grating is easy to handle. One person can carry a 24' plank.
- 2) Interlock Grating is easy to install with a minimal number of laborers.
- 3) Interlock Grating's light weight reduces shipping costs.
- 4) The planks interlock with positive friction, eliminating costly welding and bolting in some cases.
- 5) Field modifications are easy. Interlock Grating can be cut to size, shape, and angle at the jobsite.
- 6) Interlock Grating requires fewer support structures.



1 1/4" System

1 9/16" System

Fiberglass System

Special Metals

PrimeAngle

Metal Grating

Roofwalk

Index



United Interlock Grating strength-to-weight ratio allows it to withstand substantial loads while being easy to handle. The male-female legs of the roll-formed grating interlock securely, and double-male legs provide a safe finished edge for end planks.

Two standard surfaces are available: slotted-smooth and anti-skid. Anti-skid is the ideal choice when safe walking conditions are important. Die-formed teeth in the transverse ribs give you 360° of shoe-gripping traction even when the grating is wet, oily, muddy, or icy.



## Interlock Grating Features

### Maximizes performance and safety...

- Anti-skid surface provides 360° of slip resistance
- All sections made from structural-grade steel
- Roll-formed design provides superior strength
- Optional heel-toe side and end plates
- Open design prevents build-up of water, grease, oil and small debris

### And gives you complete project versatility.

- 6", 9" and 12" plank widths allow design in 3" increments
- Standard lengths of 20' and 24', and special lengths up to 30', provide excellent design flexibility
- Choice of smooth punched, anti-skid punched or solid unpunched surfaces
- Four leg heights, and two material gauges meet a wide range of load, space and budget requirements

Punched Interlock Grating has an open area of 43% for 12" grating, 42% for 9" grating and 35% for 6" grating. This prevents dirt, debris, ice, and snow from building up on the surface and allows light and air to pass through. United Interlock steel grating is made from pre-galvanized steel which conforms to a G-90 thickness designation per ASTM A653. The aluminum grating is made from type 5052 aluminum with a thickness of 0.080".

Unpunched smooth surface grating is also available for special applications.

United Interlock Grating Systems are strong, economical, versatile, and easy to specify.

### Variety of choices

- 6" and 9" standard-duty width
- 12" light-duty width
- 14 gauge and 18 gauge
- 1 1/2", 2 1/2", 3" (12" width only) and 4" (6" and 9" width only) leg heights
- 20' and 24' stock lengths
- Anti-skid, slotted-smooth punched surfaces and solid unpunched surface
- Double male and male-female leg shapes
- Steel (6", 9" or 12") and aluminum (6" or 9")



**Plank Grating**

**UNITED INTERLOCK® GRATING SYSTEMS—6" AND 9"**

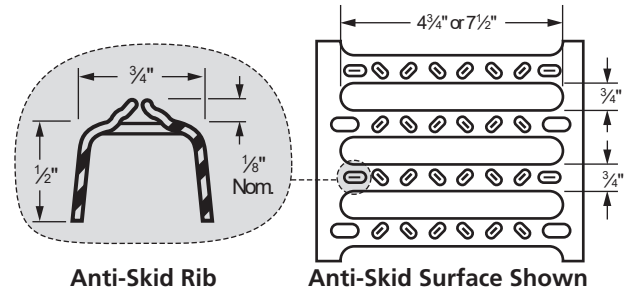
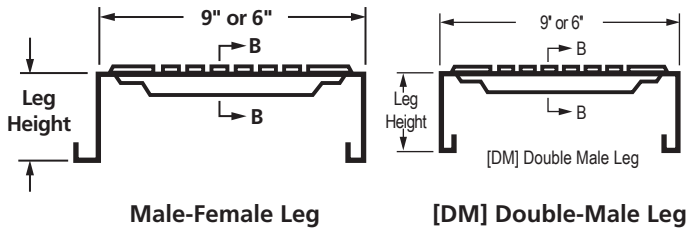

6" Wide Planks (14 Ga, 18 Ga, 0.080 Aluminum)							
Leg Height	Leg Shape	Finish Material	Slotted, Smooth	Anti-Skid	Un-punched	Wt. Lbs./Ft	Wt. Lbs./Ft <sup>2</sup>
1 1/2"	DM	PG	G61141	G61142	G61143	2.7	5.4
	MF	14 Ga.	G62141	G62142	G62143	2.7	5.4
2 1/2"	DM	PG	G61241	G61242	G61243	3.4	6.8
	MF	14 Ga.	G62241	G62242	G62243	3.4	6.8
	DM	PG	G61281	G61282	G61283	2.2	4.4
	MF	18 Ga.	G62281	G62282	G62283	2.2	4.4
	DM	AL	G61221	G61222	G61223	1.2	2.3
	MF	0.080"	G62221	G62222	G62223	1.2	2.3
4"	DM	PG	G61341	G61342	G61343	4.2	8.4
	MF	14 Ga.	G62341	G62342	G62343	4.2	8.4

9" Wide Planks (14 Ga, 18 Ga, 0.080 Aluminum)							
Leg Height	Leg Shape	Finish Material	Slotted, Smooth	Anti-Skid	Un-punched	Wt. Lbs./Ft	Wt. Lbs./Ft <sup>2</sup>
1 1/2"	DM	PG	G91141	G91142	G91143	3.5	4.7
	MF	14 Ga.	G92141	G92142	G92143	3.5	4.7
2 1/2"	DM	PG	G91241	G91242	G91243	4.0	5.3
	MF	14 Ga.	G92241	G92242	G92243	4.0	5.3
	DM	PG	G91281	G91282	G91283	2.7	3.6
	MF	18 Ga.	G92281	G92282	G92283	2.7	3.6
	DM	AL	G91221	G91222	G91223	1.5	2.0
	MF	0.080"	G92221	G92222	G92223	1.5	2.0
4"	DM	PG	G91341	G91342	G91343	4.8	6.4
	MF	14 Ga.	G92341	G92342	G92343	4.8	6.4

Note: Standard grating lengths are 20' or 24'; DM-Double Male, MF-Male-Female  
Unpunched smooth surface grating is also available for special applications. Contact Unistrut for more information.

**UNITED INTERLOCK® GRATING SYSTEMS—12"**

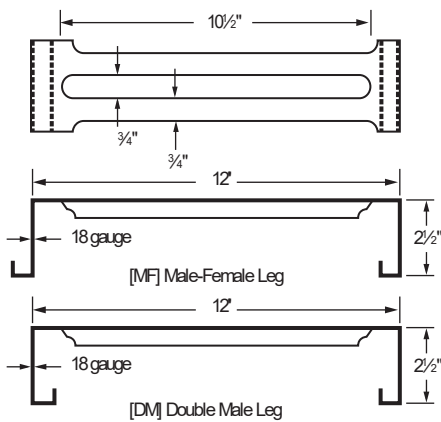

12" Wide Planks, 18 Gauge				
Leg Height	Leg Shape	Finish Material	Slotted, Smooth	Anti-Skid
2 1/2"	DM	PG 18 Gauge	G 11281	G 11282
3"	DM	PG 18 Gauge	G 11583	Contact Factory

**For Light Traffic Applications**

Ideal for mezzanines and other large-area applications, extra-wide 12" interlocking plank grating is designed to simplify installation and reduce the cost of mezzanines, flooring, decking, staging platforms, Roofwalks® and similar applications. With a 43% open area, it allows water, light and air to pass through.

With its extra width, Unistrut 12" wide plank grating covers more area with fewer planks, lowering installation costs. Its high strength-to-weight ratio—18 gauge, 2 1/2" and 3" leg height—makes it ideal for covering large, light-traffic areas. Its snap-together friction fit make it easy to install, with no welding or bolting required.

Made of pre-galvanized steel, it's maintenance-free and long lasting. Specifiers can choose a smooth or anti-skid surface to meet a wide variety of application needs.

1 1/4" System

1 9/16" System

Fiberglass System

Special Metals

PrimeAngle

Metal Grating

Roofwalk

Index



**FILLER PANEL**

1 1/4" System

1 3/16" System

Fiberglass System

Special Metals

PrimeAngle

Metal Grating

Roofwalk

Index



Part No.*	Description
G31183 PG	3" Wide x 1 1/2" Leg Height
G31283 PG	3" Wide x 2 1/2" Leg Height
G31383 PG	3" Wide x 4" Leg Height

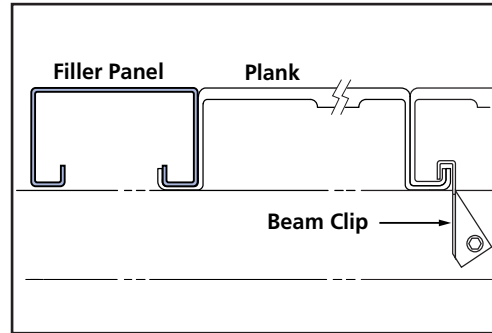

Provided in standard lengths of 10' and 12'.

**CARRIER PLATE**



Part No.*	Description
G603 PG	10 ga.- for 9" wide heavy duty stair treads ( 3/16" hole and 1 1/2" x 3/16" slot)
G618 PG	10 ga. for 10 1/2" wide stair treads ( 3/16" hole and 1 1/2" x 3/16" slot)
G642 PG	10 ga. for 11" wide stair treads ( 3/16" hole and 1 1/2" x 3/16" slot)

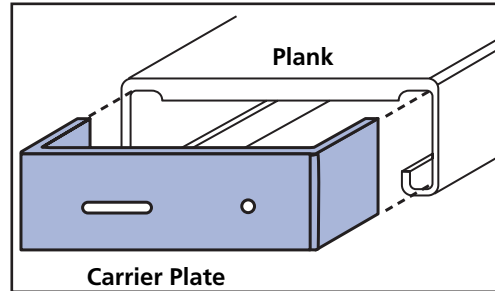

Provides easy attachment of stair treads to support structures and stringers.

**HEEL/TOE SIDE PLATES – 6 1/2" AND 8" HEIGHTS**



Part No.*	Description
G631 PG*	14 ga. x 6 1/2" high x 24' long
G621 PG	14 ga. x 8" high x 12' long

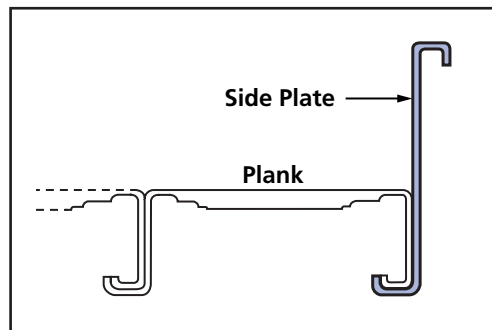

Forms a curb along grating length that defines a structure's side edge, and helps contain loose objects.

\*Part numbers shown are for galvanized. Most accessories are also available in aluminum.

**Accessories**

**HEEL/TOE END PLATES – 6½" AND 8" HEIGHTS**

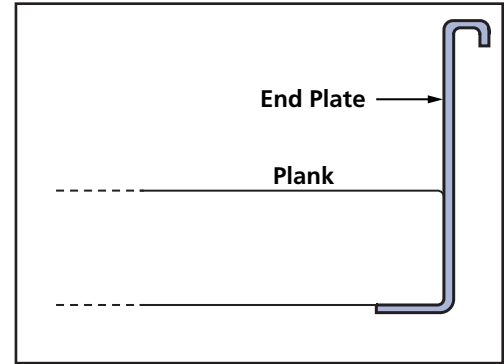

Part No.*	Description
G622 PG	14 ga. x 6½" high x 12' long
G623 PG	14 ga. x 8" high x 12' long

Forms a curb along grating ends that defines a structure's edge, and helps contain loose objects.

**HOLD DOWN CLIP**



Part No.	Description
G639 PG	1½" leg height
G607 PG*	2½" leg height
G620 PG	4" leg height

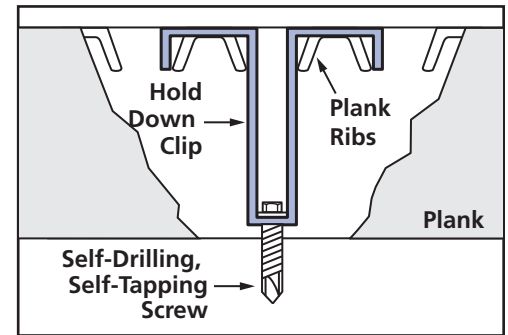

A 16 gauge attachment for fastening grating to support structure below. Attaches through top side of grating.

**"J" BOLT/NUT LOCK WASHER**



Part No.*	Description
G600 EG	5/16" x 2½"

Attachment for fastening panels to supporting members from underside of grating.

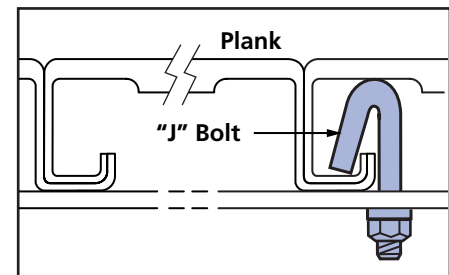

\*Part numbers shown are for galvanized. Most accessories are also available in aluminum.



1 1/4" System

1 3/16" System

Fiberglass System

Special Metals

PrimeAngle

Metal Grating

Roofwalk

Index

**GRATING BEAM CLAMP**



Part No.*	Description
G640 EG	Beam clamp

Attaches grating to structural I-beams.  
Requires no welding or drilling.

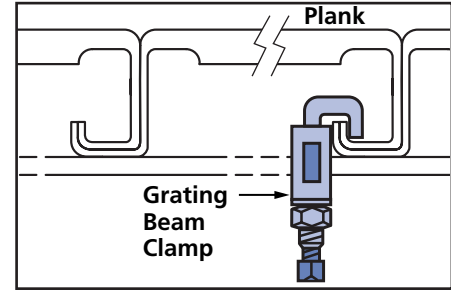

**LIGHT GAUGE BEAM CLIP**



Part No.*	Description
G124 EG	Light Gauge Beam Clip

Quickly attaches grating to rack or shelving beams.  
Requires self-drilling, self-tapping screw—GHTS 012075 EG (not included).

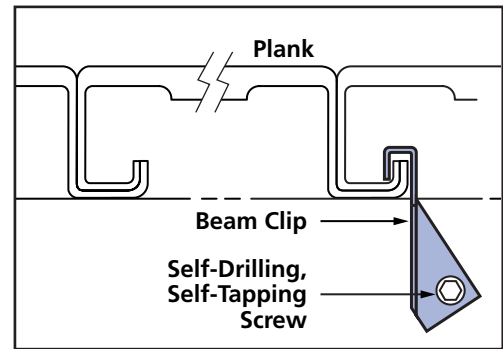

**RECESSED WASHER**



Part No.*	Description
G714 EG	1 1/8" x 1 1/8" 12 gauge square washer

Holds down grating from above. Eliminates trip points.

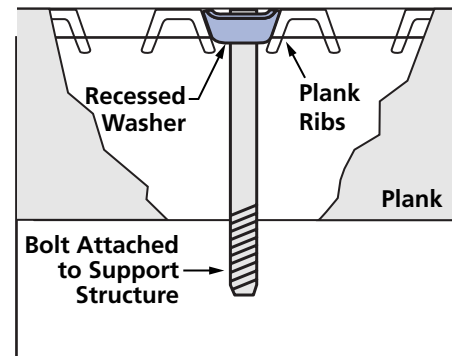

\*Part numbers shown are for galvanized. Most accessories are also available in aluminum.

## Heavy-Duty Stair Treads

Anyone who has slipped on a stairway can appreciate the safety of the anti-skid stair treads. Those who have tried to clean solid-surface stairs can appreciate our maintenance-free slotted design, which is both rust-resistant and self-cleaning. United's stair treads make it easy for you to meet OSHA regulations. Factors to consider when selecting stair treads include loads, impact, frequency of



use, and future use. Our 10½" and 11" tread features a checker-plate nosing that strengthens the tread and increases the width of the basic 9" tread.

The failure loading data shown below indicates ultimate failure in pounds at various spans. A 3½" diameter load was applied to the outer edge of a 9" wide stair tread at the center of the span. 6" wide stair treads are also available.



*The stair treads can also be used with Unistrut Metal Framing as shown here to create a stair with guide rail*

### 9" Stair Tread

14 gauge x 2½" x 9"  
Completely galvanized,  
welded 10 gauge  
end plates



Part No.*	Length (in.)
G 900-24 PG	24
G 900-36 PG	36
G 900-48 PG	48

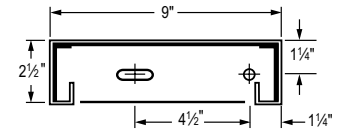

### 10½" Stair Tread

14 gauge x 2½" x 10½",  
Completely galvanized,  
welded 10 gauge end plates



Part No.*	Len. (in.)
G 901-24 PG	24
G 901-36 PG	36
G 901-48 PG	48

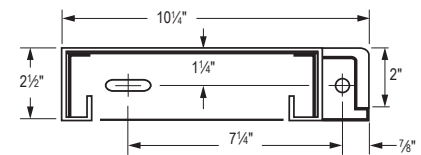

### 11" Stair Treads

14 gauge x 2½" x 11" Completely galvanized, welded  
10-gauge end plates

Part No.*	Len. (in.)
G 904-24 PG	24
G 904-36 PG	36
G 904-48 PG	48

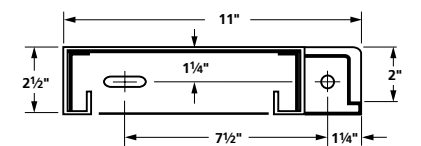

Allowable Loads: Interlock Grating Stair Treads—Galvanized Steel—3 Widths			
Width	Distance Between Supports (feet)		
	2	3	4
9"	880	760	640
10½"	1,730	1,360	1,020
11"	1,730	1,360	1,020

**Note:** Values shown provide a Safety Factor of 2.5

1¼" System

19/16" System

Fiberglass System

Special Metals

PrimeAngle

Metal Grating

Roofwalk

Index



**Design Considerations**

Designers must consider both uniform and concentrated loads. Design considerations are most critical where loads are concentrated on a small area. As the area of the application gets larger, the reactions approach those of uniform loads.

**Point (Concentrated) Loads**

Point loads should be distributed over a minimum of two transverse ribs, regardless of what size or gauge plank grating is utilized.

Good design practice for point loading plank grating employs a “foot” plate at the load point with a minimum dimension of 3" x 3". This plate will assure that the point load has been distributed over the two transverse-rib minimum.

Maximum point load per rib on 12" x 18 ga. steel plank grating is 185 lbs.

As a result, through the use of the required 3" x 3" “foot” plate, a maximum design load for the minimum-dimension foot plate is 370 lbs. Higher loads can be supported by the transverse ribs. However, larger “foot” plates will then be required to distribute the higher loads over additional ribs.

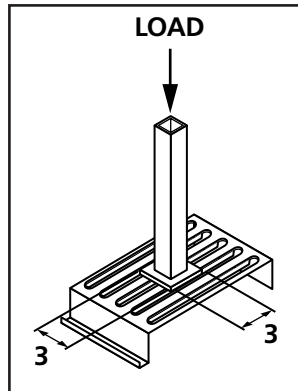

**Testing**

Unistrut is dedicated to the research, development and testing of all our manufactured products. The United Interlock Grating System has been tested in accordance with section 6 of the American Iron and Steel Institute’s (AIS) Specifications for the Design of Cold Formed Steel Structural Members.

Tests for allowable loads were performed on product randomly selected from stock. These tests were run on simple spans with no end restrictions, over a 2" end bearing. Concentrated loads were applied across the plank with a 3" bearing, while uniform loads were applied by stacking narrow strips of sheet steel uniformly over the plank surface. Concentrated load tests for galvanized steel grating were run on all strength combinations for spans of 2', 3', 4', 5', 6', 7', 8', 10', 12', 14', 16' and 18'. Uniform load tests for galvanized steel were run on spans of 2', 3', 4', 6', 8' and 10'.

Concentrated load results are the same for 6" and 9" wide planks.



**Loads and Deflection – 6" Planks**

6" x 14 Gauge	Leg Height	Codes	Distance Between Supports (Feet)															
			2	2.5	3	3.5	4	4.5	5	5.5	6	6.5	7	8	9	10	12	14
			1½"	UL	1,232	788	548	402	293	204	150	113	86	68	54	–	–	–
UD	0.05	0.08		0.12	0.16	0.20	0.22	0.25	0.27	0.30	0.32	0.35	–	–	–	–	–	
CL	616	493		411	352	308	274	234	193	162	138	119	–	–	–	–	–	
CD	0.04	0.06		0.10	0.13	0.17	0.21	0.25	0.27	0.30	0.32	0.35	–	–	–	–	–	
2½"	UL	4,886	3,296	2,150	1,601	1,257	924	734	597	501	431	369	263	204	150	84	47	
	UD	0.15	0.17	0.18	0.22	0.26	0.36	0.41	0.45	0.47	0.52	0.61	0.81	0.89	1.13	1.33	1.42	
	CL	2,443	2,060	1,612	1,400	1,257	1,040	917	820	752	700	647	525	460	374	250	165	
	CD	0.17	0.17	0.17	0.20	0.22	0.25	0.29	0.34	0.40	0.46	0.55	0.66	0.79	0.90	1.07	1.18	
4"	UL	5,261	4,016	3,147	2,321	1,755	1,520	1,307	1,019	858	738	648	548	420	342	215	165	
	UD	0.08	0.10	0.11	0.13	0.16	0.16	0.17	0.23	0.27	0.33	0.40	0.52	0.65	0.82	1.07	1.18	
	CL	2,630	2,510	2,360	2,080	1,755	1,710	1,633	1,400	1,288	1,200	1,134	1,094	980	854	643	577	
	CD	0.13	0.14	0.15	0.17	0.18	0.19	0.20	0.23	0.26	0.30	0.33	0.45	0.57	0.69	0.91	1.26	

6" x 18 Gauge	Leg Height	Codes	Distance Between Supports (Feet)															
			2	2.5	3	3.5	4	4.5	5	5.5	6	6.5	7	8	9	10	12	14
			2½"	UL	2,472	1,664	1,220	881	663	516	414	342	284	237	197	164	134	102
UD	0.14	0.15		0.16	0.21	0.26	0.31	0.36	0.38	0.44	0.47	0.49	0.79	0.89	1.12	1.37	1.58	
CL	1,236	1,040		915	770	663	580	518	470	426	385	344	327	300	255	200	140	
CD	0.12	0.14		0.16	0.18	0.21	0.24	0.28	0.29	0.30	0.37	0.46	0.61	0.74	0.91	1.20	1.50	

6" Aluminum (0.080)	Height	Codes	Distance Between Supports (Feet)															
			2	2.5	3	3.5	4	4.5	5	5.5	6	6.5	7	7.5	8	9	10	
			2½"	UL	2,676	1,590	1,065	840	706	600	517	412	313	277	255	210	177	–
UD	0.20	0.30		0.35	0.40	0.47	0.55	0.63	0.78	1.01	1.09	1.20	1.4	1.66	–	–		
CL	1,338	925		825	755	706	630	575	515	469	435	410	385	355	–	–		
CD	0.16	0.20		0.25	0.31	0.36	0.45	0.54	0.67	0.81	0.90	0.99	1.12	1.27	–	–		

**Code Key:** UL = Uniform Load (pounds per square foot)  
 UD = Deflection under uniform load (Inches)  
 CL = Concentrated Load (pounds)  
 CD = Deflection under concentrated load (Inches)

1¼" System

1½" System

Fiberglass System

Special Metals

PrimeAngle

Metal Grating

Roofwalk

Index



1 1/4" System

1 3/16" System

Fiberglass System

Special Metals

PrimeAngle

Metal Grating

Roofwalk

Index

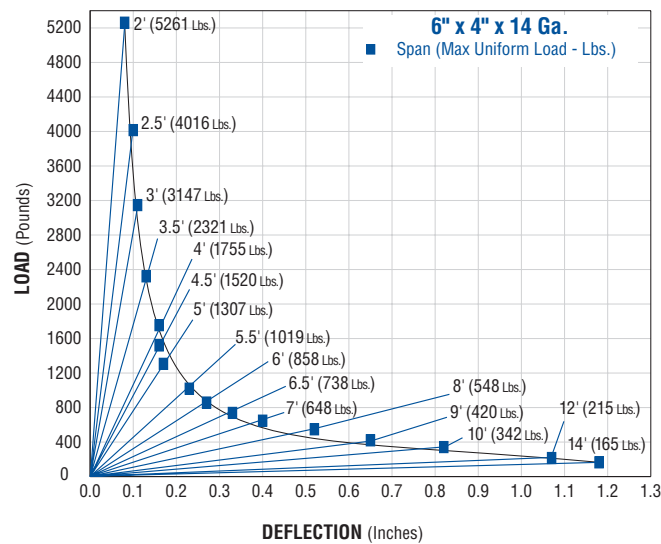
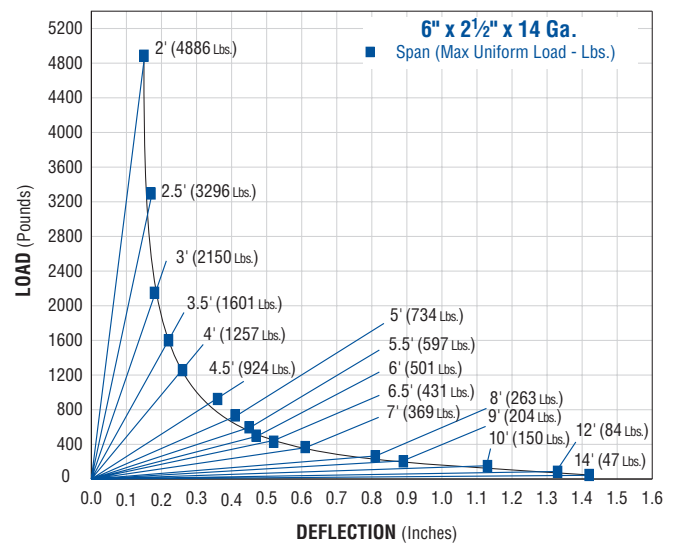
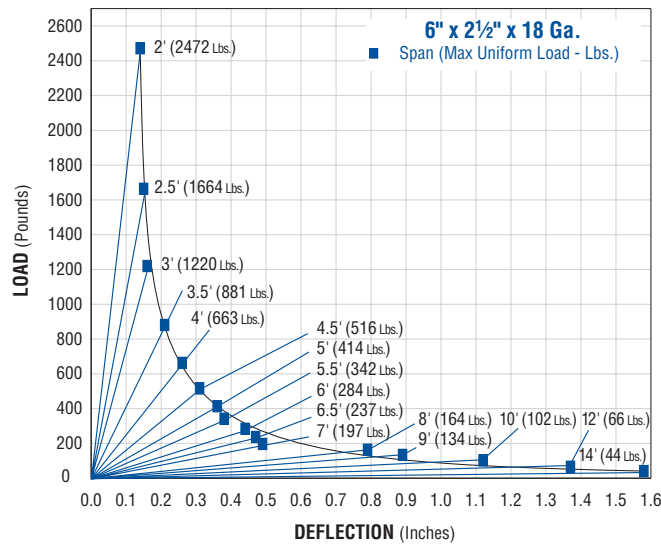
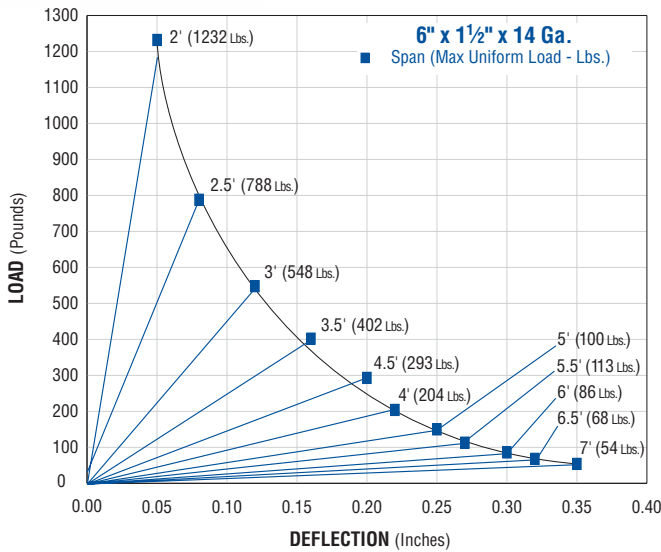

**Loads and Deflection – 9" Planks**

9" x 14 Gauge	Leg Height	Codes	Distance Between Supports (Feet)															
			2	2.5	3	3.5	4	4.5	5	5.5	6	6.5	7	8	9	10	12	14
1½"	UL	UL	821	525	365	268	195	136	100	75	57	45	36	–	–	–	–	–
		UD	0.05	0.08	0.12	0.16	0.2	0.22	0.25	0.27	0.3	0.32	0.35	–	–	–	–	–
		CL	612	488	405	346	286	222	179	145	118	98	82	–	–	–	–	–
		CD	0.04	0.06	0.10	0.13	0.16	0.18	0.20	0.22	0.24	0.26	0.28	–	–	–	–	–
2½"	UL	UL	3257	2197	1433	1067	838	616	489	398	334	287	246	175	136	100	56	31
		UD	0.15	0.17	0.18	0.22	0.26	0.36	0.41	0.45	0.47	0.52	0.61	0.81	0.89	1.13	1.33	1.42
		CL	2439	2055	1606	1393	1249	1031	907	810	740	687	632	509	441	355	228	135
		CD	0.12	0.14	0.14	0.18	0.21	0.29	0.33	0.36	0.38	0.42	0.49	0.65	0.71	0.90	1.06	1.14
4"	UL	UL	3507	2667	2098	1547	1170	1013	871	679	572	492	432	365	280	228	143	110
		UD	0.08	0.1	0.11	0.13	0.16	0.16	0.17	0.23	0.27	0.33	0.4	0.52	0.65	0.82	1.07	1.18
		CL	2625	2494	2353	2022	1745	1699	1621	1387	1273	1184	1117	1076	923	831	615	544
		CD	0.06	0.08	0.09	0.10	0.13	0.13	0.14	0.18	0.22	0.26	0.32	0.42	0.52	0.66	0.86	0.94

9" x 18 Gauge	Leg Height	Codes	Distance Between Supports (Feet)															
			2	2.5	3	3.5	4	4.5	5	5.5	6	6.5	7	8	9	10	12	14
2½"	UL	UL	1,648	1,109	813	587	442	344	276	228	189	158	131	109	89	68	44	27
		UD	0.14	0.15	0.16	0.21	0.26	0.31	0.36	0.38	0.44	0.47	0.49	0.79	0.89	1.12	1.37	1.58
		CL	1,236	1,040	915	770	663	580	518	470	426	385	344	327	300	255	200	140
		CD	0.12	0.14	0.16	0.18	0.21	0.24	0.28	0.29	0.30	0.37	0.46	0.61	0.74	0.91	1.2	1.5

9" Aluminum (0.080)	Leg Height	Codes	Distance Between Supports (Feet)												
			2	2.5	3	3.5	4	4.5	5	5.5	6	6.5	7	7.5	8
2½"	UL	UL	1784	1060	710	560	471	400	345	275	209	185	170	140	118
		UD	0.20	0.30	0.35	0.40	0.47	0.55	0.63	0.78	1.01	1.09	1.20	1.40	1.66
		CL	1337	992	797	732	704	672	643	563	466	446	441	388	348
		CD	0.16	0.24	0.28	0.32	0.38	0.44	0.50	0.62	0.81	0.87	0.96	1.12	1.33

**Code Key:** UL = Uniform Load (pounds per square foot)  
 UD = Deflection under uniform load (Inches)  
 CL = Concentrated Load (pounds)  
 CD = Deflection under concentrated load (Inches)

1¼" System

1½" System

Fiberglass System

Special Metals

PrimeAngle

Metal Grating

Roofwalk

Index



1 1/4" System

1 3/16" System

Fiberglass System

Special Metals

PrimeAngle

Metal Grating

Roofwalk

Index

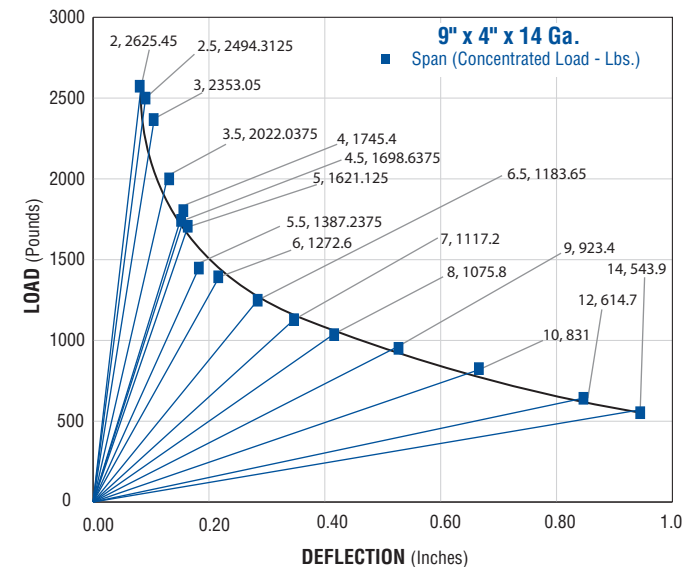
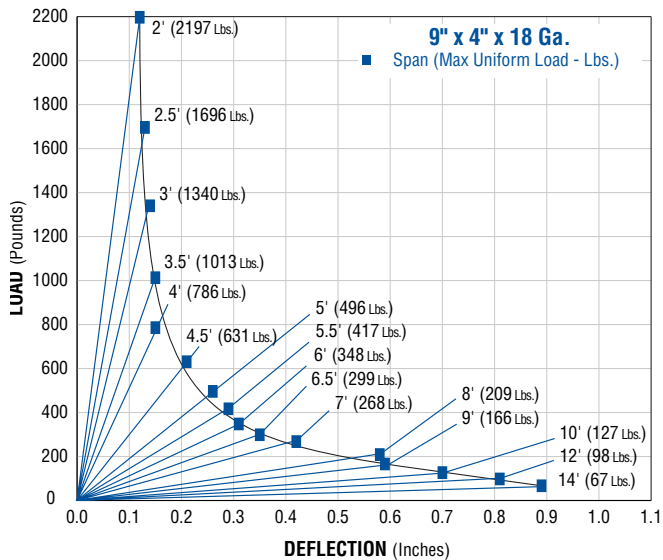
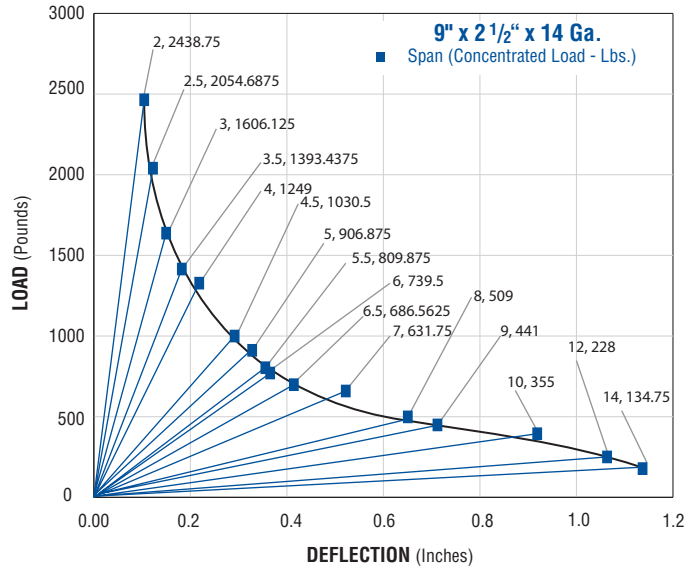
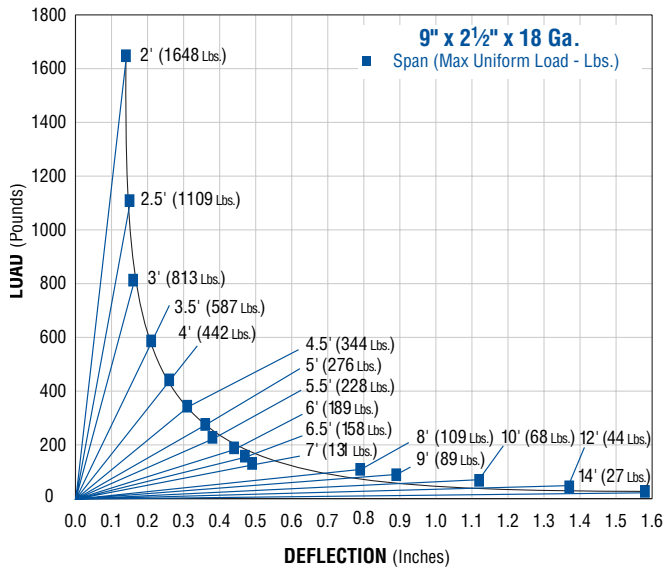
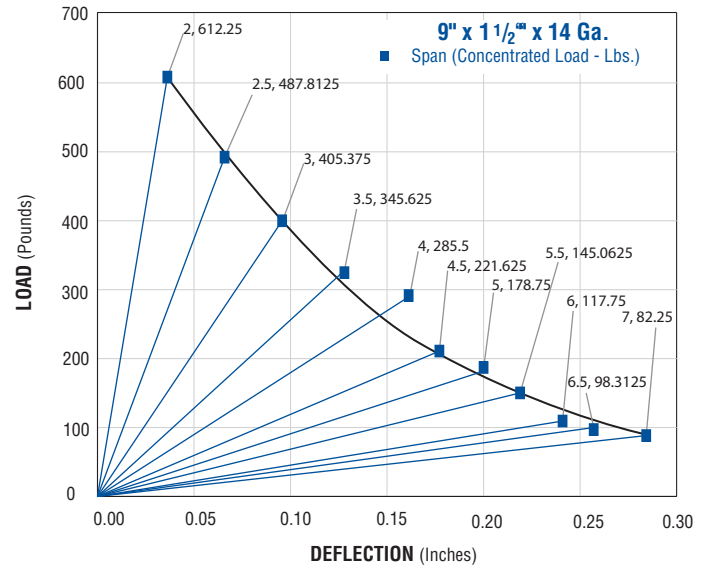
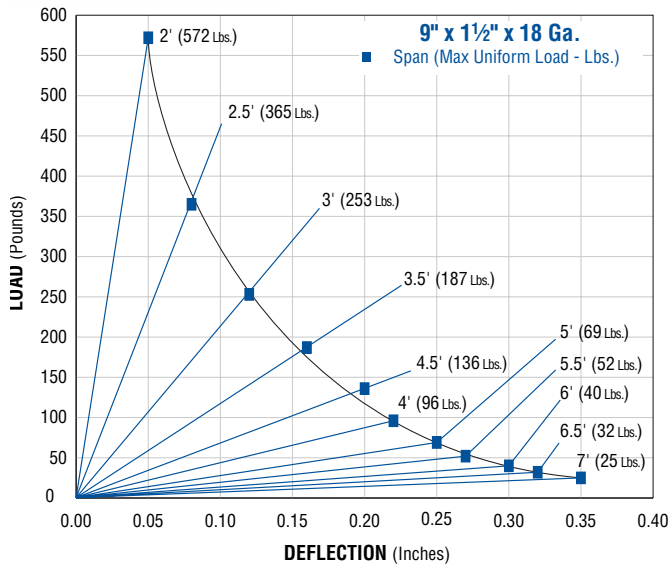

**Concentrated Loads vs. Deflection – 6" & 9" Planks**

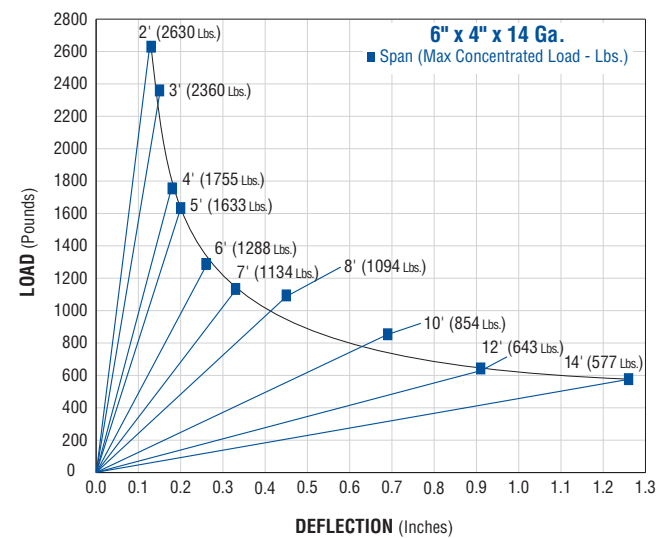
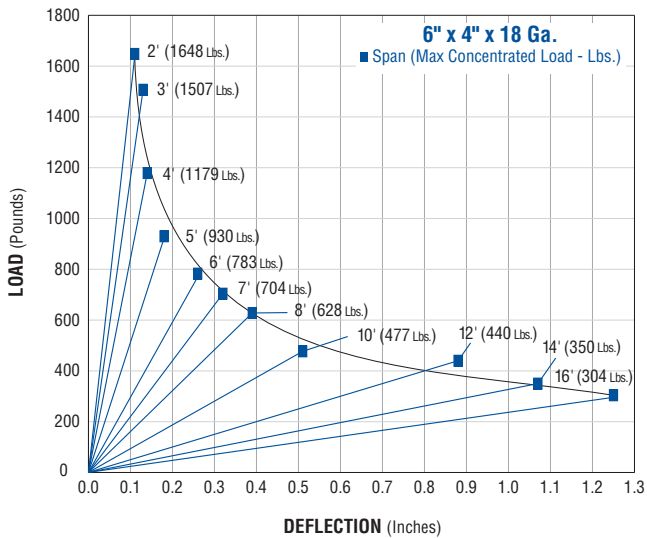
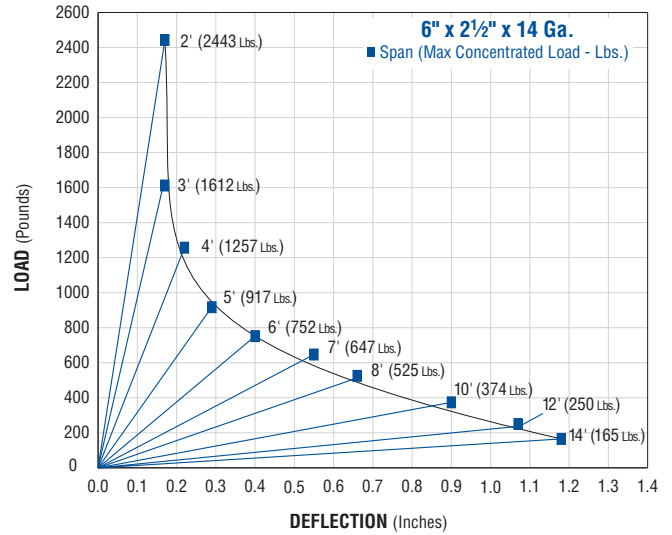
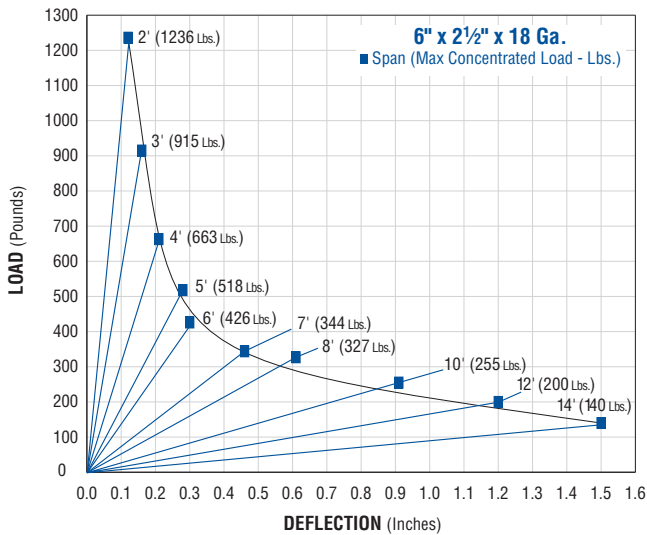
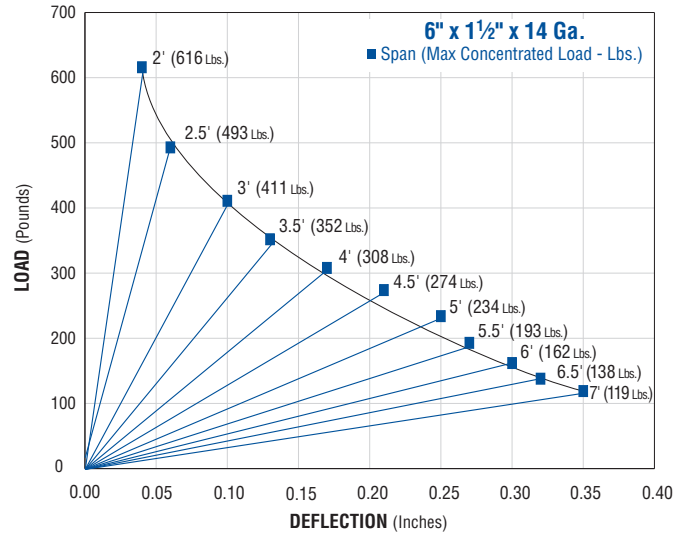
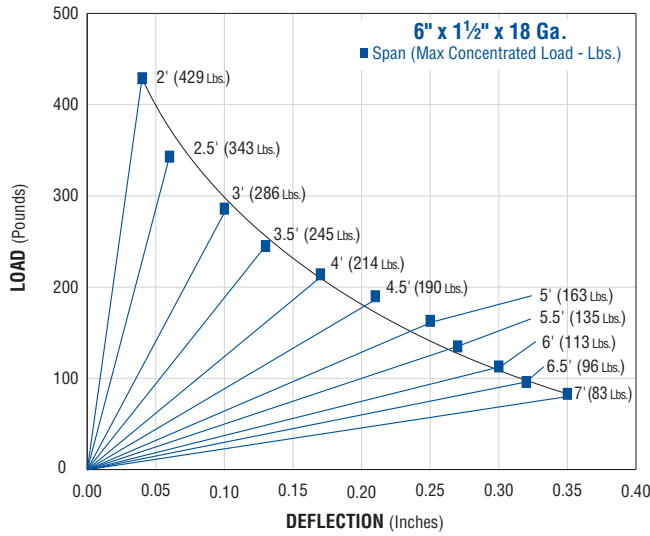

1 1/4" System

1 3/16" System

Fiberglass System

Special Metals

PrimeAngle

Metal Grating

Roofwalk

Index



1 1/4" System

1 3/16" System

Fiberglass System

Special Metals

PrimeAngle

Metal Grating

Roofwalk

Index

12" x 18 Gauge	Leg Height	Codes	Distance Between Supports (Feet)													
			2	2.5	3	3.5	4	4.5	5	5.5	6	6.5	7	7.5	8	
2 1/2"	UL		750	600	500	370	285	225	180	150	127	–	–	–	–	
	UD		0.04	0.07	0.11	0.16	0.20	0.25	0.31	0.37	0.44	–	–	–	–	
	CL		559	559	558	480	421	372	330	301	276	–	–	–	–	
	CD		0.03	0.06	0.09	0.13	0.16	0.20	0.25	0.30	0.35	–	–	–	–	

**Code Key:** UL = Uniform Load (pounds per square foot)  
 UD = Deflection under uniform load (Inches)  
 CL = Concentrated Load (pounds)  
 CD = Deflection under concentrated load (Inches)

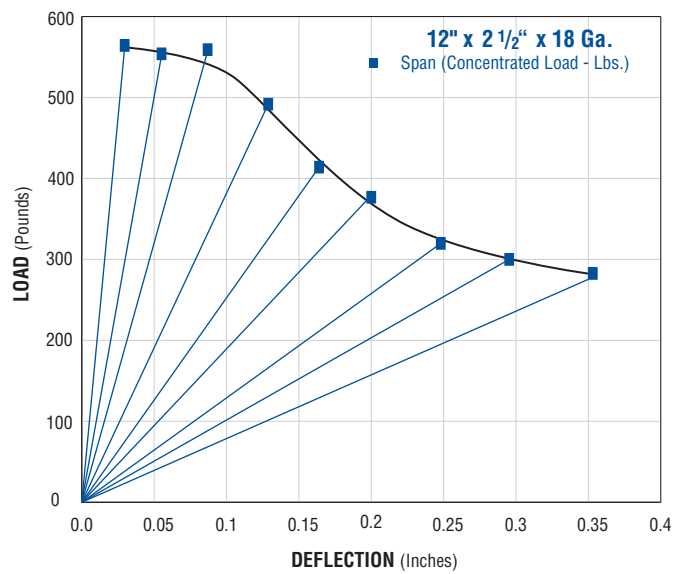
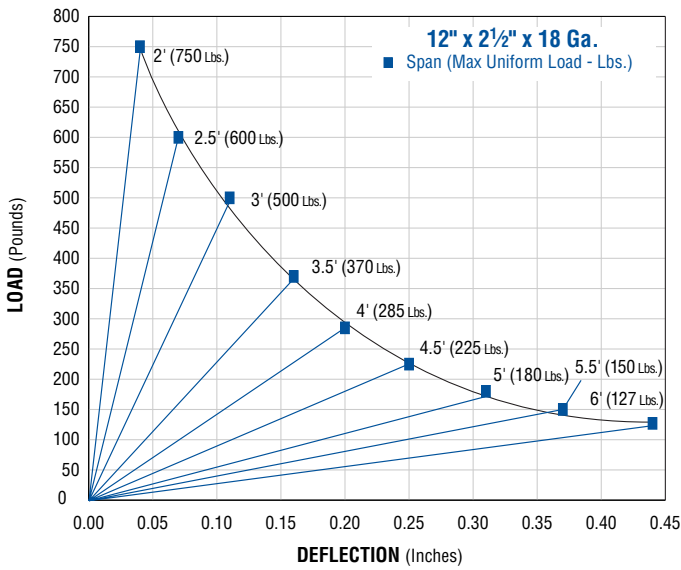

## 1. GENERAL

### 1.1 Scope of Work

- A. Provide all material and labor required for the interlocking plank grating as indicated in the contract documents.

### 1.2 Related Work Specified Elsewhere

- A. Structural Steel  
 B. Cold Formed Metal Framing  
 C. Metal Fabrications

### 1.3 Quality Assurance

- A. Material shall be provided by a qualified contractor with at least five (5) years experience in the manufacture of interlock grating. Contractor shall demonstrate experience in projects of similar scope.
- B. Anti-Skid surfaced grating shall conform to Federal Specification RR-G-1602A.
- C. The Grating shall be designed to withstand the following load criteria:
1. Uniform Live Load \_\_\_\_\_ psf.
  2. Concentrated Load \_\_\_\_\_ lbs.
- D. Contractor shall certify that grating has been tested, indicating maximum allowable uniform and concentrated loads, with a factor of safety of 2, per AISC, Section 6.
- E. If product is required in nuclear and/or safety related application, it shall be supplied under the requirements of nuclear specification 10CFR 50 appendix B.

### 1.4 Submittals

- A. Contractor shall submit shop drawings showing grating layout, support structure and detailed sections depicting assembly.

## 2. PRODUCTS

### 2.1 Acceptable Manufacturer

- A. In order to define the requirements for quality, function, sizes, gauges, surfaces, etc., these material specifications designate manufacturers, brands and other pertinent data that describe the minimum product standards of the products that conform to the project's requirements.
- B. Products of other manufacturers may also be acceptable, provided that such products are equivalent to, or better than, those specified and, further, that use of such substitute products will not involve additional cost to owner due to possible required changes to accommodate them.

- C. The alternate (substitute) product must be a proven equivalent to that specified by submitting technical data, test reports, samples, typical details, comparative layout and engineering calculations for evaluation.
- D. The acceptance of an alternate (substitute) product is at the discretion of the owner or his agents, whose decision shall be final.

### 2.2 Products

- A. Grating shall be United Interlock Plank Grating System, as manufactured by Unistrut, 16100 S. Lathrop Ave., Harvey, IL 60426 (U.S.A.), Phone (800) 468-9510.
- B. Materials shall conform to ASTM A653, Grade A with a Class G-90 coating.
- C. Material shall be \_\_\_\_\_ gauge. With a leg height of \_\_\_\_\_ inches.
- D. The surface pattern shall provide a minimum of 35% but not more than 42% open area. Openings shall be a minimum of 4" long and a maximum of 3/4" width. The surface shall be \_\_\_\_\_.
1. Anti-Skid surface shall provide 360° positive traction and be made of tapered self-cleaning teeth, approximately 1/8" high.
  2. Anti-Skid surface teeth shall have slots approximately 1/16" wide by 3/8" long, uniformly spaced with a minimum of 60 and a maximum of 80 teeth per square foot.

## 3. INSTALLATION

### 3.1 Site Examination

- A. Contractor shall examine the support structure, work area and conditions for the grating installation. If the supports, area or conditions are not satisfactory, installation shall not commence until satisfactory conditions are present.

### 3.2 Erection

- A. Grating shall be installed as detailed on the approved shop drawings.
- B. Grating shall be installed in single, unspliced sections for all requirements to 20' lengths.
- C. Grating shall interlock, with male-female legs providing a lock prohibiting horizontal movement. The outside leg of all members shall be male.
- D. Connections of grating to support elements shall be by bolting, clamping, screwing, welding or use of a manufacturers approved hold-down clip.

Roofwalks® Planks .....	233
Hardware for Membrane, Foam or Coated Roof.....	233
Standing Seam Installation .....	233



## PROTECT ROOFS FROM BIGFOOT WITH ROOFWALKS® ROOFTOP WALKWAYS

Roofwalk walkways are your low-cost solution to damage caused by rooftop foot traffic. On membrane, built-up, foam and coated roofs, they protect against puncture, abrasion and wear. On standing-seam metal roofs, workers of all sizes – even the Bigfoots of the world – can walk safely on the anti-skid surface without causing seam distortion, “dishing” or harmful stress to roof panels. Steel planks are strong yet light-weight, making installation quick and easy. Thanks to special system hardware, no roof penetration is required for anchoring. Roofwalks are versatile and adapt to any roofing system.

## ROOFWALKS® SYSTEMS WILL...

- Provide a safe walkway for rooftop traffic
- Protect the roof from foot traffic
- Resist weather in either galvanized steel or aluminum finish
- Attach to all metal standing-seam roofs (including metric)

## ROOFWALKS® SYSTEMS WILL NOT...

- Penetrate rooftop surface (except on rib roofs)
- Trap water  
...like rubber pads will
- Curl causing trip hazards  
...like rubber pads will
- Disappear in snow  
...like rubber pads will
- Rot or disintegrate  
...like wood or patio blocks will



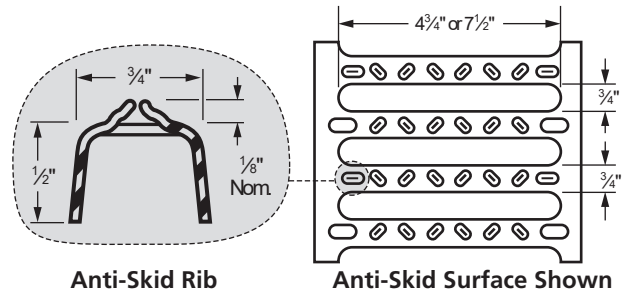
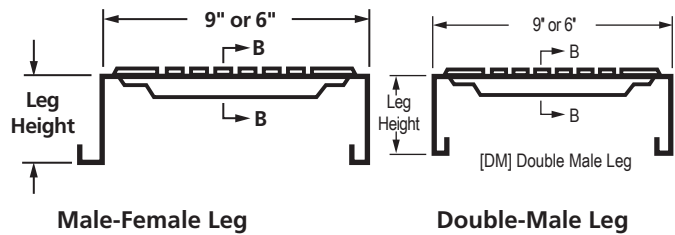

**Interlocking Planks** 20' or 24' planks in 6", 9" or 12" widths roll formed from 18 gauge galvanized steel (G-90 coating). Planks available with double-male or male-female leg shapes. Anti-Skid surface and 2½" leg height, standard.

Roofwalk Grating (20' & 24' Stock Lengths)			
Leg Height: 2½"; Finish: PG; Surface: Anti-Skid			
Part No.	Plank Width	Leg Shape	Weight Lbs./Ft.
G 91282	9"	DM	2.7
G 92282		MF	2.7
G 61281	6"	DM	2.3
G 62281		MF	2.3
G 11282	12"	DM	3.2
G 12282		MF	3.2



**MEMBRANE / COMPOSITE INSTALLATION**

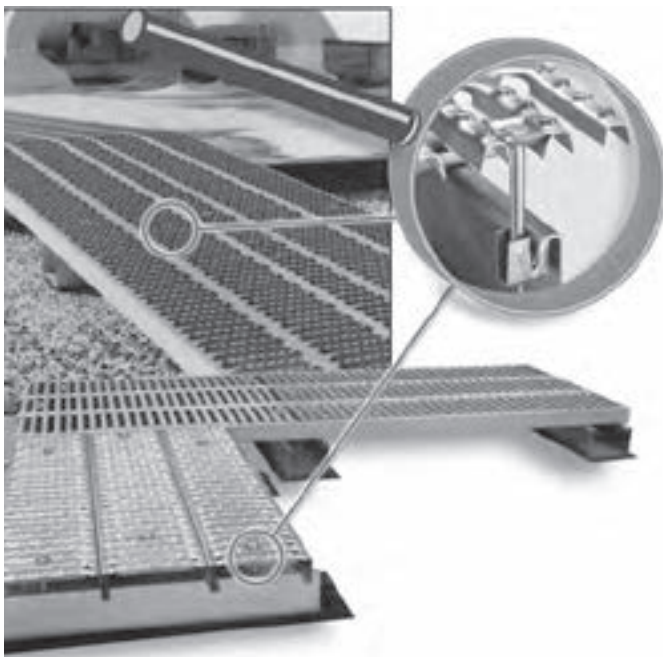

Installation on a membrane roof uses the support stands or the Unipier® sleeper support as a mounting platform.

Refer to our website ([www.unistrut.com](http://www.unistrut.com)) for detailed installation instructions and a description of the mounting hardware used.

**STANDING SEAM INSTALLATION**

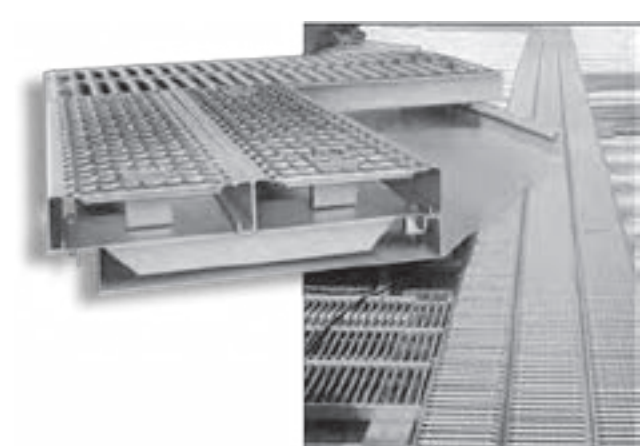

Installation on a standing seam roof uses a custom support plate specifically designed for each manufacturer's standing seam roof to form a mounting platform.

The mounting hardware also depends on the specific standing seam roof. Refer to our website ([www.unistrut.com](http://www.unistrut.com)) for detailed installation instructions and a description of the mounting hardware used.

# PRODUCT INDEX

004M007 thru 034M040.....	114	20P-1100, 20V-1100.....	191	625E-999.....	19
004T008 thru 098N106, 009N012 thru		20P-1200, 20V-1200.....	191	625PU.....	193
106N114.....	113	20P-1300, 20V-1300.....	191	625PU-000 thru F625PU-350.....	194
1.5 Pipe Strap.....	158	20P-2000 SST, 20V-2000 SST.....	190	625PU-125.....	194
1.5 Pipe Support.....	158	20P-2000, 20V-2000.....	190	625PU-FN-000.....	194
1.5 Spacer.....	160	20P-2100 SST, 20V-2100 SST.....	192	750E-999.....	194
100.....	199	20P-2100, 20V-2100.....	190	750PU.....	194
1000E.....	194	20P-2200 SST, 20V-2200 SST.....	192	750PU-FN-000.....	194
10-DS.....	163	20P-2200, 20V-2200.....	190	AIC-EC.....	195
10-H.....	163	20P-2300 SST, 20V-2300 SST.....	192	CVHPU.....	199
10PU.....	193	20P-2300, 20V-2300.....	190	PCR.....	198
12-BS.....	158	20P-2500, 20V-2500.....	196	PS.....	198
12PU.....	193	20P-2502, 20V-2502.....	196	RGBC.....	200
16-BS.....	157	20P-2504, 20V-2504.....	196	UB.....	195
16-BS.....	158	20P-2506, 20V-2506.....	196	A1000.....	171
16-H.....	163	20P-2508, 20V-2508.....	196	A1000 EA.....	208
16-H Base.....	161	20P-2510, 20V-2510.....	196	A1001.....	171
16-H-DB.....	163	20P-2512, 20V-2512.....	196	A1001A.....	172
2.5-CS.....	157	20P-2514, 20V-2514.....	196	A1001B.....	172
2.5-CS-7.....	157	20P-2516, 20V-2516.....	196	A1001C.....	172
2.5-SB-H.....	162	20P-2518, 20V-2518.....	196	A1006.....	175
3-R Spacer.....	160	20P-2520, 20V-2520.....	196	A1007.....	175
3-R-2.....	158	20P-2522, 20V-2522.....	196	A1008.....	175
3-R-2 Pipe Strap.....	158	20P-2524, 20V-2524.....	196	A1026.....	176
3-R-4.....	158	20P-2526, 20V-2526.....	197	A1031.....	176
3-R-4 Pipe Strap.....	158	20P-2528, 20V-2528.....	197	A1036.....	176
3-RAH.....	159	20P-2530, 20V-2530.....	197	A1047.....	177
3-RAH.....	160	20P-2534, 20V-2534.....	197	A1063.....	175
3-RAH Pipe Strap.....	159	20P-2540, 20V-2540.....	197	A1065.....	175
4-RAH-7.....	160	20PU.....	193	A1066.....	176
5-R.....	158	20PU.....	197	A1068.....	176
5-RAH.....	159	24-BS-4.....	157	A1184.....	175
5-SB-H.....	162	200-4101.....	199	A1184P.....	175
6-DS, 6-DSA.....	163	200-4217 thru F200-4343.....	193	A1191.....	175
6-H.....	163	250E.....	194	A1280.....	175
6-H Base.....	161	250PU.....	194	A1325.....	176
6-RAH.....	159	312PU.....	193	A1326.....	176
6-RAH Pipe Strap.....	159	375E.....	194	A1458.....	176
8-DS, 8-DS-DB, 8-DSA.....	163	375PU.....	200	A2084.....	176
8-H.....	163	375PU-000 thru F375PU-300.....	194	A2110.....	176
8-H Base.....	161	375PU-CN.....	193	A2126.....	176
8-H-DB.....	163	375PU-CNHD.....	193	A2223.....	176
8-RAH.....	159	375PU-FN-000.....	194	A2227.....	176
8-RAH Pipe Strap.....	159	500E-999.....	194	A2324.....	176
8-SB-H, 8-SB-HD.....	162 200-3827 thru	500PU.....	193	A2345.....	176
200-3843.....	195	500PU.....	193	A2472.....	176
20-BS.....	157	500PU.....	200	A2492.....	177
20-BS-7.....	157	500PU-000.....	194	A2494.....	177
20E-5000.....	195	500PU-FN-000.....	194	A2608 thru A2617.....	177
20N.....	200	50PU.....	197	A3006.....	175
20P-1000, 20V-1000.....	191	50PU-500SP.....	194	A3007.....	175

## Part Number Index

A3008.....	175	G92141 thru G92143.....	219	P1001 EA.....	208
A3016.....	175	G92181 thru G92183.....	219	P1001 SS.....	206
A3300.....	173	G92221 thru G92223.....	219	P1001 T.....	27
A3301.....	173	G92241 thru G92243.....	219	P1003.....	27
A3347.....	177	G92281 thru G92283.....	219	P1004 A.....	27
A4000 EA.....	208	G92341 thru G92343.....	219	P1006-0832.....	73
A4001 EA.....	209	G92381 thru G92383.....	219	P1006-1024.....	73
A4006.....	175	HCSS.....	74	P1006-1420.....	73
A4007.....	175	HFLW.....	75	P1006T1420.....	73
A4008.....	175	HFMS.....	74	P1007.....	73
A4280.....	175	HHCS.....	74	P1008.....	73
A5007.....	175	HHXN.....	75	P1008T.....	73
A5008.....	175	HLKW.....	75	P1009.....	73
CG-10 thru CG-40.....	116	HOCW.....	76	P1010.....	73
CL04 thru CL18.....	114	HRCN.....	75	P1010T.....	73
CN04 thru CN34.....	115	HRMS.....	74	P1012.....	73
Deck Plates 12 SS.....	160	HSHS.....	74	P1012S.....	73
Deck Plates 18 SS.....	160	HSQN.....	75	P1016.....	73
G 11282.....	233	HSQN050.....	144	P1023.....	73
G 12282.....	233	HTHR.....	75	P1023S.....	73
G 61281.....	233	HT04 thru HT34.....	115	P1024.....	73
G 62281.....	233	J1205 thru J1280.....	117	P1024S.....	73
G 91282.....	233	K1062.....	76	P1026.....	82
G 92282.....	233	K1063.....	76	P1028.....	82
G11281.....	219	K1064.....	76	P1029.....	84
G12281.....	219	LS 410.....	106	P1031.....	82
G124.....	222	LS 500.....	106	P1033.....	83
G31183 thru G31383.....	220	M2037.....	133	P1034.....	83
G600 thru G639.....	221	M2050.....	133	P1035.....	84
G603 thru G642.....	220	M2137.....	133	P1036.....	81
G61141 thru G61143.....	219	M2150.....	133	P1037.....	83
G61181 thru G61183.....	219	M2250.....	133	P1038.....	83
G61221 thru G61223.....	219	M2350.....	133	P1043A.....	88
G61241 thru G61243.....	219	M24.....	144	P1044.....	88
G61281 thru G61283.....	219	M2506.....	144	P1045.....	86
G61341 thru G61343.....	219	M2508.....	144	P1046A.....	88
G61381 thru G61383.....	219	M2510.....	144	P1047.....	87
G62141 thru G62143.....	219	M2512.....	144	P1048, P1049, P1050.....	88
G62181 thru G62183.....	219	M2523.....	144	P1062.....	81
G62221 thru G62223.....	219	M2524.....	144	P1063.....	81
G62241 thru G62243.....	219	MU025 thru MU400.....	111	P1064.....	81
G62281 thru G62283.....	219	P1000.....	24	P1065.....	81
G62341 thru G62343.....	219	P1000 DS.....	24	P1066.....	81
G640.....	222	P1000 EA.....	208	P1067.....	81
G714.....	222	P1000 H3, P1000 HS, P1000 KO, P1000 SL.....	24	P1068.....	82
G900 thru G904.....	223	P1000 SS.....	206	P1075.....	91
G91141 thru G91143.....	219	P1000 T, P1000 WT.....	24	P1100.....	30
G91181 thru G91183.....	219	P1000HS SS.....	206	P1100 HS, P1100 KO, P1100 SL.....	30
G91221 thru G91223.....	219	P1000T SS.....	206	P1100 SS.....	206
G91241 thru G91243.....	219	P1001.....	24	P1100 T.....	30
G91281 thru G91283.....	219	P1001 3.....	27	P1100 WT.....	30
G91341 thru G91343.....	219	P1001 A, P1001 A3, P1001 B, P1001 B3.....	27	P1100HS SS.....	206
G91381 thru G91383.....	219	P1001 C, P1001 C3, P1001 C41, P1001 D3.....	27	P1100T SS.....	206

1/4" System

3/16" System

Fiberglass System

Special Metals

PrimeAngle

Metal Grating

Roofwalk

Index



1 1/4" System	P1101.....	30	P1454.....	86	P1956.....	84
	P1101 A, P1101 B, P1101 C.....	30	P1455.....	87	P1957.....	84
	P1101 SS.....	206	P1458.....	82	P1959.....	81
	P1109 thru P1126.....	108	P1479A thru P1479E.....	86	P1960.....	81
	P1130.....	85	P1498.....	83	P1961.....	81
	P1131.....	85	P1499.....	83	P1962.....	82
	P1180.....	61	P1538A thru P1538D.....	83	P1964.....	81
	P1180W.....	132	P1546, P2094 thru P2100.....	85	P1973.....	88
	P1184 P.....	60	P1563 thru P1573.....	109	P1985S.....	100
	P1186, P2105 thru P2110.....	85	P1579.....	84	P1986S.....	100
1 3/16" System	P1201.....	103	P1593.....	91	P2000.....	33
	P1202.....	103	P1640.....	97	P2000 HS, P2000 KO, P2000 SL, P2000 T, P2000 WT.....	33
	P1203.....	103	P1648S thru P1653S.....	97	P2001.....	33
	P1204 thru P1208.....	103	P1654A thru P1661A.....	97	P2001 A.....	33
	P1211 thru P1217.....	109	P1690 thru P1697.....	129	P2001 B.....	33
	P1271S.....	98	P16F.....	134	P2001 C.....	33
	P1272S.....	100	P1703.....	145	P2008 thru P2020.....	109
	P1280.....	61	P1704.....	145	P2024 thru P2070-84.....	110
	P1280 EA.....	209	P1713.....	84	P2070.....	110
	P1280A.....	61	P1723.....	82	P2072 SQ.....	90
Fiberglass System	P1280W.....	132	P1726.....	82	P2072.....	90
	P1281.....	82	P1727.....	84	P2072A SQ.....	90
	P1282.....	82	P1728.....	84	P2072A.....	90
	P1283.....	82	P1730.....	86	P2073 SQ.....	90
	P1290.....	84	P1732.....	88	P2073.....	90
	P1291.....	84	P1734.....	86	P2073A SQ.....	90
	P1315.....	82	P1736.....	86	P2073A.....	90
	P1320.....	87	P1737.....	88	P2079.....	81
	P1325.....	83	P1747.....	83	P2101 thru P2104.....	85
	P1326.....	83	P1750.....	83	P21H.....	134
Special Metals	P1334.....	81	P1753, P1754.....	128	P2223.....	89
	P1346.....	83	P1769.....	90	P2224.....	89
	P1347.....	86	P1771.....	90	P2225.....	89
	P1354.....	104	P1773.....	91	P2226.....	89
	P1354A.....	104	P1775.....	91	P2227.....	89
	P1356.....	82	P1777.....	91	P2228.....	89
	P1357.....	84	P1787 thru P1795.....	130	P2229.....	89
	P1358.....	82	P1796S.....	98	P2230.....	89
	P1359.....	84	P1821.....	83	P2231, P2232.....	93
	P1363A thru P1363E.....	87	P1822.....	83	P2231A, P2232A.....	93
PrimeAngle	P1376.....	87	P1823.....	83	P2233, P2234.....	93
	P1376A.....	87	P1834.....	102	P2233A, P2234A.....	93
	P1377.....	87	P1834A.....	102	P2235.....	84
	P1379S.....	100	P1843.....	104	P2237.....	88
	P1380.....	81	P1873.....	82	P2243.....	119
	P1380 A.....	81	P1887.....	90	P2245.....	89
	P1381.....	84	P1924.....	81	P2260 thru P2270.....	85
	P1382.....	84	P1925.....	81	P2280.....	61
	P1383.....	88	P1934.....	84	P2280A.....	61
	P1386.....	100	P1941.....	81	P2280W.....	132
Metal Grating	P1425 thru P1431.....	109	P1944.....	103	P2324.....	81
	P1430.....	110	P1950.....	82	P2325.....	81
	P1453.....	86	P1953.....	82		

P2326.....	88	P2535.....	130	P2859.....	61
P2328.....	88	P2536.....	130	P2860.....	61
P2329.....	88	P2537.....	131	P2862.....	81
P2341 R-L.....	89	P2539.....	131	P2863.....	81
P2343 R-L.....	89	P2540.....	132	P2864.....	81
P2344 R-L.....	89	P2540A.....	132	P2865.....	144
P2345.....	89	P2541.....	132	P2867.....	98
P2346.....	89	P2542 thru P2546.....	92	P2867A, P2867B.....	98
P2347.....	89	P2547 thru P2551.....	91	P2868.....	99
P2348.....	90	P2552.....	133	P2868A, P2868B.....	99
P2354 R-L.....	103	P2558.....	110	P2893.....	99
P2355 R-L.....	103	P2558.....	110	P2894.....	99
P2360.....	86	P2600.....	112	P2895.....	99
P2378.....	74	P2602.....	131	P2896.....	99
P2379.....	74	P2626.....	82	P2897.....	95
P2380.....	74	P2645A thru P2645H.....	129	P2898.....	96
P2381.....	74	P2645H.....	129	P2899.....	96
P2382.....	74	P2647A thru P2647F.....	129	P2900.....	133
P2398S.....	97	P2649A thru P2649H.....	128	P2901.....	133
P2401S.....	97	P2655.....	103	P2902.....	133
P2403S.....	97	P2674.....	97	P2903.....	133
P2405S.....	97	P2675.....	95	P2904.....	133
P2407.....	61	P2676.....	96	P2920.....	136
P2407.....	145	P2677.....	96	P2921.....	136
P2452.....	94	P2679-4, -6 & -8.....	96	P2922.....	136
P2453.....	90	P2682.....	96	P2923.....	136
P2454.....	103	P2749.....	102	P2924.....	136
P2458-18 thru P2458-36.....	94	P2749N.....	102	P2928.....	136
P2459-36 thru P2459-96.....	94	P2750.....	102	P2929.....	136
P2469.....	86	P2750N.....	102	P2930.....	136
P2471.....	81	P2751.....	102	P2932.....	136
P2472 R-L.....	89	P2751N.....	102	P2940.....	136
P2473.....	88	P2755.....	131	P2941, P2942.....	90
P2474-1 thru P2474-4.....	118	P2756.....	131	P2944, P2945, P2946, P2947.....	92
P2475.....	118	P2757.....	131	P2949.....	102
P2476.....	119	P2784.....	95	P2950.....	102
P2481.....	119	P2785.....	98	P3000.....	36
P2482.....	119	P2786.....	98	P3000 SS.....	206
P2484.....	85	P2787.....	98	P3000 HS, P3000 KO, P3000 SL, P3000 T,	
P2484W.....	85	P2800.....	87	P3000 WT.....	36
P2485.....	76	P2801.....	132	P3000HS SS.....	206
P2485K.....	76	P2802.....	132	P3000T SS.....	206
P2486.....	76	P2803.....	132	P3001.....	36
P2490.....	81	P2815.....	94	P3006.....	73
P2491 R-L thru P2493 R-L.....	91	P2815D.....	94	P3007.....	73
P2494 R-L thru P2499 R-L.....	92	P2820.....	136	P3008.....	73
P2500 R-L thru P2503 R-L.....	92	P2821.....	136	P3009.....	73
P2513 thru P2516.....	93	P2822.....	136	P3010.....	73
P2513A thru P2516A.....	93	P2823.....	136	P3013.....	73
P2521.....	131	P2824-6,-9,-12.....	98	P3016.....	73
P2521.....	132	P2855.....	131	P3045.....	86
P2522.....	130	P2856.....	131	P3047.....	87
P2534-50, P2534-75.....	129	P2857.....	131	P3087.....	100

1 1/4" System

1 3/16" System

Fiberglass System

Special Metals

PrimeAngle

Metal Grating

Roofwalk

Index



1 1/4" System	P3088.....	100	P3356.....	143	P4100 SL.....	45	
	P3116.....	133	P3357.....	143	P4100 T, P4100 WT.....	45	
	P3165.....	144	P3357A.....	143	P4101.....	45	
	P3170.....	144	P3358.....	143	P4101 T.....	45	
	P3184.....	60	P3359.....	143	P4280.....	61	
	P3184 EA.....	209	P3360.....	143	P4280 EA.....	209	
	P3184 F.....	60	P3361.....	143	P4280W.....	132	
	P3184 P.....	60	P3362.....	143	P4376.....	87	
	P3245.....	144	P3363.....	143	P4376A.....	87	
	P3246.....	141	P3364.....	143	P4377.....	87	
1 3/16" System	P3249.....	142	P3365.....	143	P4400.....	48	
	P3250.....	142	P3366.....	143	P4400 HS.....	48	
	P3251.....	142	P3367.....	143	P4400 SL.....	48	
	P3252.....	142	P3368.....	143	P4400 T, P4400 WT.....	48	
	P3253.....	142	P3369.....	143	P4401.....	48	
	P3254.....	142	P3370.....	143	P4520, P4520 HS, P4520 SL, P4520 T, P4520 WT.....	51	
	P3255.....	142	P3380.....	61	P4521.....	51	
	P3256.....	142	P3380.....	145	P4663.....	145	
	P3257.....	142	P3409 thru P3417.....	111	P4703.....	145	
	P3257A.....	142	P3521.....	131	P4908.....	73	
Fiberglass System	P3258.....	142	P3539.....	131	P5000.....	54	
	P3259.....	142	P3663.....	145	P5000 HS, P5000 KO, P5000 SL, P5000 T, P5000 WT.....	54	
	P3260.....	142	P3700.....	145	P5001.....	54	
	P3261.....	142	P3703.....	145	P5021.....	132	
	P3262.....	142	P3704.....	145	P5077.....	87	
	P3263.....	142	P3712 P.....	60	P5280.....	61	
	P3264.....	142	P3754.....	141	P5280W.....	132	
	P3265.....	142	P3922 thru P3926.....	131	P5500.....	57	
	P3266.....	142	P4000.....	42	P5500 EA.....	208	
	P3267.....	142	P4000 SS.....	206	P5500 HS, P5500 KO, P5500 SL, P5500 T, P5500 WT.....	57	
Special Metals	P3268.....	142	P4000 EA.....	211	P5501.....	57	
	P3269.....	142	P4000 HS.....	42	P5506.....	73	
	P3270.....	142	P4000 SL.....	42	P5506-1420.....	73	
	P3270.....	142	P4000 T, P4000 WT.....	42	P5507.....	73	
	P3280.....	61	P4000HS SS.....	206	P5508.....	73	
	P3280.....	145	P4000T SS.....	206	P5509.....	73	
	P3280W.....	132	P4001.....	42	P5510.....	73	
	P3300.....	39	P4001 EA.....	208	P5521.....	131	
	P3300 HS.....	39	P4003.....	42	P5521 thru P5580.....	132	
	P3300 SL.....	39	P4004.....	42	P5537.....	131	
PrimeAngle	P3300 SS.....	206	P4006.....	73	P5539.....	131	
	P3300 T, P3300 WT.....	39	P4007.....	73	P5543.....	88	
	P3300HS SS.....	206	P4008.....	73	P5545.....	86	
	P3300T SS.....	206	P4009.....	73	P5547.....	87	
	P3301.....	39	P4010.....	73	P5560.....	86	
	P3301 SS.....	206	P4010T.....	73	P5577.....	87	
	P3345.....	86	P4012.....	73	P5580.....	61	
	P3349.....	143	P4023.....	73	P5580 EA.....	209	
	P3350.....	143	P4043.....	88	P5580W.....	132	
	P3351.....	143	P4045.....	86	P6000.....	180	
Metal Grating	P3352.....	143	P4047.....	87			
	P3353.....	143	P4100.....	45			
	P3354.....	143	P4100 HS.....	45			
	P3355.....	143					
	Roofwalk						
Index							

P6000 EA.....	209	P6887.....	185	WEEB - WMC.....	149
P6000 SS.....	206	P6924.....	184		
P6001.....	180	P6925.....	184		
P6001 EA.....	209	P6962.....	184		
P6001A, P6001B, P6001C.....	181	P6973.....	187		
P6006.....	184	P7000.....	182		
P6013.....	184	P7000 EA.....	209		
P6026.....	185	P7000 SS.....	206		
P6028.....	185	P7001.....	182		
P6031.....	185	P7001 EA.....	209		
P6036.....	185	P7006.....	184		
P6045.....	186	P7008 thru P7020.....	187		
P6047.....	186	P7045.....	186		
P6048.....	186	P7047.....	186		
P6062.....	184	P7108 thru P7110.....	186		
P6065.....	184	P7235.....	185		
P6066.....	184	P7280.....	184		
P6067.....	184	P7324.....	184		
P6068.....	185	P7325.....	184		
P6069.....	185	P7376.....	187		
P612.....	.86	P7376A.....	187		
P6127 thru P6129.....	187	P7377.....	187		
P6184 P.....	184	P8000.....	.95		
P6186.....	186	P8001.....	.95		
P6280.....	184	P9000.....	.65		
P6281 thru P6283.....	185	P9010.....	.68		
P6325.....	185	P9011.....	.68		
P6326.....	185	P9012.....	.68		
P6331.....	186	P9013.....	.69		
P6332.....	187	P9014.....	.69		
P6334.....	185	P9200.....	.65		
P6346.....	185	P9207.....	.68		
P6347.....	187	P9209.....	.68		
P6353.....	187	P9324.....	.68		
P6356A, P6358A.....	184	P976.....	.87		
P6357.....	185	PA 158.....	215		
P6359.....	185	PA 1SNB.....	212		
P6376.....	186	PA 238.....	215		
P6376A.....	186	PA 318.....	215		
P6377.....	186	PFL050T.....	101		
P6379 S.....	187	PLF9037 thru PLF9100.....	101		
P6380.....	185	PUX1234 thru PUX41810.....	116		
P6380A.....	185	RSS4.....	153		
P6386.....	187	SLR100.....	149		
P6453.....	186	SLR200.....	149		
P6454.....	186	SPF® 100.....	104		
P6455.....	187	SPF® 200.....	104		
P6458.....	185	SPF® 300.....	105		
P6546.....	186	SPF® 400.....	105		
P6579.....	185	UB1/2PA thru UB12PA.....	115		
P6726A.....	184	UP-BK.....	155		
P6737.....	186	UP-MPDS.....	155		
P6805 thru P6810.....	187	UP-SPSS.....	155		

1 1/4" System

1 3/16" System

Fiberglass System

Special Metals

PrimeAngle

Metal Grating

Roofwalk

Index









## LIMITED WARRANTY

Unistrut® warrants for a period of one year from the date of shipment or completion of installed work, as applicable, that the products or services will be free from defects in workmanship and materials at the time of delivery to the carrier. No warranty is given for products or components that have been (i) manufactured by companies other than Unistrut; (ii) subject to misuse, improper installation, corrosion, or negligence; (iii) disassembled, modified or repaired by unauthorized persons; (iv) used in any manner contrary to Unistrut's instructions or recommendations; or (v) subject to (1) corrosion beyond normal weathering; (2) corrosion caused by disruption of any product coating after production; (3) corrosion occurring at points in the product that have been drilled, cut or welded; or (4) corrosion occurring in unusual or highly corrosive soil, environmental or industrial conditions (in case of corrosion under this subsection (v)(4), Unistrut's limited obligation is to ensure that the product complies with its published specifications).

UNISTRUT DISCLAIMS ALL OTHER WARRANTIES, WHETHER EXPRESS OR IMPLIED, INCLUDING, WITHOUT LIMITATION, ANY WARRANTY OF MERCHANTABILITY OR FITNESS FOR A PARTICULAR PURPOSE, ANY WARRANTY THAT THE PRODUCTS WILL CONFORM TO ANY SAMPLES, ANY WARRANTY THAT THE PRODUCTS WILL NOT DISCOLOR OR THE TEXTURE OR FINISH WILL NOT CORRODE OR DETERIORATE, AND ANY WARRANTY REGARDING ANY ANCILLARY SERVICES RENDERED.

## REMEDY AND LIMITATION OR LIABILITY

If the products do not comply with the warranties set forth in these Terms, Buyer must provide prompt written notice to Unistrut of the non-conformance in reasonably sufficient detail (and such other detail as Unistrut requests) and must comply with Unistrut's instructions and policies regarding the nonconforming product. Buyer must provide such notice within the warranty period. Unistrut's liability will terminate upon expiration of the warranty period. Unistrut's sole liability for non-conforming products will be to repair or replace the non-conforming product or return the purchase price paid therefore, at Unistrut's sole option. Buyer will bear all disassembly, shipment and reinstallation costs of repaired or replaced products. IN NO EVENT WILL UNISTRUT BE LIABLE IN CONTRACT, TORT, STRICT LIABILITY OR OTHERWISE FOR INCIDENTAL, INDIRECT, SPECIAL OR CONSEQUENTIAL DAMAGES, REGARDLESS OF WHETHER UNISTRUT WAS INFORMED OF THE POSSIBILITY OF SUCH DAMAGES, AND IN NO EVENT WILL UNISTRUT'S LIABILITY EXCEED AN AMOUNT EQUAL TO THE SALES PRICE OF THE PRODUCTS.

# UNISTRUT® DEFENDER™

NEW

## CORROSION-RESISTANT PRODUCT LINE

UNISTRUT DEFENDER

VS.

HOT-DIP GALVANIZED



1,000 HOURS CONTINUOUS SALT SPRAY TEST RESULTS

*Unistrut Defender has 3X the performance of traditional Hot-Dip Galvanized products\**

**A breakthrough in corrosion resistance for the metal framing industry.** Unistrut is proud to introduce a new, corrosion-resistant patent pending product line called Unistrut Defender. Scan the QR code below to watch a quick video showing Unistrut Defender's revolutionary self-healing properties, salt spray test, and more. For more information contact your local sales rep or visit [unistrut.us](http://unistrut.us).



View video



[unistrut.us](http://unistrut.us)



**Atkore**  
Unistrut

\* Based on average ASTM B117 salt spray test results from an independent, accredited test laboratory.



Allied Tube & Conduit ▲ AFC Cable Systems ▲ Heritage Plastics ▲ Unistrut  
Unistrut Construction ▲ Cope ▲ US Tray ▲ Calbrite ▲ Calbond ▲ Kaf-Tech  
Columbia-MBF ▲ Eastern Wire + Conduit ▲ ACS/Uni-Fab ▲ Cii  
Power-Strut ▲ Calconduit ▲ Razor Ribbon ▲ Calpipe Security  
Vergokan ▲ Flexicon ▲ Marco

## **Atkore**

16100 South Lathrop Avenue  
Harvey, IL 60426

**TOLL FREE / 800-882-5543**  
**FAX / 708-339-7814**

[atkore.com/unistrut](http://atkore.com/unistrut)

Want to join a company that helps you build  
the mindset, skill set and tool set for success?  
Visit us at [atkore.com/careers](http://atkore.com/careers)