

INSTALLATION INSTRUCTIONS

BREAD DRAWER COVER

TOOLS REQUIRED:

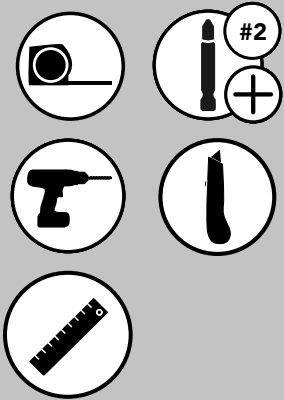

ESTIMATED ASSEMBLY TIME:

15 MIN

CARE AND MAINTENANCE:

Clean with a damp cloth and wipe parts dry.

WATCH TUTORIALS OF OUR PRODUCTS BEING INSTALLED



WWW.REV-A-SHELF.COM/VIDEOS



PARTS LIST

No.	Description	Qty.
A	Bread Drawer Cover	1
B	Rails	2
C	#6 x 1/2" Zinc Pan Head Phillips Screws	6

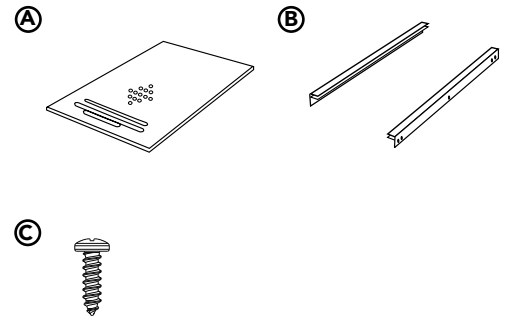

STEP 1

Remove your drawer from the cabinet and mount rails to the outside of the drawer box with provided screws (See Figure A).

STEP 2

If the cover needs trimming, determine the needed width by measuring the distance outside of the rails and subtracting 1/4" (See Figure B).

STEP 3

Transfer the measurements to the cover. To keep the cover centered in the drawer, divide the measurement that needs to be trimmed off by two and cut both the left and right side of the cover (See Figure C).

STEP 4

Cut the cover by scoring the tray several times with a utility knife and straight edge and break off the unneeded pieces.

STEP 5

Slide cover into the rails and reinstall the drawer. Installation is now complete. (See Figure D).

FIG. A

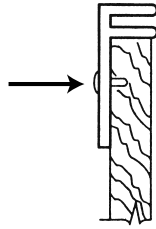

FIG. B

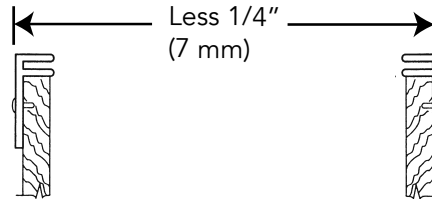

FIG. C

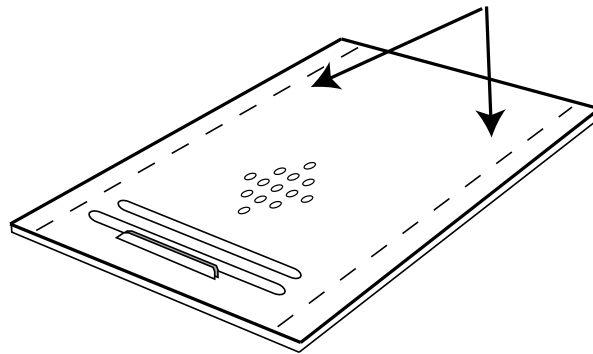
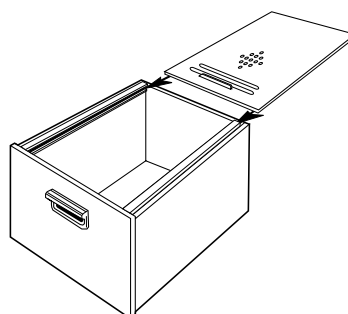

FIG. D



INSTRUCCIONES DE INSTALACIÓN / INSTRUCTIONS D'INSTALLATION

CUBIERTA DEL CAJÓN DEL PAN/ COUVERCLE DU TIROIR À PAIN

Herramientas requeridas:
Outils Requis:

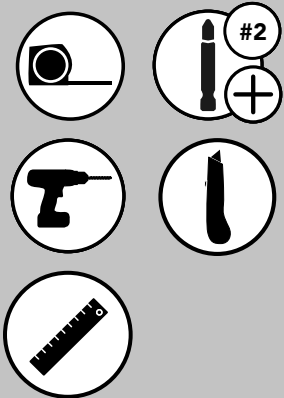

Tiempo estimado de ensamblado
Durée de l'installation:

15 MIN

CUIDADO/ ENTRETIEN:

Limpie con un paño húmedo y seque las partes.

Nettoyez avec un linge humide et essuyez les pièces pour les secher complètement.

VER VIDEOS DE INSTALACIONES DE PRODUCTOS

REGARDER DES VIDÉOS
D'INSTALLATIONS DE PRODUITS



WWW.REV-A-SHELF.COM/VIDEOS



LISTA DE PARTES / LISTE DES PIÈCES

No.	Descripción / Description	Qty.
A	Cubierta de cajón para pan / Couvercle de tiroir à pain	1
B	Rieles / Rails	2
C	6 Tornillos Phillips de cabeza plana de zinc x 1/2" Vis Phillips à tête cylindrique en zinc #6 x 1/2 po	6

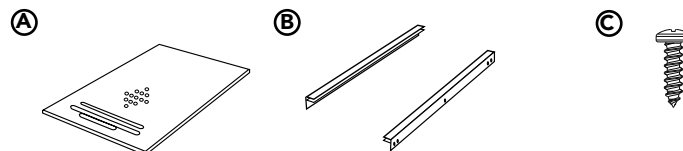

STEP 1

Retire el cajón del gabinete y monte los rieles en el exterior de la caja del cajón con los tornillos provistos (consulte la Figura A).

Retirez votre tiroir du meuble et fixez les rails à l'extérieur du caisson du tiroir à l'aide des vis fournies (voir figure A).

STEP 2

Si la cubierta necesita ser recortada, determine el ancho necesario midiendo la distancia fuera de los rieles y retirando 1/4" (Ver Figura B).

Si le couvercle doit être coupé, déterminez la largeur nécessaire en mesurant la distance à l'extérieur des rails et en soustrayant 1/4 po (voir figure B).

STEP 3

Transferir las medidas a la tapa. Para mantener la cubierta centrada en el cajón, divida la medida que necesita recortarse por dos y corte tanto el lado izquierdo como el derecho de la cubierta (consulte la Figura C).

Transférez les mesures sur le couvercle. Pour que le couvercle reste centré dans le tiroir, divisez la mesure qui doit être coupée par deux et coupez les côtés gauche et droit du couvercle (voir figure C).

STEP 4

Corte la cubierta marcando la bandeja varias veces con un cuchillo de uso general con borde recto, y rompa las piezas innecesarias.

Découpez le couvercle en entaillant le plateau plusieurs fois à l'aide d'un couteau tout usage et d'une règle droite et cassez les morceaux inutiles

STEP 5

Deslice la cubierta en los rieles y vuelva a instalar el cajón. La instalación ya está completa (Ver Figura D).

Faites glisser le couvercle dans les rails et réinstallez le tiroir. L'installation est maintenant terminée (voir figure D).

FIG. A

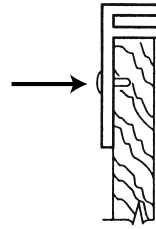

FIG. B

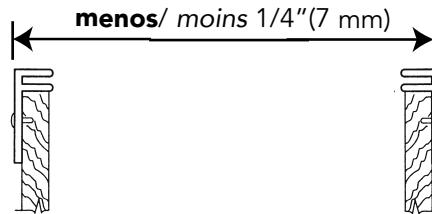

FIG. C

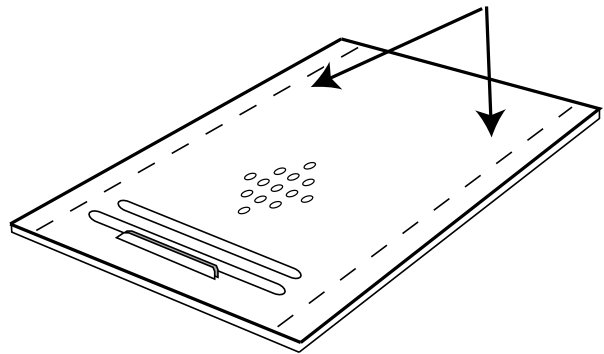

FIG. D

