

# CHANDELIER

## STEP #1

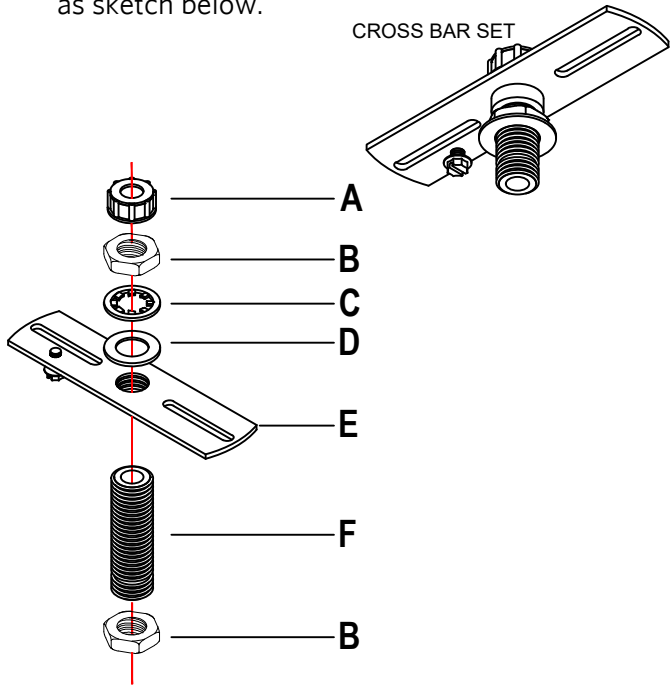







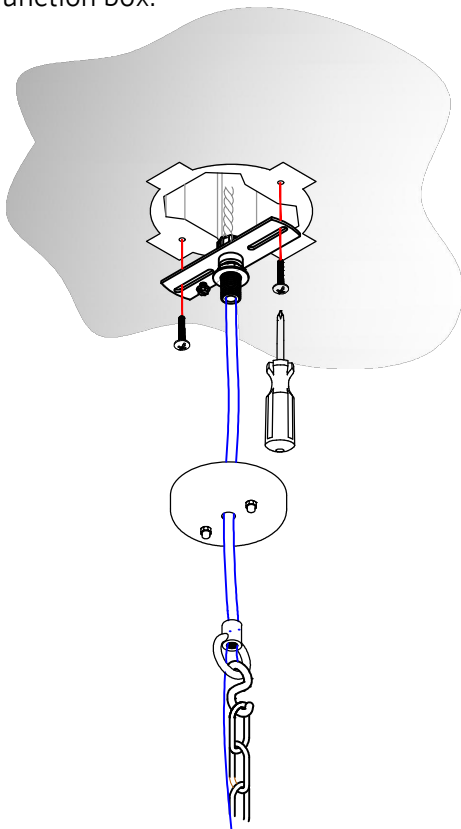

- Open the parts bag and place all on a flat surface.
- Remove the chandelier body and lay on a flat surface.
- Set-up the cross bar according the set of hardware as sketch below.

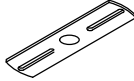

## STEP #2

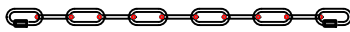
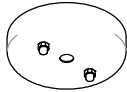
- Insert the electrical wire into the hole of the fixture loop(I), Canopy(H) and into the set of cross bar.
- Set the chandelier near the ceiling surface and Connect the wiring fixture into the junction box. Once the wiring is set then fasten the cross bar into the junction box.

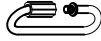
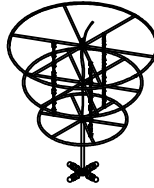

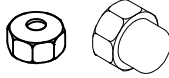
A		BLACK PLASTIC CORD PROTECTOR	
B		HEXAGONAL NUT	
C		SPRING WASHER	
D		PLAIN WASHER	
E		CROSS BAR	
F		LONGER ALL-THREAD	
G		CHAIN	
H		CANOPY	
I		FIXTURE LOOP	
J		QUICK LINK (2PCS)	
K		CHANDELIER	
L		SHADE PLATE	24 PCS
M		MOUNTING NUT & NUT	

### STEP #3

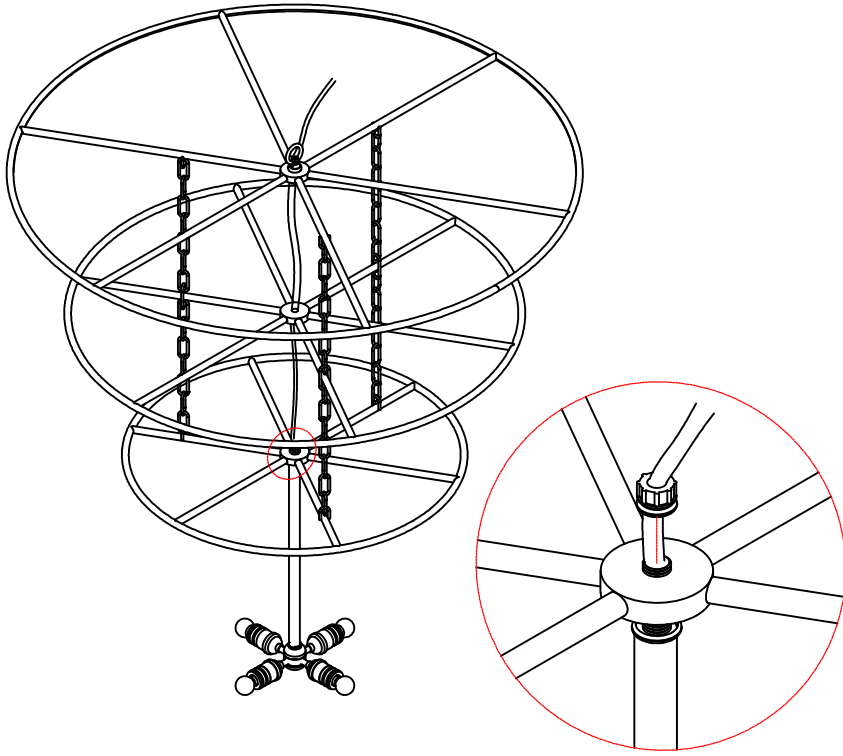

### STEP #4

- Move the canopy against the ceiling surface and screw the fixture loop onto the all thread as shown below.

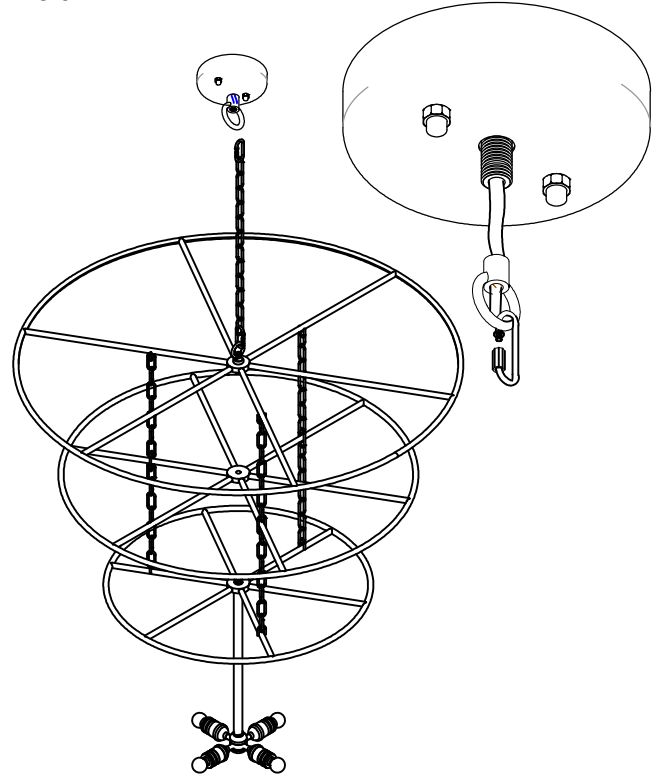

### STEP #5

Attach the shade plate (L) to the cycle frame mounting nuts. See illustrator in below figure.

