

SONDER

LIVING

STORAGE CABINET

Thank you for choosing this quality product. Be sure to check all packaging materials carefully for small parts that may have loosened inside the carton during shipment and place on a non-abrasive surface.

IMPORTANT







These parts can be cumbersome and heavy to some people, therefore, the assistance of two or more people are recommended in order to prevent personal injury and ensure the furniture is not damaged during the assembly Process.

PART LIST

A. [1] SIDEBOARD

B. [3] REMOVABLE SHELF PANELS

HARDWARE LIST

NO	DESCRIPTION	QTY
1	 SHELF PIN	12
2	 PLASTIC BRACKET	4
3	 RESTRAINT STRAP	2
4	 PHILLIPS SCREWS (M4 x 30)	4
5	 PHILLIPS SCREWS (M4 x 20)	4
6	 PLASTIC ANCHOR	4

INSTRUCTIONS

1. Open all the doors then install the shelf pin (1) and place the shelf panels (B) on the shelf pin. See **FIGURE 01**.

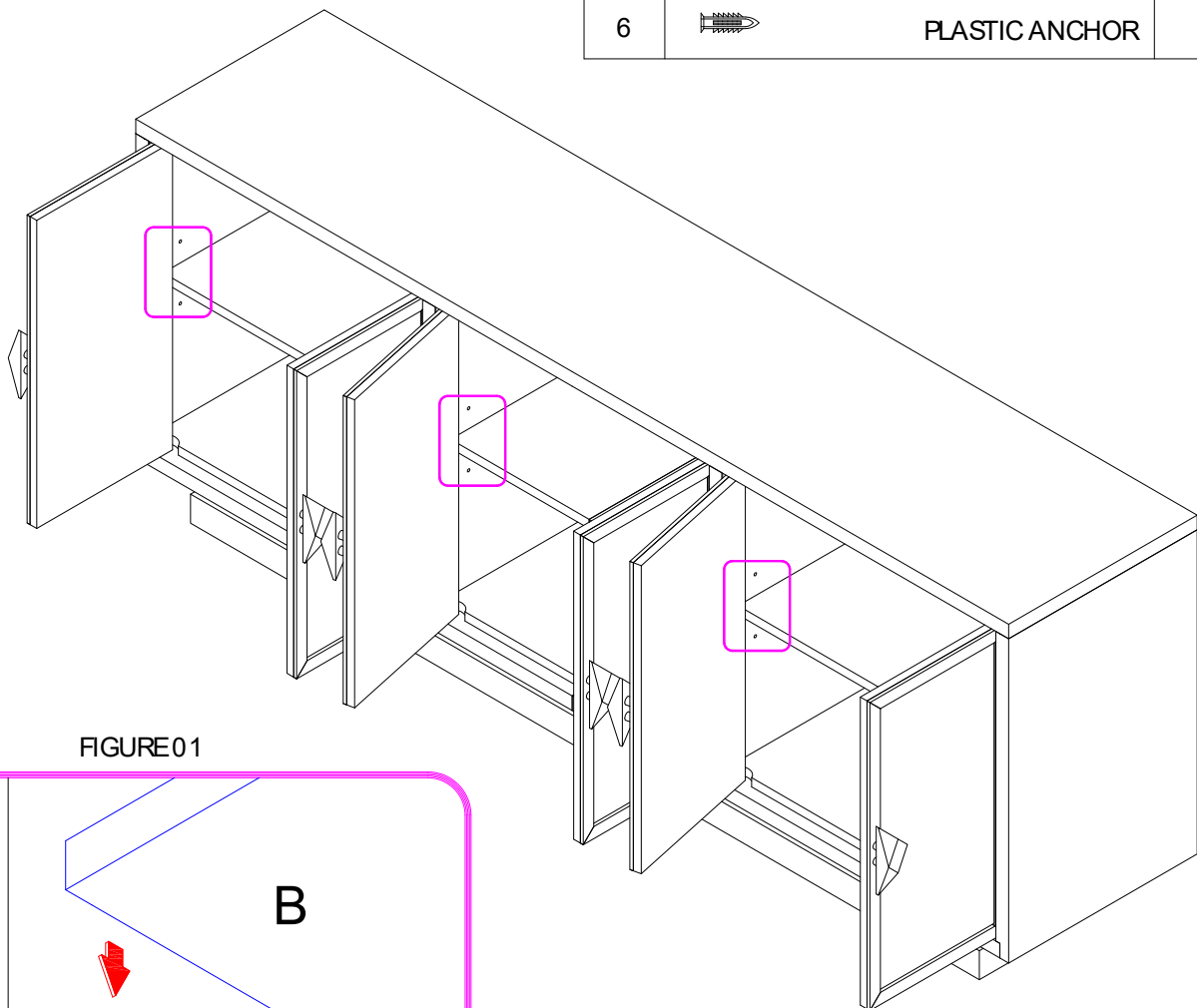
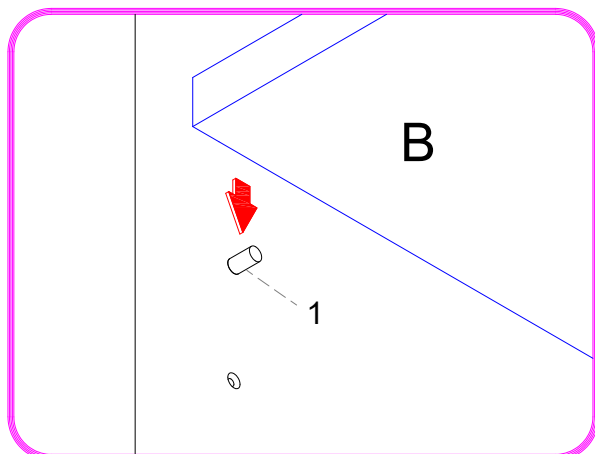

FIGURE 01



FURNITURE TIPPING RESTRAINT INSTRUCTIONS

Young children may be injured by tipping furniture and the use of a tipping restraint is highly recommended. When properly installed, this restraint could provide protection against the unexpected tipping of furniture due to small tremors, bumps or climbing. We recommend mounting this restraint to a wall stud.

WARNING: This product is only a deterrent. It is not a substitute for proper adult supervision.

INSTALLATION INSTRUCTION

1. Attach two of the Plastic Brackets near the top back edge of the furniture piece by inserting the shorter screws.
2. Determine the final position of the furniture piece. Mark locations on the wall approximately 2" below the brackets mounted to the back of the furniture.
3. Drill a shorter hole into the wall stud. If wall stud is not available, drill a hole into the wall and insert Plastic Anchor. Gently tap the Anchor until the flange is flush with the wall.
4. Attach the second set of brackets by inserting the longer screw through the bracket and into the wall.
5. Carefully move the chest backward within 1.5" to 2" from the wall.
6. Place the furniture so that the brackets on the back edge are in line with the brackets in the wall.
7. Lace one end of the nylon restraint strap down through each bracket. Bring both ends together and slide the beaded end until it snap locks into the keyhole slot.
8. To double lock; return the beaded end back through the keyholes.
9. Check to make sure the straps are securely laced and locked to the brackets.

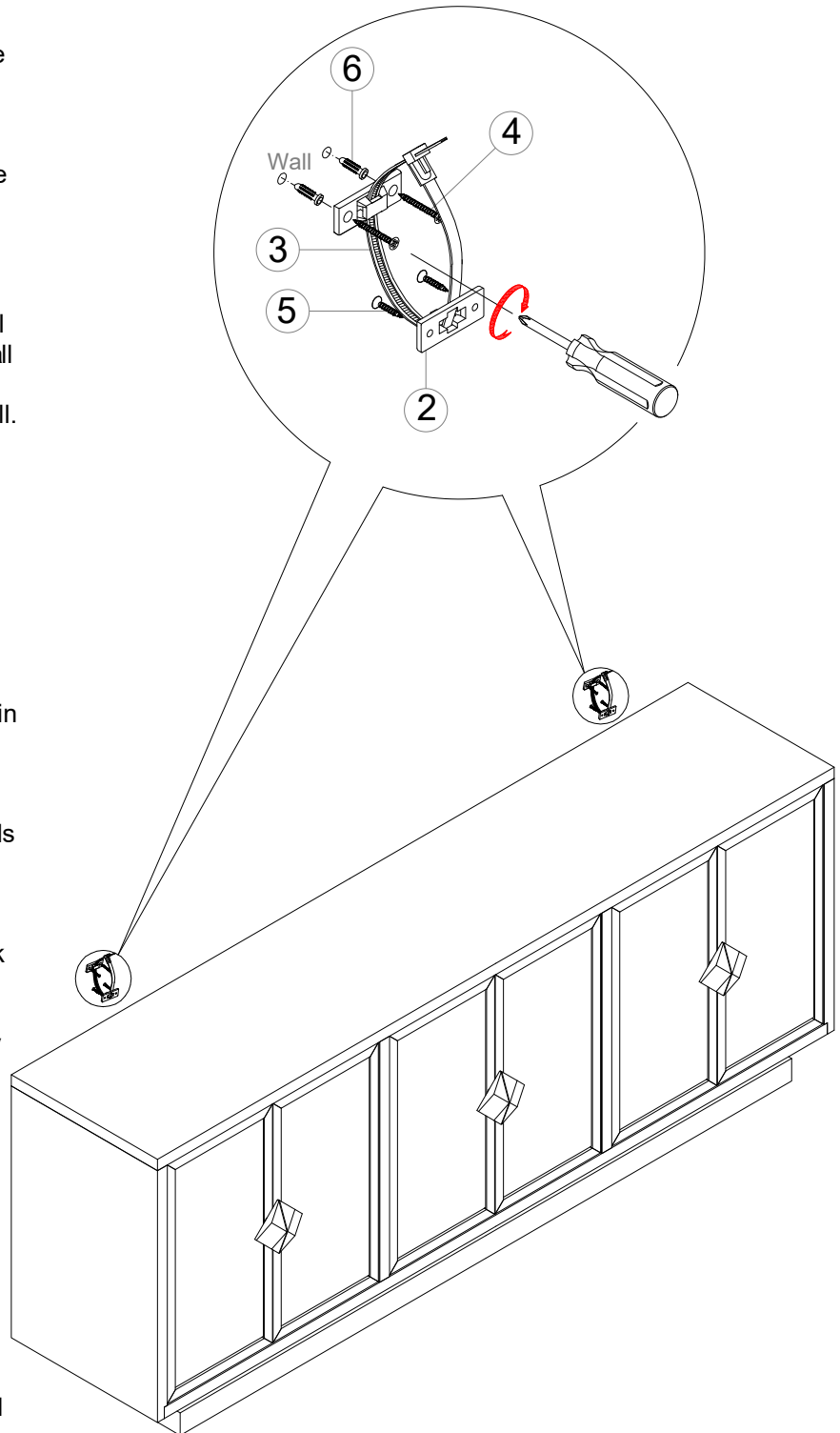

CARE INSTRUCTIONS:

- Dust often using a clean, soft, dry lint-free cloth.
- Blot spills immediately and wipe with a clean, damp, cloth.
- We do not recommend the use of chemical cleansers, abrasives, or furniture polish on our lacquered finish.

Thank you for your purchase