

Albeo® AH2A Series

High Bay Lighting Hazardous Environments



CUSTOMER NAME _____

Project Name _____

Date _____ Type _____

Catalog Number _____

The **Albeo® AH2A** LED fixture offers hazardous location lighting for a variety of demanding environments. Retrofit the Filtr-Gard™ H2 Hazardous Fixture and maintain UL 844 listing. Also, suitable for new construction with purchase of mounting hardware. Perfect for high ambient temperatures & wet locations, the AH2A offers a rugged design with exceptional performance & reliability characteristic of Albeo luminaires.

CONSTRUCTION

Housing:	Low Copper A356 Cast Aluminum
Lens:	Polycarbonate or Tempered Glass
Paint:	Powder coat painted housing.*
Weight:	Up to 19lb (8.62kg)
Optical Assembly:	Reflective optics with flat lens

* No glass in housing or lenses if polycarbonate option is chosen

OPTICAL SYSTEM

Lumens:	5000 - 18000
Distribution:	360°, 180°, or Wide Distribution
Efficacy:	Up to 179 LPW
CCT:	4000K & 5000K
CRI:	70

ELECTRICAL

Input Voltage:	120-277V, 347V or 480V
Input Frequency:	50/60Hz
Power Factor (PF)*:	>90% *
Total Harmonic Distortion (THD)*:	<20%*
EMI:	FCC CFR Title 47 Part 15, Class A
Surge Protection:	10kV/5kA Surge Protection
LED Driver Type:	Class 1

* PF and THD may vary with options

LUMEN AMBIENT TEMPERATURE

TYPE	TEMPERATURE RATE
OPERATING TEMPERATURE	-40°C to +65°C (-40°F to 149°F)
STORAGE TEMPERATURE	-40°C to +70°C (-40°F to 158°F)

LUMEN MAINTENANCE

LXX (10K) @ HOURS 100,000 HR
L70

MOUNTING

- **Typical Mounting:** Designed to retrofit to the existing Current Filtr-Gard™ H2 Hazardous HID mounting kits and maintain UL 844 listing.
- **New Construction:** Pendant Mount, Flexible Pendant Mount, Wall Mount & Stanchion Mount available

Mounting ships separately to allow easy installation flow at the jobsite. Must order mounting kit for new construction installations.

DESIGN LIFE & WARRANTY

- UL1598 Wet Location
- UL1598A Outside Type (Saltwater)
- UL844 Listed
 - Class I Division 2 Groups A, B, C, & D
 - Class II Division 1, Groups E, F, & G (Glass lens only)
 - Class II Division 2, Groups F & G
 - Class III Divisions 1 & 2
 - Simultaneous Presence
- UL8750 LED Equipment in Lighting Products
- CAN/CSA C22.2 No. 137-M1981 Listed
- NEMA 4X Enclosure Type
- IP66 Ingress Protection Rating
- **Current's Limited 5-year Warranty:** Please refer to **ALB048** in Product Downloads section at: <https://products.gecurrent.com>



NEMA
4X
Certified



Albeo® AH2A Series

High Bay Lighting Hazardous Environments

Ordering Information

CUSTOMER NAME

Project Name _____

Date _____ Type _____

Catalog Number _____

Ordering Information :

New Construction = Fixture + mount EX: AH2A005473CNQG + H2000-3P

Retrofit to GE H2 = Fixture only EX: AH2A508571GWQG

AH2A

Q

W

PRODUCT ID	VOLTAGE	LUMEN OUTPUT	CRI	OPTICS	LENS	WIRE GUARD	CONTROL WIRING	FINISH
AH2A = Albeo® HAZARDOUS AH2 1 ST Gen	0 = 120-277V 5 = 480V D = 347V	05 = 5,000lm 08 = 8,000lm 18 = 18,000lm	70 Plus CRI 47 = 4000K 57 = 5000K	3 = 360° 1 = 180° W = 90° Wide	C = Clear Polycarbonate ¹ G = Glass (Tempered) ²	N = None W = Wire Guard	Q = None	G = Gray

ORDERING NOTES:

1. Class II Division 2 only
2. Class II Division 1

70 CRI @ 5000K CCT				
LUMEN PACKAGE	TYPICAL DELIVERED LUMENS	TYPICAL POWER 120-277V	TYPICAL POWER 340-480V	TYPICAL LPW 120-277V
05	5,600	34	37	164
08	8,300	53	57	157
18	18,100	101	102	179

OPTIC CODE	OPTIC DESCRIPTION	OUTPUT
3G	360° Glass	100%
1G	180° Glass	93%
WG	Wide Glass	92%
3C	360° Polycarbonate	98%
1C	180° Polycarbonate	91%
WC	Wide Polycarbonate	90%

MAXIMUM AMBIENT TEMP	5000 LM	8000 LM	18000 LM
45°C	T5	T5	T5
65°C	T4A	T4A	T4A

Temperature Code - Reference Information

Albeo® AH2A Series

High Bay Lighting Hazardous Environments

Mounting/Accessory Options

CUSTOMER NAME _____

Project Name _____

Date _____ Type _____

Catalog Number _____

MOUNTING AND ACCESSORY OPTIONS

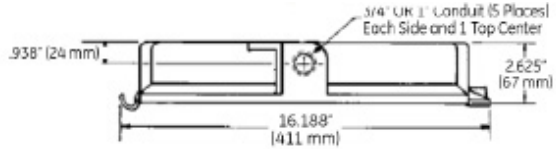
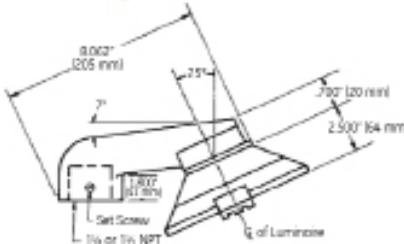
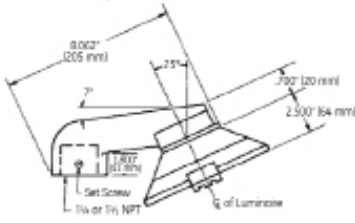
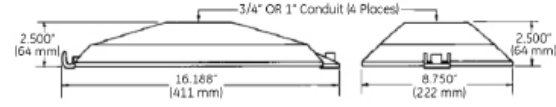
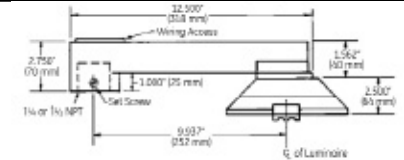
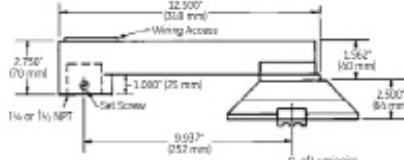
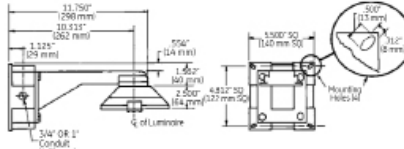
SKU	MOUNTING CAT#	IMAGE	DESCRIPTION	APPROXIMATE NET WEIGHT
210407	H2000-3C		Ceiling Mount 3/4" NPT	3.5 lbs
22277	H2000-5J		Angle Stanchion 1-1/4" NPT	5.0 lbs
16185	H2000-6J		Angle Stanchion 1-1/2" NPT	5.0 lbs
23736	H2000-3P		Pendant 3/4" NPT	3.5 lbs
23065	H2000-5S		Straight Stanchion 1-1/4" NPT	6.7 lbs
16908	H2000-6S		Straight Stanchion 1-1/2" NPT	6.7 lbs
23940	H2000-3W		Wall Mount 3/4" NPT	5.0 lbs

Albeo® AH2A Series

High Bay Lighting Hazardous Environments

Dimensions & Photometrics

CUSTOMER NAME

Project Name _____

Date _____ Type _____

Catalog Number _____

PRODUCT DIMENSIONS

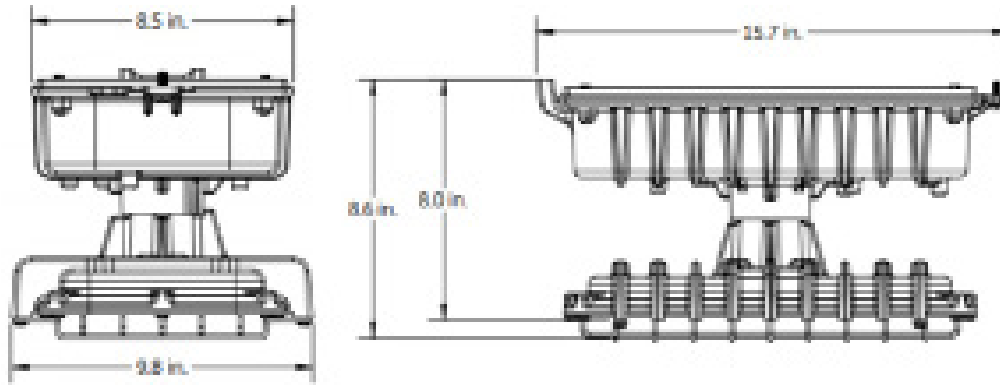

PHOTOMETRIC DATA

3C or 3G
360° Optic

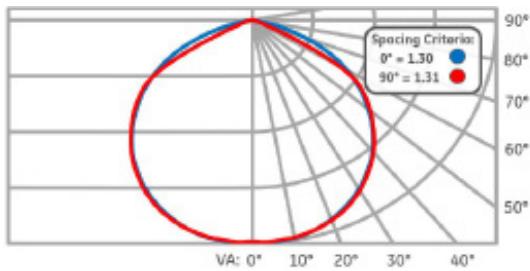

1C or 1G
180° Optic

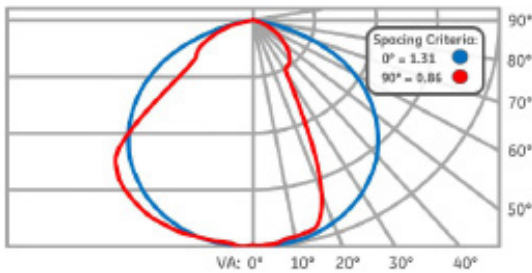

WC or WG
Wide Optic

