



Montage Series

Recessed Multiples | 1x3

The **Montage Series** of luminaires is the ideal recessed counterpart to Tela Mini, sharing the same performance, features and family aesthetic. Available in flange and flange-free configurations, the Montage Series is designed for new construction and retrofit in both T-Grid and hard ceilings.

CONSTRUCTION

Housing:	Die-cast and precision machined head
Lens:	Custom designed spot optical system optimizes CBCP
Optical Assembly:	Silicone optic with high thermal resistance prevents yellowing
Paint:	Textured powder coat finish
Weight:	10.6 lbs. (4.8kg.)

CONTROLS

Standard Dimming: 0–10VDC, Dimming

AMBIENT TEMPERATURE

TYPE	TEMPERATURE RATE
Operating Temperature:	-20C to +30C (-4F to +86F)

OPTICAL SYSTEM

Lumens:	Up to 3960 lumens
Distribution	Spot (15°), Narrow Flood (18°), Flood (25°), Wide Flood (35°)
Efficacy:	Up to 86 LPW
Wattage:	Up to 54 watts
CCT:	2700K, 3000K, 3500K, 4000K
CRI:	80 CRI, 90 CRI

LUMEN MAINTENANCE

LXX(10K) @ HOURS 50,000 HR
L85

MOUNTING

- Standalone rough-in kit for installation in finished and t-grid ceilings.

ELECTRICAL

Input Voltage:	120–277V
Input Frequency:	50/60Hz
Standard Dimming Control:	0–10V, Dimming
Power Factor (PF):	>0.9*
Total Harmonic Distortion (THD):	<20%*

*PF and THD may vary with options

DESIGN LIFE & WARRANTY

- UL Listed and Energy Star rated.
- **Current's Limited 5-year Warranty:** Please refer to [IND599](#) in the Product Downloads section.

CUSTOMER NAME

Project Name _____

Date _____ Type _____

Catalog Number _____

Important: Must order LMM Fixture + LMM Rough-in Kit, Both parts required for complete installation.

FAMILY	FIXTURE TYPE	GENERATION	VOLTAGE	NOMINAL LUMENS	DISTRIBUTION	CRI	CCT	DIMMING	CONTROLS	MOUNTING	FINISH	DIFFUSER	OPTIONS
LMM = Lumination Recessed Mini Multiples	S3 = Semi-Recessed 2 Head R3 = Recessed 2 Head	A = 1 st Generation	0 = 120-277V	09 = 950 Lumens 11 = 1150 Lumens 13 = 1375 Lumens	SP = Spot (15°) NF = Narrow Flood (18°) FL = Flood (25°) WF = Wide Flood (35°)	9 = 90+ CRI	27 = 2700K 30 = 3000K 35 = 3500K 40 = 4000K	V = 0-10V Dimming	Q = None	TR = Trim XT = Trimless	WHITE = White BLCK = Black SLVR = Silver	DXX = None D03 = 3.5° Diffuser D05 = 5° Diffuser D07 = 7.5° Diffuser D10 = 10° Diffuser D20 = 20° Diffuser DL6 = 60° X 10° Diffuser DL3 = 30° X 3° Diffuser	HX = Hexcel SN = Snoot HS = Snoot + Hexcel

CLAIMS - BASED ON 3000K

CONFIGURATION	FIXTURE LUMENS	FIXTURE WATTS	FIXTURE LPW	LUMENS PER HEAD
3-Head, Standard White 09	2850	33	86	950
3-Head, Standard White 11	3450	43	80	1150
3-Head, Standard White 13	3960	54	73	1320

LMM ROUGH-IN KIT

MATERIAL	MATERIAL DESCRIPTION	PRODUCT DESCRIPTION
93039498	LMMRK3A1	LMM Rough-In Kit, 3 Head, 120V
93039503	LMMRK3A4	LMM Rough-In Kit, 3 Head, 277V

FIELD-INSTALLABLE OPTICAL ACCESSORIES

MATERIAL	MATERIAL DESCRIPTION	PRODUCT DESCRIPTION
93026378	LT MDF035	LTM 3.5° Diffuser
93026529	LT MDF05	LTM 5° Diffuser
93026530	LT MDF075	LTM 7.5° Diffuser
93026901	LT MDF10	LTM 10° Diffuser
93026902	LT MDF20	LTM 20° Diffuser
93026903	LT MDF30	LTM 30° Diffuser
93026904	LT MDF6010	LTM 60°x10° Linear Spreader
93026905	LT MDF303	LTM 30°x3° Linear Spreader
93026697	LTMSNWHITE	LTM White Snoot
93026906	LTMSNBLCK	LTM Black Snoot
95019410	LTMSNSLVR	LTM Silver Snoot
93026696	LTMHX	LTM Hexcel Louver

CUSTOMER NAME

Project Name _____

Date _____ Type _____

Catalog Number _____

TRIM

SEMI-RECESSED

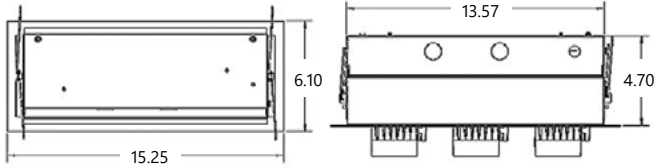

TRIMLESS

SEMI-RECESSED

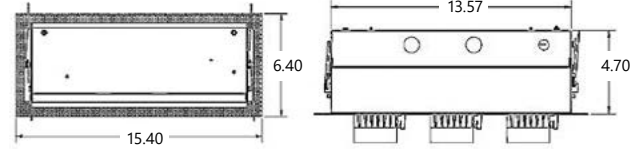

FULLY-RECESSED

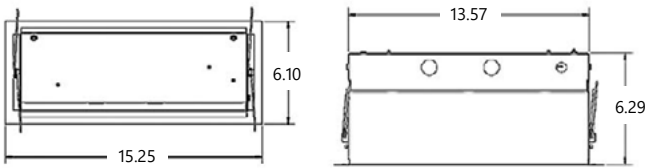

FULLY-RECESSED

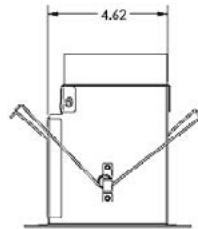
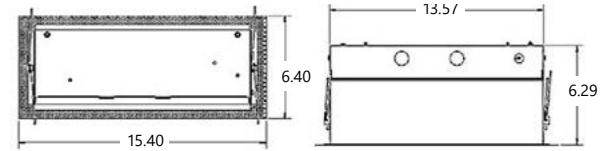

Width is same for both
Semi-Recessed and Fully-Recessed

ROUGH-IN KIT INFORMATION

MATERIAL	MATERIAL DESCRIPTION	PRODUCT DESCRIPTION
93039498	LMMRK3A1	LMM Rough-In Kit, 3 Head, 120V
93039503	LMMRK3A4	LMM Rough-In Kit, 3 Head, 277V

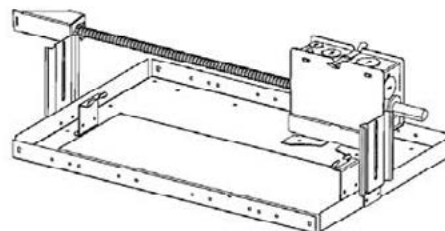
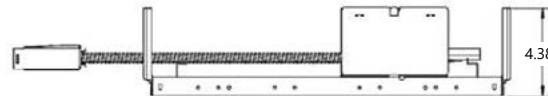
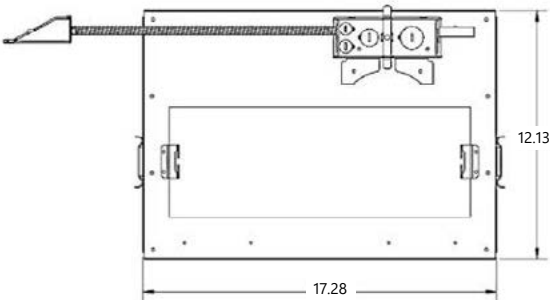

CUSTOMER NAME

Project Name _____

Date _____ Type _____

Catalog Number _____

20 Watt
1320 Lumens per head

Spot Flood Distribution
15° Beam

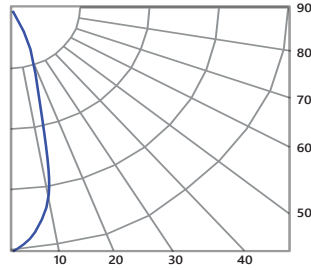

CANDLEPOWER SUMMARY	
Angle	Candela
0	12243
5	9730
15	1059
25	102
35	62
45	26
55	15

CONE OF LIGHT		
Height	fc	Dia. (ft)
6	340	1.7
8	191	2.3
10	123	2.9
12	85	3.5
14	62	4.1
16	48	4.6

20 Watt
1320 Lumens per head

Narrow Flood Distribution
18° Beam

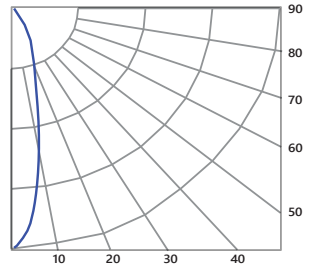

CANDLEPOWER SUMMARY	
Angle	Candela
0	8919
5	7045
15	1478
25	188
35	77
45	39
55	21

CONE OF LIGHT		
Height	fc	Dia. (ft)
6	248	2.0
8	139	2.7
10	89	3.4
12	62	4.0
14	45	4.7
16	35	5.4

20 Watt
1320 Lumens per head

Flood Distribution
25° Beam

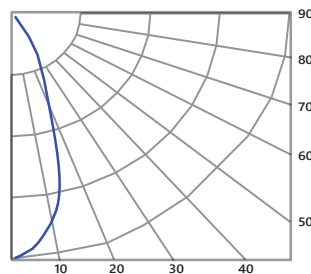

CANDLEPOWER SUMMARY	
Angle	Candela
0	4893
5	4638
15	2291
25	439
35	135
45	60
55	30

CONE OF LIGHT		
Height	fc	Dia. (ft)
6	136	2.8
8	77	3.8
10	49	4.7
12	34	5.7
14	25	6.6
16	19	7.6

STANDARD LED CONVERSION TABLE

Lumen and CBCP output varies based on Wattage, CCT and CRI. Table below is based on 3000K, 80 CRI fixture. To estimate lumen and CBCP output of other combinations, multiply photometric data by factors below.

827	830	835	840	927	930	935	940
0.95	1	1.03	1.05	0.8	0.83	0.85	0.87

For Product or Technical Questions:

E: lightingproinfo@gecurrent.com
T: +1 888 694 3533, OPTION 2