



IMPORTANT SAFEGUARDS

WHEN USING ELECTRICAL EQUIPMENT, BASIC SAFETY PRECAUTIONS SHOULD ALWAYS BE FOLLOWED, INCLUDING THE FOLLOWING:

WARNING:

1. Risk of electrical shock. Disconnect power at the fuse or circuit breaker before installing or servicing.
2. To prevent early lamp failure, lamps should only be installed in operating environments ranging between -4°F and 104°F (-20°C and 40°C).
3. To prevent overheating, do not install totally enclosed recessed fixtures.
4. No user-serviceable parts are inside. To avoid electrical shock, do not disassemble the product.
5. This product is not intended for use in emergency light fixtures or exit signs.
6. Risk of fire or electrical shock. Install this kit only in luminaires that have the construction features and dimensions shown in the photographs and/or drawings.
7. Do not make or alter any open holes in an enclosure of wiring or electrical components during kit installation.
8. Do not expose wiring to the edges of sheet metal or other sharp objects to prevent wiring damage or abrasion.
9. Do not use this equipment for anything other than its intended use.
10. Disconnect power before installing the product or servicing it.
11. Wait until the fixture has cooled down before installing or servicing it.

CAUTION:

1. Turn the power off before inspection, installation, or removal.
2. Suitable for dry, and damp locations.
3. Use only on 120Vac, 60Hz circuits.

SAVE THESE INSTRUCTIONS

READ AND FOLLOW ALL SAFETY INSTRUCTIONS

What's In The Box

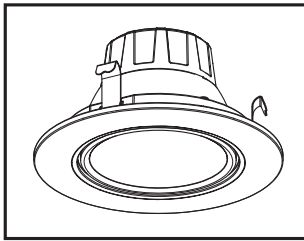

One (1) DCG4v3

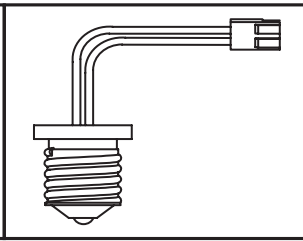

One (1) Edison Adaptor

Materials Needed

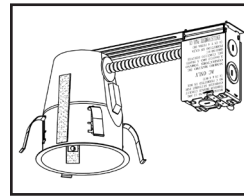

4" Housing

Tools Needed

The DCG4 Recessed LED Downlight is designed to fit into most of 4" housing. No tools are necessary for installation.

Installing the DCG4



Make sure all power is turned off before beginning installation

1 Carefully unpack the downlight from its packaging. Inspect product for defects due to shipping.

2 Check if the 4-inch housing has the minimum lamp compartment measurements as shown in the image on the side to ensure the fixture will fit and be free from other obstruction.

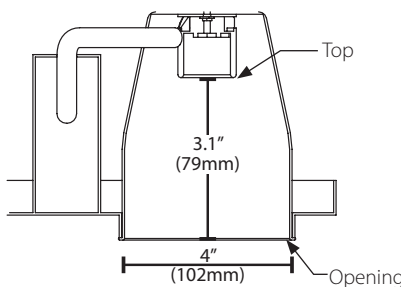

3 Disconnect Edison base from downlight and screw into socket inside recessed housing. (GU24 base option available).

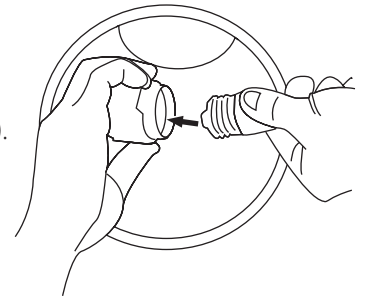

4 Use the switch on the driver box to select the desired CCT.

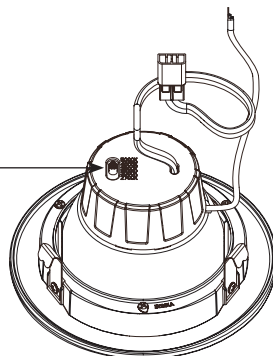
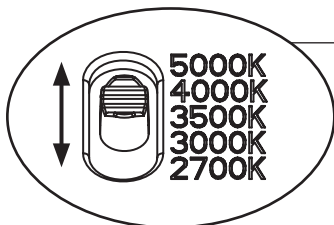

5 Plug the downlight connector into the Edison (or GU24) base connector. Ensure the ground wires are secured.

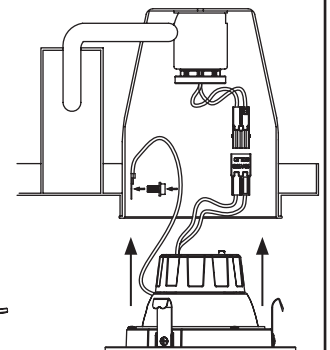
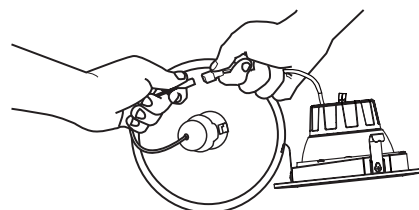

- 6** Align friction clips with the recessed housing. Guide the fixture into the housing for a tight fit.

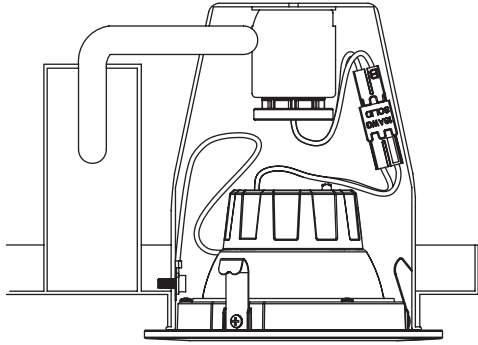

- 7** Carefully route wires into the housing and push the downlight upward, flush with the ceiling surface.

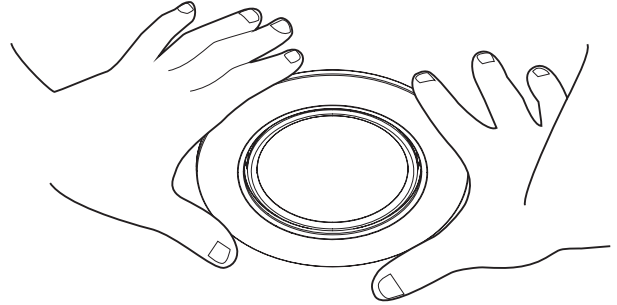

GIMBAL FEATURE:

The gimbal can tilt up to 30 degrees vertically and rotate 350 degrees horizontally.

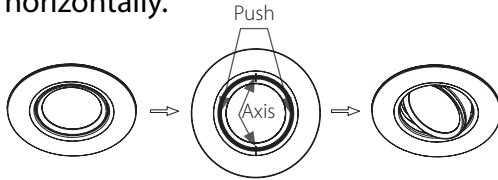

Tilt from
0° - 30°

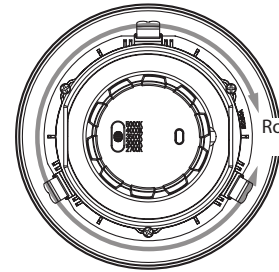
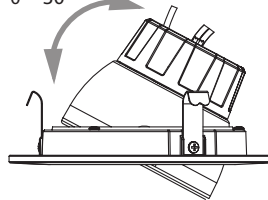

Rotation up
to 350°

EXPRESS LIMITED WARRANTY

Subject to the exclusions contained below, NICOR Inc. (NICOR) warrants that all NICOR LED branded Solid State Lighting products made by NICOR to be free from defects in materials and workmanship, under normal consumer usage for a period of 5 years from date of purchase. This limited warranty is a consumer's exclusive remedy, and applies only to new products purchased and used by consumers in the United States or Canada, which are accompanied by this written warranty.

This limited warranty extends only to the first consumer purchaser, and is not transferable. A consumer wishing to invoke the terms of this warranty must first obtain a RGA number within 30 days of discovery of the defect, and return the product to NICOR for inspection. Once verified to be covered by this limited warranty, NICOR will, at its discretion, repair, replace or refund the purchase price of any product that does not conform to this limited warranty.

This limited warranty covers only defects in material and workmanship associated with normal installation and intended use of the product.

THIS LIMITED WARRANTY DOES NOT COVER THE FOLLOWING:

- Defects or damages resulting from improper operation, storage, misuse or abuse, accident or neglect;
- Defects or damages resulting from improper service, testing, adjustment, installation, maintenance, alteration, connection to out-of-specification electrical service, corrosive or damp environments, or connection to incompatible equipment or devices (e.g., connecting non-dimmable lighting products to dimmers);
- Damage which occurs in transit; and
- Labor or other charges or expenses associated with the removal, repair, or re-installation of defective or replacement products.

ANY IMPLIED WARRANTIES, INCLUDING WITHOUT LIMITATION, THE IMPLIED WARRANTIES OF MERCHANTABILITY AND FITNESS FOR A PARTICULAR PURPOSE SHALL BE LIMITED TO THE DURATION OF THIS LIMITED WARRANTY, OTHERWISE THE REPAIR, REPLACEMENT OR REFUND AS PROVIDED UNDER THIS EXPRESS LIMITED WARRANTY IS THE EXCLUSIVE REMEDY OF THE CONSUMER, AND IS PROVIDED IN LIEU OF ALL OTHER WARRANTIES, EXPRESS OR IMPLIED. IN NO EVENT SHALL NICOR BE LIABLE, WHETHER IN CONTRACT OR IN TORT (INCLUDING NEGLIGENCE) FOR DAMAGES IN EXCESS OF THE PURCHASE PRICE OF THE PRODUCT, OR FOR ANY INDIRECT, INCIDENTAL, SPECIAL OR CONSEQUENTIAL DAMAGES OF ANY KIND, OR LOSS OF REVENUE OR PROFITS, LOSS OF BUSINESS OR OTHER FINANCIAL LOSS ARISING OUT OF OR IN CONNECTION WITH THE ABILITY OR INABILITY TO USE THE PRODUCT TO THE FULL EXTENT THESE DAMAGES MAY BE DISCLAIMED BY LAW.

Copyright 2016, NICOR, Inc., Revised February, 2016

This device complies with part 15 of the FCC Rules. Operation is subject to the following two conditions: (1) This device may not cause harmful interference, and (2) this device must accept any interference received, including interference that may cause undesired operation.

NOTE: This equipment has been tested and found to comply with the limits for a Class B digital device, pursuant to part 15 of the FCC Rules. These limits are designed to provide reasonable protection against harmful interference in a residential installation. This equipment generates, uses and can radiate radio frequency energy and, if not installed and used in accordance with the instructions, may cause harmful interference to radio communications. However, there is no guarantee that interference will not occur in a particular installation. If this equipment does cause harmful interference to radio or television reception, which can be determined by turning the equipment off and on, the user is encouraged to try to correct the interference by one or more of the following measures:

- Reorient or relocate the receiving antenna.
- Increase the separation between the equipment and receiver.
- Connect the equipment into an outlet on a circuit different from that to which the receiver is connected.
- Consult the dealer or an experienced radio/TV technician for help.